

# SES70 Intelligent Earthquake Sensor

## User's Manual for System Design



**Thank you for purchasing an Azbil Corporation product.**

**This manual contains information for ensuring the correct use of this product. It also provides necessary information for installation, maintenance, and troubleshooting.**

**This manual should be read by those who design and maintain equipment that uses this product. Be sure to keep this manual nearby for handy reference.**

Azbil Corporation

## **NOTICE**

---

---

Be sure that the user receives this manual before the product is used.

Copying or duplicating this user's manual in part or in whole is forbidden. The information and specifications in this manual are subject to change without notice.

Considerable effort has been made to ensure that this manual is free from inaccuracies and omissions. If you should find an error or omission, please contact the azbil Group.

In no event is Azbil Corporation liable to anyone for any indirect, special or consequential damages as a result of using this product.

---

---

© 2015–2017 Azbil Corporation All Rights Reserved.

SES™ is a trademark of Azbil Corporation in Japan.

## Conventions Used in This Manual

- The safety precautions explained in the following section aim to prevent injury to the operator and others, and to prevent property damage.

 **WARNING** Warnings are indicated when mishandling this product might result in death or serious injury.

 **CAUTION** Cautions are indicated when mishandling this product might result in minor injury to the user, or physical damage to the product.

- In describing the product, this manual uses the icons and conventions listed below.

 Use caution when handling the product.

 The indicated action is prohibited.

 Always follow the indicated instructions.

### Handling Precautions:

Handling Precautions indicate items that the user should pay attention to when handling this product.

 **Note:** Notes indicate information that might benefit the user.

(1), (2), (3): Numbers within parentheses indicate steps in a sequence or parts of an explanation.

 This indicates the item or page that the user is requested to refer to.

## Label and seal

The following nameplate, label, and seal are attached to this unit.

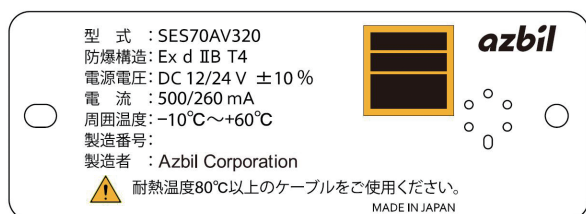

Rating nameplate



Warning label











Seal

## Safety Precautions





Safety precautions are intended to ensure the safe and correct use of this product, to prevent injury to the operator and others, and to prevent damage to property. Be sure to observe these safety precautions. Please make sure you understand the safety guidelines before reading the rest of this manual.

The use of this product in a manner not specified by the manufacturer will impair its built-in safety features.















### **WARNING**

- |   |   |
|---|---|
|    | <b>For explosion-proof instrumentation, install and wire this unit in accordance with the National Institute of Industrial Safety's "User's Guidelines for Electrical Installations for Explosive Gas Atmospheres in General Industry" (Tokyo, 1994 [in Japanese]).</b> |
|    | <b>This device is certified as a pressure-resistant explosion-proof construction (Ex d IIC T4). Install it in a location that complies with this certification.</b>   |
|    | <b>If there might be an explosive atmosphere, do not open the cover. Doing so may cause explosion or fire.</b>  |
|    | <b>If you use the Smart Loader Package (sold separately), do so in a non-hazardous area where there is no danger of explosion or fire.</b>  |
|   | <b>Always use the cable gland and flameproof packing set supplied with this unit. In addition, use packing that is appropriate for the cable. If the wrong packing is used, the unit will no longer be a certified explosion-proof product.</b>                         |
|  | <b>Use cables with a heat resistance to temperatures of 80 °C or more. If a cable with a heat resistance of less than 80 °C used, the unit will no longer be a certified explosion-proof product. Moreover, fire or device failure may result.</b>                      |
|  | <b>After wiring work, be sure to firmly tighten the cover screws. Otherwise the unit will not satisfy the conditions for a pressure-resistant explosion-proof construction.</b>   |
|  | <b>Before doing wiring work, be sure to disconnect the power. Failure to do so may result in an electric shock.</b>   |
|  | <b>If the cover is open in a hazardous area, do not turn on the electricity. Doing so may cause explosion or fire.</b>  |

### **CAUTION**

- |   |  |
|---|--|
|  | <b>Only specialists with the proper knowledge and technical skill concerning this type of equipment and this unit should carry out the installation, wiring, inspection, and maintenance work.</b> |
|  | <b>This device does not incorporate any countermeasures against lightning. As necessary, take appropriate measures to protect equipment from lightning.</b>  |
|  | <b>Do not use a walkie-talkie or other transceiver within 2 m of this unit or cables connected to this unit. Doing so may cause this unit to malfunction.</b>                                      |
|  | <b>Use shielded cables for wiring.</b>   |
|  | <b>Be sure to carry out the wiring work properly. Incorrect wiring may cause device failure.</b>   |

## CAUTION

	Do not allow crimp terminals (etc.) to come into contact with adjacent terminals. Doing so may cause fire or device failure.
	For control of critical equipment (e.g., for earthquake emergency shutdown), to avoid dependence on a single output, use this earthquake sensor together with another one, or use a 2-out-of-3 configuration.
	If this unit malfunctions, its electrical output may be incorrect. If equipment safety might thereby be endangered, consider having a fail-safe design for the system as a whole, with compartmentalization of controller and limits and with duplexing or use a redundant design.
	Interference from a shock wave or electromagnetic wave may activate the noise protection function of this unit, preventing vibration detection output or AO/DO output.
	Handle the case and cover with care. If the threads are damaged, the cover will not open and close properly.
	Do not subject this device to shock that exceeds the operating conditions stated in the specifications. Doing so may cause device failure.
	This device is a precision instrument. Impact from a 1 cm fall is enough to damage the internal sensor.
	Be sure to handle it carefully. Take care to prevent impact when removing this unit from the box, placing it on the floor temporarily during installation, etc.
	During installation, take care not to bump this device against metal objects such as pipes at the work site.
	When connecting the wiring, be sure not to hit the sensor with a crimping tool, screwdriver, or other tool.
	When tightening the cable gland with a wrench, do not hit the wrench with a hammer.
	If there is a risk of impact to this unit after it is mounted, install a protective cover or like.
	Do not disassemble or modify this device.
	Do not subject this unit to impact or shock from a wrench or the like when removing the unit for periodic inspection, etc.
	When sending this unit back to Azbil Corporation for periodic inspection, pack it in the shipping package specially made for it. Contact the azbil Group for the shipping box.

### Handling Precautions

- Do not remove the seal from the cable gland connection port until the wiring work is about to begin.



取扱注意

HANDLE WITH CARE

Dikkatli taşıyınız, kırılabilir

小心輕放

小心轻放

취급주의

This unit withstands an impact of  $490 \text{ m/s}^2$  (50 G). Because this device is a precision instrument, handle it with care. Two metal objects knocking together can create an impact of several tens of thousands of  $\text{m/s}^2$  (several thousands of Gs).

### ⊘ Prohibited actions

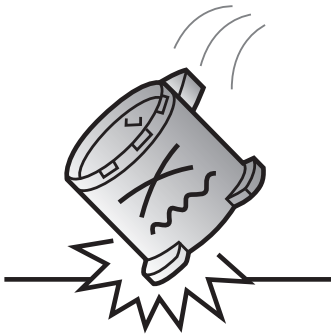

(1) Dropping the unit on the floor



(2) Casually putting the unit down on a table or stand (put it down gently)

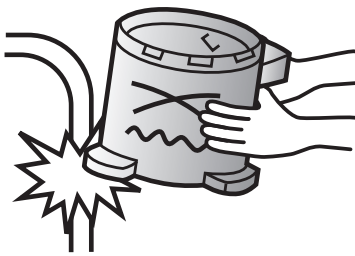

(3) Bumping the unit against pipes, etc.



(4) Striking the unit with a tool

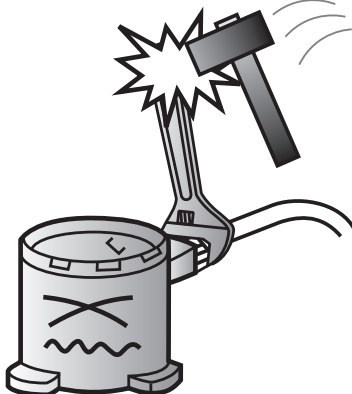

(5) Hitting a tool (during installation or wiring)

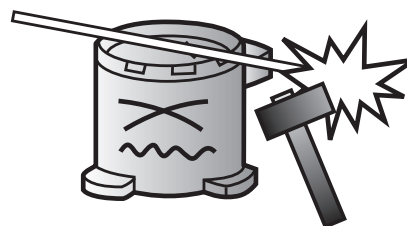

(6) Hitting the tool (to open the cover)

# The Role of This Manual

There are four different manuals related to the SES70. Read them as necessary for your specific requirements. If a manual you require is not available, contact the azbil Group or its dealer.

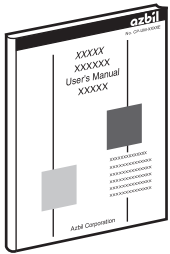

## **SES70 Intelligent Earthquake Sensor User's Manual for System Design** **Manual No. CP-SP-1376E**

This manual.

First-time users of the SES70 and those designing or maintaining hardware that uses the SES70 should read this manual thoroughly. This manual gives an overview and hardware specifications, and describes installation, wiring, setup, operation, and troubleshooting.

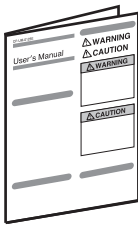

## **SES70 Intelligent Earthquake Sensor User's Manual** **Manual No. CP-SP-1393E**

This manual is supplied with the SES70. Personnel in charge of the installation or wiring of this device, or in charge of the design or maintenance of hardware that uses this device, should read this manual thoroughly. The manual gives an overview of this device and describes installation methods, wiring, startup preparation, and troubleshooting.

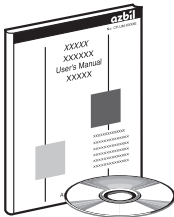

## **SLP-SE7 Smart Loader Package for SES70 Intelligent Earthquake Sensor** **Manual No. CP-SP-1394E**

This manual is included on the SLP-SE7 installation disk. After installation, personnel in charge of settings or in charge of monitoring the device's operation should read this manual thoroughly. The SLP-SE7 is used for monitoring and configuration of the SES70 on a PC. The manual describes installation on a PC, loader functions, and loader operation.

# Organization of This User's Manual

---

This manual is organized as follows.

**Chapter 1. OVERVIEW**

Features and models

**Chapter 2. NAMES AND FUNCTIONS OF PARTS**

Names and functions of parts

**Chapter 3. INSTALLATION**

Installation methods, important notes, and locations

**Chapter 4. WIRING**

Wiring procedures, connection examples, and precautions for wiring

**Chapter 5. PREPARATIONS FOR START-UP**

What to check before use and how to set the time

**Chapter 6. INTERNAL PROCESSING**

Basic operation modes, calculations, control output, waveform recording, and error diagnosis

**Chapter 7. LOADER ACCESS DATA**

Data accessed by the SLP-SE7 from a PC (For details on the loader, see SLP-SE7 Smart Loader Package for SES70 Intelligent Earthquake Sensor, No. CP-UM-5756E.)

**Chapter 8. MAINTENANCE AND TROUBLESHOOTING**

Troubleshooting and Countermeasures

**Chapter 9. DISPOSAL**

Disposal

**Chapter 10. SPECIFICATIONS**

General specifications, performance specifications, and external dimensions

**APPENDIX**

Glossary and method of determining acceleration accuracy



# Contents

---

<b>Conventions Used in This Manual</b>	
<b>Safety Precautions</b>	
<b>The Role of This Manual</b>	
<b>Organization of This User's Manual</b>	

<b>Chapter 1. OVERVIEW</b>	<b>1-1</b>
■ Application	1-1
■ Features	1-2
■ Model selection	1-3
<b>Chapter 2. NAMES AND FUNCTIONS OF PARTS</b>	<b>2-1</b>
■ Names of parts	2-1
■ Basic function block diagram	2-1
■ Internal structure	2-2
■ Measurement principles	2-2
<b>Chapter 3. INSTALLATION</b>	<b>3-1</b>
■ Installation Location	3-1
■ Installation Instructions	3-1
<b>Chapter 4. WIRING</b>	<b>4-1</b>
■ Wiring Procedure	4-2
■ Connecting the battery	4-6
■ Lightning surge protection	4-6
<b>Chapter 5. PREPARATIONS FOR START-UP</b>	<b>5-1</b>
■ Procedure for setting the clock	5-1
<b>Chapter 6. INTERNAL PROCESSING</b>	<b>6-1</b>
6-1 Modes	6-1
■ Mode transition	6-1
■ Functions of the modes	6-2
6-2 Internal Calculation Processes	6-7
■ Internal Calculation	6-7
■ Various calculations and judgment processes	6-8
■ SI calculation	6-10
■ Synthesized AC acceleration calculation	6-11

	■ Calculation of the JMA seismic intensity scale equivalent value .....	6-12
	■ Relationship of the JMA scale (shindo scale), acceleration, SI value, and measured seismic intensity (shindo) .....	6-12
	■ Noise protection process .....	6-12
6-3	<b>Waveform Recording</b> .....	6-13
	■ Waveform recording header information .....	6-13
	■ Automatic waveform recording .....	6-13
	■ Example of maximum value recording without trigger update .....	6-15
	■ Example of maximum value recording with trigger update .....	6-17
	■ Example of threshold value recording .....	6-19
	■ Forced waveform recording .....	6-21
	■ Example of waveform recording .....	6-21
6-4	<b>Vibration Detection and Liquefaction Judgment Functions</b> .....	6-22
	■ Vibration detection judgment function .....	6-22
	■ Liquefaction judgment function .....	6-22
6-5	<b>Noise Protection Function</b> .....	6-24
6-6	<b>Error Diagnosis Functions</b> .....	6-26
	■ Failure level standards .....	6-26
	■ Diagnostic functions according to the mode .....	6-27
	■ Various error diagnosis functions .....	6-27
6-7	<b>Output Functions</b> .....	6-29
	■ Output update and hold processes .....	6-29
	■ Hold process .....	6-29
	■ Manual output .....	6-30
	■ Output adjustment (constant drift) .....	6-31
	■ Output adjustment (high-frequency noise) .....	6-31
	■ Output selection .....	6-32
	■ Outputs according to mode .....	6-33
6-8	<b>Maintenance Sequence</b> .....	6-34
	■ Maintenance sequence .....	6-34
6-9	<b>LED Output Functions</b> .....	6-36

## **Chapter 7. LOADER ACCESS DATA** .....

	■ Real-time data monitoring data .....	7-1
	■ Changing of settings .....	7-2
	■ Waveform recording .....	7-6
	■ Manual output function .....	7-6
	■ Diagnosis and adjustment function .....	7-8

## **Chapter 8. MAINTENANCE AND TROUBLESHOOTING** .....

	■ Checklist for periodic inspection .....	8-1
	■ How to replace the battery .....	8-1
	■ Troubleshooting .....	8-2

---

<b>Chapter 9. DISPOSAL</b> .....	<b>9-1</b>
<b>Chapter 10. SPECIFICATIONS</b> .....	<b>10-1</b>
10-1 Specifications .....	10-1
10-2 Performance Specifications .....	10-3
10-3 Other Specifications .....	10-4
■ Communication specifications .....	10-4
■ External dimensions .....	10-4
<b>APPENDIX</b> .....	<b>App-1</b>
■ Glossary .....	App-1
■ Method of determining acceleration accuracy .....	App-2
■ Relationships between JMA seismic intensity, acceleration, SI value, and measured JMA seismic intensity .....	App-5

# Memo

---

# Chapter 1. OVERVIEW

## ■ Application

The SES70 Intelligent Earthquake Sensor calculates seismic intensity (SI), which represents estimated structural damage, and the Japan Meteorological Agency (JMA) seismic intensity scale (shindo scale) equivalent value, based on acceleration signals generated from the built-in accelerometer.

Additionally, the unit judges ground liquefaction from the acceleration waveform characteristics, and outputs the results.

### ● Application examples

#### 1. Earthquake emergency shutdown and remote monitoring system

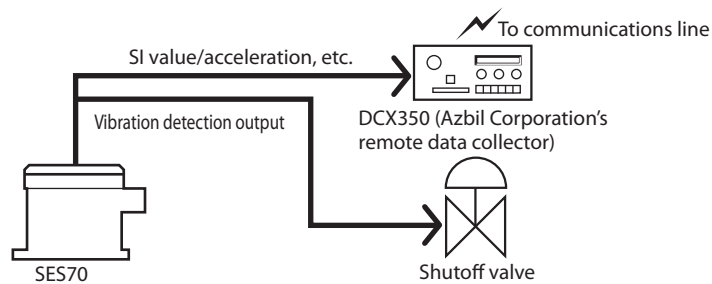

#### 2. Earthquake monitoring system

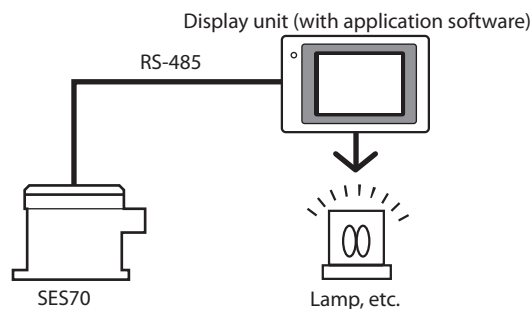

#### 3. Earthquake monitoring with 2-out-of-3 shutdown system

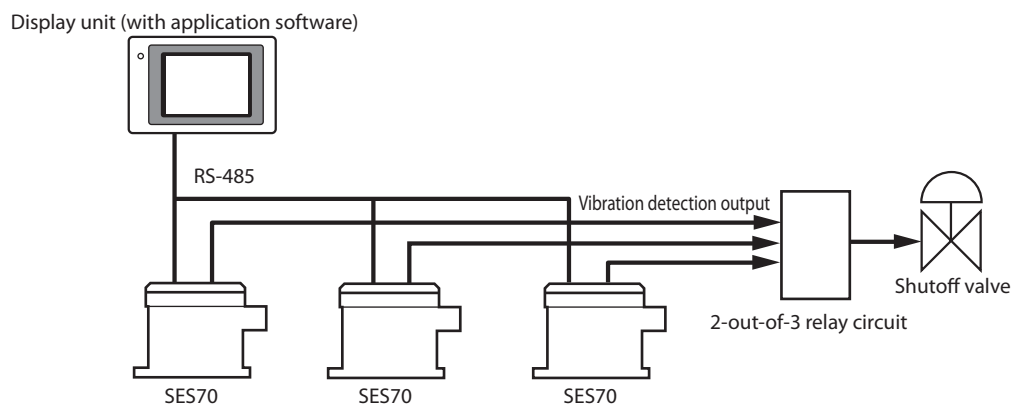

To create a redundant system, take into account the following:

- If electrical noise is expected, keep wiring away from sources of noise.
- If interference from other vibration or shock is expected, install the SES on a foundation separated as far as possible from the source of the vibration or shock.

---

## ■ Features

The SES70 calculates seismic intensity (SI), which represents estimated structural damage, and the JMA seismic intensity scale equivalent value, based on acceleration signals generated from the built-in accelerometer, and it can output the results. Additionally, the unit can judge ground liquefaction from the acceleration waveform characteristics, and can output the results.

Other features are shown below:

- Thanks to the 3 axes (north-south, east-west, and up-down = X, Y, Z) of the servo accelerometer, high-accuracy acceleration measurement is possible by characterization of the acceleration waveforms.
- Two independent acceleration values are available for different purposes, either calculation or control. A filter coefficient and the number of axes for synthesized AC acceleration can be set individually for acceleration values.
- The unit synthesizes acceleration signals as vectors and, based upon the maximum value within the time window, it calculates the synthesized AC acceleration for calculation and the synthesized AC acceleration for control. The synthesized AC acceleration selected for the PV can be output as a 4–20 mA analog signal.
- By vector projection of the AC acceleration for calculation signals in 8 directions in a horizontal plane, the unit executes a speed response calculation in 8 directions in real time. The maximum value obtained within the time window is output as the SI value. The SI value can be output as a 4–20 mA analog signal.
- Regarding SI calculation, in addition to speed response calculation in 8 directions (7 natural periods), calculation in 16 directions (24 natural periods) can be chosen. The selected SI values are used for the PV, vibration detection judgment, waveform recording, analog output (AO), etc.
- The JMA shindo earthquake scale is calculated with an approximate formula that uses the SI value and the synthesized AC acceleration for calculation. The resulting JMA seismic intensity scale equivalent value can be output as a 4–20 mA analog signal.
- The liquefaction detection algorithm, which uses a horizontal 2-axis calculation AC, detects the occurrence of liquefaction. When it is detected, the liquefaction detection output turns ON.
- The automatic waveform recording function can record ten 360-second waveforms of 3-axis acceleration signals at a 10 ms sampling cycle when triggered by the synthesized AC acceleration value for calculation, the SI value, or the JMA seismic intensity scale equivalent value for the measured vibration waveforms. The recorded waveform signals can also be read on a PC using the loader.
- The automatic waveform recording function can operate on the basis of maximum value recording with trigger update, maximum value recording without trigger update, or threshold value recording.
- The forced waveform recording function can record one waveform for 360 s using the loader.
- Waveform files record the following header information: trigger time, SI value of the recorded waves, synthesized AC acceleration value for calculation, JMA seismic intensity scale equivalent value, maximum Sv value of the 7 selected natural periods in the waveform records, and checksum value for the waveform data. This information can be read out via communications.

- The vibration detection contact output signals turn ON according to the results of calculation and according to the following four conditions with AND or OR relationships:
  - When the SI value exceeds the preset value
  - When the JMA seismic intensity scale equivalent value exceeds the preset value
  - When the synthesized AC acceleration value (for calculation or for control) selected for the PV exceeds the preset value
  - When liquefaction is detected There are three vibration detection contact outputs, for which individual conditions can be set.
- The user can adjust the 4–20 mA analog output using the PV bias and PV low cutoff function.
- During operation, various diagnostics are conducted. If an error is found, a minor or serious failure will occur. The diagnosis results are output to the minor failure or serious failure output.
- If there is a large acceleration input that does not have seismic wave characteristics, the noise (interference) protection function of this unit will be activated. When activated, noise protection affects the vibration detection output and analog output for about 1 minute. During this time the noise protection output is ON.
- If the unit receives a digital input signal, it goes into maintenance mode, suspends the basic earthquake measurement functions, and executes DO, AO, and relay output sequence operations for accelerometer and input/output diagnosis. In the case of abnormal results from the accelerometer diagnosis, a serious failure occurs.
- The following operations can be done with the loader: changing various calculation parameters such as vibration detection output settings, collecting waveform records, monitoring the measured values, and monitoring detailed error diagnosis results.
- Data can be read and settings can be changed remotely through RS-485 communications. A DCX350 remote data collector and a dedicated display unit (with application software) can be connected.
- Using the loader, the settings can be changed to obtain functions (input/output and operation) that are basically equivalent to those of the SES60 (the old model).
- The unit casing has a pressure-resistant explosion-proof construction (Ex d IIC T4) and an IP67 seal.

## ■ Model selection

Standard model	SES70AV320-1110
With inspection report	SES70AV320-111D
Inspection report + traceability certificate	SES70AV320-111Y

# Memo

---



# Chapter 2. NAMES AND FUNCTIONS OF PARTS

## Names of parts

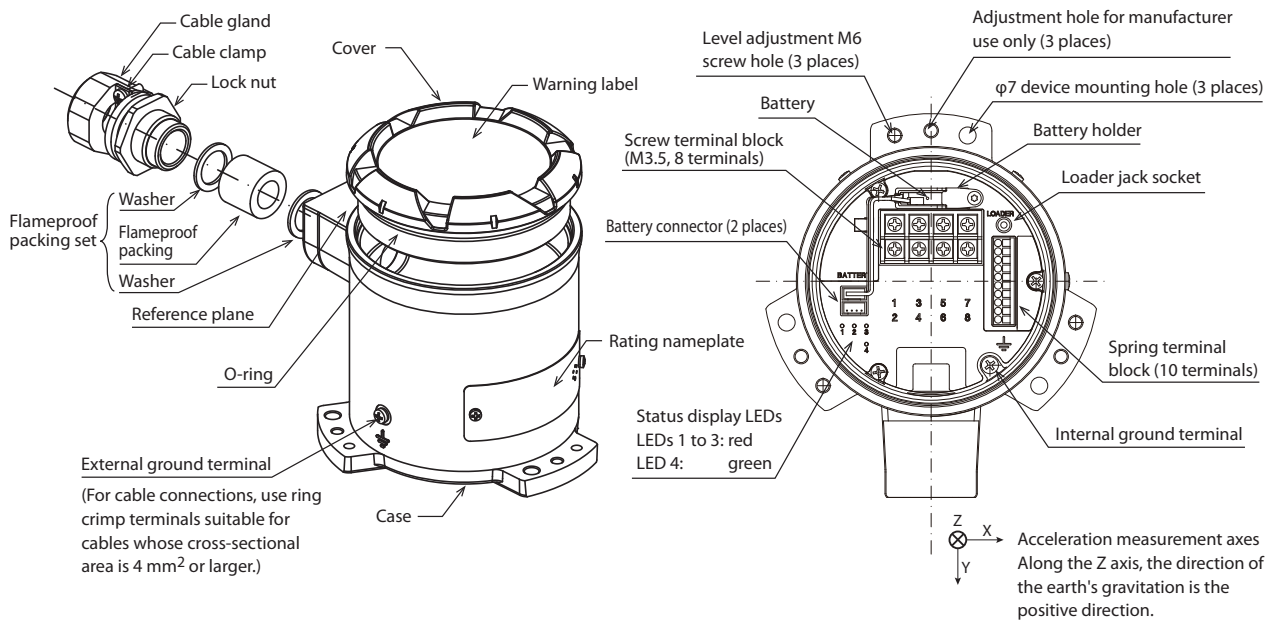

### Note

- The arrows for the acceleration measurement axes show the directions of acceleration in response to vibration. When the sensor moves in the direction indicated by an arrow, the acceleration is positive in that direction. When the sensor is tilted in the direction indicated by an arrow, the acceleration is measured as negative in that direction.

☞ ■ Measurement principles (P. 2-2)

## Basic function block diagram

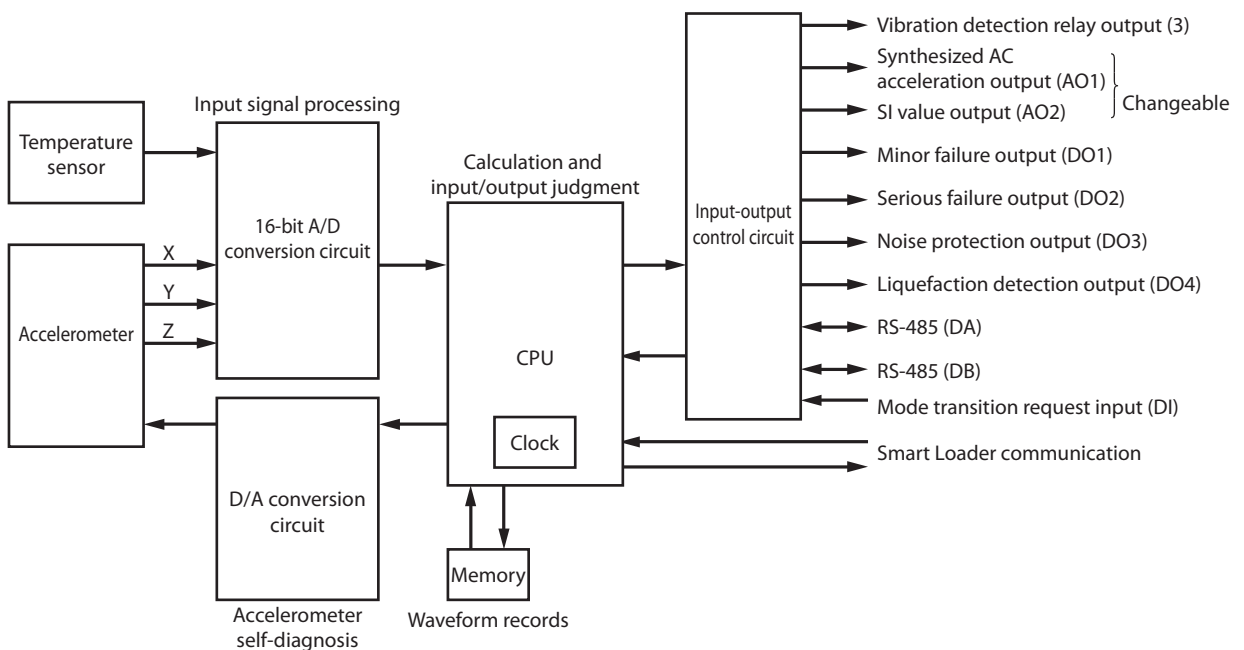

Note: The memory and the clock are backed up by the battery.

■ Internal structure

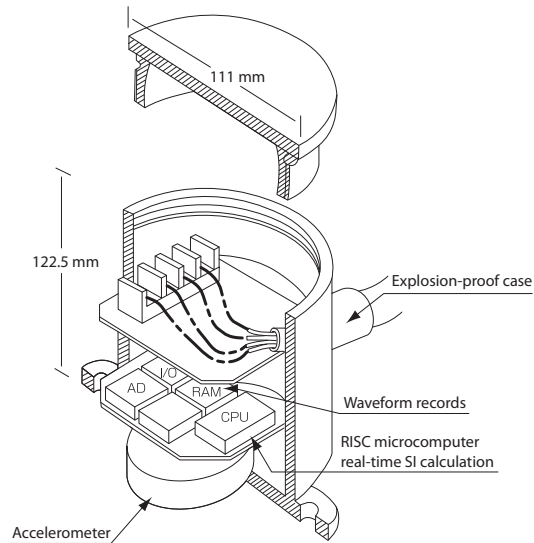

■ Measurement principles

The accelerometer uses a highly sensitive position detector to precisely detect the positional deviation of the pendulum in response to acceleration. It then sends an electrical signal (current) proportional to the positional deviation of the pendulum from the servo-amplifier to the drive circuit (drive coil + magnet) in order to return the pendulum to the reference point position.

Since the electrical signal from the servo-amplifier is proportional to the acceleration, the acceleration can be measured from the electrical signals.

In the accelerometer, the pendulum is normally located at the reference position when in the earthquake measurement state, and stress applied to the spring of the pendulum does not affect the measurement. Therefore, acceleration can be measured with high accuracy.

- P: Pendulum
- B: Spring
- C: Drive coil
- M: Magnet
- D: Position detector
- S: Servo circuit
- I: Electrical signal for measurement

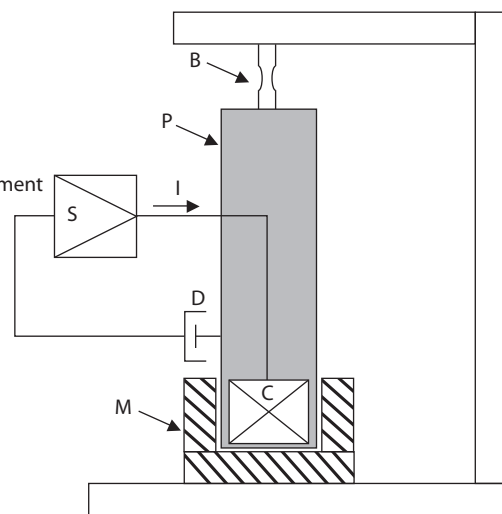



Structure of the accelerometer

! Handling Precautions



- If the unit is dropped accidentally or if a falling object, etc., strikes the unit, device failure may result. Take care when installing the unit.

# Chapter 3. INSTALLATION

## WARNING

-  For explosion-proof instrumentation, install and wire this unit in accordance with the National Institute of Industrial Safety's User's Guidelines for Electrical Installations for Explosive Gas Atmospheres in General Industry (Tokyo, 1994 [in Japanese]).
-  This unit is certified as a pressure-resistant explosion-proof construction (Ex d IIC T4). Install this unit in a location conforming to the conditions for a flameproof structure.

## CAUTION

-  During installation or maintenance work, take care not to drop the unit accidentally to prevent injury to feet, etc.
-  This unit is not protected against lightning. As necessary, take appropriate instrumentation to protect equipment from lightning.
-  Do not subject this device to shock that exceeds the operating conditions stated in the specifications. Doing so may cause device failure.

### ■ Installation Location

Avoid installing the device where it will be subject to conditions such as the following.

- Ambient temperature below  $-10^{\circ}\text{C}$  or above  $+60^{\circ}\text{C}$
- Humidity higher than 90 % RH
- Sudden temperature fluctuations causing condensation
- Corrosive or combustible gas.
- Large amounts of conductive substances (e.g., dust, salt, or iron powder) or organic solvents
- Direct shock or vibration other than earthquake motion
- Direct sunlight
- Large amounts of water or rain
- Splashing by fluids (e.g., oil or chemicals)
- Strong magnetic or electrical fields

### ■ Installation Instructions

This unit measures ground acceleration caused by earthquake motion in order to calculate the estimated amount of damage. Installation of this unit on a concrete foundation separated from buildings is recommended so that building vibration does not affect measurement.

In addition, where needed to prevent direct exposure to sunlight or rain, provide a protective roof or cover.

### Handling Precautions

- Do not use the three adjustment holes (which are for manufacturer use only) when installing the unit.
- When installing the unit on a concrete foundation, check that the foundation is not hollow by tapping it with a small hammer.

When installing this unit, select one of the methods shown below, depending on the installation conditions.

● **If the installation surface is level within  $\pm 3^\circ$**

- (1) Select a flat concrete surface for installation.
- (2) Put three anchors in the surface, aligned with the three 7 mm mounting holes in the unit.
- (3) Attach the unit with the three mounting screws (M5  $\times$  30 mm).

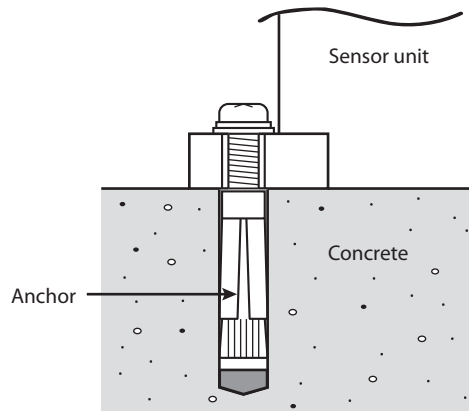

 **Note**

- Example of an anchor: PY4002 AY plug bolt

● **If the installation surface is not level**

- (1) Get a metal plate (10 mm thick or more) with three holes for level adjustment and three threaded M5 holes for attaching the unit. The dimensions of the mounting plate are shown below.

Unit: mm

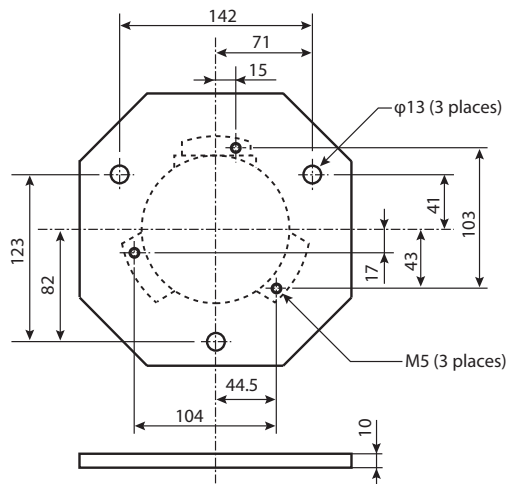

 **Handling Precautions**

- If the mounting plate is attached to a concrete surface, use M10 or larger anchors.  
The diameter of the corresponding holes in the plate is 13 mm.

- (2) Put three anchors in the concrete surface for attaching the mounting plate.
- (3) Attach the mounting plate to the anchors as shown in the figure below.

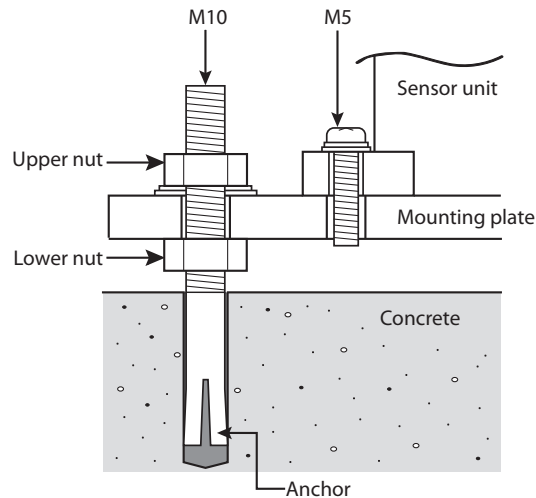

- (4) Adjust the three lower nuts so that the mounting plate is level.
- (5) Tighten the upper nuts to secure the plate.

**! Handling Precautions**

- Tighten the three upper nuts evenly so that the plate remains level.
- After the mounting plate has been installed, make sure that it is level within  $\pm 2^\circ$ .

- (6) Temporarily tighten the mounting screws (M5  $\times$  20 mm) included with the unit.
- (7) Check that the unit is level.
- (8) Make fine adjustments of the M6 hexagon socket setscrews so that the unit is level.
- (9) Tighten the three mounting screws (M5  $\times$  20 mm), which were previously tightened temporarily, to secure the unit.

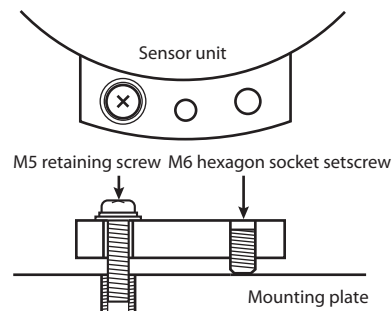

**● What to check after installation**

Place a level on the reference plane of this unit to check that the unit is level within  $\pm 3^\circ$ .









If the unit is not installed correctly, malfunction could result.

# Memo







---

# Chapter 4. WIRING

## WARNING

-  For explosion-proof instrumentation, install and wire this unit in accordance with the National Institute of Industrial Safety's "User's Guidelines for Electrical Installations for Explosive Gas Atmospheres in General Industry" (Tokyo, 1994 [in Japanese]).
-  Use cables with a heat resistance to temperatures of 80 °C or more.  
If a cable with a heat resistance of less than 80 °C is used, the unit will no longer be a certified explosion-proof product. Moreover, fire or device failure may result.
-  Always use the cable gland and flameproof packing set supplied with this unit.  
Use packing that is appropriate for the cable. If the wrong packing is used, the unit will no longer be a certified explosion-proof product.
-  Before doing wiring work, be sure to disconnect the power. Failure to do so may result in an electric shock.
-  During installation, trial runs, and maintenance work, do not touch the power terminals. There is a risk of electric shock.
-  During installation, trial runs, and maintenance work, if the unit malfunctions, immediately disconnect the power.
-  If the cover is open in a hazardous area, do not turn on the electricity.
-  When there might be an explosive atmosphere, do not open the cover.
-  If you use the Smart Loader Package (sold separately), do so in a non-hazardous area where there is no danger of explosion or fire.

## CAUTION

-  Use shielded cables for wiring.
-  Be sure to carry out the wiring work properly. Incorrect wiring may cause device failure. (Particularly, do not mistakenly connect the DO to the RS-485 terminal.)
-  The power and signal lines must be isolated from the ground. Otherwise, noise could cause malfunction or device failure.
-  Do not allow crimp terminals (etc.) to come into contact with adjacent terminals.  
Doing so may cause fire or device failure.
-  Be sure to use bootlace ferrules when wiring the spring terminal block.
-  Do not use a walkie-talkie or other transceiver within 2 m of this unit or cables connected to this unit. Doing so may cause this unit to malfunction.
-  Take care not to damage the threads on the case or cover.  
If the threads are damaged, the cover will not open and close properly.

## ■ Wiring Procedure

(1) Loosen the setscrew to open the cover.

### ! Handling Precautions

- If it is difficult to open the cover, put an appropriate tool, such as the handle of a screwdriver, in the grooves on the cover after the case has been secured, and then turn the tool in the direction indicated by the arrow to open the cover.
- If the tool slips, you may be injured. Always carry out the above work carefully.

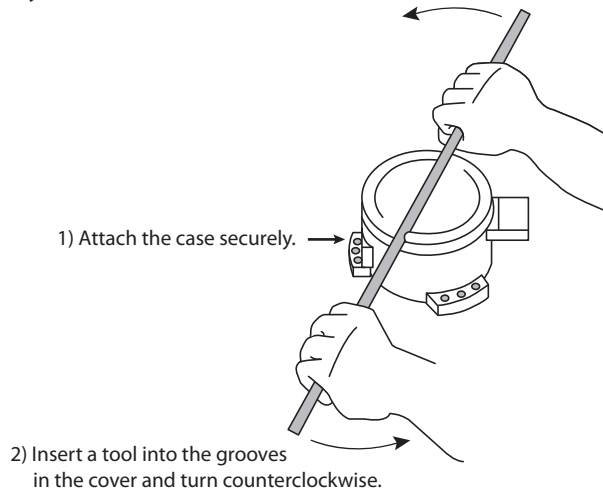

(2) The cable lead-in system of this unit uses flameproof packing. The compatible cable outer diameter is 10–14 mm. The following flameproof packing sets corresponding to cables are included with this unit. Use packing that is appropriate for the cable.

Flameproof packing set for 10–12 mm outer diameter cable

Flameproof packing set for 12–14 mm outer diameter cable

- (3) Insert the cable into the unit as shown below, and connect the cable to the terminal block.
- (4) Screw in the cable gland so that the amount of compression corresponds to the cable outer diameter as specified in the "Cable outer diameter and amount of packing compression" table below.
- (5) Tighten the lock nut.
- (6) Secure the cable using the cable clamp. (tightening torque: 0.6 N·m)
- (7) Connect the battery cable included with this unit to the battery connector and insert the battery into the battery holder. The cable can be connected to either battery connector.

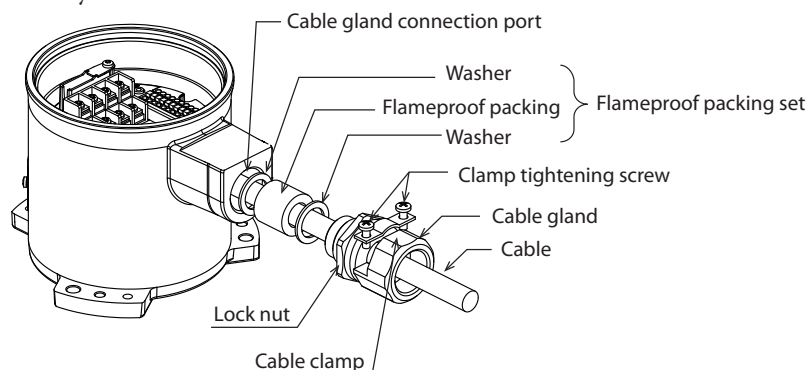



**Note**

- The table below shows the proper amount of packing compression for various cable diameters.

The appropriate amount of packing compression varies depending on the cable diameter and the packing inner diameter. Measure the outer diameter of the cable and choose the most appropriate amount of compression for the cable from the table below. The amount of compression can also be adjusted by the number of screw rotations. In the table, counting of the number of screw rotations begins when the cable gland contacts the packing.

Cable outer diameter and amount of packing compression

Cable outer diameter (mm)	Packing inner diameter (mm)	Packing compression (mm)	No. of screw rotations
φ 10.0 min.	12	3.9	2.1
φ 10.5		3.5	1.9
φ 11.0		3.1	1.7
φ 11.5		2.7	1.5
Less than φ 12.0	14	2.2	1.2
φ 12.0 min.		4.5	2.5
φ 12.5		4.0	2.2
φ 13.0		3.5	1.9
φ 13.5		2.9	1.6
φ 14.0		2.3	1.3

Packing compression (left: before, right: after)

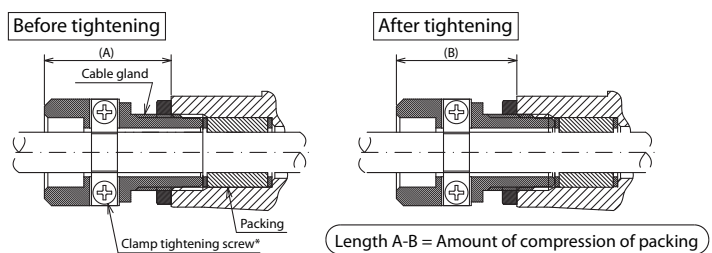

Tighten the clamp tightening screws to a maximum torque of 0.6 N·m.

● **Wiring diagram**

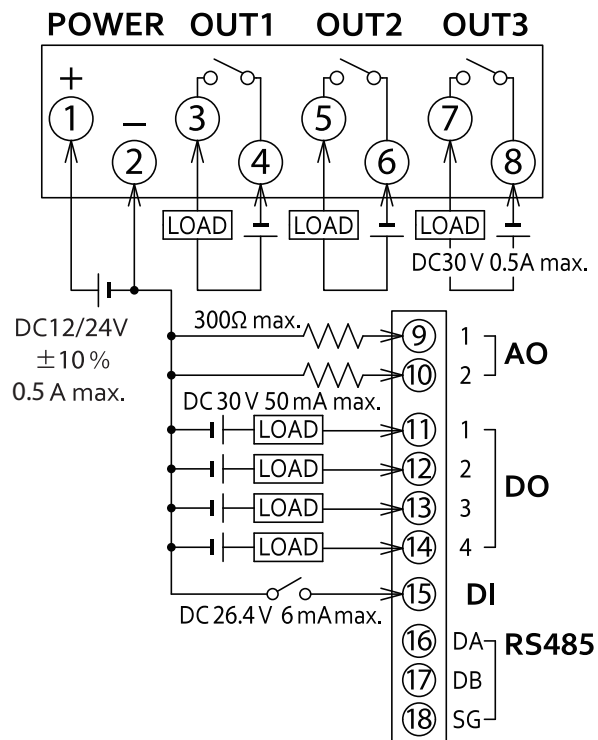

- Notes.
- Terminal SG (for RS-485) is connected to terminal ② in the terminal block inside the unit.
  - Do not connect the DO to the RS-485 terminals.

● Screw terminal block

Terminal No.	Signal
1	Power (+) (12/24 V DC)
2	Power (-) (0V DC)
3, 4	Relay contact output 1 (vibration detection output 1)
5, 6	Relay contact output 2 (vibration detection output 2)
7, 8	Relay contact output 3 (vibration detection output 3)

● Spring terminal block

Terminal No.	Signal
9	Analog output 1: 4–20 mA ([synthesized AC acceleration], SI value, JMA seismic intensity scale equivalent value)
10	Analog output 2: 4–20 mA (synthesized AC acceleration, [SI value], JMA seismic intensity scale equivalent value)
11	Digital output 1 (minor failure output*1/mode display, [positive logic], negative logic)
12	Digital output 2 (serious failure output*2, [positive logic], negative logic)
13	Digital output 3 (noise protection output, [positive logic], negative logic)
14	Digital output 4 (liquefaction detection output)
15	Digital input (transition request to maintenance mode/standby mode and diagnostic phase change request in the maintenance sequence)
16	RS-485 DA
17	RS-485 DB
18	RS-485 SG

Note: The default setting is enclosed in brackets, [ ].

\*1. A minor failure does not affect control output, but a check should be made for waveform record and clock data storage errors, as well as clock data errors. The installation conditions should also be checked. While LED 4 (green) is lit, LED 1 (red) is lit and digital output 1 (DO1) turns ON.

In any mode other than measurement mode, DO1 repeatedly turns ON and OFF. In addition, by changing the setting, it can be made to turn ON only when a minor failure occurs.

\*2. A serious failure may affect control output such as vibration detection output and liquefaction detection output. While LED 4 (green) is lit, LED 2 (red) is lit Then digital output 1 (DO1) turns ON. Note that when a serious failure occurs, minor failure output (DO1) is also generated.

## ! Handling Precautions

- For explosion-proof instrumentation, install and wire this unit in accordance with the National Institute of Industrial Safety's User's "Guidelines for Electrical Installations for Explosive Gas Atmospheres in General Industry" (Tokyo, 1994 [in Japanese]).
- Keep wiring away from cables connected to a commercial power supply or motor drive power supply that is likely to produce electrical noise.
- If this unit is used alone, its miswiring protection is effective. However, if multiple units are connected through RS-485, miswiring of the power source may cause device failure. Be sure to check that the wiring is correct before turning the power on.
- For screw terminal connections, use crimp terminals that are the correct size for M3.5 screws
- For spring screw terminal connections, use wires whose nominal cross-sectional area is 0.25–0.75 mm<sup>2</sup> (24 to 18 AWG), with bootlace ferrules. Use bootlace ferrules and a crimping tool that comply with the following standards. Do not insert stripped or soldered ends of stranded wires into the spring terminal block.  
 Bootlace ferrule: DIN 46228 sect. 4  
 Crimping tool: DIN 46228 parts 1 and 4  
 The compatible bootlace ferrules and crimping tool made by Weidmüller Japan Co., Ltd. are shown below

Compatible bootlace ferrules made by Weidmüller Japan

Connectable wire (mm <sup>2</sup> )	Stripped wire length (mm)	Part No.
0.25	10	H0.25/12
0.34		H0.34/12
0.50		H0.5/14
0.75		H0.75/14

The manufacturer's compatible crimping tool: PZ 6 Roto

- To connect a wire to the spring terminal block, insert a bootlace ferrule into the hole (push-in system).
- To remove a wire from the spring terminal block, push the button on the block using a flat-head screwdriver (tip size: 0.4 x 2.5 mm) and pull out the wire. The standard pushing force on the button and the pushed distance are 20 N and 1.7 mm respectively. If the pushing force on the button is 40 N or greater, device failure could result.
- For wiring for RS-485, do not connect an external terminating resistor.
- For wiring, follow the wiring diagram.
- Use shielded cables for wiring.  
 Use a shielded cable to wire the ground terminal inside the case.  
 Use either of the following methods so that there is only one ground connection.
  - (1) Ground the other end of the shielded cable that is connected to the ground terminal inside the case.
  - (2) Ground the ground terminal that is outside the case.

The ground connection should have a resistance of 100 Ω or less. For lightning surge protection, follow the connection sample on page 4-6.

## ■ Connecting the battery

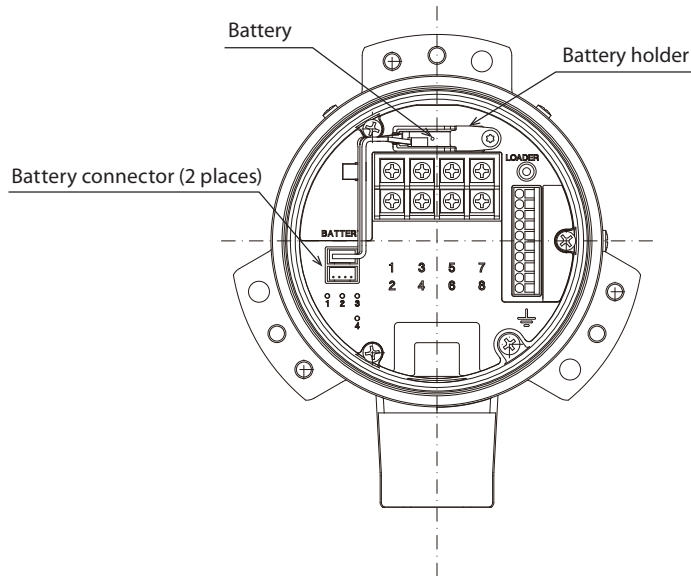

### ! Handling Precautions

- If the battery included with this unit is not used, the clock data and recorded waveform data will not be backed up while power is not being supplied. In this case, the unit will have a minor failure status.
- If the battery is not connected to the unit or if the clock is not set, the unit will have a minor failure status.
- If the removed battery is connected to the unit again, the unit may take time to recognize the battery. Until it is recognized, the unit will have a minor failure status.

## ■ Lightning surge protection

When extended signal and power lines are used, if there is a risk of power surge caused by lightning, use Azbil Corporation's FA SurgeNon surge protector (QN430C series).

Model No.	Status		Power supply
QN430C300	Signal line I	Signal line I	100 V AC
QN430C304	Signal line I	Signal line II	100 V AC
QN430C308	Signal line II	Signal line II	100 V AC

Signal line I: For power and signal lines other than RS-485 lines

(The line limit voltage is 50 V max. The line discharge start voltage is 30 V or more.)

Signal line II: For RS-485 signal lines

(The line limit voltage is 15 V max. The line discharge start voltage is 9 V or more.)

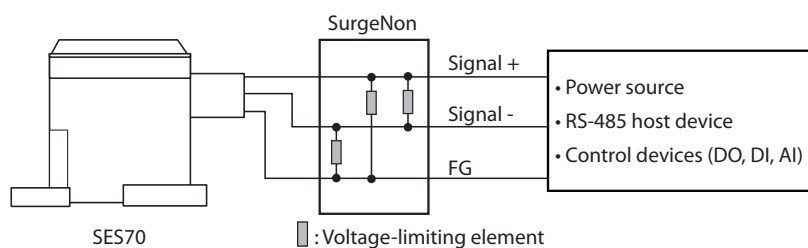

● Connection example

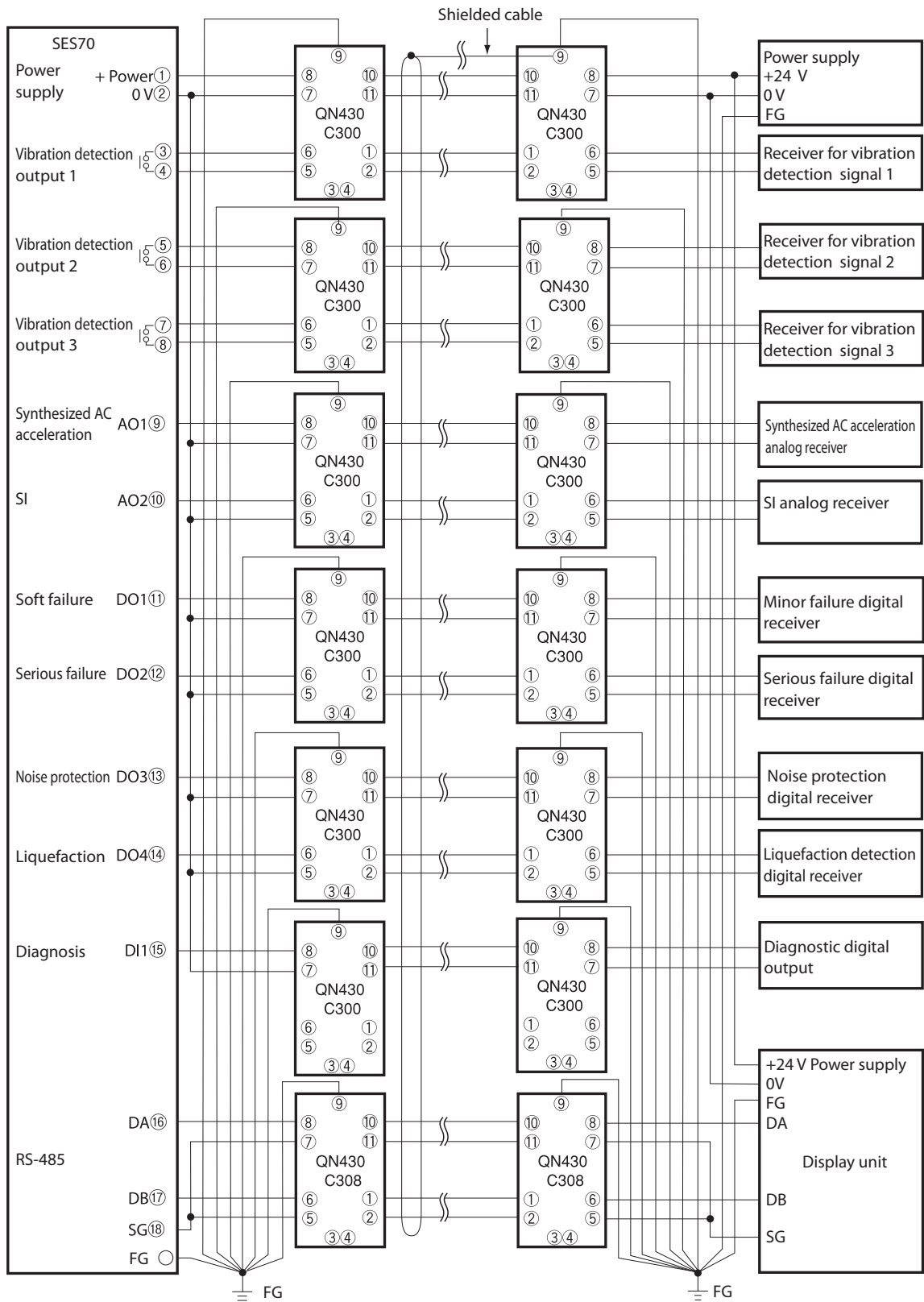

 **Handling Precautions**

- Make the wiring between the SurgeNon and the unit, power supply, receiver, etc., as short as possible.
- For wiring for RS-485, do not connect an external terminating resistor. If a terminating resistor is connected to either end of the transmission line, communication is not possible.

 **Note**

- The 100 V AC supplied to the SurgeNon (terminals (3) and (4)) is used for indication. Even if this power is not supplied, the lightning surge protective function is operative.

# Chapter 5. PREPARATIONS FOR START-UP

## WARNING



If you use the Smart Loader Package (sold separately), do so in a non-hazardous area where there is no danger of explosion or fire.

Set the time using the SLP-SE7 Smart Loader Package (sold separately).  
Here the SLP-SE7 Smart Loader Package will be referred to simply as the loader.

### ■ Procedure for setting the clock

(1) While the power to the unit is turned off, open the cover and connect the loader.

#### Handling Precautions

- If the plug is plugged into the loader jack while the power is turned on, waveforms from the impact of the connection may be recorded.

(2) Turn ON the power to this unit and wait until initialization mode changes to measurement mode (until LED 4 (green) is lit).

(3) Set the time on the unit's built-in clock using the loader. If 360 s or more pass since LED 4 lit up (since the mode changed to measurement mode), previously recorded waveforms may remain. To prevent this problem, finish setting the time so that the unit can go into standby mode within 360 s.  
After the time is set, change the mode to initialization mode using the loader.

(4) After the time is set, wait until initialization mode changes to measurement mode (wait until LED 4 is lit).

(5) Make sure that only LED 4 is lit (normal operation).

#### Handling Precautions

- If another LED (red) is blinking, an error has occurred. Check the details on the error on the detailed error screen of the loader and take corrective actions as specified in Chapter 8, MAINTENANCE AND TROUBLESHOOTING, of this manual.
- If 360 s or more pass after LED 4 lights up, previously recorded waveforms may remain. Complete the check within 360 s.

(6) Make sure that the unit is working properly, and then turn off the power and disconnect the loader.

#### Handling Precautions

- If the loader plug is removed from the jack while the power is ON, waveforms caused by the motion may be recorded.

(7) Firmly tighten the cover until its flange tightly contacts the top edge of the case.

(8) Turn on the power. After approximately 60 s have elapsed, Initialization mode changes to measurement mode, and the unit is then ready for earthquake measurement.

 SLP-SE7 Smart Loader Package for SES70 Intelligent Earthquake Sensor, No. CP-UM-5756E

 **Note**

- Before putting the unit into actual operation for the first time, clear the waveforms using the loader before turning OFF the power in step (6) so that the waveforms recorded during setup work are deleted. The waveforms recorded during work can be cleared completely.

 Chapter 6. INTERNAL PROCESSING

 **Handling Precautions**

- If the time has not been set, the clock will start at 00:00 on January 1, 2050, and the unit will have a minor failure status.
- When tightening the cover, take care to prevent cables from being caught.

 **Note**

- If the earthquake sensor is shaken manually to check the calculations of synthesized AC acceleration value, SI value, JMA seismic intensity scale equivalent value, and vibration detection judgment value of the earthquake sensor, carefully observe the following cautions:
  - (1) Check the operation after the unit has entered measurement mode. The correct output cannot be obtained in initialization mode. Additionally, any acceleration that is applied to the unit in initialization mode is judged as an error and the mode may not change to measurement mode.
  - (2) When applying any acceleration to the unit, do not tilt the earthquake sensor and be sure to shake it evenly in both the positive and negative directions. Additionally, do not stop manual shaking suddenly. Reduce the amplitude gradually.
    - If the earthquake sensor is tilted, it will enter the noise detection function's zero-cross noise detection state and a value smaller than the actual value may be output.  
 6 - 5 Noise Protection Function (P. 6-24)
    - If the earthquake sensor is shaken unevenly in the positive and negative directions, it will enter the noise detection function's ratio noise detection state, and a value smaller than the actual value may be output.
    - If manual shaking is stopped suddenly, the input acceleration in one direction will be large. Therefore, the sensor will enter the noise detection function's ratio noise detection, possibly preventing the correct value from being output.



# Chapter 6. INTERNAL PROCESSING

## 6 - 1 Modes

### ■ Mode transition

After the earthquake sensor is turned on, it operates according to the mode transitions shown below. There are four modes, which change depending on the specific operation or conditions.

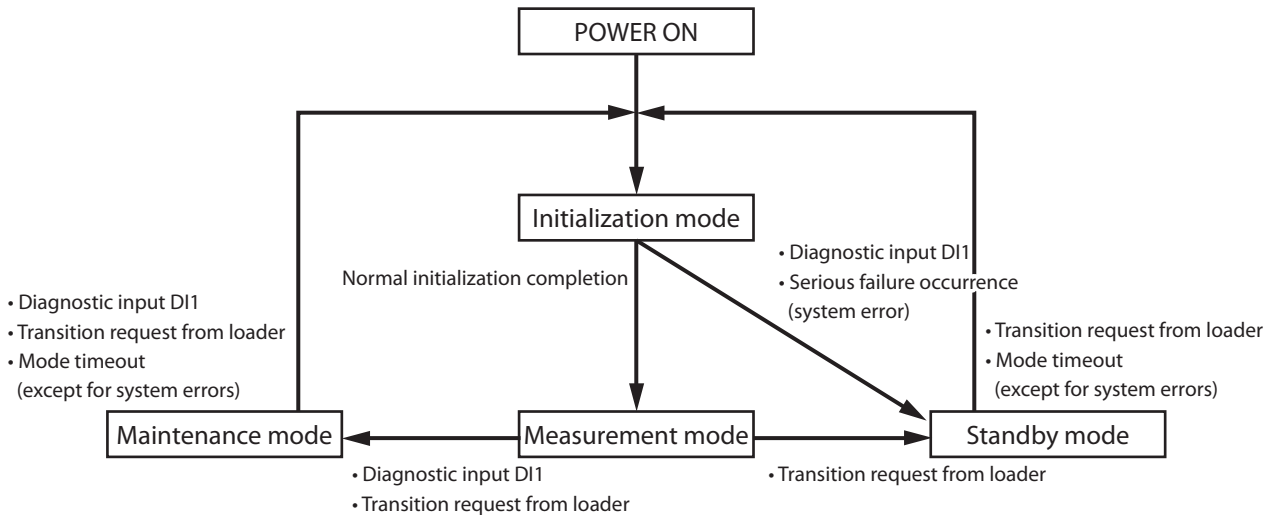

### ! Handling Precautions

- Note that when the power is turned on or off, if the power slowly rises or drops, the analog output may fluctuate.

■ **Functions of the modes**

The available functions vary depending on which of the four modes below is active.

- Initialization mode
- Measurement mode
- Standby mode
- Maintenance mode

● **Initialization mode**

In this mode the hardware is checked and system control information and numerical processing values are initialized. The unit then waits until its operation stabilizes. If the result of the hardware check is normal, the mode changes to measurement mode. If a serious failure occurs in this mode, it is judged to be a system error and the mode changes to standby mode. Also, if the DI1 diagnosis input is kept ON for 2 s or longer in initialization mode after the power has been turned ON, the mode changes to standby mode.

Status of functions in initialization mode

Function	Status
Initialization for internal calculations (acceleration, SI, synthesized AC acceleration, JMA seismic intensity scale equivalent value calculations)	●
Internal calculations (acceleration, SI value, synthesized AC acceleration, JMA seismic intensity scale equivalent value calculations)	---
Noise detection	---
Vibration detection judgment and output	---
AO output (SI value, synthesized AC acceleration, JMA seismic intensity scale equivalent value)	---
Liquefaction judgment and output	---
Automatic waveform recording	---
Forced waveform recording	---
Waveform readout	●
Waveform deletion	●
Maintenance mode sequence operation	---
Initialization mode error diagnosis and output	●
Measurement and standby mode error diagnosis and output	---
Maintenance mode error diagnosis and output	---
Manual output	---
LED indication	●
Communications data readout	●
Communications data writing	---
Sensor internal clock setup	●

● : Available    ---: Not available

### ● Measurement mode

The mode changes to measurement mode if no serious failures are detected and if initialization mode operations are completed correctly. In measurement mode, the various operations and judgment processes that are the basic processing of an earthquake sensor are executed. The AO output, vibration detection judgment output function, and liquefaction judgment output function are executed based on the SI value, synthesized AC acceleration, and JMA seismic intensity scale equivalent value. Additionally, automatic waveform recording is executed.

Status of functions in measurement mode

Function	Status
Initialization for internal calculations (acceleration, SI, synthesized AC acceleration, JMA seismic intensity scale equivalent value calculations)	---
Internal calculations (acceleration, SI value, synthesized AC acceleration, JMA seismic intensity scale equivalent value calculations)	●
Noise detection	●
Vibration detection judgment and output	●
AO output (SI value, synthesized AC acceleration, JMA seismic intensity scale equivalent value)	●
Liquefaction judgment and output	●
Automatic waveform recording	●
Forced waveform recording	---
Waveform readout	●
Waveform deletion	●
Maintenance mode sequence operation	---
Initialization mode error diagnosis and output	---
Measurement and standby mode error diagnosis and output	●
Maintenance mode error diagnosis and output	---
Manual output	---
LED indication	●
Communications data readout	●
Communications data writing	---
Sensor internal clock setup	●

● : Available    ---: Not available

● **Standby mode**

The mode changes to standby mode if any of the following occurs:

- In measurement mode, a mode transition command is received via communications.
- In initialization mode, a system error occurs when a serious failure is detected.
- After the power has been turned ON in initialization mode, the DI1 diagnosis input is kept ON for 2 s or more.

The calculation and judgment processes function in the same manner as in measurement mode. It is also possible to change various settings and to manually set various outputs using the loader.

Automatic waveform recording is not available, but forced waveform recording can be executed using the loader.

If the mode changes to standby under conditions other than a system error, it will automatically change to initialization mode due to time-out if 20 minutes have passed since the mode transition and there has been no communication.

Status of functions in standby mode

Function	Status
Initialization for internal calculations (acceleration, SI, synthesized AC acceleration, JMA seismic intensity scale equivalent value calculations)	--
Internal calculations (acceleration, SI value, synthesized AC acceleration, JMA seismic intensity scale equivalent value calculations)	●
Noise detection	●
Vibration detection judgment and output	●
AO output (SI value, synthesized AC acceleration, JMA seismic intensity scale equivalent value)	●
Liquefaction judgment and output	●
Automatic waveform recording	--
Forced waveform recording	●
Waveform readout	●
Waveform deletion	●
Maintenance mode sequence operation	--
Initialization mode error diagnosis and output	--
Measurement and standby mode error diagnosis and output	●
Maintenance mode error diagnosis and output	--
Manual output	●
LED indication	●
Communications data readout	●
Communications data writing	●
Sensor internal clock setup	●

●: Available    --: Not available

### ● Maintenance mode

The mode changes to maintenance mode if a mode change command is received in measurement mode via communications or if the DI1 diagnosis input is kept ON for 2 s or longer. An operational check of the earthquake sensor input, output, and accelerometer is conducted as phases 1–3 of the maintenance sequence. In this mode, internal calculation equation and output judgment functions do not operate. After the operational check in each phase, if there is a command via communications or if the DI1 diagnosis input is kept ON for 2 s or longer, an operational check is done for the next phase.

After the maintenance sequence has been completed, if there is a command via communications or if the DI1 diagnosis input is kept ON for 2 s or longer, the mode changes to initialization mode. Also, if 20 minutes have passed since the mode changed to maintenance mode, it will automatically change to initialization mode due to time-out.

Status of functions in maintenance mode

Function	Status
Initialization for internal calculations (acceleration, SI value, synthesized AC acceleration, JMA seismic intensity scale equivalent value calculations)	--
Internal calculations (acceleration, SI value, synthesized AC acceleration, JMA seismic intensity scale equivalent value calculations)	--
Noise detection	--
Vibration detection judgment and output	--
AO output (SI value, synthesized AC acceleration, JMA seismic intensity scale equivalent value)	--
Liquefaction judgment and output	--
Automatic waveform recording	--
Forced waveform recording	--
Waveform readout	●
Waveform deletion	●
Maintenance mode sequence operation	●
Initialization mode error diagnosis and output	--
Measurement and standby mode error diagnosis and output	--
Maintenance mode error diagnosis and output	●
Manual output	--
LED indication	●
Communications data readout	●
Communications data writing	--
Sensor internal clock setup	●

●: Available    --: Not available

● Status of functions in all modes

- Initialization mode
- Measurement mode
- Standby mode
- Maintenance mode

Status of functions in all modes

Function	Initialize	Measurement	Standby	Maintenance
Initialization for internal calculation (acceleration, SI value , synthesized AC acceleration, JMA seismic intensity scale equivalent value calculations)	●	--	--	--
Internal calculations (acceleration, SI value, synthesized AC acceleration calculations, JMA seismic intensity scale equivalent value calculations)	--	●	●	--
Noise detection	--	●	●	--
Vibration detection judgment and output	--	●	●	--
AO output (SI value, synthesized AC acceleration, JMA seismic intensity scale equivalent value)	--	●	●	--
Liquefaction judgment and output	--	●	●	--
Automatic waveform recording	--	●	--	--
Forced waveform recording	--	--	●	--
Waveform readout	●	●	●	●
Waveform deletion	●	●	●	●
Maintenance mode sequence operation	--	--	--	●
Initialization mode error diagnosis and output	●	--	--	--
Measurement and standby mode error diagnosis and output	--	●	●	--
Maintenance mode error diagnosis and output	--	--	--	●
Manual output	--	--	●	--
LED indication	●	●	●	●
Communications data readout	●	●	●	●
Communications data writing	--	--	●	--
Sensor internal clock setup	●	●	●	●

●: Available    --: Not available

## 6 - 2 Internal Calculation Processes

### Internal Calculation

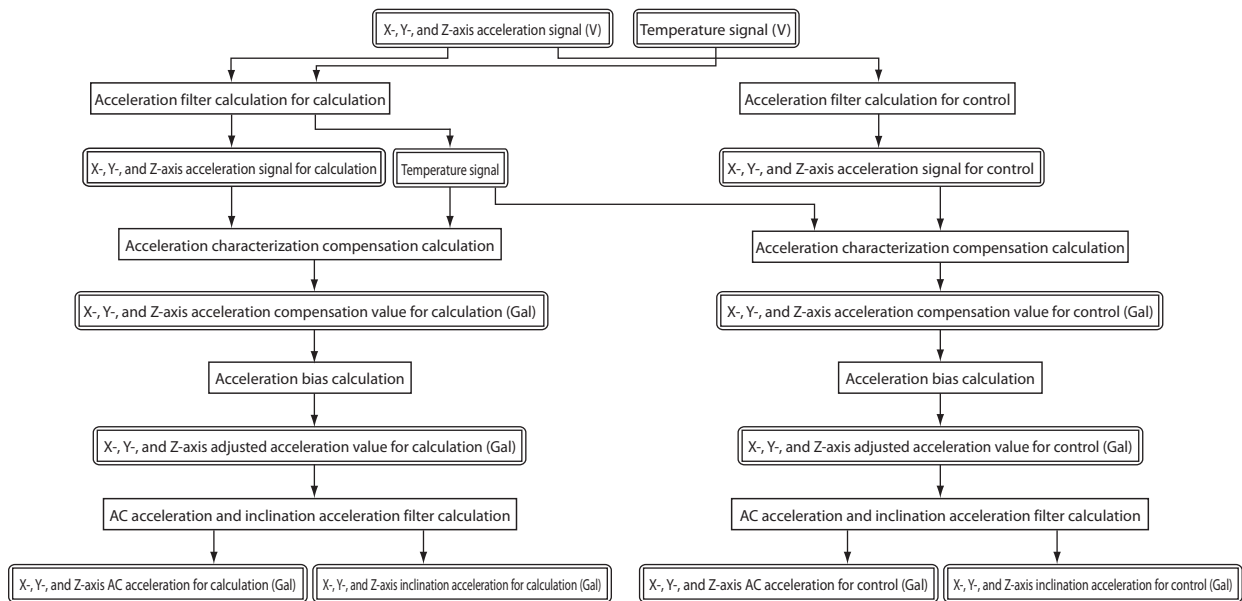

Flowchart of acceleration signal processing

#### ● Acceleration filter calculation

The output from the accelerometer is passed through two low-pass filters set for different cutoff frequencies that are useful for different applications in order to obtain two acceleration values. These are acceleration for calculation of frequency characteristics, for calculating an index, and acceleration for control of frequency characteristics, for noise reduction by taking the AO and relay output into consideration. The low-pass filter can be changed by setting the acceleration filter value in the loader. Initial value: 30 Hz for calculation, 10 Hz for control

#### ● Acceleration characterization calculation (acceleration compensation value)

This calculation compensates for an output error of an individual accelerometer. The acceleration compensation value includes compensation for the accelerometer's sensitivity and zero-point, and for the temperature.

#### ● Acceleration bias calculation (adjusted acceleration value)

Using the auto bias function of the loader, the acceleration compensation value bias is adjusted according to the installation conditions in order to calculate the adjusted acceleration value.

The adjustment is made so that the adjusted acceleration value is near 0 Gal under the current installation conditions.

Waveforms are recorded using adjusted acceleration values for calculation.

#### ! Handling Precautions

- Acceleration is always detected in a range of  $\pm$  several gals due to the specifications of the acceleration detection element. Therefore, the adjusted acceleration value does not exactly equal 0 Gal.

#### ● AC acceleration and inclination acceleration filter calculations (AC acceleration and inclination acceleration)

The inclination acceleration is calculated by passing the adjusted acceleration value through a low-pass filter (0.05 Hz). Inclination acceleration is the static acceleration due to temperature or inclination.

AC acceleration is the result of subtracting the inclination acceleration from the adjusted acceleration.

AC acceleration is the amount of dynamic acceleration.

$$\text{AC acceleration} = \text{adjusted acceleration} - \text{inclination acceleration}$$

### ■ Various calculations and judgment processes

This section gives an overview of the calculation processes. Each calculation is executed at intervals of 10 ms.

☞ 6 - 7 Output Functions (P.6-29)

▭ shows calculations and judgment processes.  
 ▭ shows the resulting values.

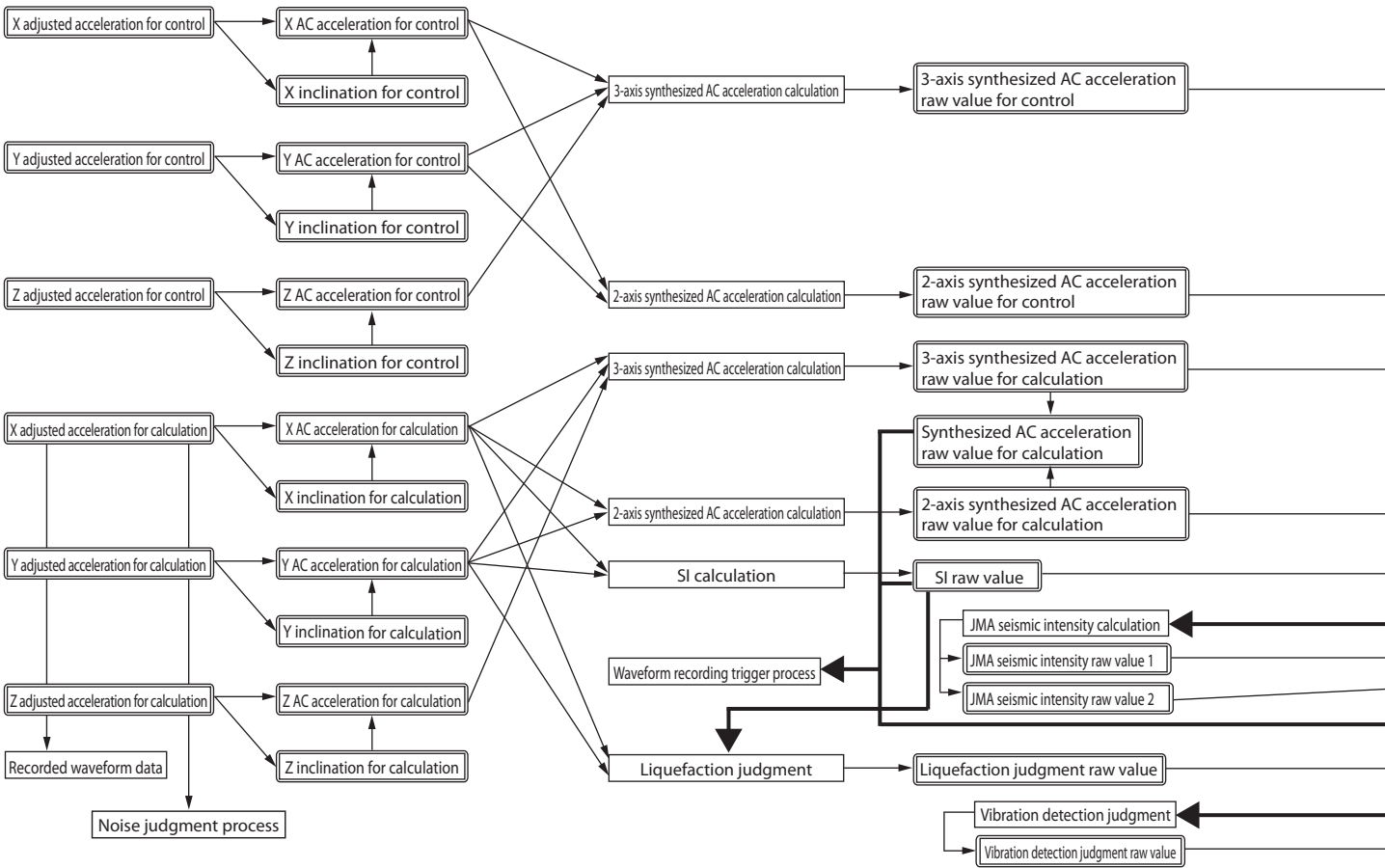

Flowchart of various calculation and judgment processes



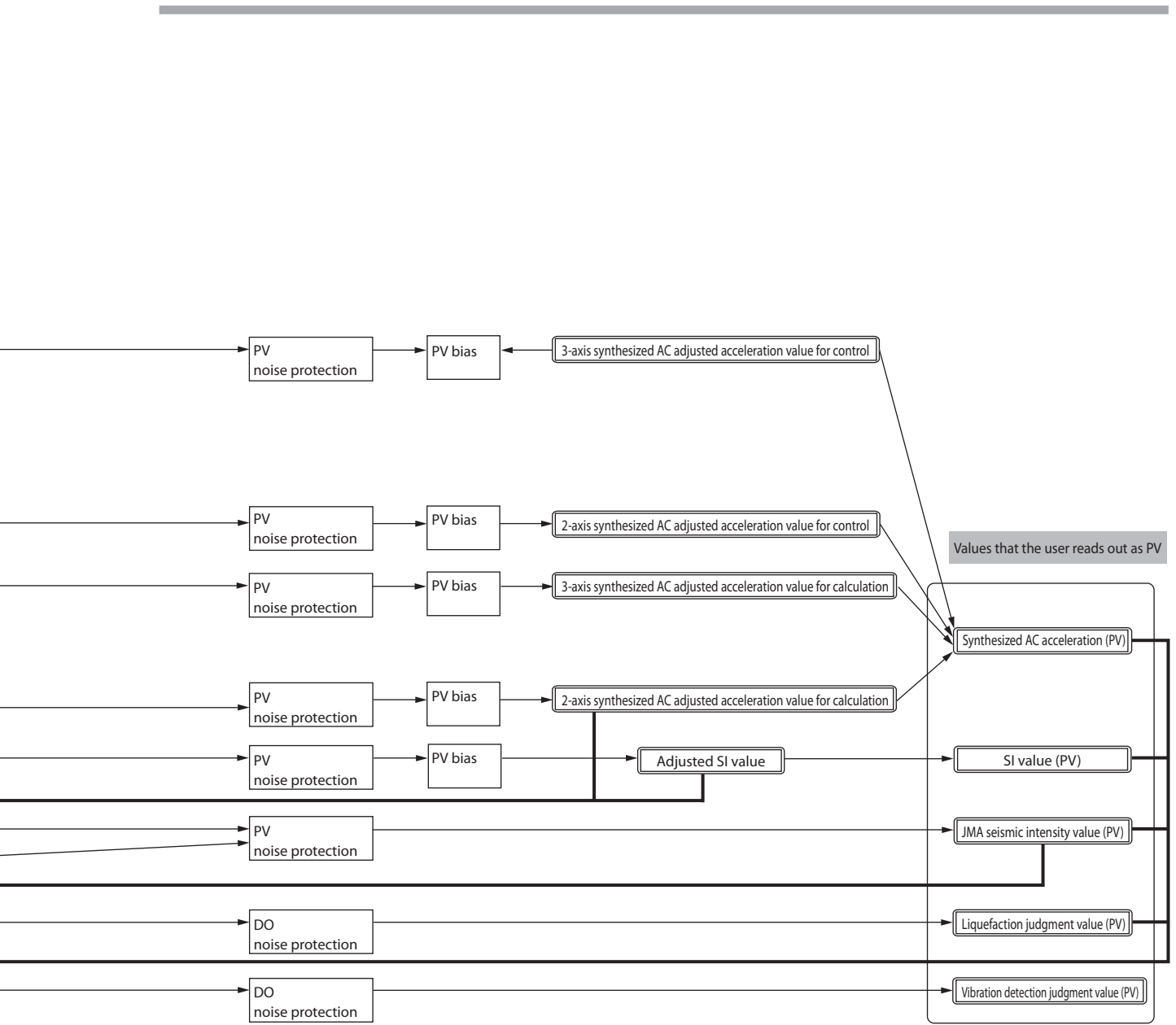

■ SI calculation

The SI value indicates how much destructive power is applied to virtual structures (such as buildings), which are created by equations, based on the actual vibration detected by the sensor on the ground. Therefore, this value serves as an index for the amount of damage to actual structures. As shown below by actual earthquake damage data in "Relationship between SI value and maximum acceleration," there may be only minor damage from an earthquake with large acceleration, but there is major damage if the earthquake has an SI value of approximately 30 kine or more. Therefore earthquake damage is correlated more with SI value than with acceleration.

The virtual structure used for the SI calculation consists simply of a weight, spring, and damper having only one direction of motion and one natural period, which form a system with 1 degree of freedom and 1 mass.

For structures with a major natural period between 0.1 and to 2.5 s, as shown below in "Example of Sv calculation by natural period," a calculation is done for each of seven natural periods. In these calculations, the shaking of the earth (acceleration) detected by the accelerometer is used as input from which the speed response is calculated. The largest of the speed responses is the Sv.

Since the SES70 executes the calculations in real time, the Sv value is obtained from the speed responses for the past 10 to 20 s. As the speed responses become smaller over time, the Sv value also becomes smaller.

To calculate the SI value, linear interpolation is applied to the result of calculation for each natural period as shown in "Example of Sv calculation by natural period," in order to calculate the average of the Sv values for 0.1 to 2.5 s.

Also, the SI value calculated from the earthquake waveform has a directional dependency, as shown in the figure, "Example of SI calculation in eight directions." Therefore, the speed responses and Sv value on the horizontal plane in eight directions are determined in order to calculate the SI for each of the eight directions. The SI that is finally output is the largest of the values in the eight directions.

The SI value calculated by the SES70 on the basis of the seven natural periods and vector projection in 8 directions is called SI #1. An SI value calculated on the basis of 24 natural periods and 16 directions, which is called SI #2, can also be selected.

● SI equation

[SI equation]

$$SI = \frac{1}{2.4} \int_{0.1}^{2.5} Sv dT (h=0.2)$$

Sv: Speed response spectrum  
 T: Period  
 h: Damping constant

● Relationship between SI value and maximum acceleration

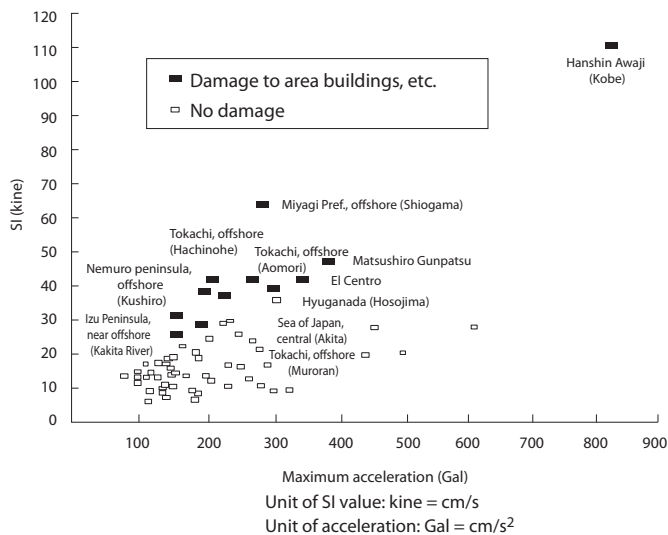

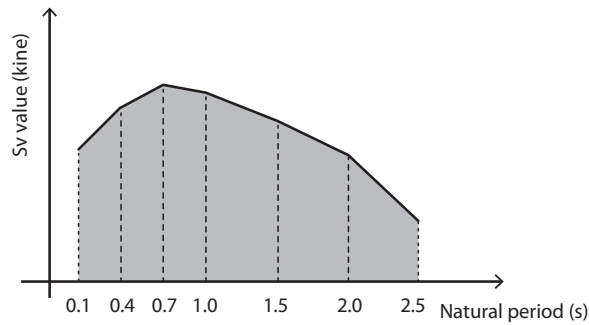

Example of Sv calculation by natural period

The SI value is the average of the speed response spectrum (Sv) for a period (T) of 0.1 to 2.5 s. As shown in the figure on the left, the SES70 uses a polygon to approximate the speed response spectrum (Sv) of each of the seven natural periods in order to obtain a highly accurate SI calculation. Note: SI calculation on the basis of 24 natural periods can also be selected.

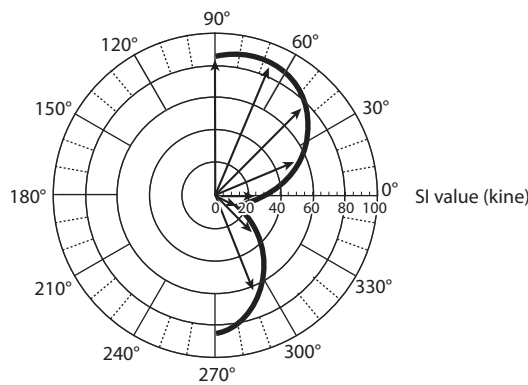

Example of SI calculation in eight directions

Since the SI value varies depending on the direction from which the seismic waves come, calculations in multiple directions are necessary. As shown in the figure on the left, the SES70 calculates SI values in eight directions and uses the greatest of these values to obtain high accuracy in the SI calculation. Note: SI calculation in 16 directions can also be selected.

### ■ Synthesized AC acceleration calculation

According to the 3-axis (X-, Y-, and Z-axis) AC acceleration value for calculation and AC acceleration value for control that are detected by the accelerometer, vectors of two axes on the horizontal plane or of three axes (selectable) are synthesized to find the maximum value.

The maximum value is taken from the synthesized acceleration values that were obtained until 10 to 20 s before the current time.

Therefore, the maximum value is retained for the above length of time and then is updated.

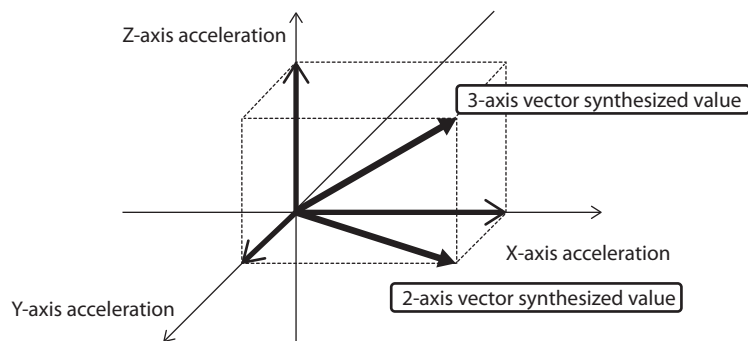

Synthesized AC acceleration calculation

### ■ Calculation of the JMA seismic intensity scale equivalent value

Calculation of the seismic intensity ( $I_{JMA}$  or JMA seismic intensity) that is equivalent to the measured vibration can be based on either of two correlation equations formulated by Prof. Yamazaki of the Earthquake Research Institute of the University of Tokyo. The equations use the adjusted SI value (SI) alone or that value with the 2-axis synthesized AC adjusted acceleration value for calculation (PGA). The desired equation can be selected using the loader. Default: Equation 1.

Equation 1:  $I_{JMA} = 1.74 + 1.38 \times \log_{10} (SI) + 0.59 \times \log_{10} (PGA)$

Equation 2:  $I_{JMA} = 2.39 + 1.92 \times \log_{10} (SI)$

Note: The correlation between these equations and values from 2.0 to 7.9 on the JMA seismic intensity scale has been confirmed. The correlation of values under 2.0 is not reliable.

### ■ Relationship of the JMA scale (shindo scale), acceleration, SI value, and measured seismic intensity (shindo)

Old Japanese seismic intensity scale		New Japanese seismic intensity scale			Applicability of JMA scale equivalence
Seismic intensity (shindo)	Acceleration (Gal)	Seismic intensity (shindo)	Measured seismic intensity (shindo)	SI value (kine)	
0	Less than 0.8	0	Less than 0.5	-	---
1	0.8 to less than 2.5	1	0.5 to less than 1.5	-	---
2	2.5 to less than 8.0	2	1.5 to less than 2.5	-	▲
3	8.0 to less than 25.0	3	2.5 to less than 3.5	1.1 to less than 3.8	●
4	25.0 to less than 80.0	4	3.5 to less than 4.5	3.8 to less than 12.6	●
5	80.0 to less than 250.0	5-	4.5 to less than 5.0	12.6 to less than 22.9	●
		5+	5.0 to less than 5.5	22.9 to less than 41.7	●
6	250.0 to less than 400.0	6-	5.5 to less than 6.0	41.7 to less than 75.9	●
		6+	6.0 to less than 6.5	75.9 to less than 138.2	●
7	400.0 or more	7	6.5 or more	138.2 or more	●

●: Applicable

▲: Depending on the waveform, there may be a large error.

---: Not applicable due to a large amount of error

The JMA seismic intensity scale equivalent value is the same as the measured seismic intensity.

The JMA seismic intensity scale equivalent value is calculated using equation 2.

### ! Handling Precautions

- The above correspondences between JMA seismic intensity (shindo) and acceleration can be used for rough estimation. Note particularly that, since the high-frequency component of acceleration has little effect on the actual damage, if that component of the acceleration waveforms is large, the error will be large.

### ■ Noise protection process

For the SI value, synthesized AC acceleration for calculation, JMA seismic intensity scale equivalent value, and the vibration detection judgment and liquefaction judgment raw values, the results of the noise detection process is the PV value.

For any of these numeric values, if noise is detected the output is fixed at 0.

For any of raw values of these judgment results, if noise is detected, the raw value remains OFF.

☞ 6 - 5 Noise Protection Function (P. 6-24)

## 6 - 3      **Waveform Recording**

In waveform recording, the adjusted acceleration values for 3-axis calculations, the data of which is sampled at intervals of 10 ms, are recorded for 360 s if the conditions for recording are satisfied. Data including the date and time, SI value, synthesized AC acceleration value for calculation, and JMA seismic intensity scale equivalent value is recorded as the header information for each waveform recording.

The waveform recording and waveform header information can be read or deleted using the loader. The waveform recording and waveform header information are saved to RAM backed up by the battery.

Automatic waveform recording (of 10 waveforms) can be done in measurement mode, and forced waveform recording (of 1 waveform) can be done in standby mode.

### ■ **Waveform recording header information**

The following header information is attached to each waveform recording:

Trigger time (year, month, day, hour, minute, second)

Waveform valid and invalid judgments

Maximum synthesized acceleration value for calculation from the trigger point to the waveform end time

Maximum SI value [SI #1 or SI #2] from the trigger point to the waveform end time

Maximum JMA seismic intensity scale equivalent value from the trigger point to the waveform end time

Whether or not there was any serious failure, minor failure, or noise from the trigger point to the waveform end time

Whether or not any liquefaction occurred from the trigger point to the waveform end time

Whether or not there is any vibration detection output for the time between the trigger point and the waveform end time

Inclined acceleration [X-, Y-, and Z-axis] from the trigger point to the waveform end time

Sv values [Sv1–Sv7] from the trigger point to the waveform end time

Checksum value for the waveform data [360 s, 120 s]

Regarding the seven Sv values in the waveform recording header, if SI #2 is chosen as the SI value, they can be selected from among 24 Sv values by using the loader.

### ■ **Automatic waveform recording**

The basis for starting automatic waveform recording can be selected from among maximum value without trigger update, maximum value with trigger update, or threshold value.

The trigger can be selected from among SI value (raw value), synthesized acceleration for calculation (raw value), and JMA seismic intensity scale equivalent value (PV).

When recording based on maximum value (with or without trigger update) is selected, priority for storage is given to the waveforms with the largest trigger value. The ten waveforms with the largest trigger values from the start of waveform recording are retained. If two waveforms have the same trigger value, the newer waveform is retained. When recording based on a threshold is selected, any waveform whose trigger equals or exceeds the preset threshold is recorded, and the oldest waveform is deleted.

In maximum value recording without trigger update, after the trigger conditions are satisfied and recording begins, if the waveform later becomes larger, the trigger is not updated and the recording start point is not changed. On the other hand, in maximum value recording with trigger update, after the trigger conditions are satisfied and recording begins, if the waveform becomes larger, the trigger is reset to the largest point in the waveform and the start point of the recording is changed.

In the maximum value recording without trigger update, recording always starts at the head of the waveform, and therefore if the waveform is long, the part of it with the largest value may not be recorded.

In maximum value recording with trigger update, the part of the waveform with the largest value is always recorded, except perhaps if the waveform exceeds 360 seconds in length. Default settings: threshold, SI value (raw value) trigger (condition for trigger: 1 kine)

**! Handling Precautions**

- As shown below, the default settings for the SES70 are different from those for the older SES50/51/55/60 models. Be careful when using the unit without changing the default settings.

Note: The reason for making threshold value recording the default on the SES70 is that the latest earthquake or tremors will be recorded, and for checking the stability of the installation. To have the SES70 record large vibrations, change the recording method to maximum value (Max. Wave).

Default settings for waveform recording (compared with old models)

	SES70	SES50/51/55/60 (old models)
Waveform recording	Threshold value	Maximum value with trigger update
Maximum value (with trigger update) trigger type	SI value	SI value
Maximum value (without trigger update) trigger type	SI value	— (no such function)
Threshold value trigger type	SI value	SI value
Threshold value: SI amount	1 kine	30 kine
Threshold value: synthesized acceleration amount	5 Gal	300 Gal
Threshold value: JMA intensity amount	1.0	5.3

The waveform data uses 11 memory pages, P0 to P10. One of these is used as working memory to record or update the current acceleration waveform data. The ten waveform data pages (but not the working page memory) can be read using the loader. If the waveform in the working page memory (the current waveform) satisfies the trigger conditions and 360 s of acceleration data is saved, the contents of the working page are moved to another page, and the current waveform data and header information are then saved.

**! Handling Precautions**

- If the cover of this unit is opened and closed or the loader cable is connected while in measurement mode, the acceleration waveforms generated by these actions may be recorded, and therefore waveforms that were previously measured and recorded may be deleted. Always turn OFF the power to this device during work, including work near the installation location that may cause vibration or impact.

## ■ Example of maximum value recording without trigger update

In the explanatory diagram below for maximum value recording, chronological changes in acceleration and SI value are shown to illustrate the methods of acceleration waveform recording when an earthquake occurs. Chronological changes in waveform header information are also shown in the waveform header information table (☞ P. 6-16).

Note that, even though the date is recorded in the actual waveform header information, it is omitted from the explanation because all the data has the same date. The rank column in the header information table shows the priority used for saving of records in the earthquake sensor based on the trigger time in the header information. Data with rank 1 has the highest priority for saving, while rank 10 data will be the first to be deleted. Assuming that the current time is  $T$ , for purposes of illustration, the automatic waveform recording mechanism is explained along with the time flow ( $t_1$  to  $t_5$ ) shown in the figure and table.

The trigger condition for the following examples is the SI value.

- (1)  $T \leq t_1$  (16:04:55) or  $T < t_2$  (16:05:00):

The current acceleration data record is updated, with P4 as the work page. The trigger conditions are not satisfied.

- (2)  $T = t_2$  (16:05:00):

Since the SI exceeds the SI of the header item P0 (0.1 kine), which has a rank of 10, and has reached 0.2 kine, the trigger conditions for recording are satisfied. Later, if the SI exceeds 0.2 kine, the  $t_2$  trigger will not be updated. The waveform data for 30 s before  $t_2$  and the acceleration data for 330 s after  $t_2$  are saved. Other operations wait for completion of 360 s of waveform recording. Header information and work record area are not changed until the recording of waveform data for 360 s is completed.

- (3)  $T = t_3$ :

After completion of 360 s of waveform data recording at  $t_3$ , the work record area changes to P0 and P4 is retained as recorded waveform data.

Since, as the header information shows, the newly recorded P4 has the 5th largest SI, its rank becomes 5 and the rank of each of the former 5th and following waveforms is lowered by one.

- (6)  $t_3 \leq T < t_4$  (16:08:55):

Since the largest SI value in the waveform data in P0, which has now become the work page, is at time  $t_3$ ,  $t_3$  becomes the trigger point. Also, since the waveform data before  $t_3$  has already been recorded in P4, the 360 s of waveform data recording starts after trigger point  $t_3$ .

- (7)  $T = t_4$ :

Since waveform recording for 360 s has been completed at  $t_4$ , the work record area changes to P3 and P0 is retained as record data. The header information is also updated. The rank of P0 then becomes 6.

By means of sequences such as these, the waveform data from  $t_1$  to  $t_4$  is recorded onto two pages, P4 and P0. In this case, however, due to the effect of the acceleration of the previously recorded P4, the waveform of the later recorded P0 is not the 26.0 kine SI value waveform shown in the P0 header, but is rather a waveform with small acceleration. As a result, values calculated from the recorded waveform will not match the value in the header information. Therefore, when analyzing automatically recorded waveform data, it is necessary to check the trigger time in the header information to see whether there are consecutive waveforms.

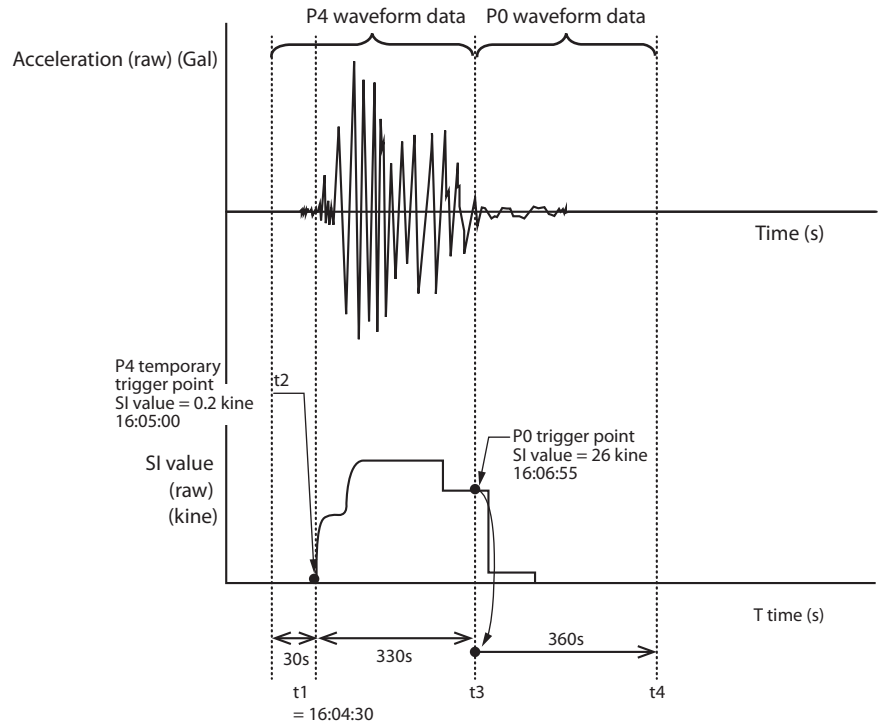

Explanatory diagram for maximum value recording without trigger update (automatic waveform recording)

Waveform header information (maximum value recording without trigger update)

Page		Rank	Before t4	Rank	t4 to t5	Rank	After t5
P0	Trigger time	(10)	01:23:09	–	Work	(6)	16:10:55
	Trigger SI value		0.1 kine		---		26.0 kine
P1	Trigger time	(6)	03:02:35	(7)	03:02:35	(8)	03:02:35
	Trigger SI value		0.3 kine		0.3 kine		0.3 kine
P2	Trigger time	(5)	03:04:10	(6)	03:04:10	(7)	03:04:10
	Trigger SI value		0.3 kine		0.3 kine		0.3 kine
P3	Trigger time	(9)	02:32:29	(10)	02:32:29	–	Work
	Trigger SI value		0.1 kine		0.1 kine		---
P4	Trigger time	–	Work	(5)	16:05:00	(5)	16:05:00
	Trigger SI value		---		32.0 kine		32.0 kine
P5	Trigger time	(7)	10:47:08	(8)	10:47:08	(9)	10:47:08
	Trigger SI value		0.2 kine		0.2 kine		0.2 kine
P6	Trigger time	(8)	10:07:33	(9)	10:07:33	(10)	10:07:33
	Trigger SI value		0.2 kine		0.2 kine		0.2 kine
P7	Trigger time	(1)	01:08:23	(1)	01:08:23	(1)	01:08:23
	Trigger SI value		45.3 kine		45.3 kine		45.3 kine
P8	Trigger time	(2)	04:01:07	(2)	04:01:07	(2)	04:01:07
	Trigger SI value		38.4 kine		38.4 kine		38.4 kine
P9	Trigger time	(3)	04:08:12	(3)	04:08:12	(3)	04:08:12
	Trigger SI value		33.3 kine		33.3 kine		33.3 kine
P10	Trigger time	(4)	01:06:53	(4)	01:06:53	(4)	01:06:53
	Trigger SI value		33.3 kine		33.3 kine		33.3 kine



## ■ Example of maximum value recording with trigger update

In the same way as for maximum value recording without trigger update, the chronological changes in acceleration and SI value are shown to illustrate the method of acceleration waveform recording when an earthquake occurs.

Chronological changes in waveform header information are also shown in the waveform header information table (☞ P. 6-18).

(1)  $T \leq t_1$  (16:04:55) or  $T < t_2$  (16:05:00):

The current acceleration data record is updated, with P4 used as the work page. The trigger conditions are not satisfied.

(2)  $T = t_2$  (16:05:00):

Since the SI exceeds the SI of the header item P0 (0.1 kine), which has a rank of 10, and has reached 0.2 kine, the trigger conditions for recording are satisfied. Later, if the SI does not exceed 0.2 kine, the waveform data with  $t_2$  used as trigger will be recorded for 360 s and then the data will be saved.

(3)  $t_2 < T < t_3$  (16:05:25):

Since the SI has now been updated to a larger value, the trigger point is also updated.

(4)  $t_3 \leq T < t_4$  (16:05:50):

Since the SI reached its largest value at time  $t_3$  and will not be updated later,  $t_3$  becomes the trigger point. The waveform data for 30 s before  $t_3$  and the acceleration data for 330 s after  $t_3$  are saved. Other operations wait for completion of 360 s of waveform recording. Header information and work record area are not changed until the recording of waveform data for 360 s is completed.

(5)  $T = t_4$ :

Since the recording of the waveform data for 360 s has been completed at  $t_4$ , the work record area changes to P0, and P4 is retained as recorded waveform data. The header information is also updated.

Since, as the header information shows, the newly recorded P4 has the 5th largest SI, its rank becomes 5 and the rank of each of the former 5th and following waveforms is lowered by one.

(6)  $t_4 \leq T < t_5$  (16:05:40):

Since the largest SI value in the waveform data in P0, which has now become the work page, is at time  $t_4$ ,  $t_4$  becomes the trigger point. Also, since the waveform data before  $t_4$  has already been recorded in P4, the 360 s of waveform recording starts after trigger point  $t_4$ .

(7)  $T = t_5$ :

Since the waveform recording for 360 s has been completed at  $t_5$ , the work record area changes to P3 and P0 is retained as record data. The header information is also updated. The rank of P0 then becomes 6.

By means of sequences such as these, the waveform data from  $t_1$  to  $t_5$  is recorded onto two pages, P4 and P0. In this case, however, due to the effect of the acceleration of the previously recorded P4, the waveform of the later recorded P0 is not the 26.0 kine SI value waveform shown in the P0 header, but is rather a waveform with small acceleration. As a result, values calculated from the recorded waveform will not match the value in the header information.

Therefore, when analyzing the automatically recorded waveform data, it is necessary to check the trigger time in the header information to see whether there are consecutive waveforms.

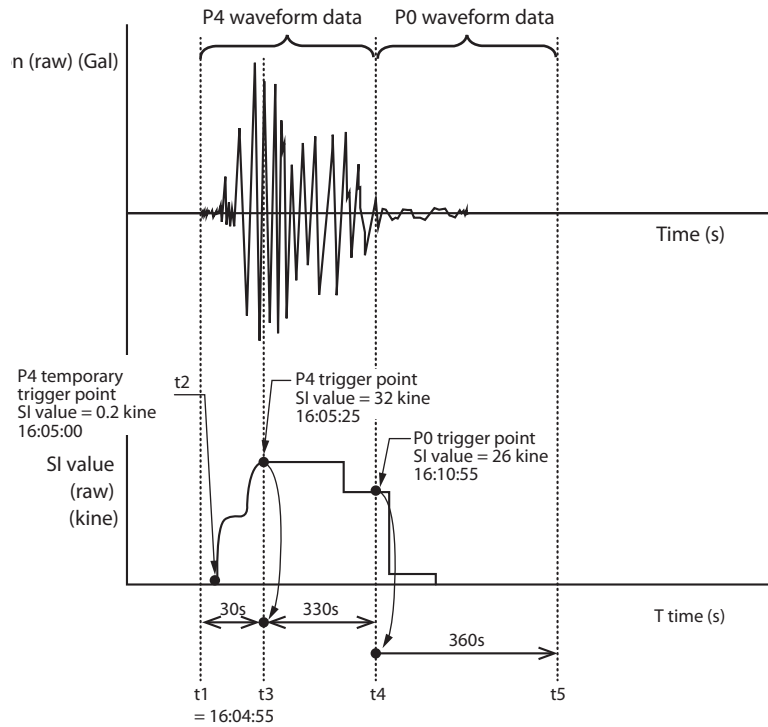

Explanatory diagram for maximum value recording with trigger update (automatic waveform recording)

Waveform header information (maximum value recording with trigger update)

Page		Rank	Before t4	Rank	t4 to t5	Rank	After t5
P0	Trigger time	(10)	01:23:09	–	Work	(6)	16:10:55
	Trigger SI value		0.1 kine		---		26.0 kine
P1	Trigger time	(6)	03:02:35	(7)	03:02:35	(8)	03:02:35
	Trigger SI value		0.3 kine		0.3 kine		0.3 kine
P2	Trigger time	(5)	03:04:10	(6)	03:04:10	(7)	03:04:10
	Trigger SI value		0.3 kine		0.3 kine		0.3 kine
P3	Trigger time	(9)	02:32:29	(10)	02:32:29	–	Work
	Trigger SI value		0.1 kine		0.1 kine		---
P4	Trigger time	–	Work	(5)	16:05:25	(5)	16:05:25
	Trigger SI value		---		32.0 kine		32.0 kine
P5	Trigger time	(7)	10:47:08	(8)	10:47:08	(9)	10:47:08
	Trigger SI value		0.2 kine		0.2 kine		0.2 kine
P6	Trigger time	(8)	10:07:33	(9)	10:07:33	(10)	10:07:33
	Trigger SI value		0.2 kine		0.2 kine		0.2 kine
P7	Trigger time	(1)	01:08:23	(1)	01:08:23	(1)	01:08:23
	Trigger SI value		45.3 kine		45.3 kine		45.3 kine
P8	Trigger time	(2)	04:01:07	(2)	04:01:07	(2)	04:01:07
	Trigger SI value		38.4 kine		38.4 kine		38.4 kine
P9	Trigger time	(3)	04:08:12	(3)	04:08:12	(3)	04:08:12
	Trigger SI value		33.3 kine		33.3 kine		33.3 kine
P10	Trigger time	(4)	01:06:53	(4)	01:06:53	(4)	01:06:53
	Trigger SI value		33.3 kine		33.3 kine		33.3 kine

## ■ Example of threshold value recording

In the explanatory diagram below for threshold value recording, chronological changes in acceleration and SI value are shown to illustrate the methods of acceleration waveform recording when an earthquake occurs.

Chronological changes in waveform header information are also shown in the waveform header information table (☞ P. 6-20).

Assuming that the current time is T, for purposes of illustration, the automatic waveform recording mechanism is explained along with the time flow (t1 to t4) shown in the figure and table.

The trigger conditions and the set threshold value for the following examples are the SI value and 10 kine, respectively.

(1)  $T \leq t1$  (16:04:30) or  $T < t2$  (16:05:00):

The current acceleration data record is updated, with P4 used as the work page. The trigger conditions are not satisfied.

(2)  $T = t2$  (16:05:00):

Since the SI exceeds the set threshold value (10 kine), the recording trigger conditions are satisfied. Waveform data with t2 used as the trigger is recorded for 360 s, and the data is saved.

(3)  $T = t3$ : (16:10:30)

Since the recording of waveform data for 360 s has been completed at t3, the work record area changes to P5, because it has the oldest trigger time, and P4 is retained as recorded waveform data. The header information is also updated. Since P4 has the newest trigger time, its priority becomes 1 and the rank of each of the other waveforms is lowered by one.

(4)  $t3 \leq T < t4$  (16:16:30):

Since, in the waveform data for P5, which has now become the work page, the SI value exceeds 10 kine at time t3, t3 becomes the trigger point. Also, since the waveform data before t3 has already been recorded in P4, the 360 s of waveform data recording starts after trigger point t3.

(5)  $T = t4$ :

Since the recording of waveform data for 360 s has been completed at t4, the work record area changes to P6, and P5 is retained as recorded waveform data. The header information is also updated. The rank of P5 then becomes 1.

By means of sequences such as these, the waveform data from t1 to t4 is recorded onto two pages, P4 and P5. In this case, however, due to the effect of the acceleration of the previously recorded P4, the waveform of the later recorded P5 is not the 32.0 kine SI value waveform shown in the P5 header, but is rather a waveform with small acceleration. As a result, values calculated from the recorded waveform will not match the value in the header information.

Therefore, when analyzing the automatically recorded waveform data, it is necessary to check the trigger time in the header information to see whether there are consecutive waveforms.

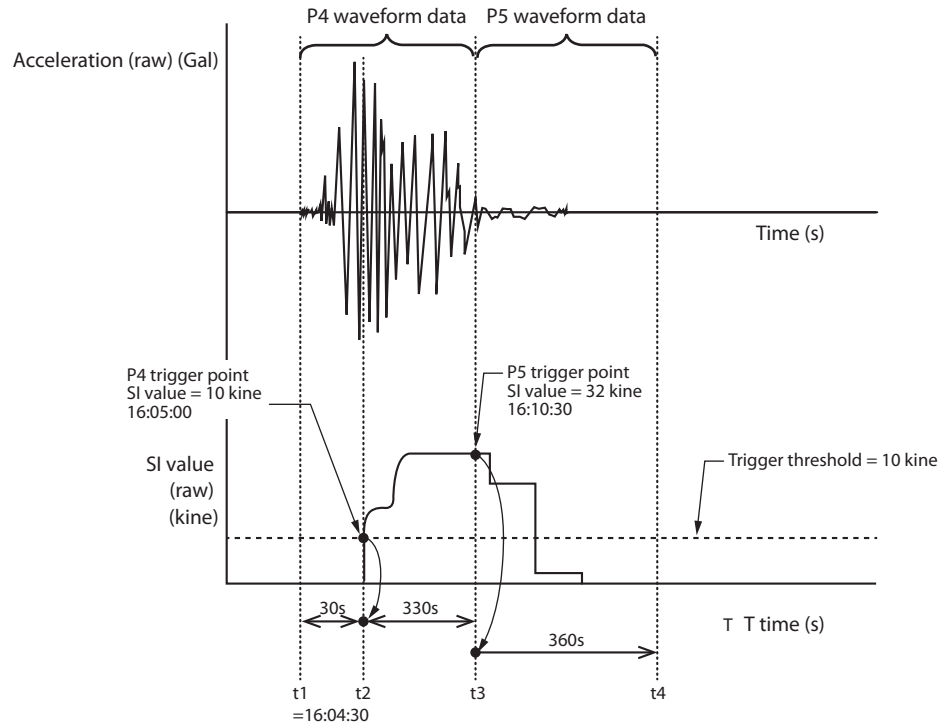

Explanatory diagram for threshold value recording (automatic waveform recording)

Waveform header information (threshold value recording)

Page		Rank	Before t3	Rank	t3 to t4	Rank	After t4
P0	Trigger time	4	09:30:17	5	09:30:17	6	09:30:17
	Trigger SI value		15.3 kine		15.3 kine		15.3 kine
P1	Trigger time	3	10:05:42	4	10:05:42	5	10:05:42
	Trigger SI value		11.1 kine		11.1 kine		11.1 kine
P2	Trigger time	2	13:23:00	3	13:23:00	4	13:23:00
	Trigger SI value		21.1 kine		21.1 kine		21.1 kine
P3	Trigger time	1	15:30:02	2	15:30:02	3	15:30:02
	Trigger SI value		10.5 kine		10.5 kine		10.5 kine
P4	Trigger time	-	Work	1	16:05:00	2	16:05:00
	Trigger SI value		---		32.0 kine		32.0 kine
P5	Trigger time	10	06:01:07	-	Work	1	16:10:30
	Trigger SI value		14.5 kine		---		32.0 kine
P6	Trigger time	9	06:08:12	10	06:08:12	-	Work
	Trigger SI value		23.0 kine		23.0 kine		---
P7	Trigger time	8	06:23:53	9	06:23:53	10	06:23:53
	Trigger SI value		13.3 kine		13.3 kine		13.3 kine
P8	Trigger time	7	07:08:23	8	07:08:23	9	07:08:23
	Trigger SI value		14.4 kine		14.4 kine		14.4 kine
P9	Trigger time	6	07:26:53	7	07:26:53	8	07:26:53
	Trigger SI value		21.3 kine		21.3 kine		21.3 kine
P10	Trigger time	5	08:23:53	6	08:23:53	7	08:23:53
	Trigger SI value		33.9 kine		33.9 kine		33.9 kine

## ■ Forced waveform recording

Forced waveform recording operates in standby mode to record data for one waveform. In forced waveform recording, waveform recording for 360 s is started by the recording start trigger sent from the loader.

### ! Handling Precautions

- If the start trigger request is sent again during recording, the waveform data is recorded again from that point.

## ■ Example of waveform recording

The figure below shows waveform data used by a 3-axis exciter in an earthquake waveform excitation experiment. The earthquake waveform data used for this experiment comes from an earthquake that occurred in southern Hyogo Prefecture and was observed at Kobe Marine Meteorological Observatory. The following shows a waveform graph based on part 360 s of recorded waveform data that was saved to a file using the loader and then displayed graphically using Microsoft Excel.

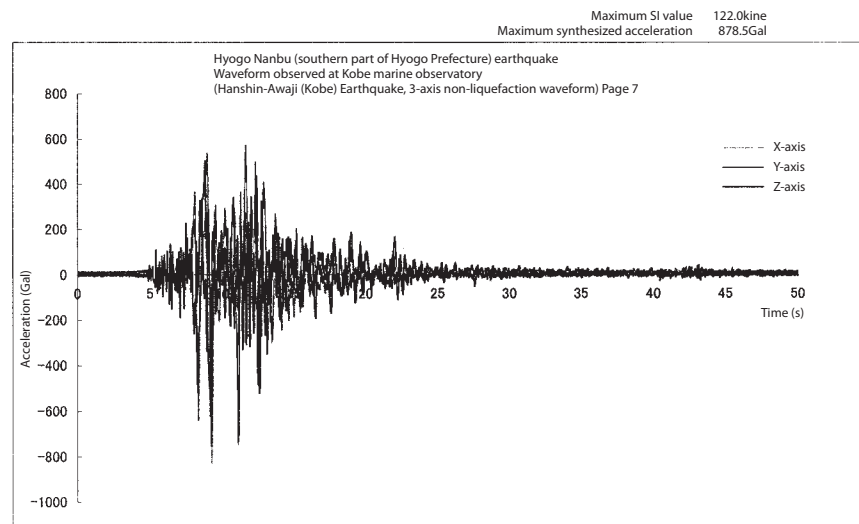

Waveform data recorded in an earthquake waveform excitation experiment

### ! Handling Precautions

- If a minor failure occurs due to a problem with battery backup, the clock will stop first as the battery voltage drops when external power is not supplied. When the power supply is restored, there will be a time lag. As necessary, check the time on the device.
- If the voltage drops further, either the clock data or the waveform data, or both, will be lost. In this case, when the power is restored, the time will be reinitialized (to 00:00:00 on January 1, 2050) and a minor failure state will occur until the correct date and time are set. Additionally, if the waveform data is lost, all previously recorded waveforms will be invalid. As necessary, check the device time and waveform data.
- The battery is not connected to the earthquake sensor at the time of shipment from the factory. The time is initialized data and no waveform data is recorded. Therefore, the unit will be in the minor failure state until the clock is set using the loader.
- The battery is supplied with the unit. It must be connected before operating the unit.

## 6 - 4 Vibration Detection and Liquefaction Judgment Functions

### ■ Vibration detection judgment function

It is possible to set conditions for three vibration detection output relays using AND and/or OR combinations of four parameters, SI PV value, synthesized AC acceleration PV, JMA seismic intensity PV, and liquefaction. The vibration detection conditions are set using the loader.

Default settings: no conditions are set, and the largest value is the threshold (for SI value, synthesized AC acceleration, and JMA seismic intensity scale equivalent value).

When the vibration detection conditions are satisfied, the vibration detection relays are turned ON.

Sample setting: {(SI PV value) OR (synthesized AC acceleration PV value)} OR {(JMA seismic intensity PV) AND (liquefaction)}

### ! Handling Precautions

- As shown below, the vibration detection judgment conditions of the SES70 are different from those for the older SES50/51/55/60 models. Be careful when using the unit without changing the default settings.

Note: Because the vibration detection judgment conditions differ depending on the user and can be freely changed, no default conditions are set. (No conditions are specified, and numeric values are fixed at their maximum.) If vibration detection relays are used, be sure to set the vibration detection judgment conditions.

	SES70	SES50/51/55/60 (old models)
Vibration detection judgment: OR conditions	None	None
Vibration detection judgment: AND conditions	None	SI value
Vibration detection judgment: SI value	300 kine	30 kine
Vibration detection judgment: Synthesized acceleration value	4000 Gal	300 Gal
Vibration detection judgment: JMA seismic intensity scale equivalent value	7.9	5.3

Note: By default the same conditions are set for vibration detection judgments 1 to 3.

If the synthesized AC acceleration PV is selected as a vibration detection condition, the synthesized AC adjusted acceleration value for control (default: 10 Hz) is set to the PV value in order to eliminate the high-frequency components of acceleration, which do not affect the amount of building damage.

Default: Synthesized AC adjusted acceleration value for calculation.

### ■ Liquefaction judgment function

Soil liquefaction is a phenomenon in which strong earthquake vibration of loose sandy soil saturated with water in places such as reclaimed land, former river beds, or coastal plains suddenly turns the ground, which until then was supporting structures, into something like mud. The ground loses the ability to support structures, which collapse, causing great damage.

When the liquefaction judgment conditions are satisfied, the liquefaction output (DO4) turns ON.

The liquefaction judgment function operates not by measuring the underground water level, but by identifying the characteristic acceleration waveforms associated with liquefaction. Liquefaction waveforms are identified by the four parameters listed below.

The liquefaction judgment function can be turned on or off using the loader. By default it is ON.

1. SI value: Checks whether the earthquake is sufficient in scale to cause liquefaction.
2. Synthesized AC acceleration for calculation: Identifies the surface waveform and liquefaction waveform.
3. Estimated displacement: Checks for amplified displacement due to liquefaction.
4. Zero-cross period (roughly equal to period÷2): Checks for lengthened acceleration period due to liquefaction.

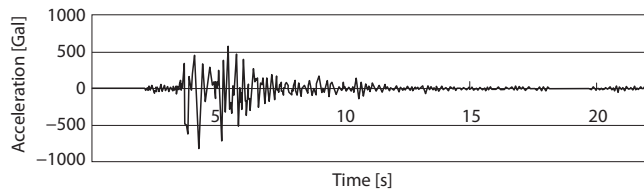

Normal earthquake waveform

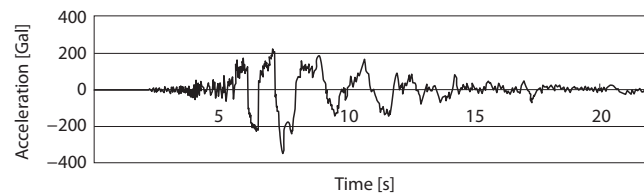

Liquefaction earthquake waveform

## 6 - 5 Noise Protection Function

This unit distinguishes intrusive noise, such as electromagnetic or impact waveforms, from acceleration signals, as shown in the figure below.

If noise occurs, the SI and synthesized AC acceleration values increase and the unit enters the noise protection state, in which incorrect determinations and incorrect output of the vibration detection judgment and liquefaction judgment are prevented. DO3 (noise protection output) turns ON.

When the noise detection conditions shown below are satisfied, the unit enters the noise protection state. Even if the noise detection conditions are no longer satisfied, the noise protection state continues for approximately 1 minute, during which time the vibration detection output and liquefaction output do not turn ON. If the noise protection state continues for the period of time specified for the noise protection continuous serious failure counter, the status is determined to be one of serious failure, and the serious failure output turns ON.

In the noise protection state, the minor failure output flashes and the LED also indicates noise protection. Additionally, the synthesized AC acceleration PV, SI PV, and JMA seismic intensity PV values change to 0 in the noise protection state, and the liquefaction judgment PV and vibration detection judgment PV turn OFF. However, the value of the actual output is kept for the hold time (at least 20 s) specified for the output hold process.

### 6 - 7 Output Functions (P. 6-29)

There are three noise detection methods: single-axis ratio noise detection, other-axis ratio noise detection, and zero-cross noise detection. Each is described below.

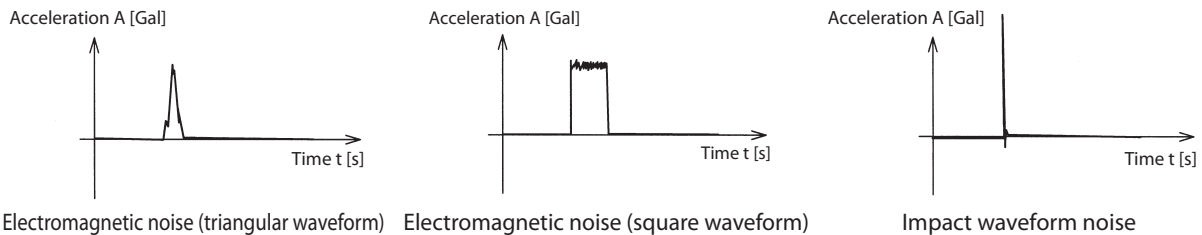

#### ● Single-axis ratio noise detection

In this detection method, if the AC acceleration for calculation deflects mostly in one direction (either positive or negative), which does not normally occur in vibration waveforms like those of an earthquake, it is judged to be single-axis ratio noise. Using the loader, an AC acceleration low limit (single-axis ratio noise low limit) can be set for this function.

Single-axis ratio noise low limit: 1 to 200 Gal  
 Default: 50 Gal  
 Setting interval: 1 Gal

#### ● Other-axis ratio noise detection (ORNP)

In this detection method, if the AC acceleration for calculation for a single axis becomes large and that of another axis is small, a situation which does not normally occur in vibration waveforms like those of an earthquake, it is judged to be other-axis ratio noise.

This function can be enabled or disabled by the loader. An AC acceleration low limit can be set for this function.

ORNP selection: Enabled/disabled  
 Default: Enabled  
 Z: ORNP low limit: 1 to 200 Gal  
 Default: 100 Gal  
 Setting interval: 1 Gal  
 X,Y:ORNP low limit: 1 to 200 Gal  
 Default: 50 Gal  
 Setting interval: 1 Gal



**● Zero-cross noise detection (ZCN)**

In this detection method, if an AC acceleration for calculation having a long period occurs, which is not normal for vibration waveforms like those of an earthquake, it is judged to be zero-cross noise.

A zero-cross occurs when the AC acceleration value for calculation changes from positive to negative, or vice versa. The period between one zero-cross and the next is the zero-cross noise period.

This function can be enabled or disabled by the loader. If "Enable" is selected, the zero-cross noise detection (ZCN) time can be set.

ZCN selection

Default: Enable

ZCN time

Default: 20 s

Setting interval: 1 s

Acceleration A [Gal]

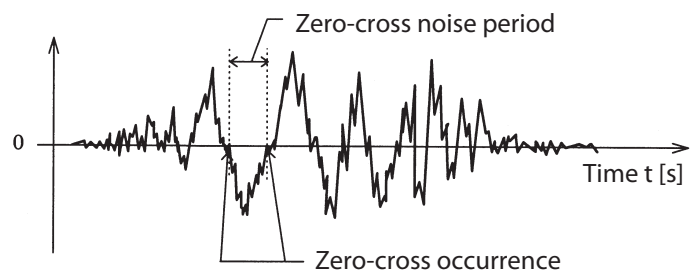

## 6 - 6 Error Diagnosis Functions

This unit executes various error diagnoses during operation in order to ensure high reliability.

The diagnosis results can be checked using the serious failure output (DO2), minor failure output (DO1), or LED indicators on the device. Additionally, error diagnosis details can be checked with the loader.

Error	Failure level				Mode				Condition for canceling error detection state*2
	Reset	Serious	Minor	Noise detection	Initialize	Measurement	Standby	Maintenance	
Watchdog timer error	●				●	●	●	●	Mode change to Initialize
Memory error		●			●	●	●	●	Mode change to Initialize
A/D converter error		●			●	●	●	●	Return of device to normal
Sensor built-in clock error		●			●	●	●	●	Mode change to Initialize
Vibration detection output error		●			●	●	●	●	Mode change to Initialize
Other H/W errors		●			●	●	●	●	Mode change to Initialize or return of device to normal*3
Accelerometer error		●					●*1	●	Accelerometer self-diagnosis execution
Acceleration error		●			●	●	●	●	Return of device to normal
Inclination error (serious)		●			●	●	●	●	Return of device to normal
Acceleration noise continuous error		●			●	●	●	●	Return of device to normal
Battery level error			●		●	●	●	●	Return of device to normal
Temperature error (serious)		●			●	●	●	●	Return of device to normal
Sensor built-in clock data error			●		●	●	●	●	Return of device to normal
Inclination error (minor)			●		●	●	●	●	Return of device to normal
Temperature error (minor)			●		●	●	●	●	Return of device to normal
Acceleration noise error				●	●	●	●	●	Return of device to normal

\*1. In standby mode, error diagnosis of the accelerometer is done using the loader.

●: Applicable

\*2. The table shows the conditions other than recycling the power.

\*3. Since other hardware errors have multiple possible causes, the conditions for ending the error detection state vary.

### ■ Failure level standards

#### 1. Reset

This is a serious failure that affects all functions.

Operation cannot continue. If this occurs, do a forced reset to change the mode to initialization mode.

Note: A forced reset is done when this failure occurs, and therefore it is not possible to check the loader.

#### 2. Serious failure

This failure may affect control output such as vibration detection output and liquefaction detection output.

Serious failure output (DO2) turns ON and minor failure output (DO1) turns ON or starts flashing. The serious failure LED is also lit. With regard to control output in the serious failure state, vibration detection output turns OFF, liquefaction output turns OFF, and AO is fixed at 3 mA (about -3 %).

#### 3. Minor failure

This failure does not affect control output, but a check should be made for errors in waveform recording and clock data storage, as well as clock data errors. The installation conditions should also be checked.

The minor failure output (DO1) turns ON and the minor failure LED is also lit. In the minor failure state, the vibration detection output and liquefaction output continue to operate.

#### 4. Noise detection

A signal other than a vibration waveform has been detected. This may affect the calculated results.

The noise protection output (DO3) is turns ON, and the LED indicates noise detection. In the noise protection state, the synthesized AC acceleration PV, SI PV, and JMA seismic intensity PV are 0. The liquefaction judgment PV and vibration detection judgment PV turn OFF.

## ■ Diagnostic functions according to the mode

1. Initialization mode  
Errors are detected, except for accelerometer errors. If any serious failure occurs, the device enters the system error state in standby mode.
2. Measurement mode  
Errors are detected, except for accelerometer errors.
3. Standby mode  
Errors are detected, except for accelerometer errors.  
Accelerometer diagnosis can be initiated by a communications command.
4. Maintenance mode  
All diagnoses are possible.

## ■ Various error diagnosis functions

1. Watchdog timer function (reset)  
The watchdog timer circuit monitors CPU operation to check for problems such as an infinite loop.
2. Memory error diagnosis function (serious failure)  
This diagnostic function monitors the status of the memory device that stores the settings, waveform records, etc., and detects any errors.
3. A/D converter error diagnosis function (serious failure)  
Monitors the status of the A/D converter (which is external to the CPU) and detects any errors.
4. Sensor built-in clock error diagnosis function (serious failure)  
Monitors the status of the clock IC that controls the date and time, and detects any errors.
5. Vibration detection output error diagnosis function (serious failure)  
Unused contacts of the vibration detection output relay are monitored. If the monitored operation is different from the vibration detection judgment, a vibration detection output circuit failure is diagnosed.
6. Diagnosis function for other hardware errors (serious failure)  
Other hardware errors are detected.
7. Accelerometer error diagnosis function (serious failure)  
The diagnostic circuit electrically activates the movable electrode of the accelerometer, which is built into the earthquake sensor for error diagnosis, to detect operational errors of the accelerometer. Additionally, this function detects errors in accelerometer adjustment data and output.
8. Inclination error (minor/serious) diagnosis function (minor failure and serious failure)  
The inclination acceleration for the X- and Y-axis is calculated from the measured acceleration. If it is  $\pm 250$  Gal or more (approximately  $15^\circ$  or more), there is considered to be a small inclination and a minor failure state. If the acceleration exceeds  $\pm 500$  Gal (approximately  $30^\circ$  or more), there is considered to be a large inclination and a serious failure state.
9. Acceleration error (serious failure)  
The Z-axis inclination acceleration is calculated from the measured acceleration. If it is  $\pm 200$  Gal or more, there is an acceleration error and a serious failure.

10. Diagnosis function for acceleration noise error (noise detection) and acceleration noise continuous error (serious failure) The acceleration is analyzed for characteristics of non-earthquake waveforms to judge whether or not a failure has occurred. If this noise error is detected, the unit enters the noise detection state, and then the noise protection state, in which it is prevented from updating control outputs such as vibration detection output, liquefaction output, and analog output. Additionally, if the noise protection state continues for the period of time that has been preset for the noise protection continuous serious failure counter, there is considered to be a serious failure. The acceleration noise error is reset 1 minute after the noise detection has been resolved.
11. Battery level error diagnosis function (serious failure)  
Any voltage drop of the battery is analyzed to determine whether an error has occurred.
12. Temperature error diagnosis function (minor failure and serious failure)  
The temperature inside the earthquake sensor is monitored to determine whether an error has occurred.
13. Sensor built-in clock data error diagnosis function (minor failure)  
This diagnosis function detects erroneous data in the device controlling the date and time.  
In checking whether the time has been initialized or is erroneous, if the year is between 2050 and 2099, the time is judged to be erroneous.  
If the clock data backed up by the battery is lost, the unit is initialized to 00:00:00 on January 1, 2050 and the unit enters the minor failure state.  
Note that the battery is not connected to the unit before shipment from the factory. Therefore, the unit has initialized time data and is in the minor failure state. To reset this minor failure state, set the date and time using the loader.

## 6 - 7 Output Functions

### ■ Output update and hold processes

After the low cutoff process and hold process are applied to the SI value, synthesized AC acceleration, and JMA seismic intensity scale equivalent value calculation results, and the hold process is applied to the vibration detection and liquefaction judgment results, they are reflected by the AO (4–20 mA), relay (1a), and DO4 output (transistor output (Nch open drain)). The minor failure and serious failure determinations and noise protection are directly reflected by the DO1, DO2, and DO3 (transistor output (Nch open drain)) outputs.

The outputs are updated at 10 ms intervals.

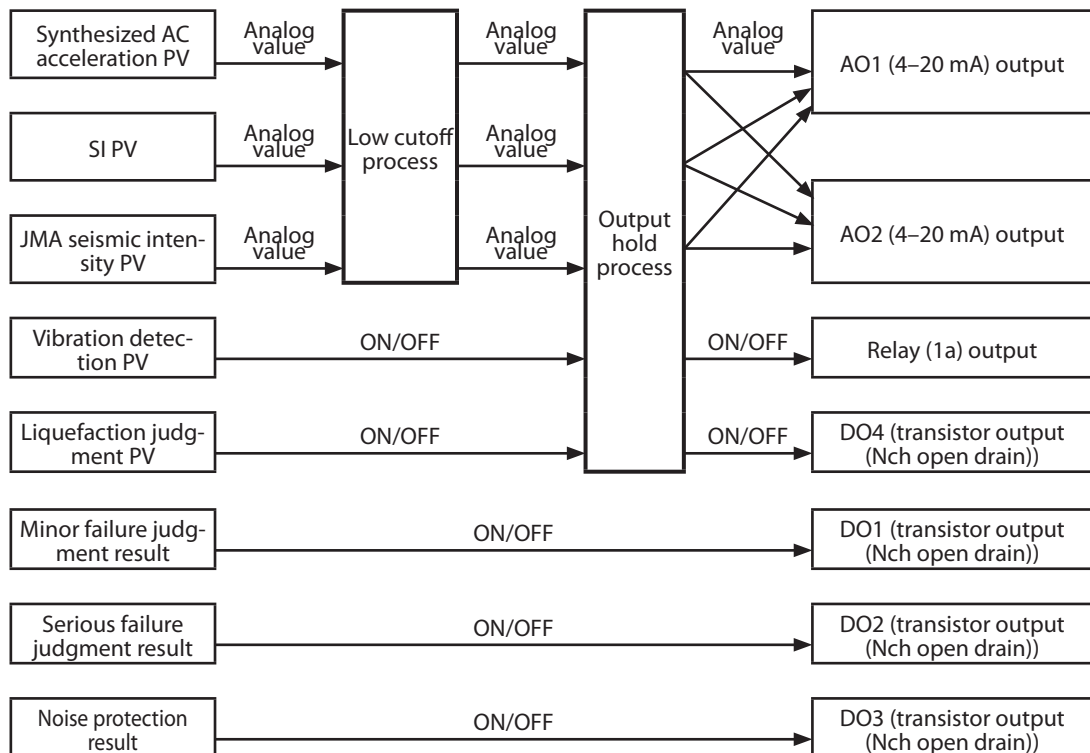
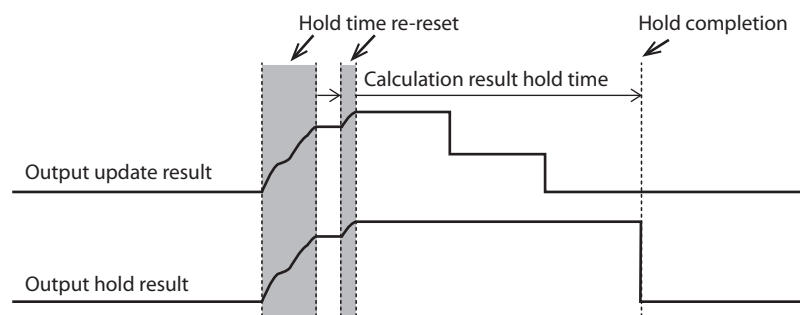

Diagram of output functions

### ■ Hold process

This process holds the results of the output update process. The hold time can be set within a range of 20 seconds to 7 days.

If the result of the AO output update process is larger than the current value, peak hold begins. If the result of the output update process is equivalent to or smaller than the current value, the status of peak hold is checked. If the peak hold time has ended, it is updated. If the hold time is continuing, it is not updated.



Example of calculation result hold process

For relay output, if the ON/OFF output of DO4 is held “ON,” and the result of the output update changes from OFF to ON, the hold begins.

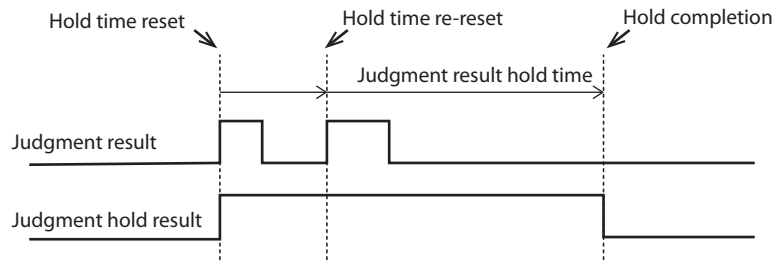

Example of judgment result hold process

## ■ Manual output

### (1) PV manual output

For the the SI value (PV), synthesized AC acceleration (PV), JMA seismic intensity scale equivalent value (PV), liquefaction judgment (PV), the following values can be output manually using the loader in standby mode:

SI value (PV):	0 to 300 kine
Synthesized AC acceleration (PV):	0 to 4000 Gal
JMA seismic intensity scale equivalent value (PV):	0 to 7.9
Liquefaction judgment (PV):	ON/OFF

Note: Since the PV is manually output, the AO and DO outputs corresponding to the preset PV turn ON. (For example, the vibration detection relay turns ON/OFF in connection with the vibration detection judgment threshold value.)

### (2) AO/DO manual output

For the AO outputs of the SI value, synthesized AC acceleration, JMA seismic intensity scale equivalent value, the relay outputs (1, 2, 3) of the vibration detection judgment, the liquefaction judgment DO3 output, the minor failure DO1 output and serious failure DO2 output, the following values can be output manually using the loader in standby mode:

AO output:	0 to 100% (4–20 mA) output variable change
Relay output:	ON/OFF variable change
DO3 output:	ON/OFF variable change
DO4 output:	ON/OFF/blinking variable change
DO1 output:	ON/OFF/blinking variable change
DO2 output:	ON/OFF variable change

Note: An internal judgment is set for DO outputs. Accordingly, if negative logic is chosen for the minor failure output (DO1), serious failure output (DO2), and noise protection output (DO3), the settings will differ from the actual DO terminal status.

## ■ Output adjustment (constant drift)

Constant drift of the AO output or vibration detection output can have four possible causes:

- (1) Constant interfering vibration
- (2) Constant electrical or electromagnetic field noise
- (3) Sensor internal circuit noise
- (4) AO output circuit drift (0.3 % FS max.)

Before adjusting the output, take corrective measures against causes (1) and (2) above, such as changing the installation location and ambient environment conditions.

### ● PV bias

Setting a negative bias for the SI raw value and synthesized acceleration raw value is effective for causes (1) to (3) above.

However, a negative value of less than 4 mA may be output. Additionally, since the measured value will be small when there is no noise or interference, the AO output will be small, and the vibration detection output may not turn ON. Both of the default settings are 0.

### ● PV low cutoff

Setting a low cutoff for the SI PV, synthesized acceleration PV, and JMA seismic intensity PV is effective for causes (1) to (3) above.

However, if the measured value is less than the preset low cutoff value, the AO output will be 0 % and the vibration detection output will be OFF. The default settings are shown below.

	Default
SI PV Low Cutoff	1.0 kine
Synth. Accel. PV Low Cutoff	5.0 Gal
M.V.E.V. (JMA) PV Low Cutoff	1.0.

Note: The default settings are different from those of the SES60. All default settings of the SES60 are 0.

### ● AO bias

By adjusting the bias for drift (0.3 % FS max.) of the analog output circuit, which is cause (4) above, constant drift error can be reduced.

To eliminate causes (1) to (3), make the adjustment in the manual output state.

## ■ Output adjustment (high-frequency noise)

To eliminate the adverse effects of the high-frequency component of acceleration, it is effective to use the acceleration value for control, with a low cutoff frequency for the acceleration filter.

☞ 6 - 2 Internal Calculation Processes (P. 6-7).

Set the synthesized AC acceleration PV to the synthesized AC adjusted acceleration value for control. If any adverse effect is found even with this setting, decrease the cutoff frequency of the acceleration filter for control.

Default: 10 Hz

■ Output selection

SES70 output function or SES60-compatible output functions can be selected with the loader.

The SES60-compatible output function is used to make the following revised SES70 output functions the same as those of the SES60.

	SES70 output function	SES60-compatible output function
Vibration detection judgment	Vibration detection judgment 1, 2, 3	Vibration detection judgment 1 only
Vibration detection output	Vibration detection outputs 1, 2, 3	Vibration detection output 1 only
Minor failure output function*	For Present/Minor	For Present/Noise/Minor
Noise protection output (DO3)	ON	OFF
Maintenance sequence	Phases 1–3	Phase 1 only

\*In the minor failure output function, functions used for Present/Minor will just change to those used for Present/Noise/Minor. The selection of settings will not automatically change. (For example, a function exclusively used for Minor will not automatically change to a function used for Present/Minor.) If necessary, change the selection of settings.

Note: Only by applying the SES60-compatible output function to the output function selection, the SES70 cannot do the same operations as the SES60.

If necessary, change the following. The table below shows the comparison of default settings. If default settings are modified, change them as needed.

	SES70 output	SES60-compatible output
Vibration detection judgment: OR conditions	None	SI Value
Vibration detection judgment: AND conditions	None	None
Vibration detection judgment: SI value	300 kine	30 kine
Vibration detection judgment: Synthesized acceleration value	4000 Gal	300 Gal
Vibration detection judgment: JMA seismic intensity scale equivalent value	7.9	5.3
Waveform recording	Threshold value recording	Maximum value recording with trigger update
Value used for the maximum value recording with trigger update	SI value	SI value
Value used for the maximum value recording without trigger update	SI value	No function
Value used for the threshold value recording	SI value	SI value
Threshold: SI Value	1 kine	30 kine
Threshold: Synthesized acceleration	5 Gal	300 Gal
Threshold: JMA seismic intensity scale equivalent value	1.0	5.3
RS-485 transmission speed	38400 bps	19200 bps
Minor failure output (DO1) function selection	Positive logic value: For Present/Minor	Positive logic value: For Present/Minor joint use (in terms of functions, acts as Present/Noise/Minor)
Serious failure output (DO1) function selection	Positive logic	Positive logic
SI PV Low Cutoff	1.0 kine	0.0 kine
Synth. Accel. PV Low Cutoff	5.0 Gal	0.0 Gal
M.V.E.V. (JMA) PV Low Cutoff	1.0.	0.0



## ■ Outputs according to mode

The various outputs have different output result processing depending upon which of the four modes the unit is in, and the unit's operating state. For the output in each mode, the operation described in the lowest row of the "Operating state" column has priority.

Mode	Operating state	Vibration detection output (relays 1, 2, 3)	Liquefaction detection output (DO4)	Synthesized AC acceleration, SI value, JMA seismic intensity scale equivalent value (AO1, 2)	Minor failure output (DO1)	Serious failure output (DO2)	Noise protection output (DO3)	
Initialization	Normal operation	OFF			Fast ON/OFF*1	OFF	OFF	
Measurement	Normal operation	Hold process output			OFF	OFF	OFF	
	During minor failure				ON			
	During noise protection	Noise + hold process output			OFF		ON	
	During serious failure	OFF fixed value	Approx. 3.5 mA		ON	ON	OFF	
Standby	Normal operation	Hold process output			Slow ON/OFF*2	OFF	OFF	
	During minor failure							
	During noise protection	Noise + hold process output						
	During serious failure	OFF	Approx. 3.5 mA			ON	OFF	
	During system error					ON	OFF	
	Manual output	Manual output						
Maintenance	Normal operation	Maintenance sequence output						

\*1. Fast ON/OFF: 0.5 s / 0.5 s

\*2. Slow ON/OFF: 0.1 s/0.1 s

Note: For the output in each mode, the operation described in the lowest row of the "Operating state" column has priority.

### Failure output conditions

Minor failure: Positive logic, shared output

Serious failure: Positive logic

Noise protection: Positive logic

### ⚠ Handling Precautions

- Take into account that analog output may fluctuate if the power increases slowly during startup.

## 6 - 8 Maintenance Sequence

By switching to maintenance mode using diagnosis input (DI1) or the loader, the operation of the outputs and accelerometer can be checked. The following describes the maintenance sequence for checking output operation.

### ■ Maintenance sequence

#### ● Mode change to maintenance mode

- (1) In measurement mode, when the DI1 is ON continuously for 2 s or longer, or when a mode transition request from the loader or RS-485 is received, the mode changes to maintenance mode.

#### Phase 1

- (2) The DO1 minor failure output becomes a slow ON/OFF (0.5 s/0.5 s) and the AO1 and 2 outputs become 100 % (20 mA) outputs.
- (3) After 1 s has elapsed, the DO2 serious failure output is turned ON.
- (4) After another 1 s has elapsed, the vibration detection output is turned ON.
- (5) The diagnosis of the accelerometer starts 30 s after the mode changes to maintenance mode.
- (6) When the diagnosis of the accelerometer has been completed, the DO1 minor failure output starts flashing, the DO2 serious failure output is turned OFF, the AO1 and 2 outputs change to 0 % (4 mA), and the DO4 liquefaction output enters the slow ON/OFF status. (The vibration detection output remains ON.)

#### Phase 2

- (7) If the DI1 input remains ON for 2 s or longer, or if a diagnostic phase change request from the loader or RS-485 is received, vibration detection output 1 and the DO4 liquefaction output are turned OFF, the DO1 minor failure enters the slow ON/OFF status, and the AO1 and 2 outputs change to 50 % (12 mA).
- (8) One second later, the DO2 is turned ON.
- (9) After another second, vibration detection output 2 is turned ON.
- (10) Then, 28 seconds later, the DO1 minor failure output starts flashing, the DO2 serious failure output is turned OFF, the AO1 and 2 outputs change to 0 % (4 mA). (Vibration detection output 2 remains ON.)

#### Phase 3

- (11) If the DI1 input remains ON for 2 s or longer, or if a diagnostic phase change request from the loader or RS-485 is received, vibration detection output 2 is turned OFF, the DO1 minor failure output enters the slow ON/OFF status, and the AO1 and 2 outputs change to 10 % (5.6 mA).
- (12) Two seconds later, vibration detection output 3 is turned ON.
- (13) Then, 28 seconds later, vibration detection output 3 is turned OFF, the DO1 minor failure output starts flashing, the DO3 noise protection output is turned ON, and the AO1 and 2 outputs change to 0 % (4 mA).

After completion of phase 3

(14) Under these circumstances, if the DI1 input remains ON for 2 s or longer, or when a mode change request from the loader or RS-485 is received, the mode changes to initialization mode, the DO1 minor failure output enters the fast ON/OFF status, and the DO3 noise protection output is turned OFF. (Maintenance mode ends.)

(15) In step 13, if there is no mode change request for 20 minutes (timeout period), the mode changes to initialization mode. (Maintenance mode ends.)

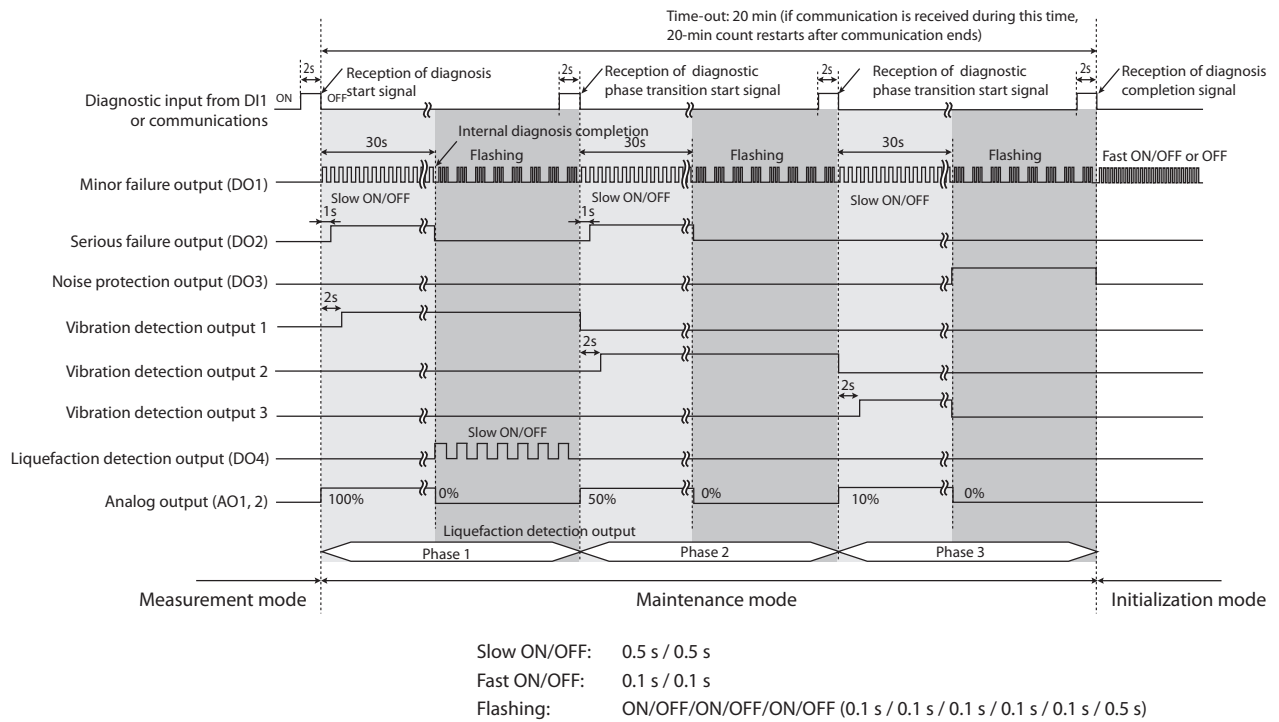

Maintenance sequence diagram

## 6 - 9 LED Output Functions

Four LEDs indicate the mode and error status.

In initialization mode, as shown in the table below, the LED indication automatically changes in the order shown, beginning from the top row.

LED1: Minor failure

LED2: Serious failure

LED3: Noise protection

LED4: Operation mode

Mode	Status	Minor failure LED 1 (red)	Serious failure LED 2 (red)	Noise LED 3 (red)	Mode LED 4 (green)
Initialization mode	Any status	○	○	○	●
		●	○	○	●
		●	●	○	●
Measurement mode	No error	●	●	●	○
	Minor failure	○	●	●	○
	Serious failure	●	○	●	○
	Protection	●	●	○	○
	Minor & serious failure & protection	○	○	○	○
Maintenance mode (phase 1)	30 s after the mode transition	●	●	●	◆
	After 30 s	●	●	●	★
Maintenance mode (phase 2)	30 s after the transition to phase 2	●	●	●	◆
	After 30 s	●	●	●	★
Maintenance mode (phase 3)	30 s after the transition to phase 3	●	●	●	◆
	After 30 s	●	●	●	★
Standby mode	No error	●	●	●	▲
	Minor failure	○	●	●	▲
	Serious failure	●	○	●	▲
	Protection	●	●	○	▲
	Minor & serious failure & protection	○	○	○	▲

○: ON, ◆: Fast blinking, ▲: Slow blinking, ★: Flashing, ●: OFF

Slow ON/OFF (0.5 s / 0.5 s)

Fast ON/OFF (0.1 s / 0.1 s)

Flashing: ON/OFF/ON/OFF/ON/OFF (0.5 s/0.1s/0.1 s/0.1s/0.1 s/0.1 s)

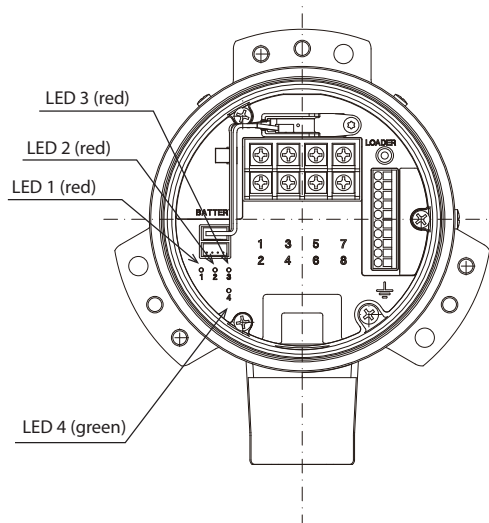

# Chapter 7. LOADER ACCESS DATA

---

## ■ Real-time data monitoring data

It is possible to read and write the internal data from the earthquake sensor using the SLP-SE7 Smart Loader Package for the Intelligent Earthquake Sensor, which runs on a personal computer.

However, note that the details of this chapter may differ from the actual specifications of the loader.

☞ SLP-SE7 Smart Loader Package for SES70 Intelligent Earthquake Sensor, No. CP-UM-5756E

### ● Monitoring data

The following data can be read in real time on the PC monitor:

- Operation mode
- Errors details
- SI PV
- Synthesized acceleration PV
- JMA seismic intensity scale equivalent PV
- AC acceleration (X-, Y-, and Z-axis) for operation and control
- Minor failure output (DO1)
- Serious failure output (DO2)
- Noise protection output (DO3)
- Vibration detection output (relay) 1, 2, 3
- Liquefaction detection output (DO4)
- Sensor built-in clock
- AO1, AO2
- Earthquake sensor model number, etc.

### ● Trend monitoring screen

On the trend monitoring screen of the real-time monitor, graphs for SI PV, synthesized acceleration PV, adjusted acceleration value for calculation, AC acceleration for calculation, and inclination acceleration value for calculation can be displayed.

● Detailed error data

Detailed information on detected errors, such as serious failure, noise detection, and minor failure, is summarized by error level, and is reflected in the general error information.

Error	Error level		
	Serious failure	Minor failure	Noise detection
Memory error	●		
A/D converter error	●		
Sensor built-in clock error	●		
Vibration detection output error	●		
Other hardware error	●		
Accelerometer error	●		
Acceleration error	●		
Inclination error (serious)	●		
Acceleration noise continuous error	●		
Battery level error		●	
Temperature error (serious)	●		
Temperature error (minor)		●	
Sensor built-in clock data error		●	
Inclination error (minor)		●	
Acceleration noise error			●

With regard to detailed error information, it is possible to switch between current errors and errors that occurred previously during operation and were stored.

! Handling Precautions

- To clear the stored information, reset the power or change the mode from standby mode to initialization mode.

■ Changing of settings

The following earthquake sensor settings can be changed:

● Date and time setting

The date and time of the earthquake sensor's built-in clock can be set. There are two methods of setting: directly inputting numeric values and synchronizing the date and time with the clock of the personal computer using the loader. If the clock data is faulty, the unit enters the minor failure status. Initial value: 00:00:00 on January 1, 2050.

● SI type

SI 1 or SI 2 can be chosen.  
 SI 1: 7 natural periods, vector projection in 8 directions  
 SI 2: 24 natural periods, vector projection in 16 directions  
 Default SI type: SI 1

● Synthesized acceleration type

The synthesized AC acceleration PV value is selected from the synthesized AC acceleration for calculation and the synthesized AC acceleration for control.  
 Default: AC acceleration for control

● Number of synthesized AC acceleration operation axes for calculation and control

The synthesized axes of the synthesized AC acceleration for calculation and control are chosen from the 2-axis horizontal plane (X and Y) or 3 axes.  
 Default: 2 axes for calculation, 3 axes for control.

### ● JMA seismic intensity scale calculation method selection

Either of two calculation methods can be chosen, that is, calculation using the SI PV only or using the SI PV and synthesized AC acceleration. The default setting is the equation that uses SI PV and synthesized AC acceleration.

### ● Vibration detection judgment setting

Three vibration detection judgment conditions (J.V.D.1, J.V.D.2, J.V.D.3) can be set. Logical operations for the SI value, synthesized AC acceleration, JMA seismic intensity scale equivalent value, and liquefaction judgment value to turn ON or OFF the vibration detection output can be selected for vibration detection judgment conditions. Threshold values for the SI value, synthesized AC acceleration, and JMA seismic intensity scale equivalent value, which are used for vibration detection judgment, can be set.

Item name	Setting	Default *
Vibration detection judgment 1 AND condition Vibration detection judgment 1 OR condition	The logical sum of the AND condition and the OR condition is used as the vibration detection judgment condition. Note that both the AND and OR conditions cannot be set for the same target item. AND condition: The AND condition for the set target item is used as the judgment condition. OR condition: The OR condition for the set target item is used as the judgment condition.	AND condition: none OR condition: none
Vibration detection judgment 1 SI value	1–300 kine	300 kine
Vibration detection judgment 1 synthesized AC acceleration value	5–4000 Gal	400 Gal
Vibration detection judgment 1 JMA seismic intensity scale equivalent value	1.0–7.9	7.9

Note: The above settings also apply to vibration detection judgments 2 and 3.

\* The default vibration detection judgment settings for the SES70 differ from those of SES60.

 ■ Vibration detection judgment function (P. 6-22)

### ● Output hold time setting

Hold time values can be set for the control outputs, such as vibration detection output (relay), liquefaction output (DO4), SI value, synthesized AC acceleration, and JMA seismic intensity scale equivalent value (AO1, 2).

Item name	Setting	Default
Vibration detection output (relay output) hold time	20–604800 s (1 week max.)	20 s
Liquefaction detection output (DO4 output) hold time		
AO output (AO1 and AO2) hold time		

### ● AO span selection

Span allocation of 0–100 % (4–20 mA) for the SI value, synthesized AC acceleration value, and JMA seismic intensity scale equivalent value output (AO1, 2) can be changed.

Item name	Setting	Default
SI value AO span	50, 100, 150, or 200 kine/20 mA	200 kine
Synthesized AC acceleration AO span	500, 1000, 2000, or 3000 Gal/20mA	2000 Gal
JMA seismic intensity scale AO span	5.0 or 8.0/20 mA	8.0

Note: In addition to selection, direct input of one of the 4 numeric values is possible.

### ● AO output selection

The output of AO1 and AO2 can be selected.

Item name	Setting	Default
AO1 selection	Synthesized AC acceleration PV, SI PV, or JMA seismic intensity scale PV	Synthesized AC acceleration PV
AO2 selection		SI PV

### ● PV bias

A bias calculation can be applied to the SI PV, synthesized AC acceleration PV, and JMA seismic intensity scale PV.

Item name	Setting	Default
SI PV bias	-30.0 to +30.0 kine	0.0 kine
Synthesized AC acceleration PV bias	-400.0 to +400.0 Gal	0 Gal
JMA seismic intensity scale PV bias	-3.0 to +3.0	0

### ● PV low-cut

A low cutoff can be set for the SI PV, synthesized AC acceleration PV, and JMA seismic intensity scale PV.

Item name	Setting	Default
SI PV low-cut	0.0 to 30.0 kine	1.0 kine
Synthesized AC acceleration PV low cutoff	0.0 to 400.0 Gal	5.0 Gal
JMA seismic intensity scale PV low cutoff	0.0 to 3.0	1.0

Note: The default settings of the SES70 are different from those of the SES60.  
All of the 3 settings for SES60 are 0.

### ● AO ratio

The ramp for the analog output can be adjusted.

Item name	Setting	Default
AO1 ratio	0.900–1.100	1.000
AO2 ratio		

### ● AO bias

The drift for the analog output can be adjusted.

Item name	Setting	Default
AO1 bias	-5.0 to +5.0 %	0.0 %
AO2 bias		

### ● Noise protection continuous serious failure judgment time

It is possible to set a time required to judge serious failure caused by continuous noise protection.

Setting: 5–10080 min

Default: 30 min

### ● Noise protection low limit

Noise protection works using multiple logical processes. One logical process determines noise if the AC acceleration deflects largely in one direction, either positive or negative. This logical process determines the AC acceleration low limit.

Single axis ratio NP lower limit: 1–200 Gal

Default: 50 Gal

Another logical process determines noise when the AC acceleration deflects largely along a certain axis (X, Y, or Z), in either positive or negative directions, but deflection on other axes is small. Whether to use this logical process can be selected. In addition, the AC acceleration low limit when the logical process will be used can be set.

Other-axis ratio NP selection: Enable/Disable

Default: Enable

Z: Other-axis ratio NP lower limit: 1–200 Gal

Default: 100 Gal

X,Y: Other-axis ratio NP lower limit: 1–200 Gal

Default: 50 Gal



### ● Zero-cross noise detection selection

Zero-cross noise detection can be enabled or disabled. If this function is enabled, a zero-cross period can be set.

Default: Enabled

Zero-cross period: 20 s

### ● Minor failure output function (DO1) selection

The minor failure output (DO1) can be set to "Present/Minor (minor failure, mode)" or "Minor."

 ■ Outputs according to mode (P. 6-33)

Default: Present/Minor, positive logic

### ● Serious failure output (DO2) logic selection

The serious failure output (DO2) logic can be set to positive or negative logic.

Default: Positive logic

### ● Noise output (DO3) logic selection

The noise output (DO3) logic can be set to positive or negative logic.

Default: Positive logic

### ● Communication settings

The station address, RS-485, data format (parity check), baud rate, etc. can be set.

The data format is fixed at 8-bit data and 1 stop bit. For parity check only, "None" or "Even" can be chosen.

Item name	Setting	Default
Station address	0–126	1
RS-485 data format (parity)	None or even	Even parity
RS-485 baud rate	9600, 9200, or 38400 bps	38400 bps

### ● Liquefaction detection enable/disable setting

The liquefaction output can be enabled or disabled.

Default: Enable

### ● Restoring default settings

It is possible to reset the settings to the factory defaults.

Settings other than communication settings will be initialized to the default settings. All history records (such as waveforms) are deleted.

### ● Acceleration filter setting

The user can set a cutoff frequency for the low-pass filter that separates the X-, Y-, and Z-axis acceleration signal from the acceleration for calculation and acceleration for control. A cutoff frequency can be set for both the acceleration for calculation and acceleration for control.

Default: 30 Hz for calculation, 10 Hz for control.

### ● Output function selection

Either the SES70 output function or the SES60-compatible output function can be chosen.

The SES60-compatible output function is used to make the necessary changes in the SES70 output functions so that the SES70 has the same outputs as those of the SES60.

 ■ Output selection (P. 6-32)

Default: SES70 output function

## ■ Waveform recording

Using the loader, the recorded waveform data can be read out or deleted, and forced waveform recording can also be executed.

### ● Readout of recorded waveform data list

The header data (time stamp, SI value, synthesized AC acceleration, JMA seismic intensity scale equivalent value, and error flag, etc.) of the recorded waveform data can be read.

### ● Readout of recorded waveform data

Ten automatically recorded waveform records and one forced waveform recording can be read. The acceleration numeric values can also be displayed and graphed.

### ● File saving

The waveforms with their header data can be read and then saved to a file for analysis. At the same time, the configuration file is also saved.

### ● Forced waveform recording

Forced waveform recording can be started using the loader in standby mode.

### ● Waveform deletion

Data for ten automatic waveform recordings and one forced waveform recording can be deleted.

### ● Automatic waveform recording conditions

The user can select either maximum value with/without trigger update or threshold value as the criterion for recording. Additionally, the threshold value parameters can be set.

## ■ Manual output function

Each output can be set manually using the loader in standby mode. There are two manual output types as follows:

- PV manual output
- AO/DO manual output

### ● PV manual output

The following are manually output PVs.

- SI PV
- Synthesized acceleration PV
- JMA seismic intensity scale PV
- Liquefaction judgment PV

Since PVs are manually output, the related AO and DO outputs also turn ON/OFF. (For example, the vibration detection output relay turns ON/OFF in conjunction with the vibration detection judgment threshold.)

Item name	Setting	Initial value	Setting interval
SI PV	0–300 kine	*	1 kine
Synthesized AC acceleration PV	0–4000	*	1 Gal
JMA seismic intensity scale PV	0–7.9	*	0.1
Liquefaction judgment PV	Enable/Disable	*	—

\* Initial value refers to the output value set at the time when PV manual output was set for the manual output selection.

## ● AO/DO manual output

The following AO, DO, and relay outputs are manually output:

- AO1 manual output
- AO2 manual output
- Vibration detection output 1, 2, 3
- Minor failure output (DO1)
- Serious failure output (DO2)
- Noise protection output (DO3)
- Liquefaction detection output (DO4)

### AO manual output

Item name	Setting	Initial value	Setting interval
AO1 manual output	-10.0 to 110.0 %	*	0.1%
AO2 manual output	-10.0 to 110.0 %	*	0.1%

\* Initial value refers to the output value set at the time when AO/DO manual output was set for the manual output selection.

### Vibration detection output

Item name	Setting	Initial value	Setting interval
Vibration detection output 1	ON/OFF	*	-
Vibration detection output 2	ON/OFF	*	-
Vibration detection output 3	ON/OFF	*	-

\* Initial value refers to the output value set at the time when AO/DO manual output was set for the manual output selection.

### DO output

Item name	Setting	Initial value	Setting interval
Minor failure output (DO1)	ON/OFF/blinking	*1	-
Serious failure output (DO2)	ON/OFF	*1	-
Noise protection output (DO3)	ON/OFF	*1	-
Liquefaction detection output (DO4)	ON/OFF/blinking*2	*1	-

\*1. Note: Initial value refers to the output value set at the time when AO/DO manual output was set for the manual output selection.

\*2. The terminal's status is slow ON/OFF.

- An internal judgment is set for DO outputs. Accordingly, if negative logic is chosen for the minor failure output (DO1), serious failure output (DO2), or noise protection output (DO3), the settings will differ from the actual DO terminal status. The table below shows the relationship of the settings and the actual terminal status.

Item	Manual output setting	SES70 terminal status	
		With positive logic	With negative logic
Minor failure	OFF	OFF	ON
	ON	ON	OFF
	Blinking	Slow ON/OFF	Slow ON/OFF
Serious failure	OFF	OFF	ON
	ON	ON	OFF
Noise protection	OFF	OFF	ON
	ON	ON	OFF

## ■ Diagnosis and adjustment function

Bias adjustment and diagnosis of the accelerometer can be executed using the loader in standby mode.

### ● Zero adjustment

The bias is adjusted automatically so that the adjusted acceleration value is close to 0 Gal.

This adjustment is possible only when the adjusted acceleration value is within a range of  $\pm 150$  Gal.



### ● Accelerometer diagnosis function

When the diagnosis operation starts, the diagnostic circuit moves the accelerometer physically. The output operation can be checked to display the results of diagnosis.

Before starting the diagnosis, check that the sensor is installed on a plane that is horizontal to  $\pm 3^\circ$  or less.

# Chapter 8. MAINTENANCE AND TROUBLESHOOTING

## **WARNING**

-  If you use the Smart Loader Package (sold separately), do so in a non-hazardous area where there is no danger of explosion or fire.
-  When there might be an explosive atmosphere, do not open the cover.
-  When discarding the battery, do not throw it into the fire. Doing so may cause it to explode.

### ■ Checklist for periodic inspection

Check the following regularly:

- The case, cover, and cable gland are not damaged.
- The cable gland and cover are not loose.
- The terminal screws are not loose.
- The O-ring attached to the cover is not damaged.
- The reference plane is level within  $\pm 3^\circ$ .

### ■ How to replace the battery

After checking that the workplace is a non-hazardous area, follow the steps below to replace the battery.

- (1) Turn OFF the power source.
- (2) Remove the cover and connect the new battery to the empty connector.
- (3) Remove the old battery and insert the new one into the battery holder.
- (4) Turn ON the power and then check that the minor failure (battery error) indication is OFF.
- (5) Put the cover back on the unit.
- (6) Using the loader, check the sensor clock time. If necessary, set the time.

### Handling Precautions

- Since the unit has no secondary battery backup function, be sure to connect a battery to the unit.
- When using the battery, strictly observe the following cautions. Failure to observe the following warnings may lead to battery overheating, rupture or leakage.
  - Do not use batteries that have a damaged surface, liquid leakage, or other abnormal condition.
  - Batteries should not be thrown into the fire, recharged, short-circuited, disassembled, or heated.
  - If possible, store batteries in a cool dry place at storage temperature.
- Always install the battery immediately before starting operation of the earthquake sensor. The battery will run down while the sensor is not turned on. Installing it prematurely might shorten its service life during actual operation.

## ■ Troubleshooting

If this unit does not work or malfunctions, check the following:

- Is the wiring loose or disconnected?
- Are the supply power and load resistance correct?
- Is faulty output being generated?

Also check the following using the loader (sold separately):

- Is the acceleration or SI value abnormal?
- Is an internal error displayed on the detailed error screen?
- Is manual output selected?

### ● Corrective actions to be taken after checking the detailed error information on the loader

Detailed error information	Description	Countermeasures
Memory error (serious failure)	Memory data or memory readout is faulty.	After checking the details of the current error, reset the power. Recorded waveform data may be deleted. If the same error occurs again, contact the azbil Group or one of its sales representatives.
A/D converter error (serious failure)	A/D converter is faulty.	After checking the details of the current error, reset the power. If the same error occurs again, contact the azbil Group or one of its sales representatives.
Sensor built-in clock error (serious failure)	Built-in clock operation is faulty.	
Vibration detection output error (serious failure)	Vibration detection output circuit is faulty.	An error has occurred in the vibration detection output circuit of the sensor. Replace the sensor with a new one.
Other hardware error (serious failure)	Other H/W error	After checking the details of the current error, reset the power. If the same error occurs again, contact the azbil Group or one of its sales representatives.
Accelerometer error (serious failure)	Accelerometer is faulty.	After checking the details of the current error, reset the power. Run the accelerometer diagnosis. If the same error occurs again, contact the azbil Group or one of its sales representatives.
Acceleration error (serious error)	Detected acceleration value is faulty.	After checking the details of the current error and sensor installation conditions, reset the power. If the same error occurs again, contact the azbil Group or one of its sales representatives.
Inclination error (serious) (serious error)	Sensor is not level.	
Acceleration noise continuous error (serious error)	Non-earthquake waveform continues abnormally.	After checking the details of the current error, reset the power. If the same error occurs again, contact the azbil Group or one of its sales representatives.
Battery level error (minor error)	Battery voltage drops.	Replace the sensor's built-in battery with a new one.  ■ How to replace the battery (P. 8-1) If the same error occurs again, contact the azbil Group or one of its sales representatives.
Temperature error (minor failure/serious failure)	Internal temperature of the sensor is abnormal.	Turn OFF the power. After checking that the ambient temperature is correct, turn ON the power again. If the same error occurs again, contact the azbil Group or one of its sales representatives.
Sensor built-in clock time error (minor failure)	Built-in clock time is incorrect.	Set the sensor built-in clock to the correct time. If the same error occurs again, contact the azbil Group or one of its sales representatives.
Inclination error (minor) (minor failure)	Sensor is not level.	After checking the details of the current error and sensor installation conditions, reset the power. If the same error occurs again, contact the azbil Group or one of its sales representatives.
Acceleration noise error (noise detection)	Non-earthquake waveform detection is faulty.	Wait for a period of time set for the noise protection continuous serious failure (initial value is 5 min). If the error is not cleared or if the same error occurs frequently, contact the azbil Group or one of its sales representatives.

# Chapter 9. DISPOSAL

When discarding this device, dispose of it properly as industrial waste, following local regulations.

 <b>WARNING</b>	
	When discarding the battery, do not throw it into the fire. Doing so may cause it to explode.

 <b>CAUTION</b>	
	Dispose of used batteries appropriately according to local regulations.

# Memo

---



# Chapter 10. SPECIFICATIONS

## 10 - 1 Specifications

	Item	Description
Basic specifications	Explosion-proof standard	Exd II BT 4 (TIIS pressure-resistant explosion-proof construction)
	Rated acceleration range	±2000 Gal (in x, y, and z directions)
	Acceleration measurement range	±2200 Gal (in x, y, and z directions)
	Acceleration measurement resolution	1 Gal (for DC acceleration measurement)
	FSG sensitivity	±2 %FSG (±980 Gal)*1 in x, y, and z directions
	FSG middle point	±3 %FSG (±980 Gal)*1 in x, y, and z directions
	Output linearity	±2 %FSO (+2000 Gal), ± 2 %FSO (–2000 Gal)*1 in x, y, and z directions
	Sensitivity in other axial directions	±3 % in x, y, and z directions
	Electrical noise	2 Gal (acceleration filter: 30 Hz) in x, y, and z directions
	Acceleration sampling	10 ms sampling
	Acceleration waveform recording	10 ms sampling for 360 s, waveforms in x, y, and z directions, 10 waveforms
Electrical specifications	Rated voltage	12 V DC ±10 % or 24 V DC ±10 %
	Current consumption	500/260 mA (12/24 V DC)
	Power ON inrush current	30 A/500 μs max.
	Contact output (vibration detection outputs 1 to 3)	Relay 1a
	Digital output 1 (minor failure detection output)	Transistor output (Nch open drain) (ON in case of a minor failure, ON/OFF action in any mode other than measurement mode)
	Digital output 2 (serious failure detection output)	Transistor output (Nch open drain) (default setting: ON in case of a serious failure)
	Digital output 3 (noise protection output)	Transistor output (Nch open drain) (default setting: ON in case of noise protection detection)
	Digital output 4 (liquefaction detection output)	Transistor output (Nch open drain) (ON in case of liquefaction detection output)
	Analog output 1 *2	4–20 mA current source (default setting: synthesized AC acceleration = 0 to 2000 Gal)
	Analog output 2 *2	4–20 mA current source (default setting: SI value = 0 to 200 kine)
	Analog output load resistance	300 Ω max.
	Digital input (diagnostic input)	Photocoupler input current source
	Dielectric Strength	500 V AC for 1 min or 600 V AC for 1 s
	Insulation Resistance	100 MΩ with 500 V DC megger
Mechanical specifications	Material	Case and cover: aluminum alloy casting
	Mounting angle	Within ±3° from horizontal
	Cable gland type	G3/4 flameproof packing
	Mass	1.9 kg
Environmental specifications	Operating temperature	Ambient temperature: –10 to +60 °C (without freezing)
	Guaranteed accuracy temperature	Ambient temperature: 0 to +50 °C (without freezing)
	Storage temperature	–20 to +70 °C
	Operating humidity	90 %RH max. (without condensation)
	Waterproofing and dust-proofing	IP67 (1 m under water for 30 min), JIS C0920 watertight (except for metal cable pipe part)*3
	Vibration resistance	19.6 m/s <sup>2</sup> max.
	Shock resistance	490 m/s <sup>2</sup> max.

**Chapter 10. SPECIFICATIONS**

Item		Description
Accessories		2 sets of flameproof packing (different types) Flameproof packing (1) and washers (2) for 10 to 12 mm outer diameter cable Flameproof packing (1) and washers (2) for 12 to 14 mm outer diameter cable Cable gland set (cable gland, cable clamp, lock nut) Battery (life: 10 years min. when power is supplied, 6 months when no power is supplied, at 20 °C) 3 hexagon socket bolts (M6×10 mm) Cross-slot head screws with captive washer (3 each of M5×30 mm and M5×20 mm) User's manual, No. CP-SP-1393E
Accessories (sold separately)		Smart Loader Package (SLP-SE7)
Replacement parts	Replacement battery	Part No.: 81446431-001 Manufacturer: Azbil Corporation Electrochemical: Manganese dioxide lithium battery Nominal voltage: 3 V Rated capacity: 240 mAh
	Maintenance parts set for SES70	Part No.: 81447670-001 Manufacturer: Azbil Corporation Includes: a cable gland and an O-ring

\*1. Measurement conditions

- Supply voltage: 12 or 24 V DC ±10 %
- Ambient temperature: 0 to 50 °C
  - Humidity: 50 ±20 %RH

\*2. SI value, synthesized AC acceleration, or JMA seismic intensity scale

\*3. Waterproofing and dust-proofing are not tested by TIIS.

## 10 - 2 Performance Specifications

Item		Description
PV*1	Synthesized AC acceleration measurement range	0 to 4000 Gal
	SI measurement range	0 to 300 kine
	Measurement range of JMA seismic intensity scale equivalent value	0 to 7.9
Analog output*2	Output type	4–20 mA current source DC output, without isolation
	D/A conversion method	Conversion by PWM, period = 2.05 ms (488 Hz)
	Allowable load resistance	300 Ω max.
	Output accuracy	±0.2 %FS (0 to 50 °C)
	Output resolution	14 bits
	Open terminal voltage	26.4 V DC max.
	Max. output current	21.6 mA
	Min. output current	2.4 mA DC
	Output update cycle	10 ms
	Output response time	150 ms
Output hold	The maximum value is held for the preset peak hold time. (The hold time can be set using the loader. Initial value: 20 s)	
Vibration detection output (relay)*3	No. of relays	3
	Contact arrangement	1a contact relay output
	Contact rating	30 V DC, 0.5 A max., resistive load (a 100 V AC line cannot be connected)
	Vibration detection setting	The vibration detection threshold can be set to SI value, synthesized AC acceleration, or JMA seismic intensity scale equivalent value
	Vibration detection conditions	It is possible to make combinations with AND and OR of four conditions: SI value, synthesized AC acceleration, JMA seismic intensity scale equivalent value, and liquefaction. (Default: None of the four items or AND or OR conditions are enabled for vibration detection judgments 1, 2, or 3.)
	Default setting	The maximum possible values are as follows: SI value: 300 kine Synthesized acceleration: 4000 Gal JMA seismic intensity scale equivalent value: 7.9
	Output hold	ON output is held for the preset hold time. (The hold time can be set using the loader. Initial value is 20 s.)
Open collector outputs (DO1 to 4)*4	Output type	Transistor output (Nch open drain)
	Dielectric strength of output	30 V DC
	Max. output current	50 mA DC
	OFF-state leakage current	100 μA DC max.
	ON residual voltage	0.5 V DC max.
Output short-circuit protection	Built-in protective circuit	
Digital input (DI1)*5	Compatible output types	Non-voltage contacts (relay, mechanical switch), open collector
	Internal circuit type	Photocoupler diode input, current source
	Open terminal voltage	The maximum voltage between the ground and input terminals is the supply voltage to the unit.
	Terminal current (when shorted)	9 mA DC max.
	Allowable contact resistance	ON conditions: 500 Ω max., OFF conditions: 2000 kΩ min.
	ON residual voltage	5.5 V DC max.
Built-in clock time*6	Accuracy	Monthly error ±120 s (at 20 °C)

\*1. PV is obtained from calculation based on the measured acceleration in x, y, and z directions, and is used for vibration detection output, analog output, and waveform recording conditions.  ■ Various calculations and judgment processes (P. 6-8)

\*2. It is possible to output the SI value, synthesized AC acceleration, and JMA seismic intensity scale equivalent value from the 2-channel analog current output.

\*3. If the vibration detection output exceeds the vibration detection conditions, the relay contact, which is the vibration detection output, turns ON.

\*4. If liquefaction is detected or if any serious failure or minor failure occurs, each DO output turns ON.

\*5. This input can be used as a mode transition request input for maintenance mode or standby mode.

\*6. The clock time is used for time stamps during waveform recording. The time can be adjusted using the loader. The clock IC is backed up by the battery.

## 10 - 3 Other Specifications

### ■ Communication specifications

Item		Description
Loader specifications	Connection	The dedicated cable is connected to the loader jack.
	Communication system	TTL level half-duplex 3-wire system
	Baud rate	115200 bps
Communication	Communication method	3-wire RS-485, half-duplex
	Communication switchover	When the loader cable is connected, RS-485 is capable of reading data only.
	Baud rate	38400 bps
	Cable length	500 m max. (total length of all wiring)*

\*As extension cabling for all wiring, use shielded twisted pair wires.

### ! Handling Precautions

- For wiring for RS-485, do not connect an external terminating resistor. If a terminating resistor is connected to either end of the transmission line, communication is not possible.
- This device does not incorporate any countermeasures against lightning. If there is a risk of power surge due to lightning, take protective measures.  
 ■ Lightning surge protection (P. 4-6)

### ■ External dimensions

Unit: mm

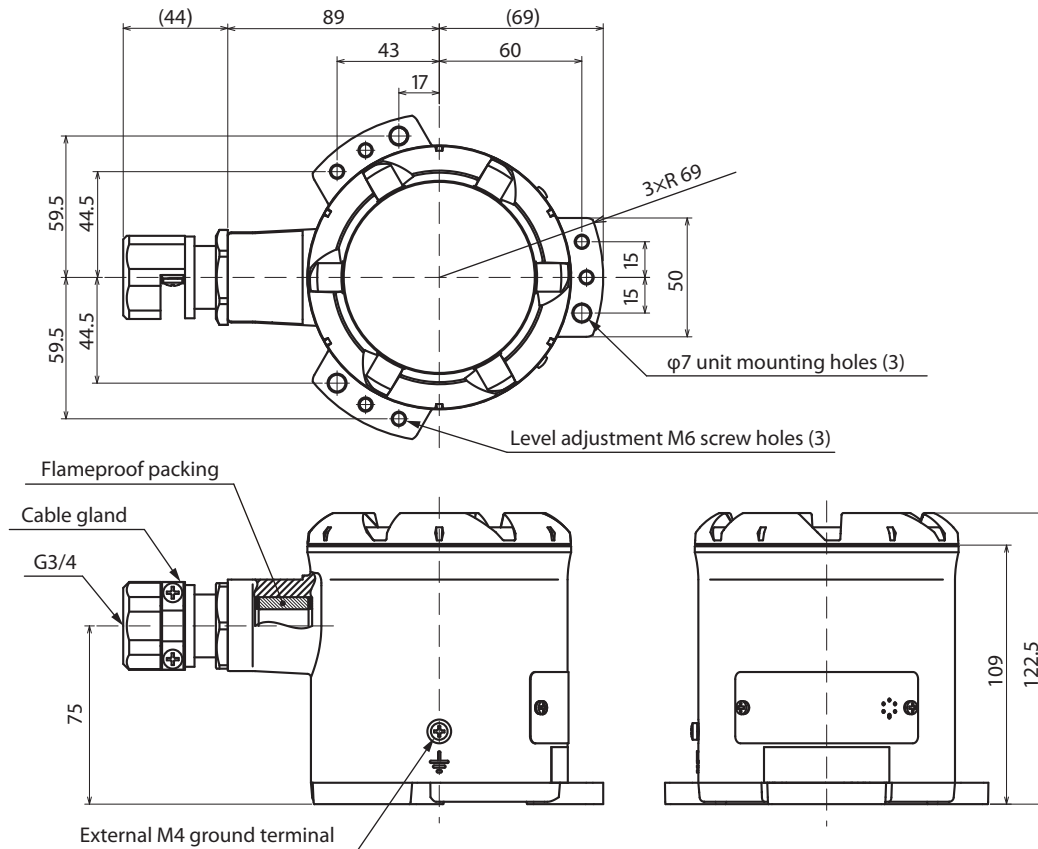

# APPENDIX

## ■ Glossary

Term	Description	Related sections	Page
Accelerometer	The acceleration detection element that is built into this unit. The accelerometer can detect acceleration on the X-, Y-, and Z-axes.	NAMES AND FUNCTIONS OF PARTS Performance Specifications	P. 2-1 P. 10-3
SI value	A numeric value correlated with earthquake damage. The unit is kine (= cm/s). The value that is actually read out or output is the maximum value that is obtained during a period of 10 to 20 seconds. SI1: SI calculation in 8 directions, with 7 natural periods SI2: SI calculation in 16 directions, with 24 natural periods	SI calculation Vibration detection and liquefaction judgment functions Output functions	P. 6-10 P. 6-22 P. 6-29
Synthesized AC acceleration	Horizontal plane 2-axis or 3-axis vector synthesized AC acceleration. The unit is Gal (= cm/s <sup>2</sup> ). The value that is actually read out or output is the maximum value that is obtained during a period of 10 to 20 seconds.	Synthesized AC acceleration calculation Vibration detection and liquefaction judgment functions Output functions	P. 6-11 P. 6-22 P. 6-29
JMA seismic intensity scale equivalent value	A damage estimate value calculated from correlation equations using either the SI value only or the SI value and the synthesized AC acceleration.	Calculation of the JMA seismic intensity scale equivalent value	P. 6-12
Characterization compensation	Offsetting the temperature characteristics of the accelerometer using measurements from the temperature sensor, in order to improve the accuracy of the measured acceleration	Internal calculation processes	P. 6-7
Acceleration for calculation	An acceleration value that has the frequency band necessary to calculate the SI value and JMA seismic intensity scale equivalent value. This acceleration is also used for the waveform recording and synthesized AC acceleration PV.	Internal calculation processes Waveform recording	P. 6-7 P. 6-13
Acceleration for control	An acceleration value whose high-frequency area is eliminated when compared to the acceleration for calculation, in order to reduce background noise for purposes of AO and monitoring.	Internal calculation processes	P. 6-7
Adjusted acceleration value	Acceleration value after completion of bias adjustment	Internal calculation processes Real-time data monitoring	P. 6-7 P. 7-1
Inclination acceleration	This value shows static acceleration due to temperature drift and inclination of the place of installation.	Internal calculation processes Real-time data monitoring	P. 6-7 P. 7-1
AC acceleration	This is dynamic acceleration (= adjusted acceleration - inclination acceleration)	Internal calculation processes Real-time data monitoring	P. 6-7 P. 7-1
Vibration detection judgment	If the SI value and synthesized acceleration value exceed the preset values and the output conditions are satisfied, the unit enters the vibration detection state (i.e., vibration was detected).	Vibration detection judgment function	P. 6-22
Vibration detection output	If the vibration detection judgment conditions are satisfied and no errors are detected, the vibration detection output relay turns ON.	Vibration judgment function Output functions	P. 6-22 P. 6-29
Liquefaction judgment	If the liquefaction judgment conditions, such as SI value, synthesized acceleration value, estimated displacement, and zero-cross count are satisfied, the unit enters the liquefaction detection state (i.e., liquefaction was detected).	Liquefaction judgment function Output functions	P. 6-22 P. 6-29
Liquefaction detection output	If the liquefaction judgment conditions are satisfied and no errors are detected, the liquefaction output (DO4) turns ON.	Liquefaction judgment function Output functions	P. 6-22 P. 6-29
Waveform recording	Two kinds of waveform recording functions are provided: automatic waveform recording (10 waveforms) and forced waveform recording (1 waveform).	Waveform recording	P. 6-13
Error diagnosis	Four types of error are detected: reset, serious failure, minor failure, and noise detection.	Error diagnosis functions	P. 6-26
Reset	If a serious failure that affects all functions occurs, the unit is reset.	Error diagnosis functions	P. 6-26
Minor failure	This failure does not affect control output, but a check should be made for waveform record errors, errors in time records, and erroneous clock time. The installation conditions should also be checked. The minor failure output turns ON.	Error diagnosis functions LED output function	P. 6-26 P. 6-36

Term	Description	Related sections	Page
Serious failure	This failure may affect control output such as vibration detection output and liquefaction detection output. The serious failure output turns ON and the control output turns OFF.	Error diagnosis functions LED output function	P. 6-26 P. 6-36
Noise detection & noise protection	A signal other than the vibration waveform is detected. This failure may affect the results of calculation. Various PVs are set to 0 or turned OFF. The minor failure output flashes.	Noise protection function Error diagnosis functions LED output function	P. 6-24 P. 6-26 P. 6-36
Maintenance sequence	A fixed sequence of output changes in maintenance mode, allowing device operation and instrumentation to be checked on a connected external device.	Maintenance sequence	P. 6-34
Accelerometer diagnosis	A diagnostic circuit physically moves the accelerometer to check for operational errors.	Error diagnosis functions Maintenance sequence	P. 6-26 P. 6-34
Auto bias	Automatic adjustment of the bias, initiated using the loader.	Acceleration calculation process Diagnosis and adjustment function	P. 6-7 P. 7-8
FSG	The 1960 Gal span that is the guaranteed accuracy acceleration range (gravity acceleration reference $\pm 980$ Gal)	Specifications	P. 10-1
% FSG	Percentage of the 1960 Gal span ( $\pm 2\%$ FSG = $\pm 39.2$ Gal)	Specifications	P. 10-1
FSO	The 4000 Gal span that is the measurable acceleration range ( $\pm 2000$ Gal)	Specifications	P. 10-1
% FSO	Percentage of the 4000 Gal span	Specifications	P. 10-1

**Method of determining acceleration accuracy**

The method of measuring static acceleration, such as by FSG sensitivity and FSG middle point using the gravity of the earth, is described below.

Note that the acceleration measurement axes described in Chapter 2, "NAMES AND FUNCTIONS OF PARTS," are the dynamic acceleration directions due to vibration, which are opposite to those of the static acceleration axes.

Chapter 2. NAMES AND FUNCTIONS OF PARTS

**X-axis FSG measurement**

(1) Position this unit as shown in figure 1A.

Expected acceleration adjustment (Gal)		
X-axis ( $\alpha X_{-980}$ )	Y-axis	Z-axis
-980	0	980

Measure the "-980 Gal" output of the X-axis ( $\alpha X_{-980}$ ).

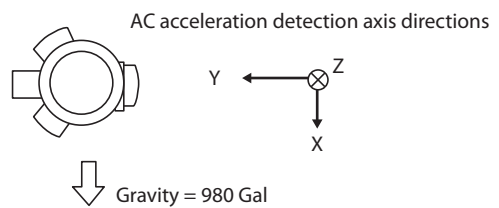

Figure 1A: X-axis FSG measurement ( $\alpha X_{-980}$ )

(2) Position this unit as shown in figure 1B.

Expected acceleration adjustment (Gal)		
X-axis ( $\alpha X_{+980}$ )	Y-axis	Z-axis
980	0	980

Measure the "+980 Gal" output of the X-axis ( $\alpha X_{+980}$ ).

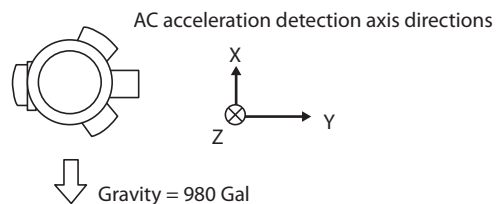

Figure 1B: X-axis FSG measurement ( $\alpha X_{+980}$ )

(3) Measure the X-axis FSG sensitivity.

$$\alpha X_{FSG} = \alpha X_{+980} - \alpha X_{-980}$$

The following accuracy standards apply to the FSG sensitivity calculated from the above expression:

$$\text{FSG sensitivity } \pm 2 \% \text{ FSG } (1960 \text{ Gal} - 39.2 \text{ Gal} \leq \alpha X_{FSG} \leq 1960 \text{ Gal} + 39.2 \text{ Gal})$$

(4) Measure the X-axis FSG middle point.

$$\alpha X_{FSG - \text{mid}} = \frac{\alpha X_{+980} + \alpha X_{-980}}{2}$$

The following accuracy standards apply to the FSG middle point calculated from the above expression:

$$\text{FSG middle point } \pm 3 \% \text{ FSG } (-58.8 \text{ Gal} \leq \alpha X_{FSG - \text{mid}} \leq 58.8 \text{ Gal})$$

● **Y-axis FSG measurement**

(1) Position this unit as shown in figure 2A.

Expected acceleration adjustment (Gal)		
X-axis	Y-axis ( $\alpha Y_{-980}$ )	Z-axis
0	-980	980

Measure the "-980 Gal" output of the Y-axis ( $\alpha Y_{-980}$ ).

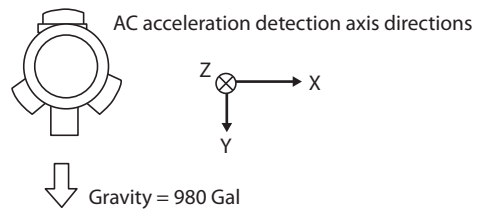

Figure 2A: Y-axis FSG measurement ( $\alpha Y_{-980}$ )

(2) Position this unit as shown in figure 2B.

Expected acceleration adjustment (Gal)		
X-axis	Y-axis ( $\alpha Y_{+980}$ )	Z-axis
0	980	980

Measure the "+980 Gal" output of the Y-axis ( $\alpha Y_{+980}$ ).

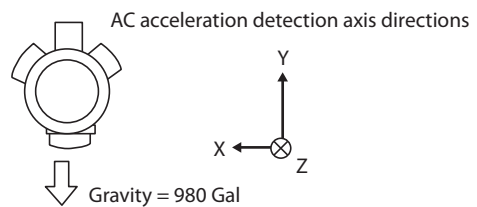

Figure 2B: Y-axis FSG measurement ( $\alpha Y_{+980}$ )

(3) Measure the Y-axis FSG sensitivity.

$$\alpha Y_{FSG} = \alpha Y_{+980} - \alpha Y_{-980}$$

The following accuracy standards apply to the FSG sensitivity calculated from the above expression:

$$\text{FSG sensitivity } \pm 2 \% \text{ FSG } (1960 \text{ Gal} - 39.2 \text{ Gal} \leq \alpha Y_{FSG} \leq 1960 \text{ Gal} + 39.2 \text{ Gal})$$

(4) Measure the Y-axis FSG middle point.

$$\alpha Y_{FSG - \text{mid}} = \frac{\alpha Y_{+980} + \alpha Y_{-980}}{2}$$

The following accuracy standards apply to the FSG middle point calculated from the above expression:

$$\text{FSG middle point } \pm 3 \% \text{ FSG } (-58.8 \text{ Gal} \leq \alpha Y_{FSG - \text{mid}} \leq 58.8 \text{ Gal})$$

● Z-axis FSG measurement

(1) Position this unit as shown in figure 3A.

Expected acceleration adjustment (Gal)		
X-axis	Y-axis	Z-axis ( $\alpha Z_0$ )
0	0	0

Measure the "0 Gal" output of the Z-axis ( $\alpha Z_0$ )

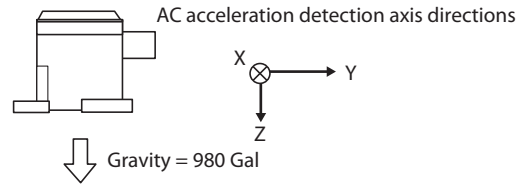

Figure 3A: Z-axis FSG measurement ( $\alpha Z_0$ )

(2) Position this unit as shown in figure 3B.

Expected acceleration adjustment (Gal)		
X-axis	Y-axis	Z-axis ( $\alpha Z_{+1960}$ )
0	0	1960

Measure the "1960 Gal" output of the Z-axis ( $\alpha Z_{+1960}$ ).

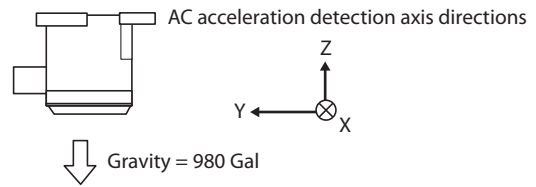

Figure 3B: Z-axis FSG measurement ( $\alpha Z_{+1960}$ )

(3) Measure the Z-axis FSG sensitivity.

$$\alpha Z_{FSG} = \alpha Z_{+1960} - \alpha Z_0$$

The following accuracy standards apply to the FSG sensitivity calculated from the above expression:

$$\text{FSG sensitivity } \pm 2 \% \text{ FSG } (1960 \text{ Gal} - 39.2 \text{ Gal} \leq \alpha Z_{FSG} \leq 1960 \text{ Gal} + 39.2 \text{ Gal})$$

(4) Measure the Z-axis FSG middle point.

$$\alpha Z_{FSG\text{-mid}} = \frac{\alpha Z_{+1960} + \alpha Z_0}{2}$$

The following accuracy standards apply to the FSG middle point calculated from the above expression:

$$\text{FSG middle point } \pm 3 \% \text{ FSG } (980 - 58.8 \text{ Gal} \leq \alpha Z_{FSG\text{-mid}} \leq 980 + 58.8 \text{ Gal})$$

● Example of measurement equipment (Azbil Corporation's inspection equipment)

Azbil Corporation uses static acceleration generation equipment with orthogonalized turntables on two axes with a horizontal plane adjustment function for accuracy inspection.

The angles of turntables 1 and 2 are adjusted to "0°" and the foot lengths of the equipment are adjusted to level turntable 2.

To generate acceleration, static acceleration is output based on the angle of rotation of each turntable.

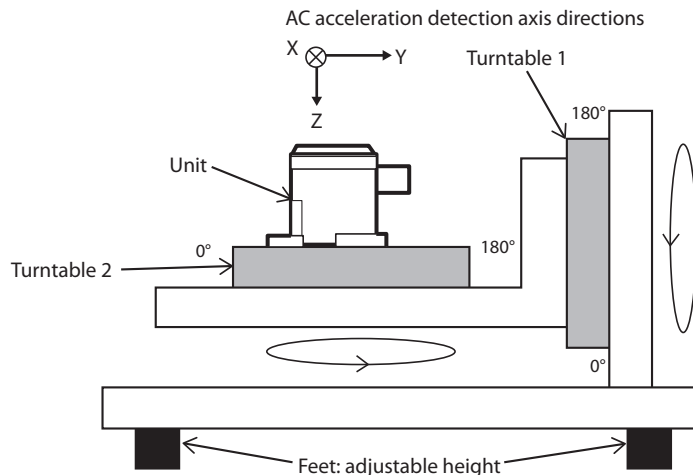



## ■ Relationships between JMA seismic intensity, acceleration, SI value, and measured JMA seismic intensity

Previous JMA seismic intensity level		New JMA seismic intensity level			Application of JMA seismic intensity scale equivalent value
JMA seismic intensity	Acceleration (Gal) (A)	JMA seismic intensity	Measured JMA seismic intensity (M)	SI value (kine) (SI)	
0	$A < 0.8$	0	$M < 0.5$	-	×
1	$0.8 \leq A < 2.5$	1	$0.5 \leq M < 1.5$	-	×
2	$2.5 \leq A < 8.0$	2	$1.5 \leq M < 2.5$	-	◆
3	$8.0 \leq A < 25.0$	3	$2.5 \leq M < 3.5$	$1.1 \leq SI < 3.8$	○
4	$25.0 \leq A < 80.0$	4	$3.5 \leq M < 4.5$	$3.8 \leq SI < 12.6$	○
5	$80.0 \leq A < 250.0$	5-	$4.5 \leq M < 5.0$	$12.6 \leq SI < 22.9$	○
		5+	$5.0 \leq M < 5.5$	$22.9 \leq SI < 41.7$	○
6	$250.0 \leq A < 400.0$	6-	$5.5 \leq M < 6.0$	$41.7 \leq SI < 75.9$	○
		6+	$6.0 \leq M < 6.5$	$75.9 \leq SI < 138.2$	○
7	$400.0 \leq A$	7	$6.5 \leq M$	$138.2 \leq SI$	○

The JMA seismic intensity scale equivalent value can be regarded as the measured JMA seismic intensity.

The JMA seismic intensity scale equivalent value is obtained using expression 2.

☞ ■ Calculation of the JMA seismic intensity scale equivalent value (P. 6-12)

○: Applicable

◆: Error may be large depending on the waveform.

×: Not applicable due to a large amount of error.

### ! Handling Precautions

- The relationship between the JMA seismic intensity and acceleration value stated in the above table should be used only as a rough estimate. In particular, since the effect of the high-frequency component of acceleration on the actual damage is small, the error in the case of an acceleration waveform with a large high-frequency component will be large.

# Memo

---

# Revision History (CP-SP-1376E)

Printed	Edn.	Revised pages	Description
<b>Apr. 2015</b>	<b>1</b>		
<b>Mar. 2017</b>	<b>2</b>	6-32 10-2 10-3, 10-4 End of the manual	Table of “ ■ Output selection” changed. Maintenance parts set for SES70 was added. Old page 10-2 to 10-3 Terms and Conditions were changed (to version No. AA511A-014-09).

# Terms and Conditions

We would like to express our appreciation for your purchase and use of Azbil Corporation's products. You are required to acknowledge and agree upon the following terms and conditions for your purchase of Azbil Corporation's products (system products, field instruments, control valves, and control products), unless otherwise stated in any separate document, including, without limitation, estimation sheets, written agreements, catalogs, specifications and instruction manuals.

## 1. Warranty period and warranty scope

### 1.1 Warranty period

Azbil Corporation's products shall be warranted for one (1) year from the date of your purchase of the said products or the delivery of the said products to a place designated by you.

### 1.2 Warranty scope

In the event that Azbil Corporation's product has any failure attributable to azbil during the aforementioned warranty period, Azbil Corporation shall, without charge, deliver a replacement for the said product to the place where you purchased, or repair the said product and deliver it to the aforementioned place.

Notwithstanding the foregoing, any failure falling under one of the following shall not be covered under this warranty:

- (1) Failure caused by your improper use of azbil product (noncompliance with conditions, environment of use, precautions, etc. set forth in catalogs, specifications, instruction manuals, etc.);
- (2) Failure caused for other reasons than Azbil Corporation's product;
- (3) Failure caused by any modification or repair made by any person other than Azbil Corporation or Azbil Corporation's subcontractors;
- (4) Failure caused by your use of Azbil Corporation's product in a manner not conforming to the intended usage of that product;
- (5) Failure that the state-of-the-art at the time of Azbil Corporation's shipment did not allow Azbil Corporation to predict; or
- (6) Failure that arose from any reason not attributable to Azbil Corporation, including, without limitation, acts of God, disasters, and actions taken by a third party.

Please note that the term "warranty" as used herein refers to equipment-only-warranty, and Azbil Corporation shall not be liable for any damages, including direct, indirect, special, incidental or consequential damages in connection with or arising out of Azbil Corporation's products.

## 2. Ascertainment of suitability

You are required to ascertain the suitability of Azbil Corporation's product in case of your use of the same with your machinery, equipment, etc. (hereinafter referred to as "Equipment") on your own responsibility, taking the following matters into consideration:

- (1) Regulations and standards or laws that your Equipment is to comply with.
- (2) Examples of application described in any documents provided by Azbil Corporation are for your reference purpose only, and you are required to check the functions and safety of your Equipment prior to your use.
- (3) Measures to be taken to secure the required level of the reliability and safety of your Equipment in your use

Although azbil is constantly making efforts to improve the quality and reliability of Azbil Corporation's products, there exists a possibility that parts and machinery may break down.

You are required to provide your Equipment with safety design such as fool-proof design, \*1 and fail-safe design\*2 (anti-flame propagation design, etc.), whereby preventing any occurrence of physical injuries, fires, significant damage, and so forth. Furthermore, fault avoidance,\*3 fault tolerance,\*4 or the like should be incorporated so that the said Equipment can satisfy the level of reliability and safety required for your use.

\*1. A design that is safe even if the user makes an error.

\*2. A design that is safe even if the device fails.

\*3. Avoidance of device failure by using highly reliable components, etc.

\*4. The use of redundancy.

## 3. Precautions and restrictions on application

Azbil Corporation's products other than those explicitly specified as applicable (e.g. azbil Limit Switch For Nuclear Energy) shall not be used in a nuclear energy controlled area (radiation controlled area).

Any Azbil Corporation's products shall not be used for/with medical equipment.

The products are for industrial use. Do not allow general consumers to install or use any Azbil Corporation's product.

However, azbil products can be incorporated into products used by general consumers. If you intend to use a product for that purpose, please contact one of our sales representatives.

In addition,

you are required to conduct a consultation with our sales representative and understand detail specifications, cautions for operation, and so forth by reference to catalogs, specifications, instruction manual, etc. in case that you intend to use azbil product for any purposes specified in (1) through (6) below.

Moreover, you are required to provide your Equipment with fool-proof design, fail-safe design, anti-flame propagation design, fault avoidance, fault tolerance, and other kinds of protection/safety circuit design on your own responsibility to ensure reliability and safety, whereby preventing problems caused by failure or nonconformity.

- (1) For use under such conditions or in such environments as not stated in technical documents, including catalogs, specification, and instruction manuals
- (2) For use of specific purposes, such as:
  - \* Nuclear energy/radiation related facilities  
[For use outside nuclear energy controlled areas] [For use of Azbil Corporation's Limit Switch For Nuclear Energy]
  - \* Machinery or equipment for space/sea bottom
  - \* Transportation equipment  
[Railway, aircraft, vessels, vehicle equipment, etc.]
  - \* Antidisaster/crime-prevention equipment

- \* Burning appliances
  - \* Electrothermal equipment
  - \* Amusement facilities
  - \* Facilities/applications associated directly with billing
- (3) Supply systems such as electricity/gas/water supply systems, large-scale communication systems, and traffic/air traffic control systems requiring high reliability
  - (4) Facilities that are to comply with regulations of governmental/public agencies or specific industries
  - (5) Machinery or equipment that may affect human lives, human bodies or properties
  - (6) Other machinery or equipment equivalent to those set forth in items (1) to (5) above which require high reliability and safety
4. Precautions against long-term use
 

Use of Azbil Corporation's products, including switches, which contain electronic components, over a prolonged period may degrade insulation or increase contact-resistance and may result in heat generation or any other similar problem causing such product or switch to develop safety hazards such as smoking, ignition, and electrification. Although acceleration of the above situation varies depending on the conditions or environment of use of the products, you are required not to use any Azbil Corporation's products for a period exceeding ten (10) years unless otherwise stated in specifications or instruction manuals.
  5. Recommendation for renewal
 

Mechanical components, such as relays and switches, used for Azbil Corporation's products will reach the end of their life due to wear by repetitious open/close operations. In addition, electronic components such as electrolytic capacitors will reach the end of their life due to aged deterioration based on the conditions or environment in which such electronic components are used. Although acceleration of the above situation varies depending on the conditions or environment of use, the number of open/close operations of relays, etc. as prescribed in specifications or instruction manuals, or depending on the design margin of your machine or equipment, you are required to renew any Azbil Corporation's products every 5 to 10 years unless otherwise specified in specifications or instruction manuals. System products, field instruments (sensors such as pressure/flow/level sensors, regulating valves, etc.) will reach the end of their life due to aged deterioration of parts. For those parts that will reach the end of their life due to aged deterioration, recommended replacement cycles are prescribed. You are required to replace parts based on such recommended replacement cycles.
  6. Other precautions
 

Prior to your use of Azbil Corporation's products, you are required to understand and comply with specifications (e.g., conditions and environment of use), precautions, warnings/cautions/notices as set forth in the technical documents prepared for individual Azbil Corporation's products, such as catalogs, specifications, and instruction manuals to ensure the quality, reliability, and safety of those products.
  7. Changes to specifications
 

Please note that the descriptions contained in any documents provided by azbil are subject to change without notice for improvement or for any other reason. For inquires or information on specifications as you may need to check, please contact our branch offices or sales offices, or your local sales agents.
  8. Discontinuance of the supply of products/parts
 

Please note that the production of any Azbil Corporation's product may be discontinued without notice. For repairable products, we will, in principle, undertake repairs for five (5) years after the discontinuance of those products. In some cases, however, we cannot undertake such repairs for reasons, such as the absence of repair parts. For system products, field instruments, we may not be able to undertake parts replacement for similar reasons.
  9. Scope of services
 

Prices of Azbil Corporation's products do not include any charges for services such as engineer dispatch service. Accordingly, a separate fee will be charged in any of the following cases:

    - (1) Installation, adjustment, guidance, and attendance at a test run
    - (2) Maintenance, inspection, adjustment, and repair
    - (3) Technical guidance and technical education
    - (4) Special test or special inspection of a product under the conditions specified by you

Please note that we cannot provide any services as set forth above in a nuclear energy controlled area (radiation controlled area) or at a place where the level of exposure to radiation is equivalent to that in a nuclear energy controlled area.



*Specifications are subject to change without notice.* (09)

---

**Azbil Corporation**  
Advanced Automation Company

1-12-2 Kawana, Fujisawa  
Kanagawa 251-8522 Japan

URL: <http://www.azbil.com>

1st edition: Apr. 2015 (V)  
2nd edition: Mar. 2017 (F)