

Multichannel, multifunction Transmitter/Controller

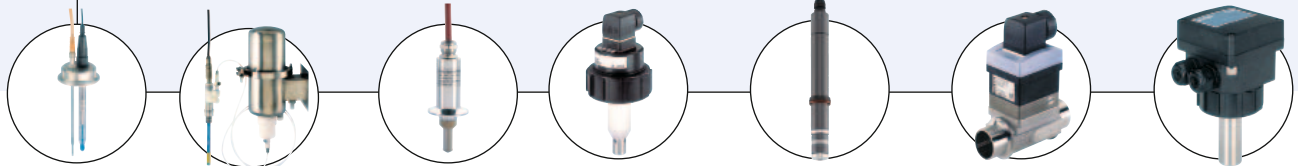

- Compatible with most common flow, pH/ORP, chlorine and conductivity sensors
- Simple, intuitive user interface supported by a large adjustable backlit display (4 user defined views)
- Basic transmitter/controller with hardware extension possibilities (up to 6 free slots)
- Functionality extendable by software options

Type 8619 can be combined with...



Type 8200+8203

pH/ORP sensor

Type 8201

pH system

Type 8221

Conductivity sensors
4-pole technology

Type 8220

Conductivity sensors
2-pole technology

Type 8232

Chlorine sensor

Type 8030

INLINE
flowmeter

Type 8041

Electromagnetic
flowmeter

The 8619 multichannel multifunction, available in two housing variants for panel or wall mounting, is a microprocessor transmitter/controller for connection of sensors which deliver raw signals for pH, ORP, conductivity and flow via pulses or sensors (like pressure, level, chlorine...) which delivers analogue signals: 0...20 mA, 4...20 mA, 0...2 V, 0...5 V, 0...10 V.

Type 8619 is the ideal device for measurement and control and as well dosing processes e.g. in applications of water treatment plants (like boiler, cooling tower or reverse osmosis systems) and food and pharma plants. Modularity in hardware and software offers high flexibility for adjusting it to the applications resulting in having a very good price to functionality relation.

Sophisticated electronics and state of the art control algorithms ensure that optimum process control is maintained at all times with minimal operator intervention and achieving highest quality.

Technical data	
General data	
Mounting	Panel-mounted (standardized 1/4 DIN housing for 92 x 92 mm cutout) Wall-mounted (with mounting plate)
Materials	<p>Seal / Screws: Silicone / Stainless steel 316</p> <p>Support plate for terminals: Stainless steel 304</p> <p>Terminal blocks: PBT, contact in gold-plated copper alloy</p> <p>Display / Front panel and keys: PC / Silicone</p> <p>Housing:</p> <ul style="list-style-type: none"> Panel-mounted: PPO (incl. fastening element) Wall-mounted: PA66 (incl. fastening plate, cable gland, protecting cover (display), protecting cap (free terminal place), stiffener hinge) <p>Protective cap (110...240 V AC supplied wall-mounted version): Stainless steel 304</p> <p>Cover screws (wall-mounted version): PVC</p>
Display	LC graphic display, light blue backlighted; 128 x 168 pixels resolution; German, English, French languages
Keypad	4 soft keys [F1] [F2] [F3] [F4] for dynamic functions 1 central navigation key with [↑] [↓] [→] [←] assignments
Data logger	up to 16 values
Sensor monitor	Direct display and verification of measured sensor values
Clock	Real-time clock with date
Board slots	6
Electrical connection	Terminal blocks
Recommended cable	Cable with max. operating temperature of min. 90°C
Solid H05(07) V-U	0.2...1.5 mm ² , shielded cable
Flexible H05(07) V-K	0.2...1.5 mm ² , shielded cable
With wire end ferrule	0.2...1.5 mm ² , shielded cable
With plastic collar ferrule	0.2...1.5 mm ² , shielded cable

Electrical data		
Device version	Panel-mounted - Mainboard	Wall-mounted - Power supply board
Operating voltage ("SUPPLY")	12...30 V DC, $\pm 10\%$, max. 2 A, filtered and regulated, SELV (safety extra low voltage) circuit with a non dangerous energy level	<ul style="list-style-type: none"> 12...36 V DC $\pm 10\%$, max. 2 A, filtered and regulated, SELV (safety extra low voltage) circuit with a non dangerous energy level 110...240 V AC, 50...60 Hz, max. 500 mA, integrated protection: 3.15 A time delay fuse ground cable cross-section: 1.5 mm²
Power consumption (of multiCELL device - without additional boards and outputs not connected)	Max. 1.5 VA	Max. 2 VA
Power charges ("PWR OUT" or "POWER OUT" acc. to version)	12...30 V DC, max 1.8 A protected against polarity reversals	<ul style="list-style-type: none"> 12...36 V DC version: 12...36 V DC, max 1.8 A; protected against polarity reversals 110...240 V AC version: 24 V DC $\pm 2\%$, filtered and regulated, SELV (safety extra low voltage) circuit with a non dangerous energy level, max 1.2 A protected against polarity reversals The allowed max. current depends on the ambient temperature: see diagram below
Device version	Panel-mounted - Mainboard	Wall-mounted - Mainboard
Digital inputs DI1, DI2	Voltage: 0...36 V DC, input impedance 3 k Ω Switching threshold : $V_{on} = 5...36$ V DC, $V_{off} < 2$ V DC; Frequency: 0.5...2500 Hz Galvanic insulation, protected against reversed polarity of DC and voltage spikes	Voltage: 0...36 V DC, input impedance 3 k Ω Switching threshold : $V_{on} = 5...36$ V DC, $V_{off} < 2$ V DC; Frequency: 0.5...2500 Hz Galvanic insulation, protected against reversed polarity of DC and voltage spikes
Digital outputs DO1, DO2	Transistor: can be wired as PNP or NPN, galvanic insulation, protected against short circuit, max. 36 V DC, max. 700 mA per transistor output, 1 A max. in total if both transistor outputs are used; Operating modes: On/Off, Hysteresis, Window, PWM, PFM, Pulse; Frequency: max. 2000 Hz	Transistor: can be wired as PNP or NPN, galvanic insulation, protected against short circuit, max. 36 V DC, max. 700 mA per transistor output, 1 A max. in total if both transistor outputs are used; Operating modes: On/Off, Hysteresis, Window, PWM, PFM, Pulse; Frequency: max. 2000 Hz
Analogue output AO1, AO2	4...20 mA, can be wired as sourcing or sinking, galvanic insulation, protected against reversed polarity of DC, max. loop impedance: 860 Ω at 30 V DC, 610 Ω at 24 V DC, 100 Ω at 12 V DC Resolution: 6 μ A	4...20 mA, can be wired as sourcing or sinking, galvanic insulation, protected against reversed polarity of DC, max. loop impedance: 1100 Ω at 36 V DC, 610 Ω at 24 V DC, 100 Ω at 12 V DC Resolution: 6 μ A
Memory card Type / Capacity	SD (Secure Digital) or SDHC (Secure Digital High Capacity) / max. 8 GB Note: We recommend to use the 8 GB SDHC memory card available at Bürkert (see accessories on page 12) because it has been tested with and validated for the 8619 Transmitter/Controller. Another memory card may not operate correctly.	



If the device is mounted in a humid environment or outside the maximum allowed voltages are **35 V DC** instead of 36 V DC.

Max. allowed current in dependence of the ambient temperature (for wall-mounted version, 110...240 V AC)

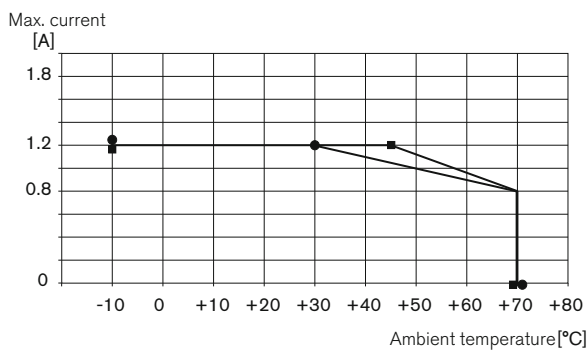

■ Wall-mounted version, 110...240 V AC, without extension board
● Wall-mounted version, 110...240 V AC, with extension boards

For UL certified device

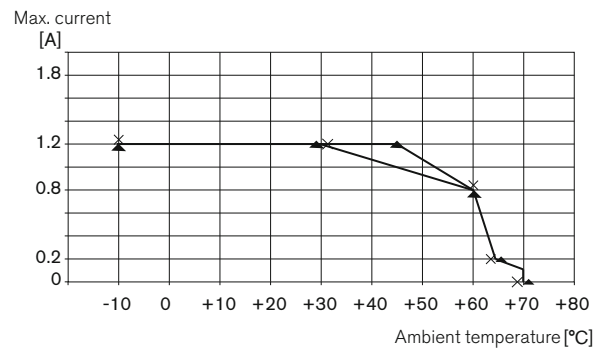

✕ Wall-mounted version, 110...240 V AC, without extension board
▲ Wall-mounted version, 110...240 V AC, with extension boards

Materials view

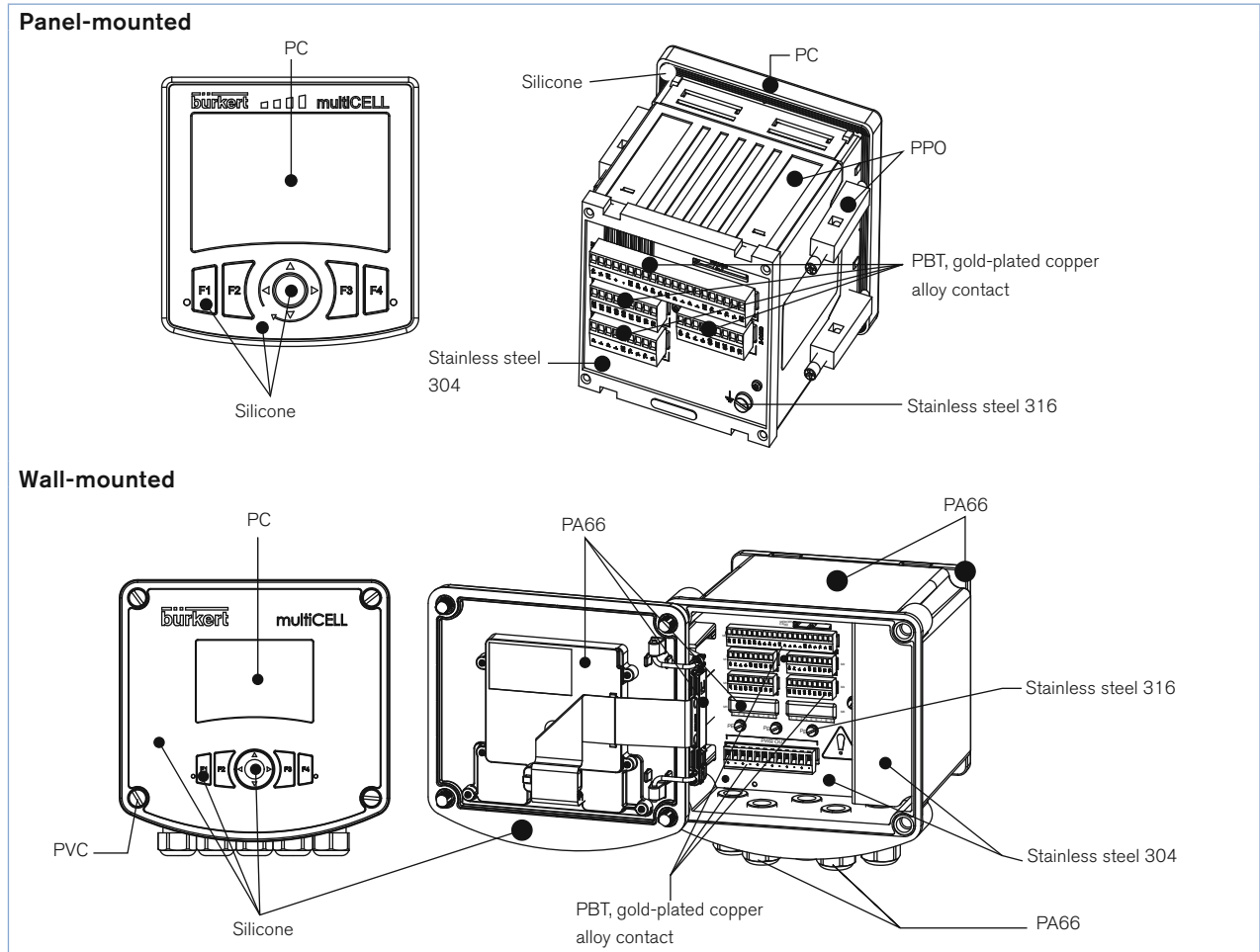

Additional boards

- 4 different types of boards are available and can be inserted into any of the 6 slots (preconfigured at the factory)
- input board: 2 analogue inputs (4...20 mA or 0...20 mA or 0...2 V or 0...5 V or 0...10 V) and 2 digital inputs (static or frequency/puls)
 - output board: 2 transistor outputs and 2 analogue 4...20 mA outputs
 - input pH/ORP and Pt100/Pt1000 boards
 - input conductivity and Pt100/Pt1000 boards

Technical data - input board	
Power consumption	0.1 VA
Analogue inputs AI1, AI2	can be wired as sourcing or sinking, galvanic insulation
Current	range: 0 or 3.5...22 mA max. voltage: 36 V DC impedance: 50 Ω resolution: 1.5 μA
Voltage	range: 0...2 or 5 or 10 V DC max. voltage: 36 V DC impedance: 110 kΩ resolution: 1 mV
Error	±0.25% of measured value
Digital inputs DI1, DI2	Voltage: 0...36 V DC, input impedance 3 kΩ Switching threshold : $V_{on} = 5...36$ V DC, $V_{off} < 2$ V DC; Frequency: 0.5...2500 Hz Galvanic insulation, protected against reversed polarity of DC and voltage spikes

Technical data - output board	
Power consumption	Max. 0.1 VA
Digital outputs DO1, DO2	Transistor: can be wired as PNP or NPN, galvanic insulation, protected against short circuit, max. 36 V DC, max. 700 mA per transistor output, 1 A max. in total if both transistor outputs are used; Operating modes: On/Off, Hysteresis, Window, PWM, PFM; Frequency: max. 2000 Hz
Analogue output AO1, AO2	4...20 mA, can be wired as sourcing or sinking, galvanic insulation, protected against reversed polarity of DC, max. loop impedance: 1100 Ω at 36 V DC, 610 Ω at 24 V DC, 100 Ω at 12 V DC Resolution: 6 μA

Technical data - pH/ORP board	
Power consumption	0.1 VA
pH/ORP input	simultaneous pH and ORP measurement with input for electrochemical pH/ORP
Temperature input	Pt100/Pt1000, 2 or 3 wires
pH measurement	
Measuring range	-2.0...16 pH or -600...+600 mV
Resolution	0.01 pH or 0.1 mV
Measurement deviation	±0.02 pH or 1 mV + error of the pH probe*
Probe type	electrochemical
ORP measurement	
Measuring range	-2000...+2000 mV
Resolution	0.1 mV
Measurement deviation	±1 mV + error of the ORP probe*
Probe type	electrochemical
Temperature measurement	
Measuring range	-25...+130°C (-20...+266°F)
Resolution	0.1°C (0.18°F)
Measurement deviation	±1°C (1.8°F) + error of the temperature probe*
Probe type	Pt100/Pt1000, 2 or 3 wires

* see related probe data sheet

Technical data - conductivity board	
Power consumption	0.25 VA
Conductivity input	Operation with 2- or 4-pole-technology sensors
Temperature input	Pt100/Pt1000, 2 or 3 wires
Conductivity/Resistivity measurement	
Conductivity	
Measuring range	0 µS/cm...2 S/cm (function of the conductivity cell)
Resolution	1 nS/cm
Measurement deviation	±0.5% of measured value + error of the conductivity probe*
Resistivity	
Measuring range	0.5 Ωcm...100 MΩcm (function of the conductivity cell); 5.0 Ω...1 MΩ (conductivity board alone)
Resolution	0.1 Ω.cm
Measurement deviation	±0.5% of measured value + error of the conductivity probe*
Temperature measurement	
Measuring range	-40...+200°C (-40...+392°F)
Resolution	0.1°C (0.18°F)
Measurement deviation	±1°C (1.8°F) + error of the temperature probe*
Probe type	Pt100/Pt1000, 2 or 3 wires

* see related probe data sheet

Environment conditions and standards - Mainboard, pH/ORP, conductivity, input and output boards

Ambient temperature		Protection class	acc. to EN60529
Operation (with/without memory card ¹⁾)		Panel-mounted version	IP65 (panel-mounted, cabinet closed) IP20 (panel-mounted, inside the cabinet) NEMA250 4X (panel-mounted, in front of the closed cabinet)
Only Mainboard	<ul style="list-style-type: none"> Panel-mounted and 110...240 V AC wall-mounted version: -10...+70°C (14...+158°F) 12...36 V DC wall-mounted version: -10...+75°C (14...+167°F) 	Wall-mounted version	IP65, IP67, if the following conditions are met: - glands body tightened with a tightening torque of 5.5 Nm±20%, made at factory - glands blanked off or wired - gland nuts tightened with a tightening torque of 4.5 Nm±20% - housing closed - 4 screws of cover cross tightened with a tightening torque of 1.4 Nm±20%
Min. 1 additional board	<ul style="list-style-type: none"> all versions: -10...+60°C (14...+140°F) 		
Storage	<ul style="list-style-type: none"> all versions:-20...+70°C (-4...+140°F), limited to -10...+70°C (14...+140°F) if memory card is inserted 		
Relative humidity	< 85%, without condensation	Standard and directives CE	The applied standards, which verify conformity with the EU Directives, can be found on the EU Type Examination Certificate and/or the EU Declaration of conformity (if applicable)
Height above sea level	max. 2000 m	Certification	
	¹⁾ if a different memory card is used, observe the operating temperatures specified by its manufacturer	UL-Listed for US and Canada	 Measuring Equipment E237737 61010-1 + CAN/CSA-C22.2 No.61010-1



If the device is mounted in a humid environment or outside the maximum allowed voltages are **35 V DC** instead of 36 V DC.

Dimensions [mm]

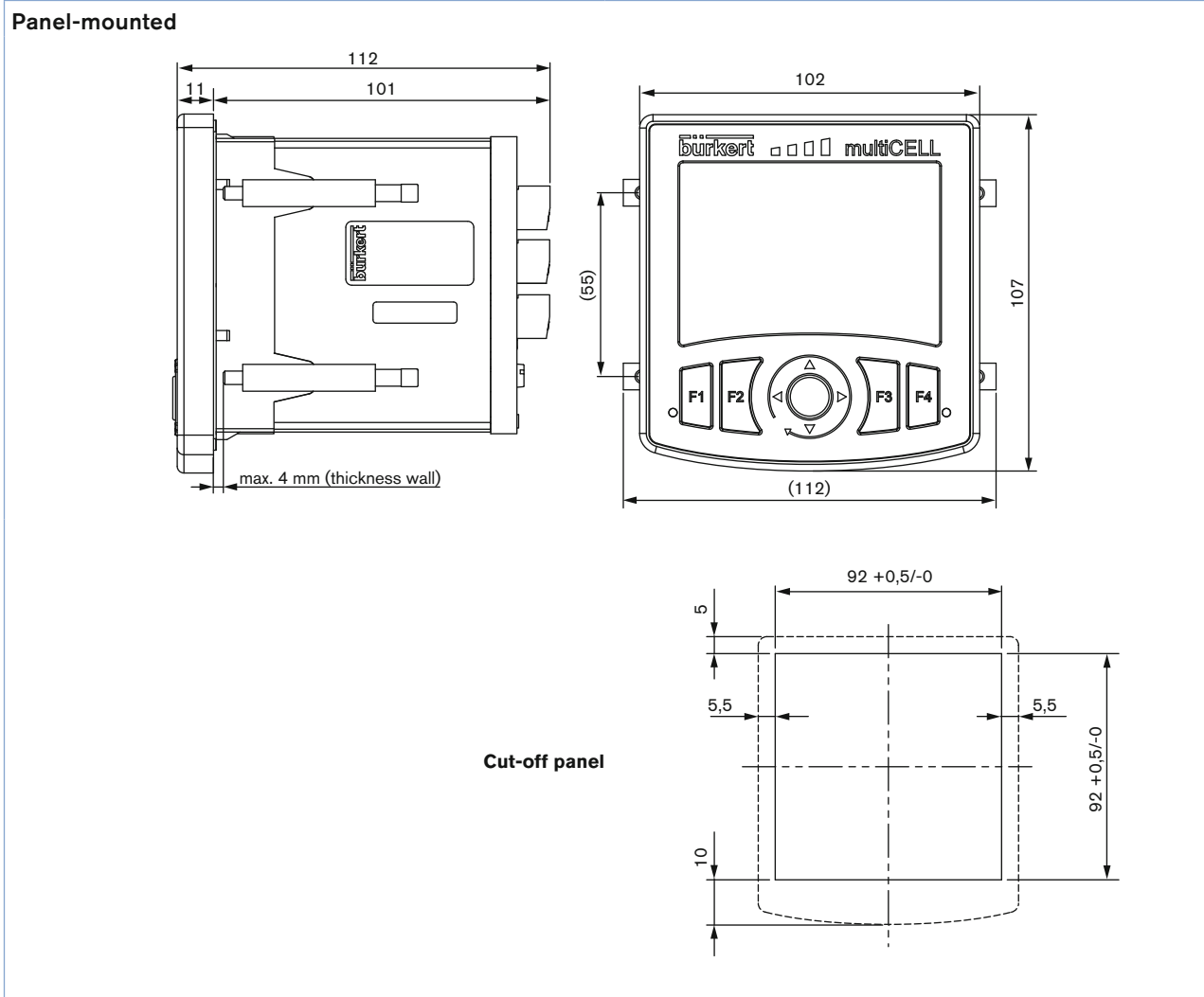

Dimensions [mm]

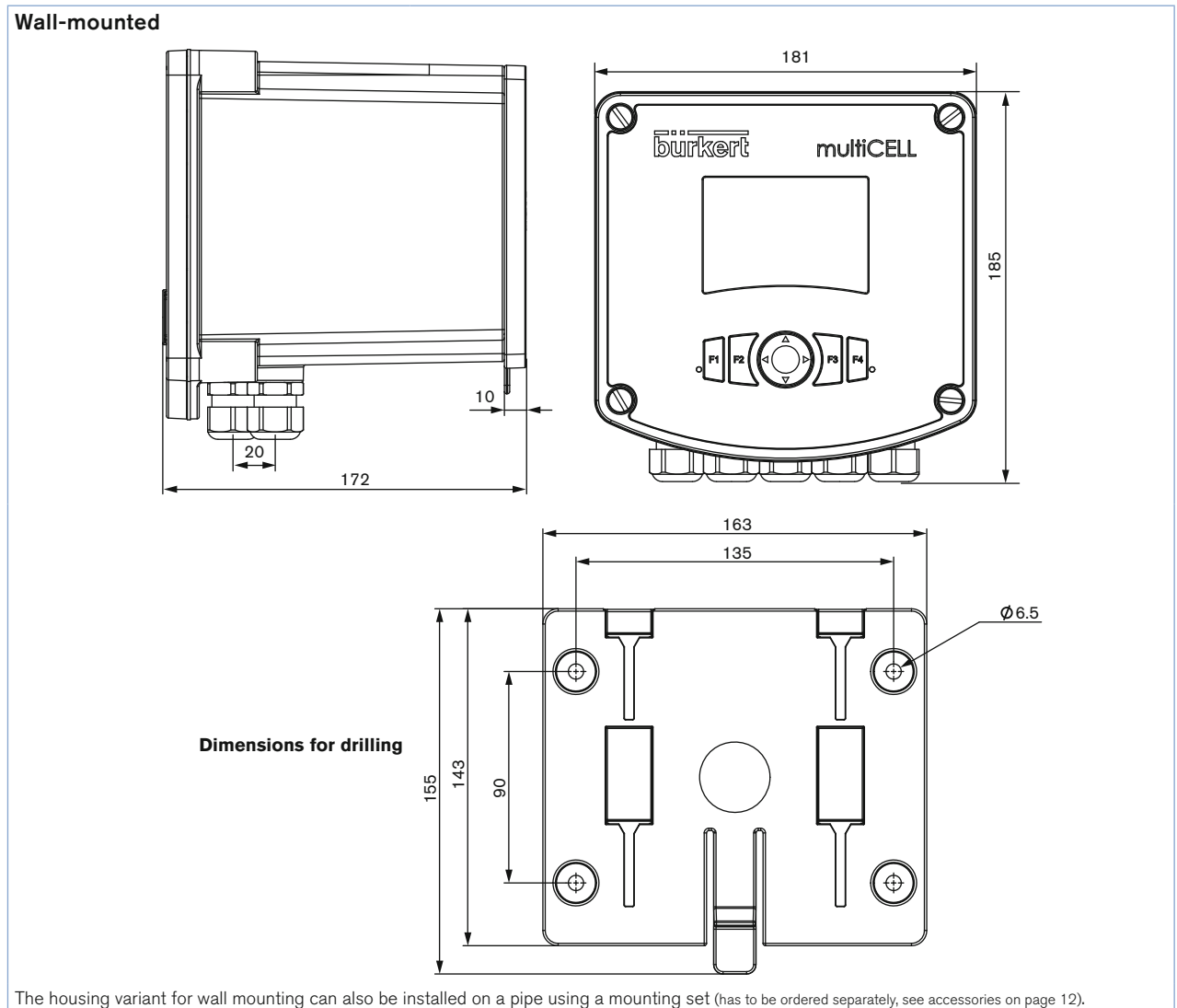

Principle of operation

The transmitter/controller is given by the internal board based structure capable to handle different types of sensors and selectively execute operations on the measurement values. From simple measurement and standard signal output and assignment of integrated mathematical formulas for selectable values up to control and dosing tasks all that can run in parallel.

The boards for signals and functions can be easily connected to each other by configuration and with setting individual parameters all the functionality can be adapted to the actual process conditions.

The base unit is either a panel-mounted version or a wall-mounted version and handles analogue and digital signal outputs, digital inputs and the front is supplied by a backlit graphical display. Up to six slots are available, which depending on the applications, can be occupied with boards for pH/ORP, conductivity, a board with additional analogue and digital outputs as well as a board with analogue and additional digital inputs. There is no need for a separate 4...20 mA transmitter: the pH, conductivity boards accept raw signals from sensors.

Though highly functional the multiCELL can be operated easily and intuitively. The base for this is the large graphical display and the dynamically assigned function keys. Clearly arranged menu and board structures allow easy configuration and setting of parameters and offer a high transparency for the functions in use. Four user views can be configured by the operator. This allows the user to design a view himself displaying a value arrangement which he likes to see simultaneously and this can be available 4 times and independent from each other.

For data collection and storage e.g. of measurement values there is an optional data logger available which uses the memory card if inserted in the card slot. Uploading and restoring the complete database including the application special parameter settings of the complete 8619 and updating firmware via the memory card is available as standard.

Construction

The mainboard slot enables:

- connection to the transmitter/controller power supply
- to power another device
- to dispose of 2 digital inputs (DI), 2 analogue (AO) and 2 digital (DO) outputs

Memory card slot :

- For upload and download of parameter settings
- Software updates and functional upgrades

Simple operation: insert the memory card into the small slot on the rear of the device.

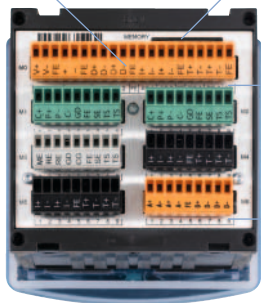

The mainboard slot enables:

- to dispose of 2 digital inputs (DI), 2 analogue (AO) and 2 digital (DO) outputs

Additional board slots (up to 6) to choose among:

- board for conductivity sensor and/or temperature sensor (green connector)
- board for pH/ORP sensor and/or temperature sensor (light grey connector)
- board for 2 analogue and 2 digital outputs (black connector)
- board for 2 analogue and 2 digital inputs (small orange connector)

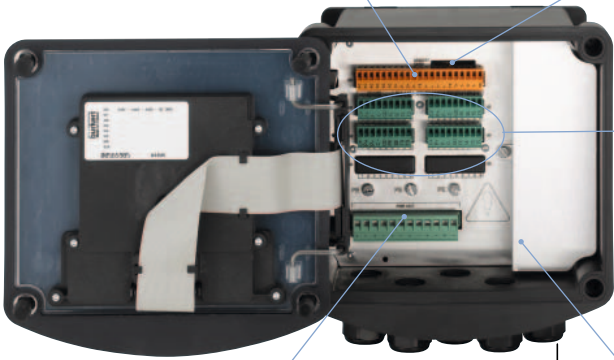

The power charges slot enables:

- to power another device

Memory card slot :

- For upload and download of parameter settings
- Software updates and functional upgrades

Simple operation: insert the memory card into the small slot on the rear of the device.

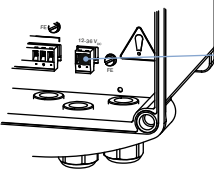

The power supply slot enables:

- connection to the transmitter/controller power supply (behind the protecting cover for 110...240 V AC version)

Additional board slots (up to 6) to choose among:

- board for conductivity sensor and/or temperature sensor (green connector)
- board for pH/ORP sensor and/or temperature sensor (light grey connector)
- board for 2 analogue and 2 digital outputs (black connector)
- board for 2 analogue and 2 digital inputs (small orange connector)

Display and dynamic soft keys

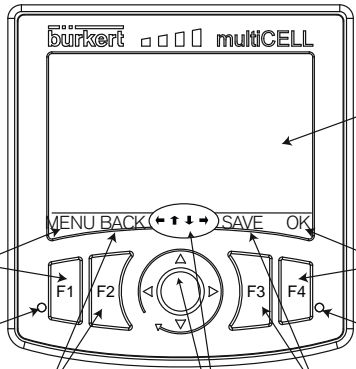

Light blue backlighted LC graphic display

LED

To activate the first dynamic function on the very left side, press F1

To activate the second dynamic function, press F2

The navigation keys allows to move the cursor in vertical and horizontal directions
The pointer above the navigation key indicates the directions which are usable related to the current display

To activate the third dynamic function, press F3

To activate the dynamic function on the very right side, press F4

LED

Process diagram

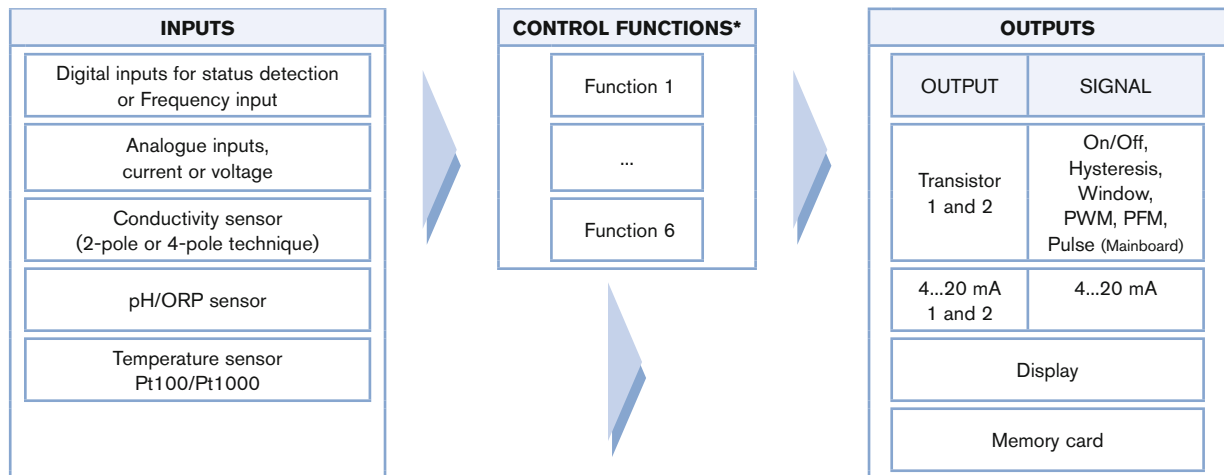

* simultaneously and independently operating

List of available functions

The transmitter/controller allows to allocate each sensor signal to a function (such as dosage, for example) fully configurable by the user. According to the model the following functions are offered as standard or as option

Functions	Availability	Formula	Example for usage
Arithmetic	Basic for all models	A+B, A-B, A/B	arithmetic operation between 2 values with same units. A or B can be a result of another function
PASS	Basic for all models	$\frac{A}{B} \times 100\%$	calculates a flow ratio between 2 values. e.g: reverse osmosis
REJECT	Basic for all models	$(1 - \frac{A}{B}) \times 100\%$	calculates a reject ratio between 2 values. e.g: reverse osmosis
DEVIAT	Basic for all models	$(\frac{A}{B} - 1) \times 100\%$	calculates a deviation ratio between 2 values.
PROP	Basic for all models		calculates an output in proportion to a scaled input
ON/OFF	Basic for all models	On/Off control loop	for any type of input
Flow rate measurement	As base for model item no. 560205, 560213, 565984, 565985, 565986, 565987 for others as option		allows both digital inputs to be used as frequency inputs for flow measurement (in standard for base unit) or coexistent with analytical boards (in option for others devices)
PID	As option	Continuous control loop	for any type of input and with internal or external setpoint
Time dosing	As option		e.g. for cooling tower application. Dosing of 1 or 2 biocides in the circuits, at fixed time intervals or by defining dosing during one week, with 2 dosings per day. Can be connected to an ON/OFF conductivity function for prebleed.
Special Chemical batch (Volume dosing)	As option		specifically for cooling tower application. A defined volume of water is counted, then an actuator is energized during a defined time to add a chemical and the water volume being counted is resetted.
Concentration	As option		the concentration curves of NaCl, H ₂ SO ₄ , HNO ₃ , NaOH, HCl are implemented for use in complete concentration range and not only in low concentration.
Data logging on memory card	As option		up to 16 values can be stored at a defined time interval.

List of available functions (continued)

Concentration tables multiCELL

If multiCELL 8619 is equipped with an conductivity board, multiCELL is able to calculate the concentration depending on the measured conductivity and temperature. Therefore concentration tables for binary mixtures of (five) different substances and water are available. This one of the nine concentration ranges has to be selected which fits perfect to the application.

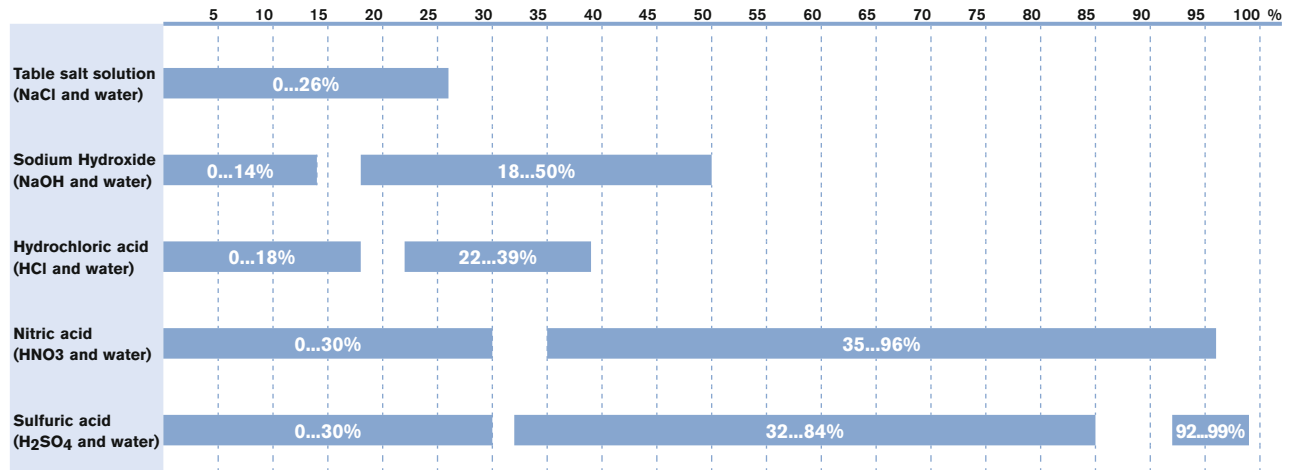

Menu structure

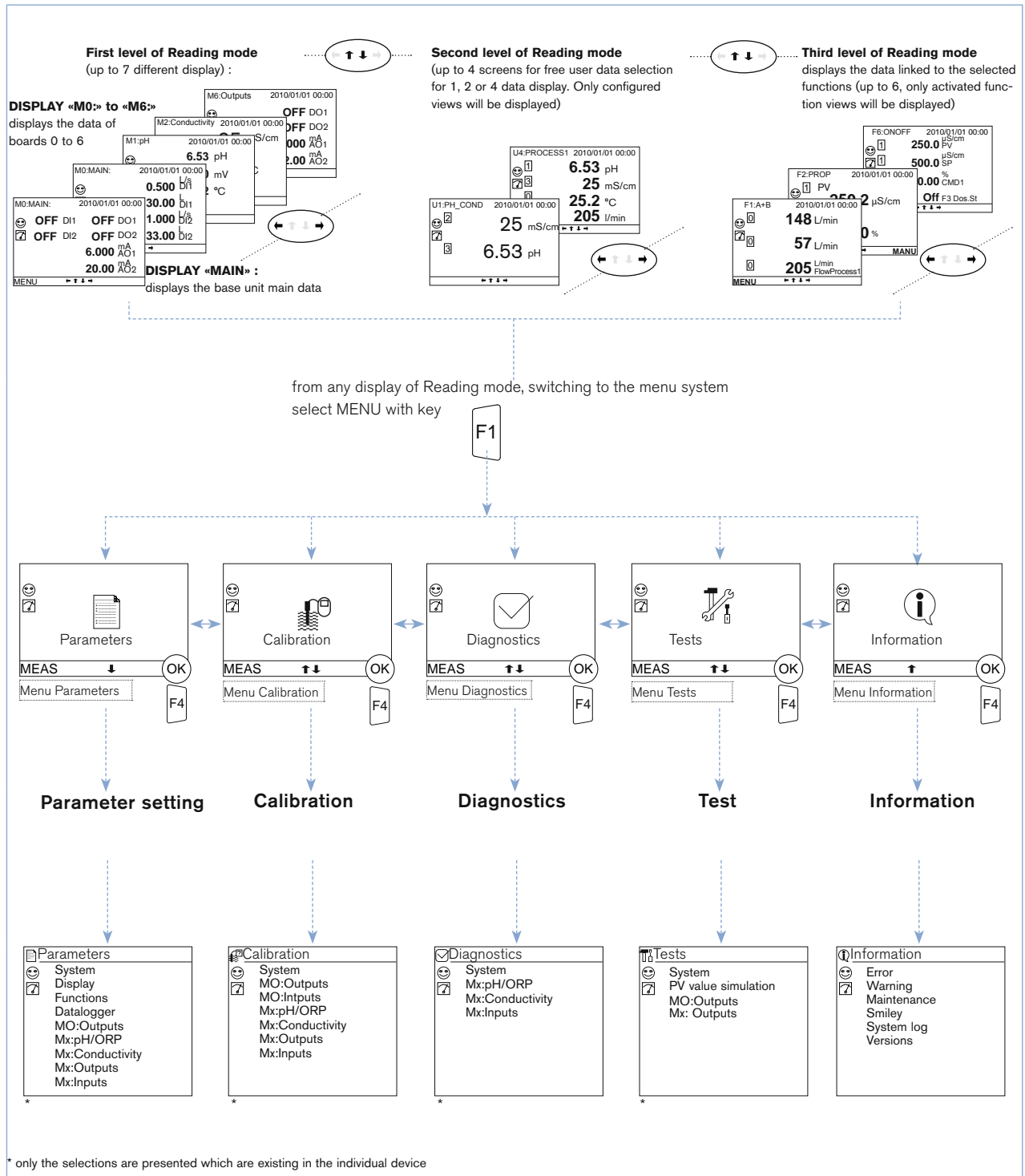

Ordering chart for multiCELL transmitter/controller Type 8619

Description	Inputs			Outputs			UL approvals	Item no.		
	Digital (DI) (On/Off or frequency)	Analogue (AI) 0/4...20 mA current and/or 0...2, 0...5, 0...10 V DC voltage	Number and type of sensor raw signals	Pt100/Pt1000	Transistor (DO) (PWM or PFM or On/Off or pulse)	Analogue (AO) 4...20 mA		Panel-mounted version 12...36 V DC**	Wall-mounted version 12...36 V DC**	Wall-mounted version 110...240 V AC
BASE unit with flow measurement (Mainboard)	2	-	-	-	2	2	No	560 205	565 984	565 985
							Yes ¹⁾	560 213	565 986	565 987
pH/ORP (Mainboard + 1 pH/ORP board)	2	-	1 (pH/ORP)	1	2	2	No	560 200	565 988	565 989
							Yes ¹⁾	560 208	565 990	565 991
pH/ORP (Mainboard + 2 pH/ORP boards + 1 output board)	2	-	2 (pH/ORP)	2	4	4	No	560 202	565 992	565 993
							Yes ¹⁾	560 210	565 994	565 995
CONDUCTIVITY (Mainboard + 1 con- ductivity board)	2	-	1 (Cond.)	1	2	2	No	560 201	565 996	565 997
							Yes ¹⁾	560 209	565 998	565 999
CONDUCTIVITY (Mainboard + 2 con- ductivity boards + 1 output board)	2	-	2 (Cond.)	2	4	4	No	560 203	566 000	566 001
							Yes ¹⁾	560 211	566 002	566 003
pH/ORP and CONDUCTIVITY (Mainboard + 1 pH/ORP board + 1 con- ductivity board + 1 output board)	2	-	1 (pH/ORP) + 1 (Cond.)	2	4	4	No	560 204	566 004	566 005
							Yes ¹⁾	560 212	566 006	566 007
INPUT (Mainboard + 1 input board)	4	2	-	-	2	2	No	563 960	566 008	566 009
							Yes ¹⁾	563 961	566 010	566 011
pH/ORP + INPUT (Mainboard + 1 pH/ORP board + 1 input board + 1 out- put board)	4	2	1 (pH/ORP)	1	4	4	No	563 962	566 012	566 013
							Yes ¹⁾	563 963	566 014	566 015
CONDUCTIVITY + INPUT (Main- board + 1 conductivity board + 1 input board + 1 output board)	4	2	1 (Cond.)	1	4	4	No	563 964	566 016	566 017
							Yes ¹⁾	563 912	566 018	566 019

¹⁾  UL-Listed (Measuring Equipment E237737) for Panel-mounted and Wall-mounted version

**  If the device is mounted in a humid environment or outside the maximum allowed voltages are **35 V DC** instead of 36 V DC.

Notes regarding the ordering of above mentioned multiCELL transmitter/controller:

- The above items are equipped of arithmetic, PASS, REJECT, DEVIAT, PROP, ON/OFF functions in standard (see p. 13, List of available functions). In the BASE unit the Flow measurement function is also a standard function, the other functions are available as option. Please also use the "request for quotation" form on page 13 for ordering a device with additional options.
- If a totalizer function is required then a Flowmeter has to be connected via a digital input (mainboard or input board)

Ordering chart for additional software functions for Type 8619

Use the following order codes only in case you already own a 8619 and you like to add one or more of the given functions to your device.

 **Please don't forget to note down the Item no. and serial number (see the device label) of your multiCELL on your order.**

Software option	Remark	Item no.
PID control	-	561 836
Data Logger	SD card is not included.	561 837
Chemical dosing (e.g. cooling tower)	The "Dosing" option also activates the "Flow" option if it does not exist by default in the device.	561 838
Flow measurement	Already be contained in the base unit device (560 205 and 560 213)	561 839
Concentration measurement of selected fluids	Requires at least one conductivity hardware board	561 840

Remark: the function upload and download of the complete data set of the 8619 is available as standard and does not need the data logger option

Ordering chart for accessories for Type 8619

Description	Item no.
SDHC Memory Card - Class 10 - 8 GB	564 072
Mounting set for pipe mounting	564 596

Examples for interconnection possibilities with other Bürkert devices

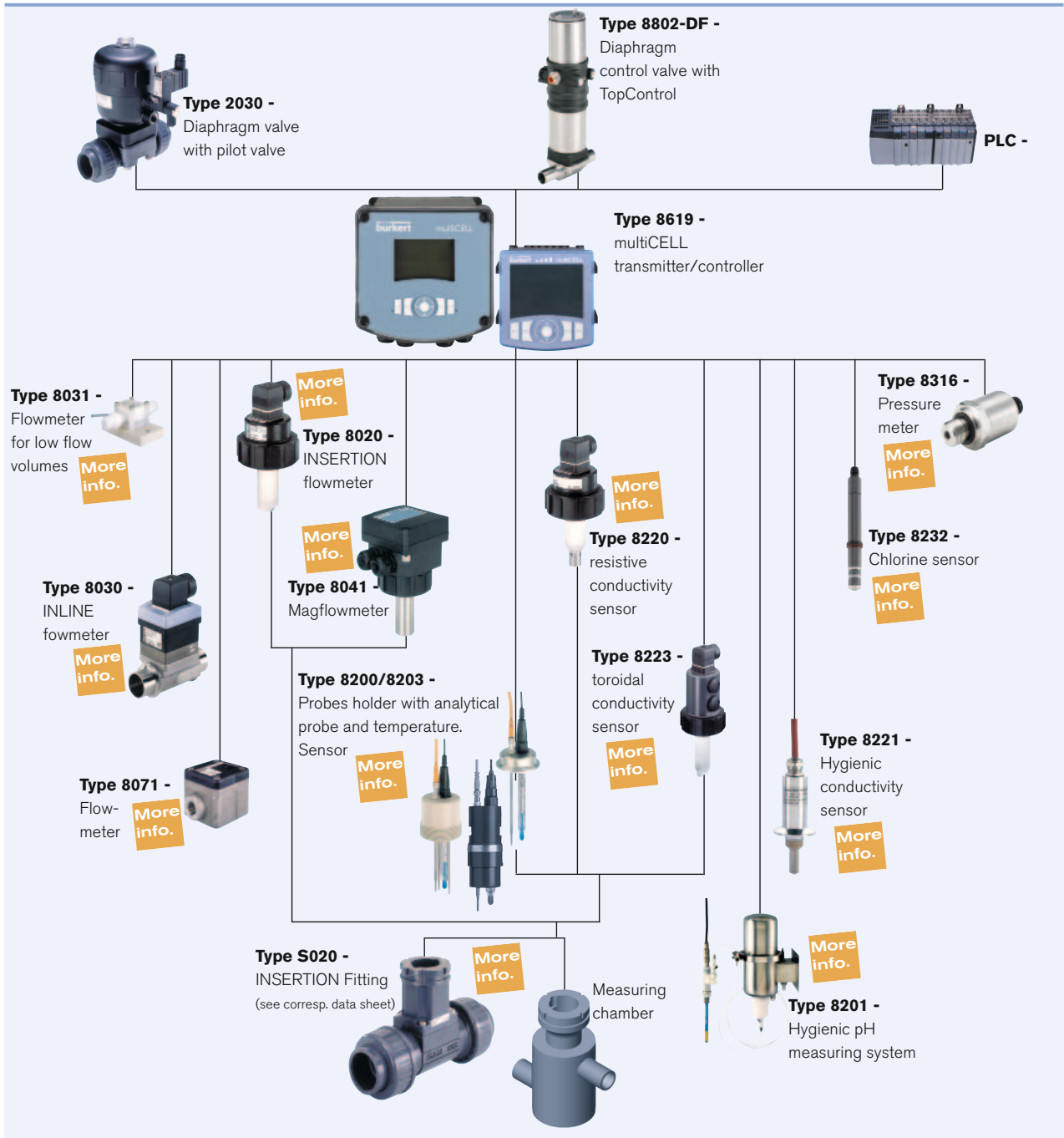

When you click on the orange box "More info." below, you will come to our website for the resp. product where you can download the data sheet.



You will find more info about sensor-multiCELL connection cable in the data sheet of the selected sensor type. Please consult the corresponding data sheet.

multiCELL Transmitter/controller Type 8619 - request for quotation

Note
You can fill out the fields directly in the PDF file before printing out the form.

Please fill in and send to your local Bürkert Sales Centre* with your inquiry or order.

Company:	Contact person:
Customer No.:	Department:
Address:	Tel. / Fax.:
Postcode / Town:	E-mail:

multiCELL Transmitter/controller 8619

Quantity: Desired delivery date:

■ **Models:** Panel-mounted version, 12...30 V DC Wall-mounted version, 12...36 V DC Wall-mounted version, 110...240 V AC

■ **Hardware:** Mainboard¹⁾ (without flow function; if needed please order the flow measurement software option)

Slot M1	<input type="checkbox"/> conductivity + temperature board	<input type="checkbox"/> pH/ORP + temperature board	<input type="checkbox"/> output board ²⁾	<input type="checkbox"/> input board ³⁾
Slot M2	<input type="checkbox"/> conductivity + temperature board	<input type="checkbox"/> pH/ORP + temperature board	<input type="checkbox"/> output board ²⁾	<input type="checkbox"/> input board ³⁾
Slot M3	<input type="checkbox"/> conductivity + temperature board	<input type="checkbox"/> pH/ORP + temperature board	<input type="checkbox"/> output board ²⁾	<input type="checkbox"/> input board ³⁾
Slot M4	<input type="checkbox"/> conductivity + temperature board	<input type="checkbox"/> pH/ORP + temperature board	<input type="checkbox"/> output board ²⁾	<input type="checkbox"/> input board ³⁾
Slot M5	<input type="checkbox"/> conductivity + temperature board	<input type="checkbox"/> pH/ORP + temperature board	<input type="checkbox"/> output board ²⁾	<input type="checkbox"/> input board ³⁾
Slot M6	<input type="checkbox"/> conductivity + temperature board	<input type="checkbox"/> pH/ORP + temperature board	<input type="checkbox"/> output board ²⁾	<input type="checkbox"/> input board ³⁾

■ **Software:**

PID

Data logger

Chemical dosing (e.g. Cooling Tower) + special batch (The "Dosing" option also activates the "Flow" option if it does not exist by default in the device)

Flow measurement

Concentration Measurement for selected fluids (only if one of the slot is equipped with a conductivity board)

¹⁾ 2 digital inputs + 2 analogue outputs + 2 transistor outputs
²⁾ 2 analogue outputs + 2 transistor outputs
³⁾ 2 analogue inputs + 2 digital inputs

NOTE: If a totalizer function is required then a flowmeter has to be connected via a digital input (mainboard or input board)

DTS 1000130448 EN Version: L Status: RL (released | freigegeben | valide) printed: 03.11.2016

To find your nearest Bürkert office, click on the orange box →

www.burkert.com