

UL LISTED, CSA CERTIFIED, NEMA 4.
I & M SHEET IMP400.

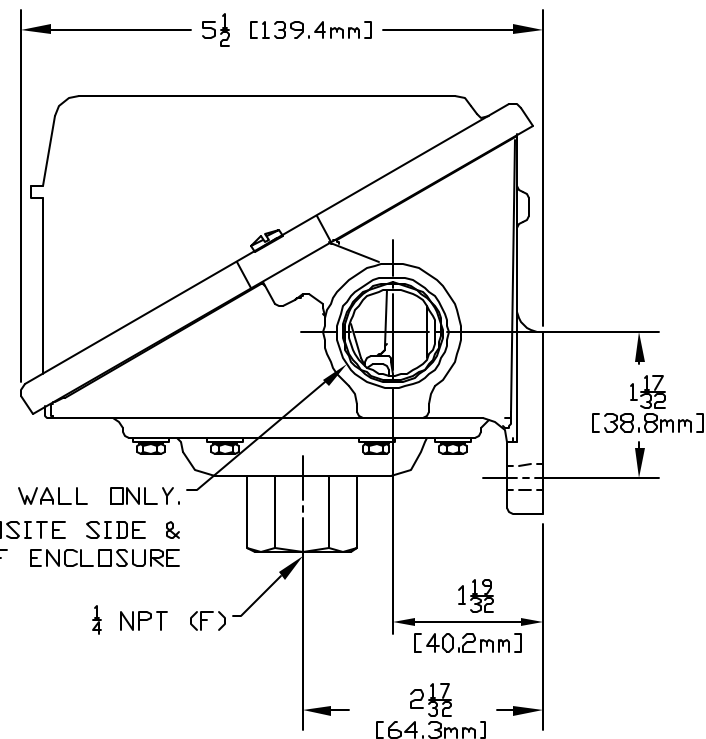
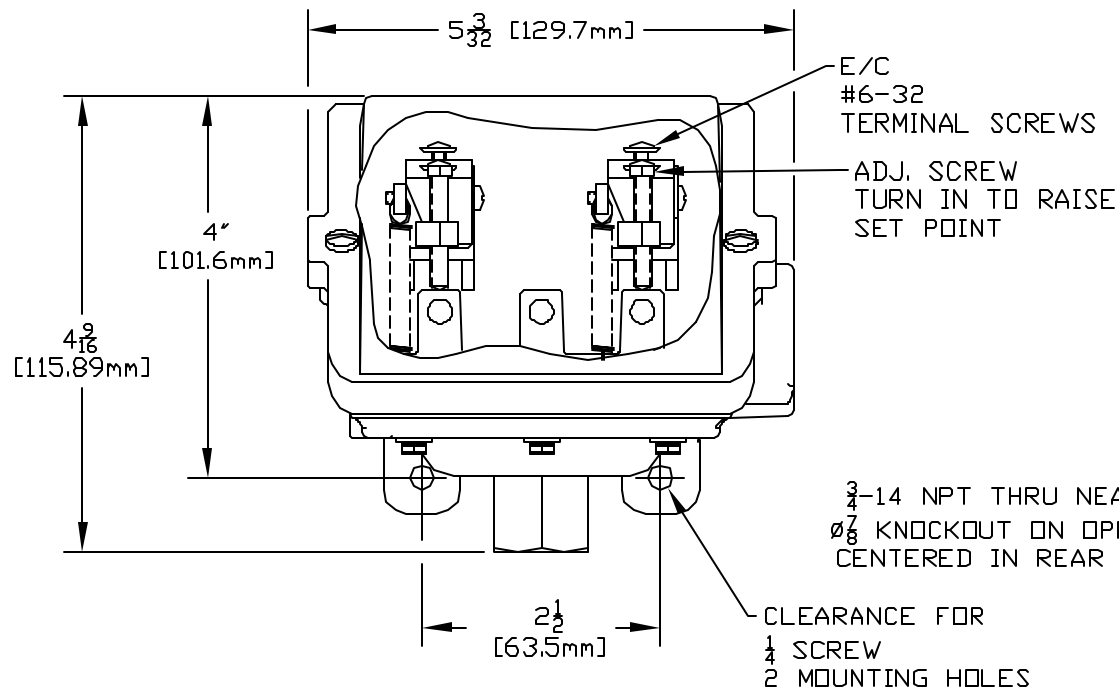

572	0 to 100	0 to 6.9
571	0 to 50	0 to 3.4
570	0 to 20	0 to 1379.0 mbar
MODEL NO.	psi	bar
ADJUSTABLE RANGE		
LOW END OF RANGE ON FALL		
HIGH END OF RANGE ON RISE		

C	REDRAWN, UPDATED ENCLOSURE. ECN#E0821	6-28-04	SR	HN
SYM	DESCRIPTION	DATE	DWN	APPD
REVISIONS				

ORIGINAL DATE	6-24-98
DRWN	PETER WEILER
CHKD	A. BARTER
APPD	A. MINASSIAN
UNLESS OTHERWISE SPECIFIED DIMENSIONS ARE IN INCHES	

TITLE
J402-
570 TO 572



UNITED ELECTRIC
CONTROLS COMPANY
WATERTOWN * MASSACHUSETTS

DF001D

DWG NO
A-13437

DO NOT SCALE THIS DRAWING

SCALE 1:2