

MCF0080/0150/0151/0250/0400/0500 Air Flowmeter NPT Model User's Manual for Installation

Thank you for purchasing this product. Before operating this product described in this User's Manual, please take note of the following points regarding safety. Be sure to keep this manual nearby for handy reference. Please read "Terms and Conditions" from the following URL before ordering and use.
<http://www.azbil.com/products/factory/order.html>

NOTICE

Be sure that the user receives this manual before the product is used. Copying or duplicating this user's manual in part or in whole is forbidden. The information and specifications in this manual are subject to change without notice.

Considerable effort has been made to ensure that this manual is free from inaccuracies and omissions. If you should find an error or omission, please contact the azbil Group.

In no event is Azbil Corporation liable to anyone for any indirect, special or consequential damages as a result of using this product.

© 2009-2016 Azbil Corporation All Rights Reserved.

The MCF air flowmeter uses a μ F (Micro Flow) sensor in its sensing unit. This manual explains the handling precautions, mounting, wiring, setting, operation and main specifications. See the "Installation & Configurations" and "Communications" manuals listed below for the detail handling procedures and the setting methods, etc. These manuals also contain information on using various functions. Please read if necessary.

MCF0080/0150/0151/0250/0400/0500 Air Flowmeter NPT Model User's Manual for Installation & Configuration CP-SP-1293E

MCF Air Flowmeter NPT Model User's Manual for Communication Functions CP-SP-1301E

UNPACKING

Check the following items when unpacking:

- Unit label 81424037-001
- User's Manual (this manual) CP-UM-5573E

SAFETY PRECAUTIONS

Safety precautions are for ensuring safe and correct use of this product, and for preventing injury to the operator and other people or damage to property. You must observe these safety precautions. Also, be sure to read and understand the contents of this user's manual.

Key to symbols

WARNING

Warnings are indicated when mishandling this product might result in death or serious injury to the user.

CAUTION

Cautions are indicated when mishandling this product might result in minor injury to the user, or physical damage to this product.

WARNING

- Never allow gases that are within explosive limits to pass through this device. Doing so could result in an explosion.
- Do not use this device for oxygen gas. Doing so could result in a serious accident.

CAUTION

- Be sure to use this device within the flow rate range stated in the specifications. To prevent excessive flow, use a suitable means to control the supply pressure or use a throttle valve or the like to control the flow rate.
- If damage could result from the abnormal functioning of this device, include appropriate redundancy in the system design.
- If there is a risk of a power surge caused by lightning, use a surge absorber (surge protector) to prevent fire or device failure.
- When carrying the flowmeter or connecting it to the pipe, do not hold it by the measurement module. Doing so could cause damage, or the device could drop, causing an injury.
- To avoid damaging this device, do not use it outside of the operating pressure range. Also, do not subject it to a pressure above its pressure resistance.
- When maintaining or replacing the measurement module, release the internal pressure of this device before removing the measurement module.

MOUNTING

Installation location

Avoid mounting this device in places characterized by any of the following:

- Temperature below -10 °C or above +60 °C
- Humidity exceeding 90 % RH
- Sudden changes in temperature, or condensation
- Corrosive or flammable gases
- Heavy concentration of conductive substances (e.g. dust, salt or iron dust), water droplets, oil mist or organic solvents
- Vibration or shock
- Direct sunlight
- Splashing by water or rain
- Splashing by fluids (e.g. oil, chemicals)
- Constant, heavy splashing by water or dust
- Strong magnetic or electrical fields

Piping

Cautions for pipe installation

- The MCF is a precision instrument. Do not drop it nor subject it to shock.
- Install so that the direction of gas flow matches the arrow on the side of the MCF.
- Do not apply force to the measurement module during installation.
- When attaching the MCF to the pipe, fix the MCF in place and rotate the pipe to the recommended tightening torque.

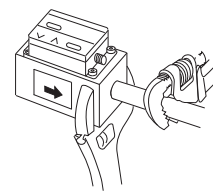

Model number	Pipe size	Recommended tightening torque [N·m]
MCF0080	1/4 inch	12 to 14
MCF0150/0151	1/2 inch	31 to 33
MCF0250	1 inch	36 to 38
MCF0400	1 1/2 inch	59 to 61
MCF0500	2 inch	74 to 76

Foreign matter to enter the MCF. If rust, water droplets, oil mist or dust from the pipe enters the device, measurement error, control error, or damage may occur. Before installation, be sure to flush upstream and downstream piping thoroughly to remove foreign matter.

- Coat the pipe threads with an appropriate amount of sealant except for the top two threads. Too much sealant might cause measurement error or damage.
- When connecting a piping element such as a pipe with a different diameter, a regulator, a filter, or a valve on the upstream side, use the recommended straight pipe section. Failure to do so could cause a measuring error.
- If a reducer or tube fitting is connected without a straight pipe section, the display might indicate a negative flow rate even though air is flowing in the positive direction. "Straight pipe section" refers to a straight pipe with the same diameter as the MCF port. The following types of pipe are suitable: Carbon Steel Pipes for Ordinary Piping (JIS G3452), ANSI schedule 40 or less; Carbon Steel Pipes for Pressure Service (JIS G3454), or ANSI schedule 40 or less; Stainless Steel Pipes (JIS G3459).

- Although there are no restrictions of mounting direction, if the MCF is mounted on a horizontal pipe and the display faces to the side, a measuring error can be caused by the mounting direction. Also, if the unit is mounted on a horizontal pipe with the display facing downward, foreign matter (rust, water droplets, oil mist, dust) in the pipes might accumulate in the sensor, causing measuring error or damage.
- Do not install this device near the outlet of a compressor or bellows pipe, or in a location where the regulator or the check valve causes hunting. Doing so could cause measurement error.

Mounting direction

Normally the MCF is mounted on a horizontal pipe with the display unit facing upward. Though the mounting position is unrestricted, measurement error might be caused by the display direction.

- Normal position on horizontal pipe with display facing upward (Position 1)

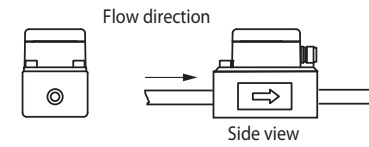

- Horizontal pipe with display facing to the right as seen from air inlet (Position 2)

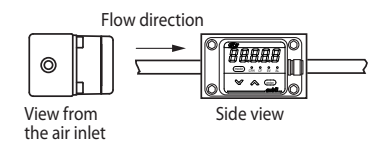

Operating pressure range	Flow rate range	Instantaneous flow rate deviation
0 to 1 MPa	5 to 100 % of full scale flow rate	0.5 % FS per 0.1 MPa \pm 1 digit or less
-0.07 to 0 MPa	5 to 100 % of full scale flow rate	0.5 % FS per 0.01 MPa \pm 1 digit or less

Example:

When the MCF is mounted on horizontal piping with the display unit facing to the right as seen from the air inlet, the instantaneous flow rate deviation is 1.5 % FS \pm 1 digit or less as compared with the accuracy in the normal position at 0.3 MPa.

$$0.5 \% \text{ FS} / 0.1 \text{ MPa} \times 0.3 \text{ MPa} = 1.5 \% \text{ FS}$$

- Horizontal pipe with display facing to the left as seen from air inlet (Position 3)

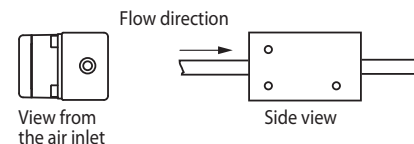

Operating pressure range	Flow rate range	Instantaneous flow rate deviation
0 to 1 MPa	5 to 100 % of full scale flow rate	-0.5 % FS per 0.1 MPa \pm 1 digit or less
-0.07 to 0 MPa	5 to 100 % of full scale flow rate	-0.5 % FS per 0.01 MPa \pm 1 digit or less

Example:

When the MCF is mounted a horizontal piping and the display unit faces the left from the air inlet, the instantaneous flow rate deviation is -1.5 % FS \pm 1 digit or less as compared with the accuracy in the normal position at 0.3MPa.

$$-0.5 \% \text{ FS} / 0.1 \text{ MPa} \times 0.3 \text{ MPa} = -1.5 \% \text{ FS}$$

- Horizontal pipe with display facing downward (Position 4), vertical pipe (Position 5)

The characteristics of the MCF do not change as compared with the normal position. However, if the MCF is mounted on horizontal piping with the display unit facing downward, accuracy might decrease due to accumulated moisture, mist or dust from the air.

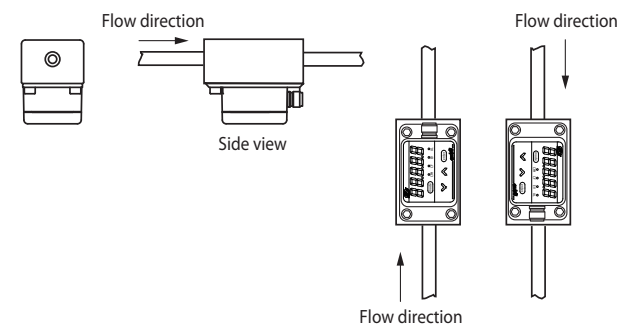

Filter

- If there is a possibility of foreign matter entering the device, install a filter, strainer or mist trap upstream capable of eliminating foreign matter larger than 1 μ m in diameter.

Accuracy and straight pipe length

- Connection with different size pipe, valve or filter "Straight pipe section" refers to a straight pipe with the same diameter as the MCF port. The following types of pipe are suitable: Carbon Steel Pipes for Ordinary Piping (JIS G3452), ANSI schedule 40 or less; Carbon Steel Pipes for Pressure Service (JIS G3454), or ANSI schedule 40 or less; Stainless Steel Pipes (JIS G3459). If a device that is not listed in the table is installed either upstream or downstream, contact the azbil Group for the length of the straight pipe section. If reverse flow is also expected, it is necessary to have the same length of straight pipe downstream as upstream.

Pipe or connected device	Location in relation to the MCF	Straight pipe section for this device	
		For accuracy within specification range (\pm 3 % FS)	For accuracy within \pm 5 % FS
MFF25S mist separator for MCF0080/0150/0151/0250 *3	Upstream	10D	(Not required)
MFF25L mist separator for MCF0400/0500 *3	Upstream	20D	(Not required)
Pipe one size larger in dia. (connected with reducer) *4 *5	Upstream	5D	(Not required)
MCF0080 3/8 inch \rightarrow 1/4 inch	Downstream	(Not required)	(Not required)
MCF0150/0151 3/4 inch \rightarrow 1/2 inch		(Not required)	(Not required)
MCF0250 1 1/4 inch \rightarrow 1 inch		(Not required)	(Not required)
MCF0400 2 inch \rightarrow 1 1/2 inch	Upstream	10D	5D
Pipe one size larger in dia. (connected with reducer) *4 *5	Downstream	5D	5D
MCF0500 2 1/2 inch \rightarrow 2 inch	Upstream	20D	5D
Pipe one size smaller in dia. (connected with reducer) *4 *6	Downstream	(Not required)	(Not required)
MCF0080 1/8 inch \rightarrow 1/4 inch		(Not required)	(Not required)
MCF0150/0151 3/8 inch \rightarrow 1/2 inch		(Not required)	(Not required)
MCF0250 3/4 inch \rightarrow 1 inch	Upstream	25D	10D
MCF0400 1 1/4 inch \rightarrow 1 1/2 inch		5D	5D
MCF0500 1 1/2 inch \rightarrow 2 inch	Downstream	(Not required)	(Not required)
Single elbow *7	Upstream	10D	(Not required)
	Downstream	(Not required)	(Not required)
Double elbow *7	Upstream	10D	10D
	Downstream	(Not required)	(Not required)
Ball valve (full-bore type full open) *8	Upstream	(Not required)	(Not required)
	Downstream	(Not required)	(Not required)
Regulator for MCF0080 *9	Upstream	200D	(Not required)
	Downstream	10D	(Not required)
Regulator for MCF0150/0151/0250/0400/0500 *9	Upstream	30D	(Not required)
	Downstream	5D	(Not required)
Air filter	Upstream	25D	(Not required)

*1 Do not connect a carbon steel pipe for pressure service (JIS G3454) or stainless steel pipe (JIS G3459) that is larger than schedule 40. Doing so might cause a deterioration of accuracy. (If the pipe schedule number is larger, the inner pipe diameter is smaller, resulting in less accuracy.)

*2 The approximate size of the connection port (D) is 8 mm for the MCF0080 (1/4 inch), 15 mm for the MCF0150/0151 (1/2 inch), 25 mm for the MCF0250 (1 inch), 40 mm for the MCF0400 (1 1/2 inch), and 50 mm for the MCF0500 (2 inch).

*3 The straight pipe section lengths given in the right-hand columns above are for connection of a filter the same size (internal diameter) as the MCF.

*4 MCF models and connecting pipe sizes are shown below.

Model No.	1/8 inch	1/4 inch	3/8 inch	1/2 inch	3/4 inch
MCF0080	▲	●	+		
MCF0150/0151			▲	●	+

Model No.	3/4 inch	1 inch	1 1/4 inch	1 1/2 inch	2 inch	2 1/2 inch
MCF0250	▲	●	+			
MCF0400			▲	●	+	
MCF0500				▲	●	+

- ▲ Pipe one size smaller than the MCF
- Pipe the same size as the MCF
- + Pipe one size larger than the MCF

*5 The figure below shows an example of the MCF0080 connected with reducers. The accuracy is within the specification range ($\pm 3\%$ FS).

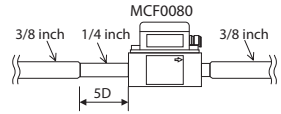

When connecting the MCF to a pipe 2 sizes larger than the MCF port (for example, the MCF0080 to a 1/2 inch pipe), to determine the straight pipe length use the section of the table marked "Pipe one size larger in dia. (connected with reducer)."

*6 The figure below shows an example of the MCF0150 connected with reducers. The accuracy is within the specification range ($\pm 3\%$ FS).

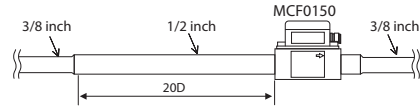

Do not connect a smaller size pipe to the MCF without a straight pipe section. Doing so might cause a reverse flow in the measurement module, even though there is a regular forward flow in the main flow path. Therefore the display might indicate a negative value or an extremely low flow rate compared with the actual rate.

When connecting the MCF to a pipe 2 sizes smaller than the MCF port (for example, the MCF0150 to a 1/4 inch pipe), to determine the straight pipe length use the section of the table marked "Pipe one size smaller in dia. (connected with reducer)." In addition, on the upstream side add 5D to the straight pipe length.

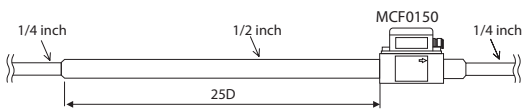

*7 The figures below show examples of connection with a single elbow and double elbow.

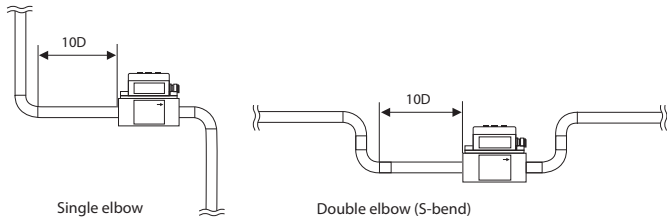

*8 This valve does not have an internal throttle. If possible, install a flow regulating valve downstream from the MCF.

*9 A regulator should be 200D away from this device. The pipe from the regulator to this device may consist of an air tube and elbow. However, if the elbow is connected to this device, use the necessary straight pipe section for the elbow.

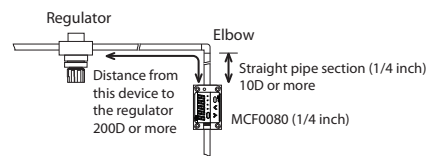

WIRING

● Cautions for wiring

- Supply a power voltage within the specified range.
- Keep the MCF wiring (conduit) away from power wiring or high voltage wires.
- When connecting the connector, push the two parts together, and then tighten the nut by hand to 0.4 to 0.6 N·m. Improper tightening can damage the MCF, or lead to a loss of the IP65 seal, or allow the connector to come loose due to vibration.
- Do not pull the cable forcibly, and do not lift the MCF by the cable (pull-out strength 40 N max., bending force 20 N max.) Do not bend the cable repetitively or put a constant pulling stress on it.

- Do not rotate the cable where it joins the connector (see figure). Doing so might rotate the connector, twisting and damaging the wires inside.

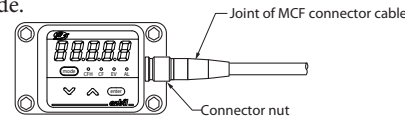

- Before wiring the MCF, be sure to turn the power off.
- Connect a load with a resistance of not more than 300 Ω for the instantaneous flow rate output.
- Keep water away from the cable and from the end of the connector while wiring.
- Be sure to check that the wiring is correct before turning the power on. Incorrect wiring could cause damage or malfunction.
- Power source ground, instantaneous flow rate output common, and event output common lines are all connected inside this device. If these lines are connected to an external device through a common power supply, interference could occur causing device failure or faulty operation.
- Take care that the event output does not exceed the output rating of this device. If a relay is used, the coil should have a built-in surge absorption diode. Otherwise device failure could occur.

● Connector

Pin number	Signal	MCF0_____D01_____ with 4 to 20 mA output	MCF0_____D10_____ with RS-485 communications
1	V+	24 Vdc	24 Vdc
2	I+/DB	Instantaneous flow rate output (4 to 20 mA)	RS-485 communications (DB)
3	COM	COM	COM
4	EV/DA	Event output	RS-485 communications (DA)

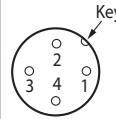

● Note

- Wire color and pin number for MCF connector cable

Pin number	Signal	Line color
1	V+	Brown
2	I+/DB	White
3	COM	Blue
4	EV/DA	Black

● Wiring example

- 4 to 20 mA output

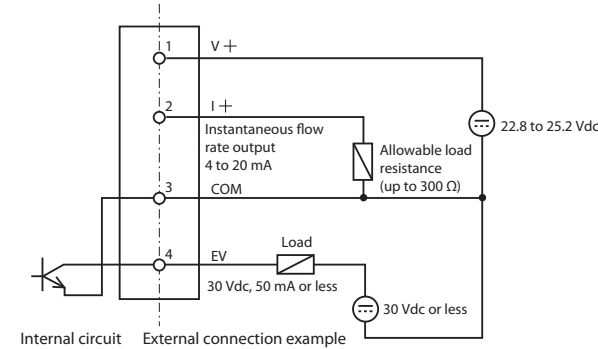

- RS-485 communications

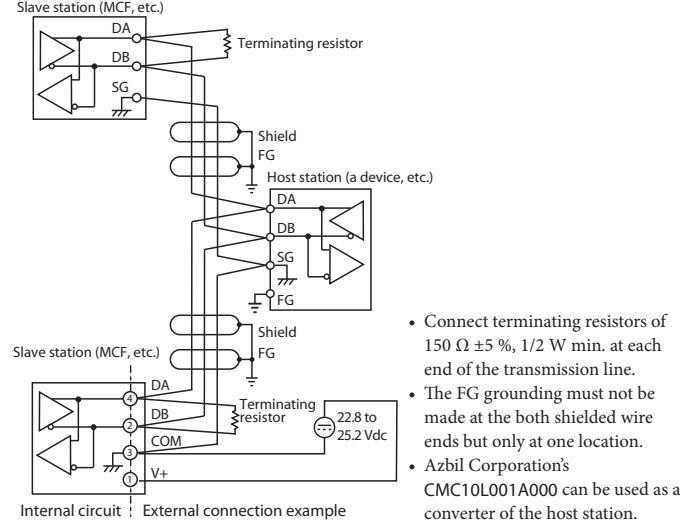

- Connect terminating resistors of 150 Ω $\pm 5\%$, 1/2 W min. at each end of the transmission line.
- The FG grounding must not be made at the both shielded wire ends but only at one location.
- Azbil Corporation's CMC10L001A000 can be used as a converter of the host station.

PART NAMES AND FUNCTIONS

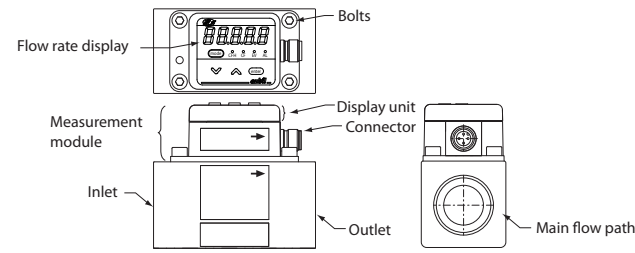

Flow rate display:

This 7-segment LED indicates instantaneous flow rate or integrated flow amount. For the integrated flow, the first 4 digits and last 5 digits are displayed separately. The 7-segment display also indicates settings in setting mode and alarm codes when an alarm occurs.

LED lamp:

- [CFH] Lights up while instantaneous flow rate is indicated.
- [CF] Lights up while integrated flow is indicated.
- [EV] Synchronized with event output
- [AL] Lights up when an alarm occurs

Keys:

- [mode] Changes the display or switches to setting mode, etc.
- [V][^] Increases/decreases the value of a setting, changes the display mode, etc.
- [enter] Used to finalize function settings and parameter settings

Main flow path:

Connects to pipes. Inlet and outlet are marked

Measurement module:

Removable for maintenance. Can be changed with a new one for the MCF0250, MCF0400 and MCF0500.

Display unit:

Can be rotated in a plane parallel to the flow path. Rotates 180° clockwise and 90° counterclockwise, for viewing from any direction. If the display is rotated beyond the range of movement stated above, the internal connector may be disconnected, disabling the display unit.

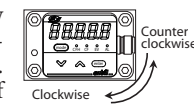

SETTING AND OPERATION

■ State transitions

When the power is turned on, the normal indication is indicated on the instantaneous flow rate display. Normal indication means display of the instantaneous flow rate or integrated flow and no display, depending on the setting of function setup $\text{C}04$.

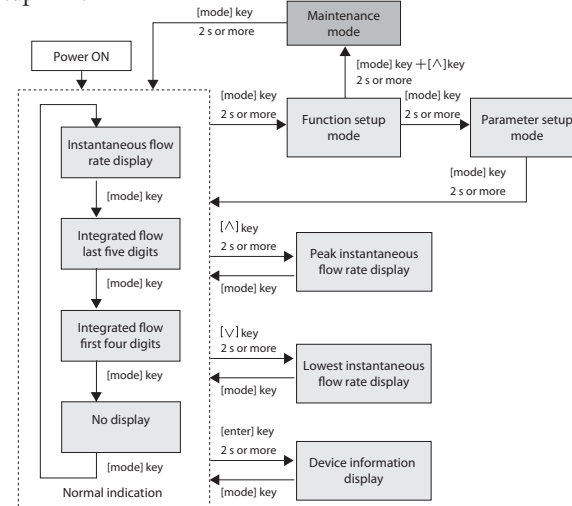

■ Resetting totalized flow counter

To reset the integrated flow total, press and hold [V] key and [^] key at the same time for 5 seconds or more while the first or last part of the total flow amount is indicated on the display.

Note:

- If an alarm occurs, the alarm code and normal indication alternate every two seconds.
- For details of the peak instantaneous flow rate display, lowest instantaneous flow rate display, device information display and maintenance mode, refer to the following user's manual: MCF0080/0150/0151/0250/0400/0500 Air Flowmeter NPT Model User's Manual for Installation & Configuration (CP-SP-1293E)
- In the Lights Out mode, all LEDs are off except the "CF (CFH)" LED. If there is an alarm, the alarm indicator lights up.

● Function settings

Func No.	Name	Settings	Factory setting	Description
C01	Key lock setting	00: Unlocked 01: Key locked	00	Even with the keys locked, it is possible to cancel the key lock. If any key is pressed while the keys are locked, "LoC." is displayed.
C02	Flow rate units	Unit of instantaneous flow rate and integrated flow 00: L/min, L 01: m ³ /h, m ³ 02: m ³ /min, m ³ 03: kg/h, kg 04: CFH, CF 05: CFM, CF	04	Even if the units are changed, the current integrated flow amount will remain as is, and will not be converted to the new units. After changing the units, it is necessary to clear the current integrated flow count. Also, reset $R_{0,20}$ (in Parameter settings). If you change the flow rate engineering unit, affix the appropriate unit label (included with the MCF) on top of the current label. If the reference temperature is changed, the peak value and the lowest value are reset.
C03	Event output	00: Not used 01: Instantaneous flow rate upper limit 02: Instantaneous flow rate lower limit 03: Within range for instantaneous flow rate 04: Instantaneous flow rate upper limit (reversed output) *1 05: Instantaneous flow rate lower limit (reversed output) *1 06: Within range for instantaneous flow rate (reversed output) *1 07: Set value reached by integrated flow count-up 08: Set value reached by integrated flow count-up (reversed output) *1 09: Zero reached by integrated flow count-down 10: Zero reached by integrated flow count-down (reversed output) *1 11: Integrated pulse output (minimum unit) *1 *4 12: Integrated pulse output (minimum unit X 10) *1 *4 13: Integrated pulse output (minimum unit X 100) *1 *4 14: Alarm 15: Alarm (reversed output) *1	00	Reversed output is high when the event is OFF and low when the event is ON. To cancel the event output for integrated flow count-up or count-down, reset the count or change the event output type. Since models with RS-485 communications have no event output terminals, the "EV" "LED" lamp indicates an event but not event output.
C04	Normal indication	00: Instantaneous flow rate indication 01: Integrated flow last five digits 02: Integrated flow first four digits 03: No display	00	This setting determines what is indicated on the flow rate display after the power is turned on. After exiting normal indication mode, the device enters function setup mode.
C07	Event standby	00: Disabled 01: Enabled	00	
C08	Gas type	00: Air/ nitrogen (fixed)	00	
C10	Operating pressure	00: 0.3 MPa 01: 0.1 MPa 02: 0.5 MPa 03: 0.7 MPa	00	If the mounting direction is Position 2 or Position 3, it is possible to reduce the error caused by the mounting direction by adjusting the pressure correction value (in maintenance mode) and the operating pressure. See Installation and Configuration CP-SP-1293E for details.
C11	Reference temperature	00 to 35 °C (every 1 °C)	00	If the reference temperature is changed, the peak value and the lowest value are reset.
C12	Integrated flow option	00: Integrate only normal flow 01: Integrate both normal flow and reverse flow (as a minus)	00	
C14	Integrated flow pulse width	00: 50 ms 01: 250 ms 02: 500 ms	00	
C15	Analog alarm output *2	00: Not used 01: Upper level (variable) 02: Lower level (fixed)	00	For alarms such as sensor error or memory error, the level of current set here is output. For these alarms, flow rate display is "0" while an alarm occurs.

Func No.	Name	Settings	Factory setting	Description
ⒸⒹ	Device address *3	00 to 99	00	For details, refer to CP-SP-1293E or CP-SP-1301E
ⒸⒺ	Transmission speed *3	00 to 03	02	
ⒸⒻ	Communication conditions *3	00 to 11	00	
ⒸⒼ	Communications type *3	00 to 01	00	

*1 If selected for RS-485 communications models, no communications begin.

*2 Cannot be selected for RS-485 communications models.

*3 Can be selected for RS-485 communications models only.

*4 Minimum unit

MCF0080/0150/0151/0250: 10 L/1 pulse (0.01 m³/1 pulse, 0.01 kg/1 pulse)
MCF0400/0500: 100 L/1 pulse (0.1 m³/1 pulse, 0.1 kg/1 pulse)

Parameter settings

Func No.	Name	Setting range	Factory setting	Description
ⒶⒶⒹ	Flow rate assignment for 20 mA analog output *1, *6	0 to 400 % FS equiv. *5	Depends on model number	• Factory settings are shown below. MCF0080 → 200 MCF0150 → 500 MCF0151 → 1000 MCF0250 → 3000 MCF0400 → 6000 MCF0500 → 12000 • The decimal point is not shown in the setting range. Depending on the model number the decimal point is added to the display. • If the setting is less than 10 % of the FS flow rate, the desired output may not be possible. Also, if the setting is zero, when there is an alarm the output will be fixed (unchanging). • If the flow rate units are changed in function setup ⒸⒹ, set ⒶⒶⒹ again.
ⒶⒶⒺ	Flow rate assignment for 4 mA analog output *1, *6	0 to 400 % FS equiv. *5	0	The decimal point is not shown in the setting range. Depending on the model number the decimal point is added to the display. If the flow rate units are changed in function setup ⒸⒹ, set ⒶⒶⒺ again.
ⒺⒶⒶ	Event 1 instantaneous flow rate *2	0 to 400 % FS equiv. *5	0	• Setup is enabled when function setup ⒸⒹ is set to ⒹⒶ to ⒹⒺ. • The decimal point is not shown in the setting range. Depending on the model number the decimal point is added to the display.
ⒺⒶⒶⒶ	Hysteresis for event 1 *2	0 to 10 % FS (at 1 % interval)	1	• If the flow rate units are changed in function setup ⒸⒹ, set ⒺⒶⒶⒶ again.
ⒺⒶⒶⒶⒶ	ON delay for event 1 *3	0 to 60 s (at 1 s interval)	0	• If the flow rate units are changed in function setup ⒸⒹ, set ⒺⒶⒶⒶⒶ again.
ⒺⒶⒶⒶⒶⒶ	Event 2 instantaneous flow rate *2	0 to 400 % FS equiv. *5	0	• Setup is enabled when function setup ⒸⒹ is set to ⒹⒶ to ⒹⒺ. • The decimal point is not shown in the setting range. Depending on the model number the decimal point is added to the display.
ⒺⒶⒶⒶⒶⒶⒶ	Hysteresis for event 2 *2	0 to 10 % FS (at 1 % interval)	1	• If the flow rate units are changed in function setup ⒸⒹ, set ⒺⒶⒶⒶⒶⒶⒶ again.
ⒺⒶⒶⒶⒶⒶⒶⒶ	ON delay for event 2 *3	0 to 60 s (at 1 s interval)	0	• If the flow rate units are changed in function setup ⒸⒹ, set ⒺⒶⒶⒶⒶⒶⒶⒶ again.
ⒸⒻ	Output correction factor	0.100 to 2.000	1.000	Settable in increments of 0.001. This setting affects both indication and output. If it is changed, the peak value and lowest value for instantaneous flow rate are cleared.
ⒸⒻⒸⒸ	Low flow cutoff	1 to 50 % FS (at 1 % interval)	1	This setting applies to both normal flow and reverse flow.
ⒶⒶⒶⒶ	Upper limit for indication	100 to 200 % FS	200	The upper limit for indication can be set at a lower level than the maximum of 200 % FS. If the flow exceeds this upper limit, the display will show only the value specified by this setting.
ⒺⒶⒶⒶⒶ	Last 5 digits of integrated flow (event setup)	00000 to 99990	0	Settable when function setup ⒸⒹ is set to ⒹⒶ to ⒹⒺ.
ⒺⒶⒶⒶⒶⒶ	First 4 digits of integrated flow (event setup)	0000 to 9999	0	
ⒸⒹⒶⒶ	Flow rate cost multiplier *4	1.0 to 100.0	100.0	This setting is used to indicate cost in the device information display.

*1 Analog output scaling

The output current is calculated as follows:

$$\text{Output current} = \frac{(\text{Indicated flow rate} - 4 \text{ mA flow rate})}{(20 \text{ mA flow rate} - 4 \text{ mA flow rate})} \times 16 + 4 \text{ mA}$$

Where:

4 mA flow rate: Flow rate assignment for 4 mA analog output

20 mA flow rate: Flow rate assignment for 20 mA analog output

• The minimum output for reverse flow is 3.2 mA and the maximum output for normal flow is 20.8 mA.

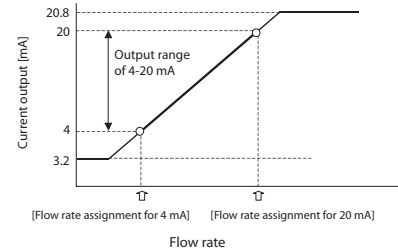

• If 4 mA flow rate ≥ 20 mA flow rate, the fixed output for alarm occurrence is output.

• If the difference between the flow rate assignments for 20 mA and for 4 mA is smaller than the full-scale flow rate, the resulting lower resolution may make it impossible to get the desired output.

*2 Event output for instantaneous flow rate

Behavior depends on the setting in function setup ⒸⒹ.

(1) When ⒸⒹ is set to ⒹⒶ or ⒹⒶ (instantaneous flow rate upper limit)

If the flow rate exceeds the instantaneous flow rate upper limit, event output turns on. The point at which event output turns off involves a hysteresis and is calculated as follows:

Event OFF point = instantaneous flow rate upper limit - hysteresis

Specify the hysteresis as a percentage of the full scale flow rate (% FS).

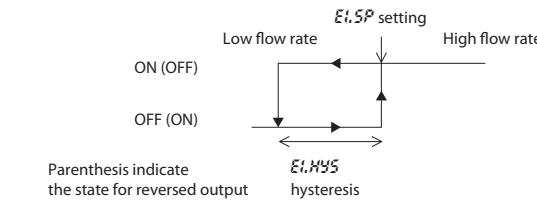

Note If the Event OFF point is less than zero, the output turns off at zero.

(2) When ⒸⒹ is set to ⒹⒶ or ⒹⒶ (instantaneous flow rate lower limit)

If the flow rate falls below the instantaneous flow rate lower limit, event output turns on. The point at which event output turns off involves a hysteresis and is calculated as follows:

Event OFF point = instantaneous flow rate lower limit + hysteresis

Specify the hysteresis as a percentage of the full scale flow rate (% FS).

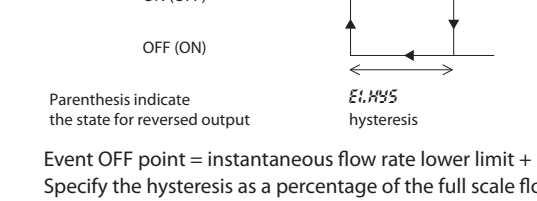

(3) When ⒸⒹ is set to ⒹⒶ or ⒹⒶ (within range for instantaneous flow rate)

When ⒺⒶⒶ > ⒺⒶⒶ, the setting for ⒺⒶⒶ is used as the upper limit and the setting for ⒺⒶⒶ is used as the lower limit. When ⒺⒶⒶ < ⒺⒶⒶ, the ⒺⒶⒶ setting is the lower limit and ⒺⒶⒶ setting is the upper limit.

When ⒺⒶⒶ = ⒺⒶⒶ, this function does not operate. Hysteresis should be set below the lower limit and above the upper limit.

Specify hysteresis as a percentage of full scale flow rate (% FS). Different hysteresis can be set for the lower limit and the upper limit.

• ⒺⒶⒶ setting < ⒺⒶⒶ setting

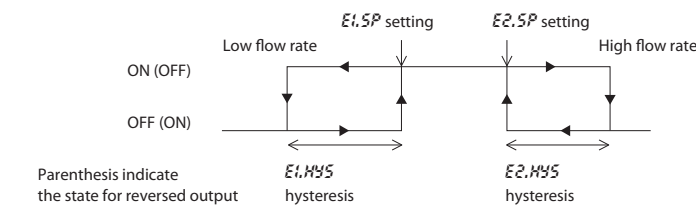

• ⒺⒶⒶ setting > ⒺⒶⒶ setting

Note If Event OFF point is less than zero, the output turns off at zero.

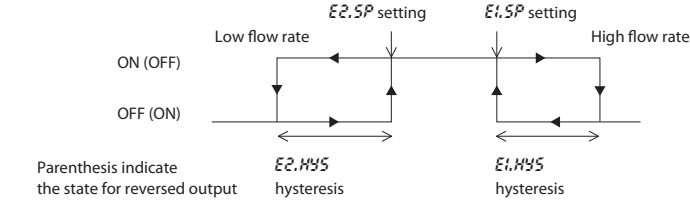

*3 Event ON delay

The event ON delay sets a delay before the event output turns on.

ⒺⒶⒶⒶ is for the setup of ⒺⒶⒶ and ⒺⒶⒶⒶ is for the setup of ⒺⒶⒶ.

*4 Flow rate cost calculation

The flow rate cost calculation is related to the setting for flow rate units in function setup ⒸⒹ.

ⒸⒹ setting	Unit of flow rate cost calculation
00: L/min, L	Per 1 m ³
01: m ³ /h, m ³	
02: m ³ /min, m ³	Per 1 kg
03: kg/h, kg	
04: CFH, CF	Per 1000 CF
05: CFM, CF	

TROUBLESHOOTING

Remedy for abnormal phenomena

Phenomenon	Remedy
The display does not indicate anything.	<ul style="list-style-type: none"> Check that the supplied power and polarity are correct. Check that the connector is connected correctly.
Shutting the front and back valves of the MCF, etc., the actual flow rate should be zero, but the flow rate display does not indicate zero.	<ul style="list-style-type: none"> Check for gas leaks Check that wiring is correct. When the MCF is mounted on a horizontal pipe and the display unit faces the side, zero point drift may be caused by the mounting direction. Set the low flow cutoff to 5 % FS. If the MCF is mounted where the ambient temperature or the temperature of the measured gas fluctuates widely, the MCF might detect convection inside the pipe as a flow. Try measuring after the temperature stabilizes.
Measurement error has increased and exceeds the accuracy specifications.	<ul style="list-style-type: none"> Check for gas leaks. Check if foreign matter is stuck on the main path orifices. If so, remove it. After detaching the measurement module from the main path, check if foreign matter is stuck on the main path orifices. If so, blow it off with compressed air. After detaching the measurement module from the main path, check if the internal filter is stained. If so, clean it. Check if foreign substances such as dust or oil are present on the pipe or the connection port of the MCF. If so, ask Azbil Corporation for repair. Check that the wiring is correct. Check if the flow fluctuates widely, or if it greatly exceeds the measurable limit.

Alarm codes and remedies

Alarm code	Item	Contents	Causes	Remedy
ⒶⒶⒶ	Flow rate range exceeded	Flow exceeds the upper limit for indication. Or, the flow exceeds the reverse flow rate range.	A forward or reverse flow exceeds the specified range.	Check for excessive flow. If a minus sign is shown on the flow rate display when the alarm occurs, there might be a reverse flow. Correct the factor causing the reverse flow. When the actual flow enters the normal range, the alarm lamp should turn off.
ⒶⒶⒶⒶ	Registered data error 1	The registered flow path identifiers are incorrect. Flow rate cannot be calculated correctly.	Wrong flow path identifiers setting.	Set the correct flow path identifiers in maintenance mode. If the MCF does not return to normal after the setting is changed, reboot it. If the MCF does not return to normal after being restarted, call for repair.
ⒶⒶⒶⒶⒶ	Registered data error 2	The registered properties of the flow sensor are incorrect. The flow rate can not be calculated correctly.	The registered properties might be corrupted.	If the MCF does not return to normal after rebooting, call for repair.
ⒶⒶⒶⒶⒶⒶ	Sensor error 1	The flow signal is outside the normal range.	The flow signal can decrease greatly if foreign matter causes a short circuit or if there is an excessive reverse flow.	If the cause of this alarm is excessive reverse flow, the MCF will return to normal automatically when the flow falls within the measurable range. If the alarm does not turn off in spite of a normal reverse flow, ask for repair.
ⒶⒶⒶⒶⒶⒶⒶ	Sensor error 2	The flow signal may differ from the actual flow.	The sensor might be broken or the output level might have decreased. Foreign matter or condensation may be present on the sensor.	If the MCF does not return to normal after a few hours of dry air flow, call for repair.
ⒶⒶⒶⒶⒶⒶⒶⒶ	Sensor error 3			
ⒶⒶⒶⒶⒶⒶⒶⒶⒶ	Sensor error 4	Sensor heater voltage is outside the normal range.	The sensor may be broken or foreign matter may be stuck to it, causing a short circuit.	If the MCF does not return to normal after a few hours, call for repair.
ⒶⒶⒶⒶⒶⒶⒶⒶⒶⒶ	Memory error	Device data error Checksum error during EEPROM read/write process.	Data might be corrupted by electrical noise.	If the MCF does not return to normal after rebooting, call for repair.
ⒶⒶⒶⒶⒶⒶⒶⒶⒶⒶⒶ	Property error			
ⒶⒶⒶⒶⒶⒶⒶⒶⒶⒶⒶⒶ	Setup data error			
ⒶⒶⒶⒶⒶⒶⒶⒶⒶⒶⒶⒶⒶ	Integrated data error			
			EEPROM write process might have ended abnormally due to power outage.	Try data setup again. If the MCF does not return to normal after rebooting, call for repair.
				After resetting the integrated flow, if the MCF does not return to normal after rebooting, call for repair.

*5 Setting range

The setting range depends on the model number and the flow rate indication units. See the table below.

ⒸⒹ setting	MCF0080	MCF0150	MCF0151	MCF0250	MCF0400	MCF0500	Notes
00: [L/min]	0 to 800	0 to 2000	0 to 4000	0 to 12000	0 to 24000	0 to 48000	The upper limit of the range corresponds to a flow rate of 400 % FS.
01: [m ³ /h]	0 to 48.0	0 to 120.0	0 to 240.0	0 to 720.0	0 to 1440.0	0 to 2880.0	
02: [m ³ /min]	0 to 0.800	0 to 2.000	0 to 4.000	0 to 12.000	0 to 24.000	0 to 48.000	
03: [kg/h]	0 to 62.1	0 to 155.2	0 to 310.4	0 to 931.0	0 to 1862.0	0 to 3724.0	The upper limit of the range corresponds to a flow rate of 200 % FS.
04: [CFH]	0 to 847	0 to 2119	0 to 4238	0 to 12710	0 to 25420	0 to 50850	
05: [CFM]	0 to 14.10	0 to 35.30	0 to 70.60	0 to 211.90	0 to 423.70	0 to 847.40	

If the setting exceeds the upper limit for indication, the instantaneous flow rate output will be equivalent to the upper limit for indication.

Do not set values for Event 1 instantaneous flow rate or Event 2 instantaneous flow rate that exceed the upper limit for indication. The instantaneous flow rate may not reach the set value, so that the event does not operate.

*6 Can be selected for 4 to 20 mA output models only.

Cannot be selected for RS-485 communications models.

MODEL SELECTION GUIDE · OPTIONAL PARTS

Model selection guide

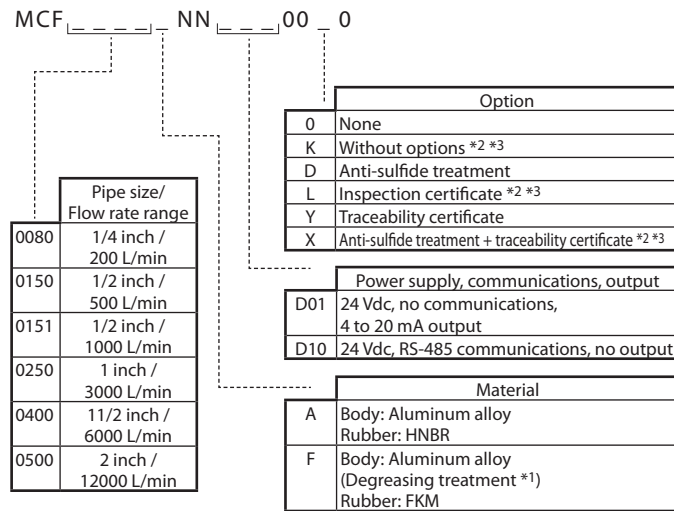

- *1 For oil-inhibiting treatment, refer to "Material and Treatments" in the specifications.
 *2 HumiSeal, manufactured by AR BROWN CO., LTD, is applied to the circuit board, with the exception of some parts that cannot be varnished due to their function, such as displays, switches, etc.
 *3 Options "K" "L" and "X" are not available for MCF _____ F models (body: aluminum alloy with oil-inhibiting treatment; rubber: FKM)

Optional parts (sold separately)

Name	Model number	Cable length	Cable properties	Lead color
Cable with connector exclusive for MCF	PA5-4ISX2SK	2 m	Oil resistant, bend-tolerant	1 - Brown
	PA5-4ISX3SK	3 m	Flame-resistant cable UL2464	2 - White
	PA5-4ISX5SK	5 m	EN-compliant	3 - Blue 4 - Black
Extension cable with connector	PA5-4ISX2HK-E	2 m	Oil resistant, Flame-resistant cable UL2464	
	PA5-4ISX3HK-E	3 m	EN-compliant	
	PA5-4ISX5HK-E	5 m	EN-compliant	

Name	Model number	Description
Mounting bracket	81446721-001	For MCF0080/0150/0151/0250
Measurement module	81441792-203	For MCF _____ ANND01 _____ (no anti-sulfide treatment if "D" or "Y")
	81441792-223	For MCF _____ ANND10 _____ (no anti-sulfide treatment if "D" or "Y")
	81441792-403	For MCF _____ FNND01 _____ (with anti-sulfide treatment if "D" or "Y")
	81441792-423	For MCF _____ FNND10 _____ (with anti-sulfide treatment if "D" or "Y")
	81441792-603	For MCF _____ ANND01 _____ (with anti-sulfide treatment if "D" or "Y")
	81441792-623	For MCF _____ ANND10 _____ (with anti-sulfide treatment if "D" or "Y")

SPECIFICATIONS

In this manual, flow rates have been converted to values at 0 °C and 101.325 kPa (abs).

Item	MCF0080	MCF0150	MCF0151	MCF0250	MCF0400	MCF0500	
Measured gas	Air/Nitrogen Gas must be dry and not contain corrosive components such as chlorine, sulfur and acid. Gas must be a clean, without dust or oil mist.						
Full scale (FS) flow rate [L/min]	200	500	1000	3000	6000	12000	
Minimum sensitivity [L/min]	2	5	10	30	60	120	
Indication resolution [L/min] *1	Instantaneous flow rate	1	1	2	10	10	
	Integrated flow	10	10	10	100	100	
Maximum display range [L/min]	-60 to +400	-150 to +1000	-300 to +2000	-900 to +6000	-1800 to +12000	-3600 to +24000	
	[m ³ /h]	-3.6 to +24.0	-9.0 to +60.0	-18.0 to +120.0	-54.0 to +360	-108.0 to +720.0	
	[m ³ /min]	-0.060 to +0.400	-0.150 to +1.000	-0.300 to +2.000	-0.900 to +6.000	-1.800 to +12.000	-3.600 to +24.000
	[kg/h]	-4.7 to +31.0	-11.6 to +77.6	-23.2 to +155.2	-70 to +465.5	-140.0 to +931.0	-279.0 to +1862.0
	[CFH]	-127 to +848	-318 to +2119	-736 to +4238	-1905 to +12715	-3810 to +25430	-7630 to +50850
Indication accuracy for instantaneous flow rate	[CFM]	-2.12 to +14.12	-5.30 to +35.30	-10.6 to +70.6	-31.5 to +211.5	-63.5 to +423.50	
		±3 % FS ±1 digit (except 2 % or less of FS flow rate) *4, *5, *6					
Indication repeatability for instantaneous flow rate	±1 % FS ±1 digit (2 to 100 % of FS flow rate)						
Temperature characteristics	±0.15 % FS / °C ±1 digit or less						
Pressure characteristics for instantaneous flow rate	Operating pressure 0 to 1 MPa	-0.25 % FS / 0.1 MPa ±1 digit or less (2 to 40 % of FS flow rate)					
	Operating pressure -0.07 to 0 MPa	-0.55 % FS / 0.1 MPa ±1 digit or less (40 to 100 % of FS flow rate)					
Pressure characteristics of instantaneous flow rate for Position 2 mounting *2	Operating pressure 0 to 1 MPa	±0.25 % FS / 0.01 MPa ±1 digit or less (2 to 40 % of FS flow rate)					
	Operating pressure -0.07 to 0 MPa	±0.55 % FS / 0.01 MPa ±1 digit or less (40 to 100 % of FS flow rate)					
Pressure characteristics of instantaneous flow rate for Position 3 mounting *3	Operating pressure 0 to 1 MPa	0.5 % FS / 0.1 MPa ±1 digit or less (5 to 100 % of FS flow rate)					
	Operating pressure -0.07 to 0 MPa	0.5 % FS / 0.01 MPa ±1 digit or less (5 to 100 % of FS flow rate)					
Operating pressure range	-0.07 to +1.0 MPa (gauge pressure)						
Operating temperature range	-10 to +60 °C (without freezing)						
Operating humidity range	0 to 90 % RH (without condensation)						
Storage temperature range	-20 to +70 °C (without freezing)						
Storage humidity range	0 to 90 % RH (without condensation)						
Pressure resistance	1.5 MPa (gauge pressure)						
Allowable leakage rate	100 mL/h (at internal pressure of 1.5 MPa)						
Connecting bore, standard	1/4 "NPT	1/2 "NPT	1/2 "NPT	1 "NPT	1 1/2 "NPT	2 "NPT	
Rated voltage	24 Vdc						
Power supply range	22.8 to 25.2 Vdc						
Current consumption	120 mA max.						
Measurement cycle	50 ±5 ms (factory setting)						
Instantaneous flow rate output (Not available for RS-485 communications models)	Current output:	4 to 20 mA (3.2 to 20.8 mA of output range)					
	Output at alarm occurrence (upper):	21.6 ±0.4 mA (factory setting, variable by function setup)					
	Output at alarm occurrence (lower):	0.0 ±0.4 mA (fixed)					
	Accuracy:	Indication for instantaneous flow rate ±0.5 % FS ±1 digit					
Response time	Allowable load resistance:	300 Ω max.					
	Maximum output current:	24 mA max.					
RS-485 communications (RS-485 communications models only)	1.5 s max. (time until 95 % of final value for response to 0 to 100 %FS step input, with 50 ms measurement cycle)						
	Transmission line:	3-wire system					
	Transmission speed:	4800, 9600, 19200 bps					
	Protocol:	MODBUS					
	Data length:	8 or 7					
	Parity bit:	None, even or odd					
	Stop bits:	1 or 2					

Item	MCF0080	MCF0150	MCF0151	MCF0250	MCF0400	MCF0500
Event output (Not available for RS-485 communications models)	NPN open collector: 30 Vdc, 50 mA max Selectable from following functions: • Instantaneous flow rate switch (upper limit, lower limit, within range) • Integrated flow switch (count-up, countdown) • Integrated pulse output (3 assignable pulse weights) • Alarm output					
Data storage	EEPROM non-volatile semiconductor memory					
Dielectric strength	1 mA or less of leak current when 500 Vac is applied for 1 s between contacts of connector and main flow path or mounting bolts.					
Insulation resistance	50 MΩ or more between contacts of connector and main flow path or mounting bolts, with 500 Vdc megger					
Protective structure	IP65 (JIS C0920 and IEC529) ingress protection for indoor installation					
Standards compliance	EN61326-2-3: 2006, EN61326-1: 2006 UL File No.E246616 (Models MCF _____ ANND010000, MCF _____ ANND0100D0, MCF _____ ANND0100Y0 are UL - certified.)					
Mass	Approx. 400 g	Approx. 400 g	Approx. 400 g	Approx. 500 g	Approx. 700 g	Approx. 1.1 kg

- *1 The indication resolution shows the smallest displayable digit, regardless of the position of the decimal point or the flow rate units.
 *2 Horizontal piping with the display facing right as seen from the air inlet (Position 2)
 *3 Horizontal piping with the display facing left as seen from the air inlet (Position 3)
 *4 Measuring accuracy becomes ±5 % FS ±1 digit after the measurement module is reassembled.
 *5 The measuring accuracy becomes ±5 % FS ±1 digit after the measurement module is replaced with a new one. (For MCF0250, MCF0400 and MCF0500)
 *6 Do not connect a carbon steel pipe for pressure service (JIS G3454) or stainless steel pipe (JIS G3459) that is larger than schedule 40. Doing so might cause a deterioration of accuracy. (If the pipe schedule number is larger, the inner pipe diameter is smaller, resulting in reduced accuracy.)

Material and Treatments

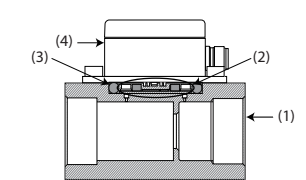

Model number	MCF _____ A _____	MCF _____ F _____
(1) Main flow path	Aluminum alloy (alumite treatment)	Aluminum alloy (alumite treatment, ultrasonic cleaning, immersed in cleaning solution)
(2) Measurement module	SUS304, PBT, HNBR, Urethane foam	SUS304 (immersion in cleaning solution), PBT, FKM, Urethane foam
(3) Packing	HNBR	FKM (immersion in cleaning solution)
(4) Measurement module electronic component case	Modified PPO	Modified PPO

EXTERNAL DIMENSIONS

MCF0080/0150/0151/0250

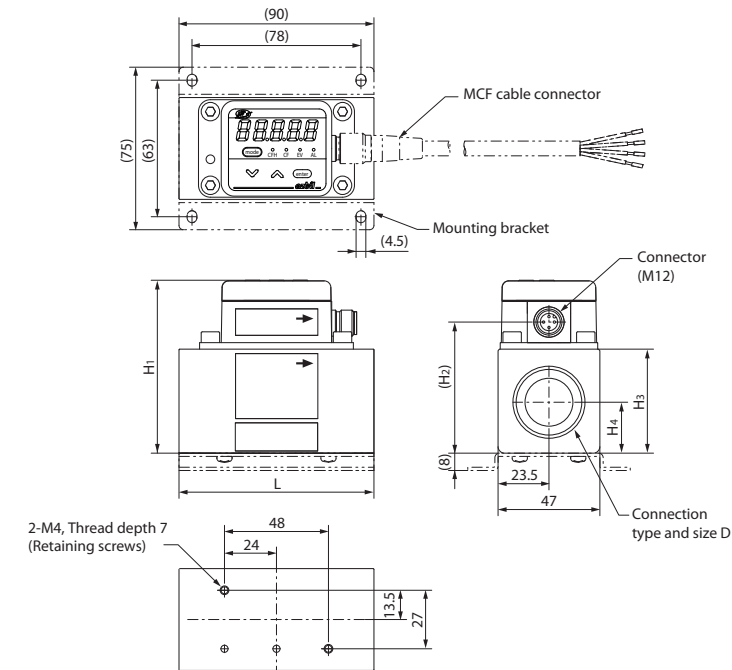

	MCF0080	MCF0150/0151	MCF0250
H ₁	65.8	65.8	79.8
H ₂	46.5	46.5	60.5
H ₃	34	34	48
H ₄	15	15	23.5
L	75	75	90
D	1/4 "NPT	1/2 "NPT	1 "NPT

MCF0400/0500

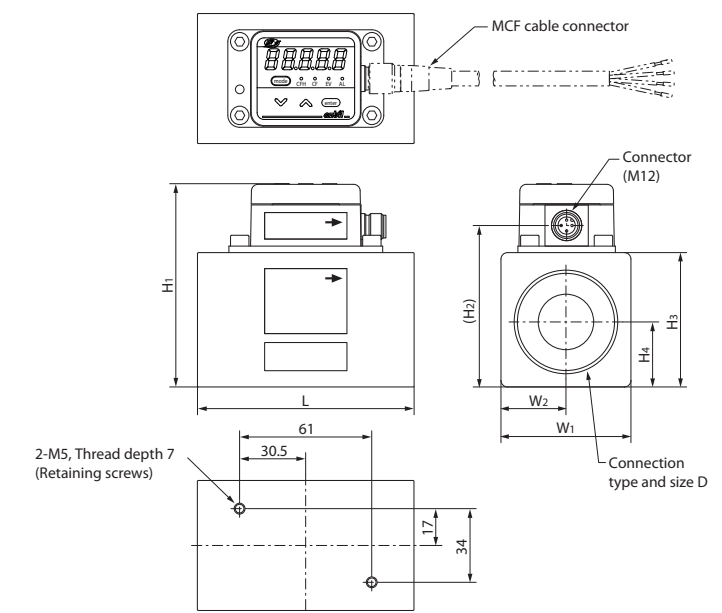

	MCF0400	MCF0500
H ₁	93.8	106.8
H ₂	74.5	87.5
H ₃	62	75
H ₄	30	37.5
L	100	110
W ₁	60	75
W ₂	30	37.5
D	1 1/2 "NPT	2 "NPT

基于SJ/T11364-2014「电子电气产品有害物质限制使用标识要求」的表示式样

产品中有毒物质的名称及含量

部件名称	有害物质					
	铅 (Pb)	汞 (Hg)	镉 (Cd)	六价铬 (Cr(VI))	多溴联苯 (PBB)	多溴二苯醚 (PBDE)
电路板	×	○	○	○	○	○
机箱	×	○	○	○	○	○

本表格依据SJ/T 11364 的规定编制。
 ○: 表示该有害物质在该部件所有均质材料中的含量均在GB/T 26572规定的限量要求以下。
 ×: 表示该有害物质至少在该部件的某一均质材料中的含量超出GB/T 26572规定的限量要求。



azbil
 Azbil Corporation
 Advanced Automation Company

1-12-2 Kawana, Fujisawa
 Kanagawa 251-8522 Japan
 URL: <http://www.azbil.com>

1st edition: Feb. 2009 (M)
 6th edition: June 2016 (V)