

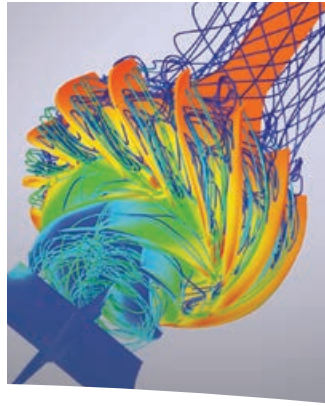

*Durco<sup>®</sup> Guardian  
ANSI Magnetic Drive Pump*



*Experience In Motion*



## ***Pump Supplier to the World***

*Flowserve is the driving force in the global industrial pump marketplace. No other pump company in the world has the depth or breadth of expertise in the successful application of pre-engineered, engineered, and special purpose pumps and systems.*

### ***Life Cycle Cost Solutions***

Flowserve provides pumping solutions that permit customers to reduce total life cycle costs and improve productivity, profitability and pumping system reliability.

### ***Market-Focused Customer Support***

Product and industry specialists develop effective proposals and solutions directed toward market and customer preferences. They offer technical advice and assistance throughout each stage of the product life cycle, beginning with the initial inquiry.

### ***Broad Product Lines***

Flowserve offers a wide range of complementary pump types, from pre-engineered process pumps to highly engineered and special purpose pumps and systems. Pumps are built to recognized global standards and customer specifications.

Pump designs include:

- Single-stage process
- Between bearings single-stage
- Between bearings multistage
- Vertical
- Submersible motor
- Positive displacement
- Nuclear
- Specialty

### ***Product Brands of Distinction***

*ACEC™ Centrifugal Pumps*

*Aldrich™ Pumps*

*Byron Jackson® Pumps*

*Calder™ Energy Recovery Devices*

*Cameron™ Pumps*

*Durco® Process Pumps*

*Flowserve® Pumps*

*IDP® Pumps*

*INNOMAG® Sealless Pumps*

*Lawrence Pumps®*

*Niigata Worthington™ Pumps*

*Pacific® Pumps*

*Pleuger® Pumps*

*Scienco™ Pumps*

*Sier-Bath® Rotary Pumps*

*TKL™ Pumps*

*United Centrifugal® Pumps*

*Western Land Roller™ Irrigation Pumps*

*Wilson-Snyder® Pumps*

*Worthington® Pumps*

*Worthington Simpson™ Pumps*

**Durco Guardian  
ASME (ANSI)  
Magnetic Drive  
Pump**

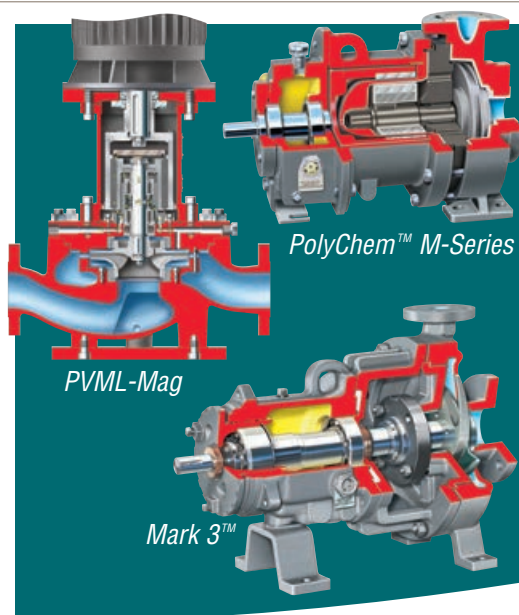

## A Leader in Sealless Pump Technology

Flowserve Durco Guardian sealless pump technology offers superior, leak-free performance in the most demanding services. Compliant with ASME (ANSI) B73.1-2001 dimensional standards, the Guardian magnetic drive pump is designed for simplicity and reliability in even the toughest emission-free services.

### Reliability and Performance

The Guardian magnetic drive pump possesses numerous reliability and performance enhancing features, including:

- Rugged silicon carbide bushings and journals
- Proven Mark 3 casing and impeller
- Optimized internal lubrication path

### Broad Applications

- Acid transfer
- Aquariums
- Chlor-alkali
- Corrosive services
- Difficult-to-seal liquids
- Flammable liquids
- Organic chemicals
- Polymers
- Solvents
- Toxic services
- Ultrapure liquids
- Valuable liquids
- Water treatment

### Complementary Pump Designs

In addition to the Guardian magnetic drive pump, Flowserve also can provide the following pump designs:

- Mark 3 ASME (ANSI) standard, chemical process pump
- Mark 3 ISO standard, chemical process pump
- CPXS ISO magnetic drive, chemical process pump
- PVML-Mag API vertical in-line, magnetic drive pump
- PolyChem M-Series ASME (ANSI) non-metallic, magnetic drive pump
- ERPN-Mag magnetic drive process pump



*Durco Guardian  
ASME (ANSI)  
Magnetic Drive  
Pump*

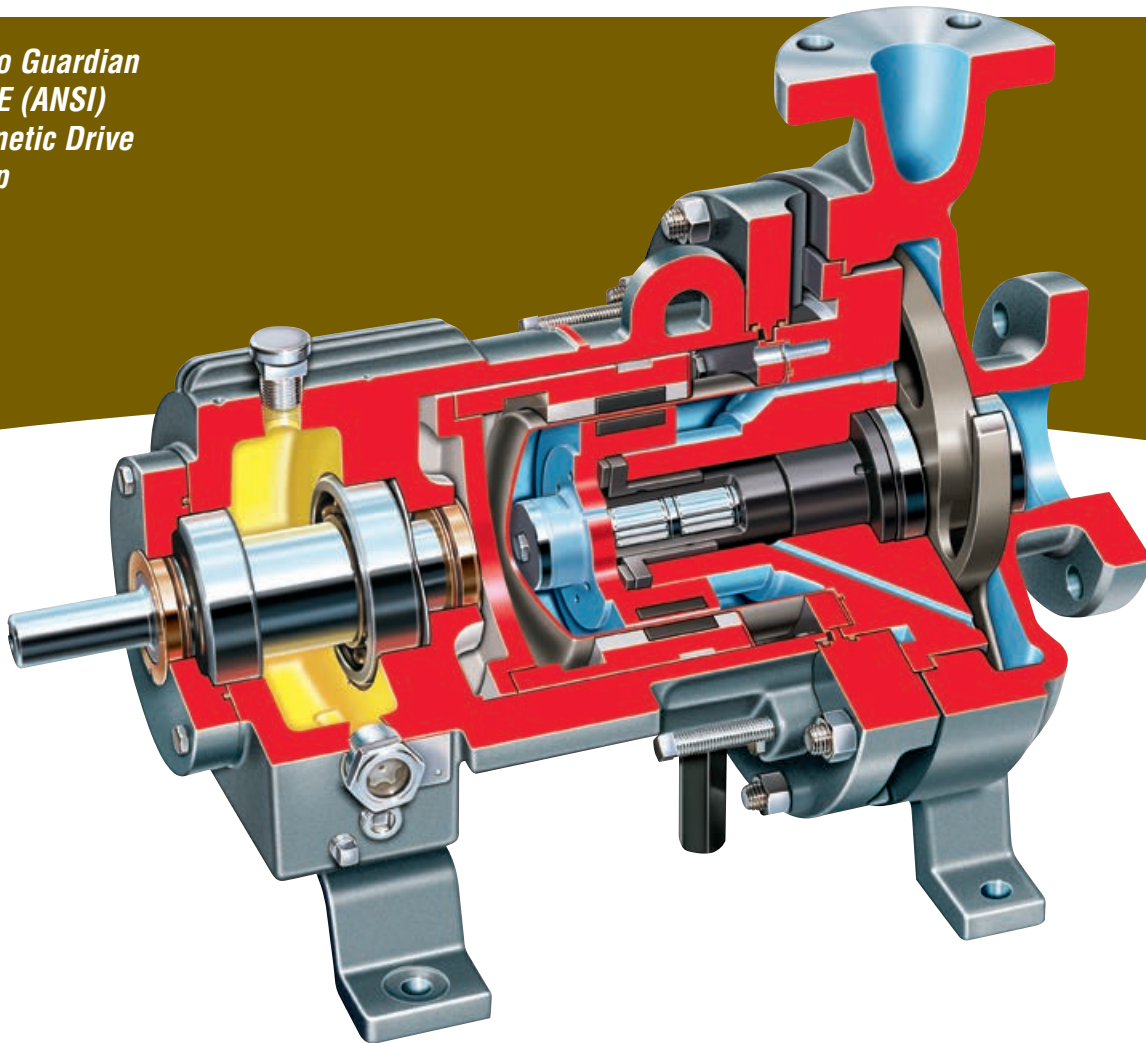

*The Flowserve Durco Guardian is a horizontal, magnetic drive pump designed for simplicity and reliability in emission-free services. It is compliant with ASME (ANSI) B73.1-2001 dimensional standards, ASME (ANSI) B73.3-2003 sealless pump standards and HI 5.1-5.6 1992 standards.*

Available in 18 sizes, the Guardian uses the same casing and reverse vane impeller as the Flowserve Durco Mark 3 ASME (ANSI) standard pump. This interchangeability of wet end parts provides consistent hydraulic performance and allows pumps to easily be converted from sealed to sealless configurations.

### **Operating Parameters**

- Flows to 375 m<sup>3</sup>/h (1650 gpm)
- Heads to 215 m (700 ft)
- Pressures to 24 bar (350 psi)
- Temperatures to 290°C (550°F)
- Motor sizes to 93 kW (125 hp) at 60 Hz

**Exclusive Reverse Vane Impeller** provides constant inner bearing lubrication, predictable thrust characteristics and lowest average NPSHR.

**Hastelloy® C-276 Containment Shell** provides excellent corrosion resistance and meets Section VIII of the ASME Pressure Vessel Code.

**Samarium Cobalt Rare Earth Magnets** in synchronous drive design eliminate slippage and permit high-temperature application.

**Silicon Carbide Bushings and Journals** resist wear and corrosion. Optional materials are available for special application needs.

**Precise Running Clearances** protect the containment shell from potential damage.

**Jackbolts** offer added safety and facilitate maintenance.

© Hastelloy is a registered trademark of Haynes International, Inc.

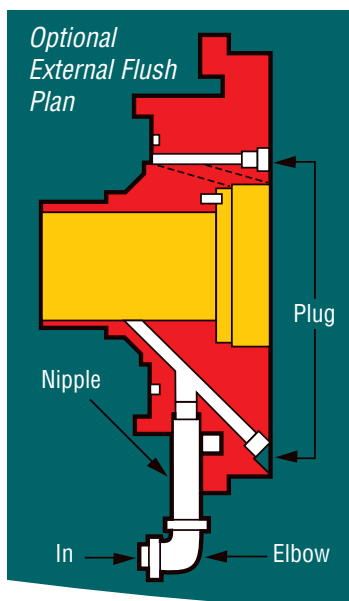
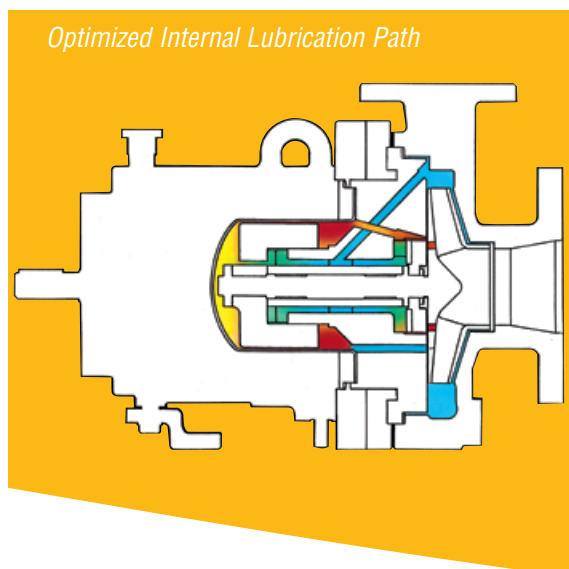

### **Optimized Internal Lubrication Path for Superior Cooling and Performance**

The Durco Guardian magnetic drive pump features a highly engineered internal lubrication path designed to deliver superior cooling and efficient pump performance. By introducing the coolest possible fluid to the bushings and journals, the Guardian achieves optimum lubrication, cooling and performance.

First, high-pressure process fluid is introduced to the silicon carbide bushings and journals via injection ports near the impeller discharge. Spiral and radial grooves on the bushings facilitate proper lubrication of the components. Then pressure forces the fluid into the gap between the inner magnet and the containment shell, where it dissipates heat generated by eddy currents. Finally, fluid enters the lower pressure region behind the impeller via return ports.

### **High-Temperature Design**

The Guardian is capable of handling service temperatures to 290°C (550°F). Stationary silicon carbide bushings are cartridge mounted using tolerance rings to compensate for thermal expansion. O-rings protect tolerance rings from corrosion. Cartridges are pre-assembled at the factory and slip-fit into the bearing holder.



### **Available External Flush Plan**

An external flush plan is available with the Guardian to extend the pump's application range. By introducing a clean, compatible flush fluid or a filtered bypass flush into the containment shell area, the Guardian can handle otherwise difficult process conditions.

### **Standard and Contained Back Pullout**

The Guardian offers end users the convenience and safety of standard and contained back pullout.

- Standard back pullout facilitates general maintenance and inspection. The casing stays in-line and the piping connections remain intact.
- Contained back pullout facilitates drive end maintenance. The process fluid remains fully confined, thereby eliminating the need to drain or purge the pump. Furthermore, maintenance personnel are safe from exposure to potentially harmful process fluids.

#### **Standard Back Pullout**



#### **Contained Back Pullout**



**Options and Technical Data**

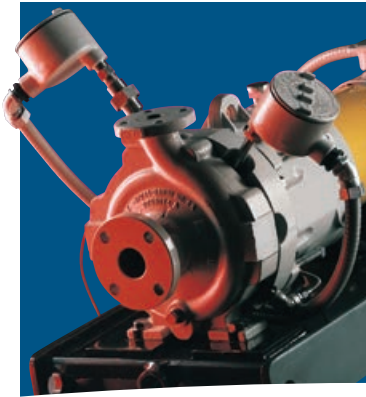

**Instrumentation Options**

- Fiber-optic leak detection
- Containment shell temperature probe
- Process temperature probe
- Pressure transducers
- Flow switches
- Vibration probes

**Other Options**

- Close-coupled configuration
- Self-priming configuration
- Labyrinth oil seals
- KW941 Pump Power Monitor

**Materials of Construction**

The Guardian is available in a wide range of materials to suit application needs. The accompanying chart lists the most common materials of construction.

Guardian Alloy Code	Specification
D4 (316SS)	ASTM A744, Gr. CF8M
D20 (Alloy 20)	ASTM A744, Gr. CN7M
DC3 (Hastelloy C)	ASTM A494, Gr. CW6M

Alternate materials of construction such as titanium and Hastelloy B-2 can be supplied for special application needs.

**Guardian Range Chart**

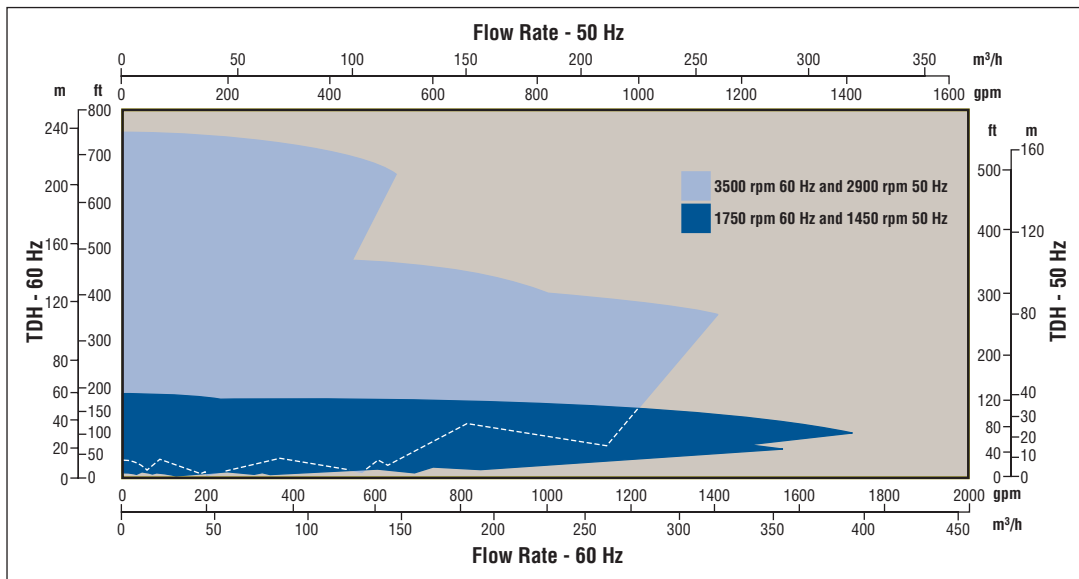

**Global Service  
and Technical  
Support**



## Life Cycle Cost Solutions

Typically, 90% of the total life cycle cost (LCC) of a pumping system is accumulated after the equipment is purchased and installed. Flowserve has developed a comprehensive suite of solutions aimed at providing customers with unprecedented value and cost savings throughout the life span of the pumping system. These solutions account for every facet of life cycle cost, including:

### Capital Expenses

- Initial purchase
- Installation

### Operating Expenses

- Energy consumption
- Maintenance
- Production losses
- Environmental
- Inventory
- Operating
- Removal

### Innovative Life Cycle Cost Solutions

- New Pump Selection
- Turnkey Engineering and Field Service
- Energy Management
- Pump Availability
- Proactive Maintenance
- Inventory Management

### Typical Pump Life Cycle Costs<sup>1</sup>

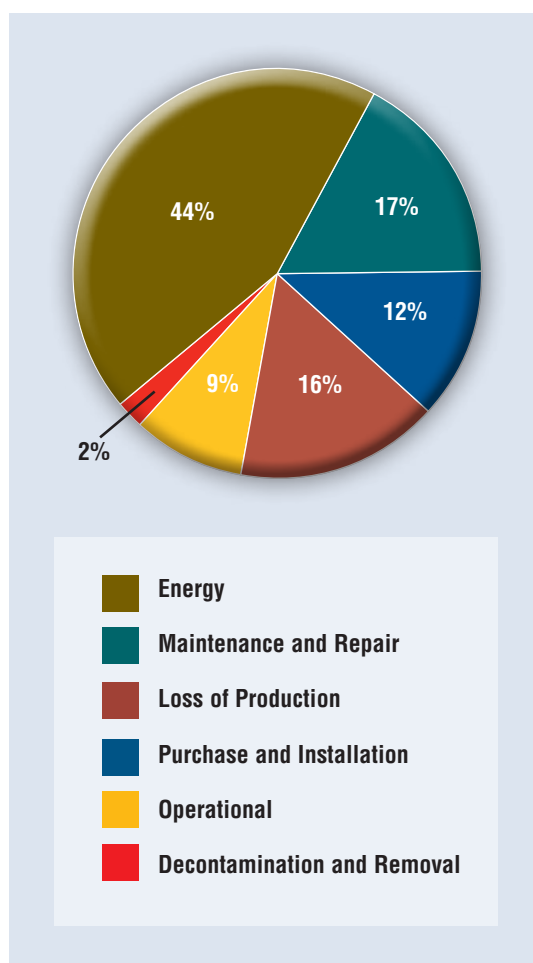

<sup>1</sup> While exact values may differ, these percentages are consistent with those published by leading pump manufacturers and end users, as well as industry associations and government agencies worldwide.

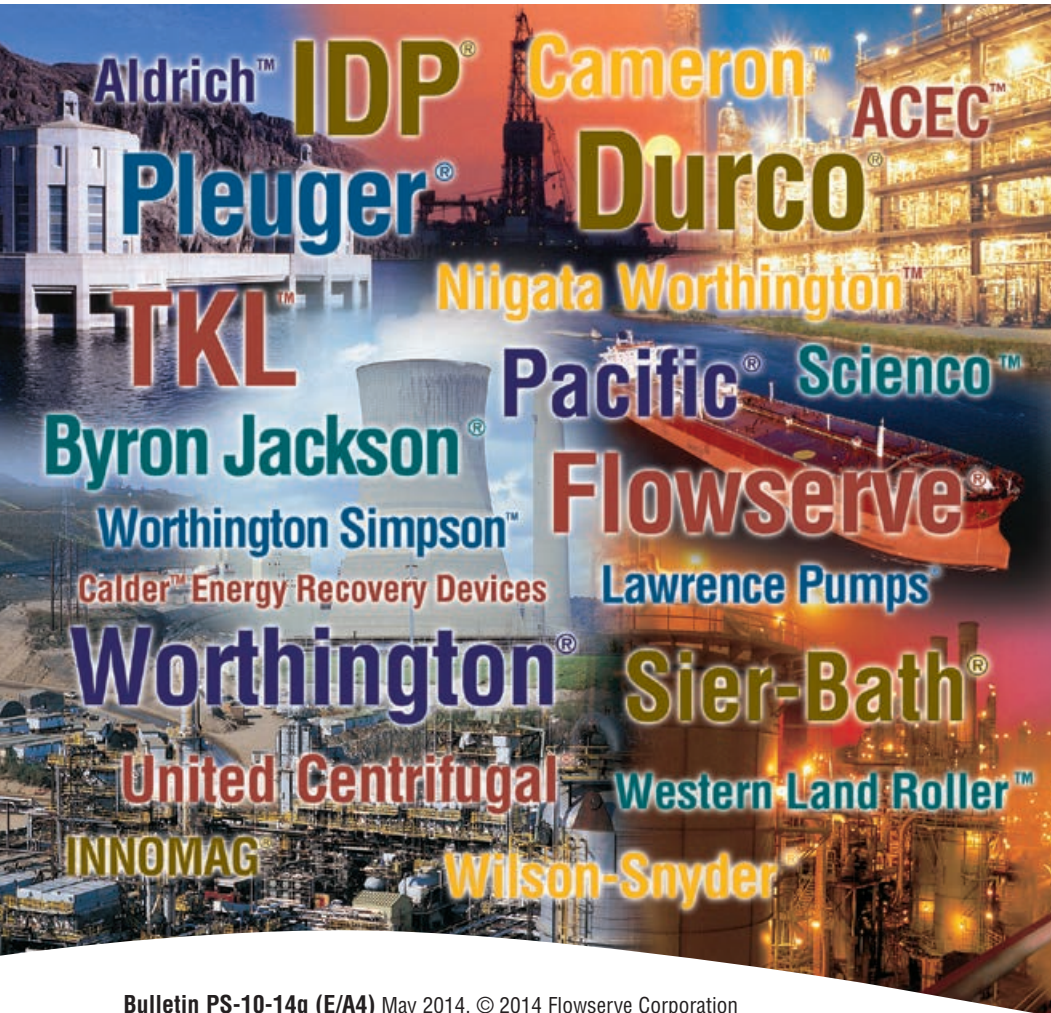

**USA and Canada**

Flowserve Corporation  
5215 North O'Connor Blvd.  
Suite 2300  
Irving, Texas 75039-5421 USA  
Telephone: +1 937 890 5839

**Europe, Middle East, Africa**

Flowserve Corporation  
Parallelweg 13  
4878 AH Etten-Leur  
The Netherlands  
Telephone: +31 76 502 8100

**Latin America**

Flowserve Corporation  
Martín Rodríguez 4460  
B1644CGN-Victoria-San Fernando  
Buenos Aires, Argentina  
Telephone: +54 11 4006 8700  
Telefax: +54 11 4714 1610

**Asia Pacific**

Flowserve Pte. Ltd.  
10 Tuas Loop  
Singapore 637345  
Telephone: +65 6771 0600  
Telefax: +65 6862 2329

Bulletin PS-10-14g (E/A4) May 2014. © 2014 Flowserve Corporation

***To find your local Flowserve representative:***

For more information about Flowserve Corporation,  
visit [www.flowserve.com](http://www.flowserve.com) or call +1 937 890 5839.