



MPC9500/0002/0005/0020
Panel Mount
Mass Flow Controller
User's Manual
for
Installation and configuration



Thank you for purchasing this product.

This manual contains information for ensuring correct use of the product. It also provides necessary information for installation, maintenance, and troubleshooting.

This manual should be read by those who design and maintain devices that use the product.

Be sure to keep this manual nearby for handy reference.

Azbil Corporation

NOTICE

Be sure that the user receives this manual before the product is used.

Copying or duplicating this user's manual in part or in whole is forbidden. The information and specifications in this manual are subject to change without notice.

Considerable effort has been made to ensure that this manual is free from inaccuracies and omissions. If you should find an error or omission, please contact the azbil Group.

In no event is Azbil Corporation liable to anyone for any indirect, special or consequential damages as a result of using this product.

© 2004-2013 Azbil Corporation All Rights Reserved.

The μF^{TM} is a trademark of Azbil Corporation in Japan.

Micro Flow SensorTM and MPCTM are trademarks of Azbil Corporation.

Conventions Used in This Manual

- To prevent injury to the operator and others, and to prevent property damage, the following types of safety precautions are indicated:



Warnings are indicated when mishandling this product might result in death or serious injury.



Cautions are indicated when mishandling this product might result in minor injury to the user, or physical damage to the product.

- In describing the product, this manual uses the icons and conventions listed below.



Use caution when handling the product.



The indicated action is prohibited.



Be sure to follow the indicated instructions.

Handling Precautions:

Handling Precautions indicate items that the user should pay attention to when handling the MPC.



Note:

Notes indicate information that might benefit the user.



This indicates the item or page that the user is requested to refer to.

(1), (2), (3)

The numbers with the parenthesis indicate steps in a sequence or indicate corresponding parts in an explanation.

>>

This indicates the contents shown on the personal computer or unit as a result of operation or unit status after completion of operation.

OFF

This indicates 7-segment indication on the setup display.

"OK" lamp

This indicates an LED lamp on the setup display.

[ENT] key



This indicates a key on the setup display.

Safety Precautions







Safety precautions are intended to ensure the safe and correct use of this product, to prevent injury to the operator and others, and to prevent damage to property. Be sure to observe these safety precautions. Please make sure you understand the safety guidelines before reading the rest of this manual.

The use of this product in a manner not specified by the manufacturer will impair its built-in safety features.

WARNING

- | | |
|---|--|
|  | Never allow gases that are within explosive limits to pass through this controller. Doing so might result in explosion accidents. |
|  | Do not use this controller for gases other than standard compatible gas types (Air/Nitrogen, argon and carbon dioxide (CO ₂)). |
|  | Do not use this device for medical instruments. |

CAUTION

- | | |
|---|--|
|  | Prevent foreign matter from entering the controller.
If the rust, water droplet, oil mist or dust in the piping flows into the controller, measurement error might occur and result in damaging the controller. If there is a possibility that any foreign matter flows into the controller, provide a filter or mist trap capable of eliminating more than 0.1 μm foreign matter at the upstream, and periodically inspect and replace the filter. |
|  | Use this controller within the operating differential pressure range. Also, do not apply pressure outside the pressure resistance range.
Doing so might damage this controller. |
|  | The valve on this device cannot completely stop a flow.
If complete shutoff is required, provide a separate shutoff valve.
Also, if an external shutoff valve is closed, it is necessary also to fully close this device's valve using either of the following methods: <ul style="list-style-type: none">• Set the flow rate to zero.• Set the operation mode to fully closed. If this valve remains in control mode when the external shutoff valve is closed (zero flow rate), there will be an excessively large momentary flow when the external shutoff valve is opened. Also, in control mode or with the valve forced fully open, if the external shutoff valve is closed continuously, the MPC's overheating prevention limit ($\overline{I_{L7}}$) will be activated and the electrical current driving the valve will be forcibly limited. |
|  | When this controller is mounted on a panel, use piping which does not give stress to the controller case during and after the piping work. If a metal piping is directly connected to the pipe connection port of this controller, the case might be deformed or damaged. |
|  | The power supply circuit of this controller and the I/O circuit are not isolated each other. Therefore, ensure that the power supply of this controller is isolated from the power supply for external devices (insulate the power supply). If a common power supply is used for the controller and the external devices, it might cause malfunction or faulty operation. |
|  | Do not allow lead clippings, chips or water to enter this controller case.
Failure to do so might cause malfunction or faulty operation. |

 **CAUTION**

For the model with analog I/O function, do not apply a negative-voltage or large voltage more than 5 V to the analog setting input terminal. Doing so might cause malfunction or faulty operation.



This device is a precision instrument. Do not drop it nor subject it to shock. Doing so might damage the device.



Be sure to check that the wiring is correct before you turn the power ON. Incorrect wiring might cause damage or malfunction.



If there is a risk of a power surge caused by lightning, use a surge absorber (surge protector) to prevent fire or device failure.

The Role of This Manual

A total of 3 different manuals are available for the Panel Mount Mass Flow Controller MPC. Read them as necessary for your specific requirements. If a manual you require is not available, contact the azbil Group or its dealer.

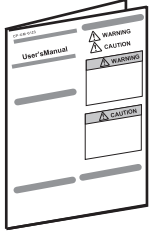

MPC 9500/0002/0005/0020 Panel-Mount Mass Flow Controller User's Manual Manual No. CP-SP-5317E

This manual is supplied with the product. Personnel in charge of design and/or manufacture of a system using this device must thoroughly read this manual. This manual describes the safety precautions, installation, wiring, and primary specifications. For further information about operation, refer to other manuals, "Installation".

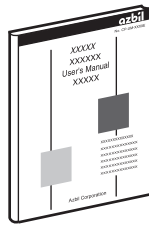

MPC9500/0002/0005/0020 Panel Mount Mass Flow Controller User's Manual for Installation and configuration

Manual No. CP-SP-1153E

This manual. This manual is optional (sold separately). Personnel in charge of design, manufacture, operation, and/or maintenance of a system using this device must thoroughly read this manual. This manual describes the installation, wiring, major functions and settings, operating procedures, troubleshooting, and detailed specifications.

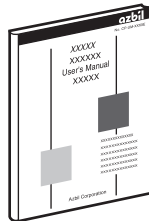

MPC9500/0002/0005/0020 Panel Mount Mass Flow Controller User's Manual for Communication Functions

Manual No. CP-SP-1154E

Those using the communications functions of the MPC should read this manual. This manual describes an outline of communications, wiring, communications procedures, a list of MPC communications data, how to remedy trouble, and communications specifications.

Organization of This User's Manual

This manual is organized as follows:

Chapter 1. INTRODUCTION

This chapter briefly describes this device, its features and the model selection guide.

Chapter 2. NAMES AND FUNCTIONS OF PARTS

This chapter describes the Names and functions of parts on this device.

Chapter 3. MOUNTING AND WIRING

This chapter describes installation, mounting, wiring and initial settings on this device.

Chapter 4. BASIC OPERATION

This chapter describes the basic operations for using this device.

Chapter 5. ADVANCED OPERATION

This chapter describes how to set the functions and parameters on this device.

Chapter 6. TROUBLESHOOTING

This chapter describes how to investigate and remedy trouble that may occur during operation of this device.

Chapter 7. SPECIFICATIONS

This chapter describes the specifications and external dimensions of this device.

Contents

Conventions Used in This Manual	
Safety Precautions	
The Role of This Manual	
Organization of This User's Manual	

Chapter 1. INTRODUCTION

■ Introduction	1-1
■ Functions.....	1-1
■ Model selection guide	1-4

Chapter 2. NAMES AND FUNCTIONS OF PARTS

■ Display	2-1
-----------------	-----

Chapter 3. MOUNTING AND WIRING

■ Mounting.....	3-2
■ Wiring.....	3-6

Chapter 4. BASIC OPERATION

4 - 1	Switching Displays.....	4-1
4 - 2	Setting the Flowrate	4-3
	■ Procedure for changing flowrate in digital setting	4-3
	■ Procedure for changing flowrate in analog setting (a model with analog input / output function)	4-5
4 - 3	Selecting the Operating Mode.....	4-6

Chapter 5. ADVANCED OPERATION

5 - 1	Function Setup	5-2
	■ Function setup item list.....	5-3
5 - 2	Parameter Setup	5-6
	■ Setup method	5-6

Chapter 6. TROUBLESHOOTING

■ Alarm code display	6-1
■ Other troubles	6-2

Chapter 7. SPECIFICATIONS

■ Specifications.....	7-1
■ Relationship between flowrate and differential pressure with valve fully opened (in air) ..	7-6

Chapter 1. INTRODUCTION

■ Introduction

The MPC high performance digital mass flow controller has been developed for the general industrial market featuring high speed and wide range flowrate control, the following features are offered:

- The MPC integrates the advanced technologies of an ultra high speed response flow velocity sensor, the μF (Micro Flow) sensor made using Azbil Corporation proprietary technology, an ultra compact proportional solenoid valve, a new flow channel structure and advanced actuator control technology achieves the realization of the mass flow controller, which can be mounted on the panel of the equipments.
- This is a compact (48 X 48 mm mask size) and light weight (approx. 300 g) mass flow controller.
- Easy operation and easy mounting can be realized in good harmony when replacing from a float type flow meter. In addition, the automatic control of mass flow rate and remote flow setting change can be performed.
- There is almost no influence of temperature and pressure fluctuations by integrating a μF sensor.
- A wide variety of functions are provided as a standard function to respond to the various needs of the users.
- In case of a float type flow meter, the pressure and temperature compensation is inevitable. In addition, if the design conditions (gas specific gravity, secondary back pressure, etc.) are different from the conditions for use, the reading value is required to convert by a specific calculation formula. However, these inconvenient operation is no more required with the mass flow control.

■ Functions

- Multi-setup function
Up to four preset flowrate settings can be instantaneously switched to by key operation or external switching input.
- Gas type switching function
The gas type to be used can be selected from the standard compatible gases by key operation.
- Gas type setting function
The user can set any gas type conversion factors to accommodate the gases other than standard compatible gases or mixed gases.
- Valve forced open/close function (selecting the operation mode)
The valve can be forcibly fully opened or fully closed by key operation or external switching input.
- Slow start function
Sudden changes in the control flowrate, when control is started or when the flowrate setting value is changed, can be suppressed.
The control speed can be changed in eight stages within the range from about 1 to 6 seconds.

- Flowrate integration function

The flowrate can be integrated up to eight digits (99,999,999 count).
(The display is switched in four digits at a time.)

MPC9500: 0.01 L in unit

MPC0002/0005: 0.1 L in unit

MPC0020: 1 L in unit

The count can be reset by key operation or external switching input.

Integration start/stop/reset can be remote-controlled by external switching input.

After a reset by key operation, the integration calculation is started automatically.

However, if a reset (contact ON) is carried out by external switching input, integration is resumed by the contact turning OFF.

- Valve drive output display

The valve drive output value can be displayed in the unit of 0.0 to 100.0 %.

The increase or decrease of supply pressure and the choking of piping can be detected.

- Alarm display/output/shut-off

The flowrate deviation alarm can be output by detecting the deviation between setting flowrate and control flowrate. The alarm judgment delay time can also be set. When a flowrate alarm occurs or an alarm occurs during controller self-diagnostics, the event signal is output, the valve can be forcibly fully closed or fully opened at your choice also.

- Event lamp light up/output

Two of the following event types can be output:

- Alarm output (When the flowrate deviation alarm or self-diagnostics occurs.)
- Flowrate upper/lower limit output (Output by comparison to the optional upper/lower flowrate limit setting value.)
- Integration count up output (When the integration setting flowrate is exceeded.)
- Integration pulse output (Pulse can be output for each integration display unit.)
- OK output (When the control flowrate is within the "set point \pm allowable range".)
- The operating mode can be identified and output externally as an event.

The output ON delay time can also be set. However, the delay cannot be set to integration pulse output. In addition, the output logic can be reversed (at normal state: ON, at event occurrence: OFF). However, the output is always OFF during power OFF.

- "OK" lamp light up / output

The "OK" lamp can be made to light when the control flowrate is within the "setting value \pm allowable range". This function is very handy for verifying at a glance whether or not the new setting value is being followed properly when a setting value is changed. The "OK" lamp output can also be used as an interlock signal for subsequent processes by assigning it to event output and loading it to a sequence program.

- Automatic shut-off function

The valve can be shut off automatically under the following conditions:

- (1) When the integration count value reaches the setting value.
- (2) When one of the alarms, including flowrate alarms, occurs.

However, the valve of this device does not have a capability of complete shut-off. When the complete shut-off is required, provide a separate shut-off valve externally.

- Automatic reset of integration count at start of control function

Start of control and integration count reset can be carried out simultaneously by a single action (key operation or external switching input). Combining this function with the automatic shut-off function described above is handy for shutting the valve off when a fixed number of integration values have been counted repeatedly.

- Direct setup function

This function allows users to easily change the flowrate setup.

This function is useful when you frequently change setting values, for example, when you adjust the preset flowrate during trial operation.

- Loader communication function

Connecting a loader cable (sold separately) to the loader jack at the rear side of this device enables direct communication with a personal computer in the form of one to one using the communication program made by user. By using this loader communication, various settings in the function setup and the flowrate setup can be configured from a personal computer, and the control flowrate or alarm status can be read out with the personal computer.

■ Model selection guide

Basic model No.	Control flow range	Display	Material	Connection	Gas type	No use	Option 1	Option 2	Option 3	Option 4	Code	Description	
MPC												Panel mount mass flow controller	
	9500											0.020 to 0.500 L/min(standard) *1	
	0002											0.08 to 2.00 L/min(standard) *1	
	0005											0.10 to 5.00 L/min(standard) *1	
	0020											0.4 to 20.0 L/min(standard) *1	
		B										Model with integrated display	
			B									Brass	
				R								Rc1/8	
					N							Air/Nitrogen *2	
						0						-	
							0					None	
								1				With analog input/output function (without RS-485 communication function)	
									2			With RS-485 communication function (without analog input/output function)	
										0		Without optional function	
											0	Without optional function	
												0	Without optional function
												D	Inspection certificate
												Y	Traceability certification
												0	Product version

*1 L/min(standard) indicates the volume flowrate per minute (L/min) converted to 20 °C, and 101.325 kPa (1 atm). The reference temperature can also be changed to 0 °C, 25 °C and 35 °C.

*2 The Air/Nitrogen is set as a factory setting. The MPC can be used for argon and carbon dioxide (CO₂) by setup change.

Chapter 2. NAMES AND FUNCTIONS OF PARTS

■ Display

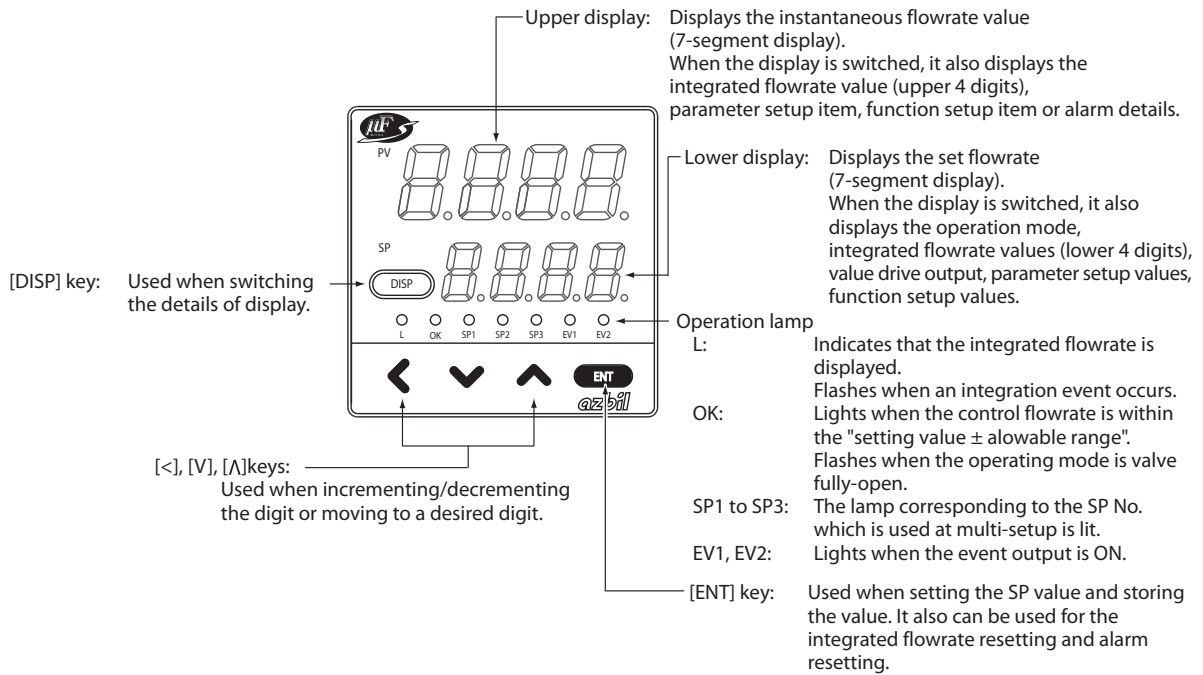

Note

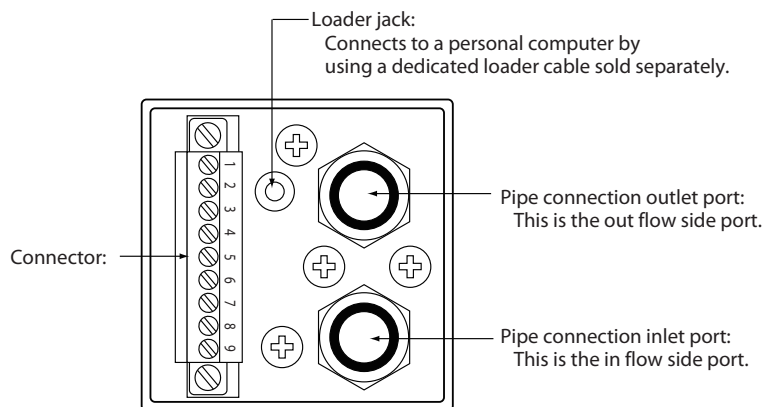

- The definition of the terms used in this manual is as follows:
 SP (Set Point): Set flowrate value
 PV (Process Variable): Instantaneous flowrate value (control flowrate)
 Operation mode: 3 mode of "valve fully-closed / valve control / valve fully-open"

● Rear view













Chapter 3. MOUNTING AND WIRING

WARNING

-  Never allow gases that are within explosive limits to pass through this controller. Doing so might result in explosion accidents.
-  Do not use this controller for gases other than standard compatible gas types (Air/Nitrogen, argon and carbon dioxide (CO₂)).

CAUTION

-  Prevent foreign matter from entering the controller.
If the rust, water droplet, oil mist or dust in the piping flows into the controller, measurement error might occur and result in damaging the controller. If there is a possibility that are any foreign matter flows into the controller, provide a filter or mist trap capable of eliminating more than 0.1 μm foreign matter at the upstream, and periodically inspect and replace the filter.
-  Use this controller within the operating differential pressure range. Also, do not apply pressure outside the pressure resistance range.
Doing so might damage this controller.
-  The valve on this device cannot completely stop a flow.
If complete shutoff is required, provide a separate shutoff valve.
Also, if an external shutoff valve is closed, it is necessary also to fully close this device's valve using either of the following methods:
 - Set the flow rate to zero.
 - Set the operation mode to fully closed.If this valve remains in control mode when the external shutoff valve is closed (zero flow rate), there will be an excessively large momentary flow when the external shutoff valve is opened.
Also, in control mode or with the valve forced fully open, if the external shutoff valve is closed continuously, the MPC's overheating prevention limit (PL7) will be activated and the electrical current driving the valve will be forcibly limited.
-  When this controller is mounted on a panel, use piping which does not give stress to the controller case during and after the piping work. If a metal piping is directly connected to the pipe connection port of this controller, the case might be deformed or damaged.
-  Do not allow lead clippings, chips or water to enter this controller case.
Failure to do so might cause malfunction or faulty operation.
-  The part between the power supply circuit of this controller and the I/O circuit is not isolated.
Therefore, ensure that the power supply of this controller is isolated from the power supply for external devices (insulate the power supply). If a common power supply is used for the controller and the external devices, it might cause malfunction or faulty operation.
-  For the model with analog I/O function, do not apply a negative-voltage or large voltage more than 5 V to the analog setting input terminal.
Doing so might cause malfunction or faulty operation.
-  This device is a precision instrument. Do not drop it nor subject it to shock. Doing so might damage the device.
-  Be sure to check that the wiring is correct before you turn the power ON.
Incorrect wiring might cause damage or malfunction.
-  If there is a risk of a power surge caused by lightning, use a surge absorber (surge protector) to prevent fire or device failure.

■ Mounting

Avoid mounting this controller in the following locations:

- Locations subject to high and low temperature and humidity
- Locations subject to sudden changes in temperature and condensation
- Locations subject to be filled with corrosive gases and flammable gases
- Locations whose atmospheres contain large amounts of dirt and dust, salt, conductive substances such as iron powder, water droplets, oil mist and organic solvents
- Locations directly subject to mechanical vibration or shock
- Locations subject to direct sunlight and rain
- Locations subject to splashing of oil or chemicals
- Locations close to sources of electrical noise
- Locations where strong magnetic or electrical fields are generated

● Joint connection

- Connect the joint by holding the hexagonal section of the pipe connection port of the body with a spanner (or wrench).

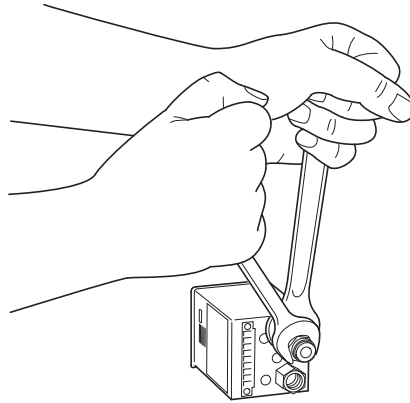
**! Handling Precautions**

- Do not hold the case of the controller with your hand when screwing the joint into the connection port. Doing so might deform the body.

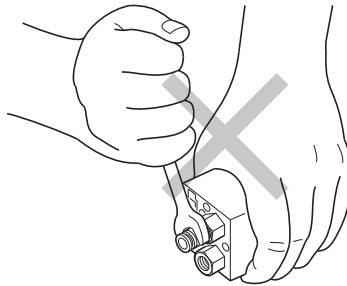

- Screw the joint with an appropriate torque as recommended by the joint manufacturer. Exceeding the torque limits will cause damage the connection port.
- Apply appropriate amount of sealant. Do not coat the top most thread of the screw. Remove any dirt or burrs from inside the joint.

Good example



Bad example

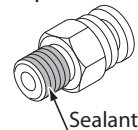

● External dimensions

unit: mm

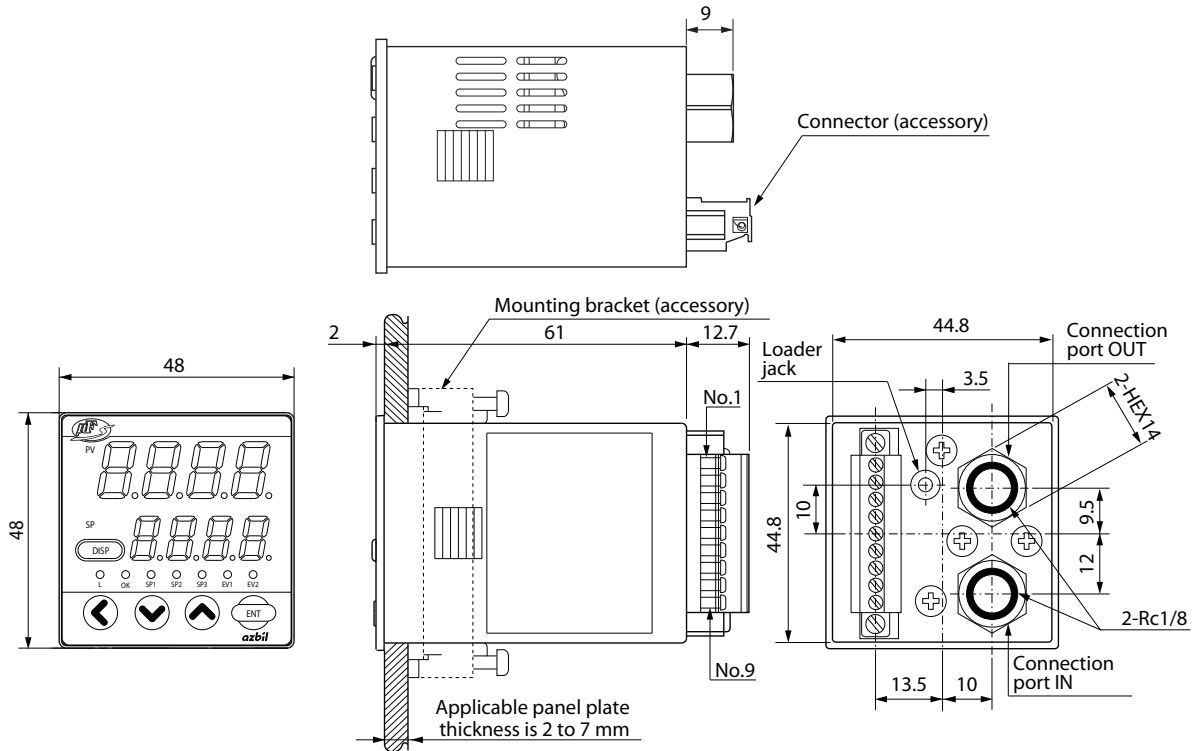

● Panel cutout

unit: mm

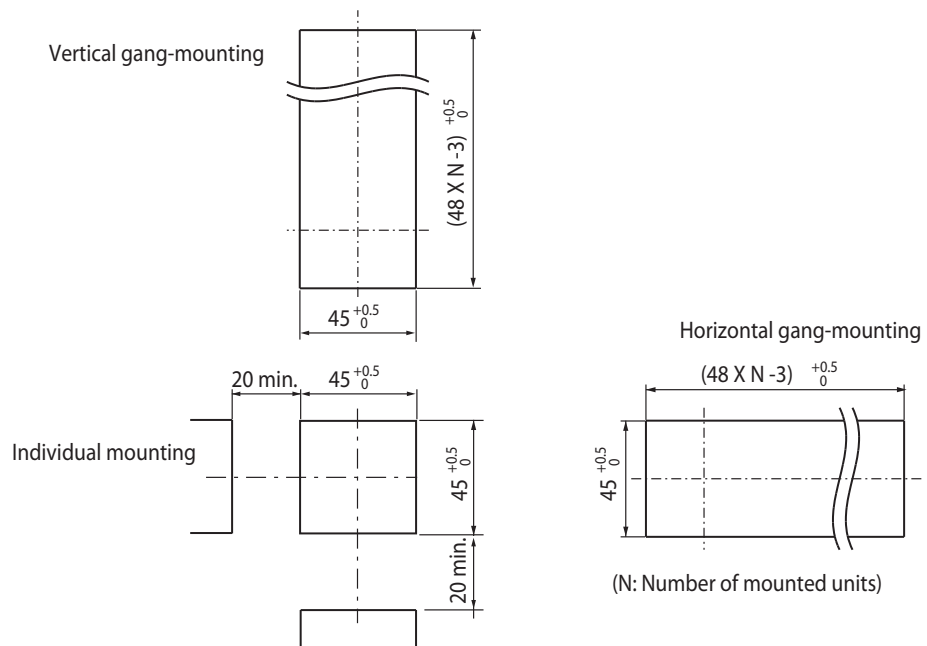

● Mounting on a panel

The mounting panel should be used with a thickness of 2 to 7 mm of steel.

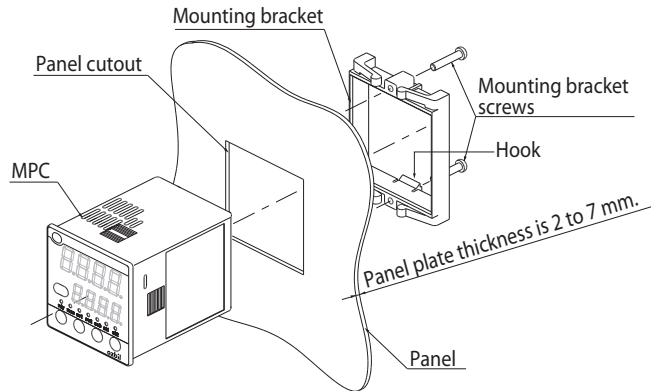

! Handling Precautions

- To fasten this controller onto the panel, tighten a mounting bracket screws, and turn one more half turn when there is no play between the bracket and panel. Excessively tightening the screws might deform the controller case.

● Piping connection

- When this controller is mounted on a panel, use piping which does not give a stress to the controller case during and after the piping work.
- Connect the piping so that the gas flows in the direction from IN to OUT as indicated on the body.
- After connecting piping, check for any gas leaks.

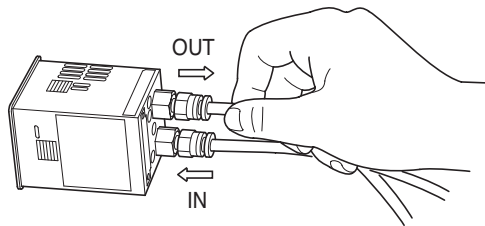

! Handling Precautions

- When metal piping is directly connected to the piping connection port, this controller cannot be mounted on a panel. Doing so will deform or damage the case.
- When leak check is performed using leak check liquid, ensure to avoid spillage or contact of liquid on to the case, electrical wires and connectors. Doing so might cause malfunction or faulty operation.

■ Wiring

CAUTION

- ❗ Be sure to turn the power supply source OFF before wiring connection. Doing so might cause faulty operation.
- ❗ The power supply circuit of this controller and the I/O circuit are not isolated each other. Therefore, ensure that the power supply of this controller is isolated from the power supply for external devices (insulate the power supply). If a common power supply is used for the controller and the external devices, it might cause malfunction or faulty operation.
- ❗ Be sure to check that the wiring is correct before you turn the power ON. Incorrect wiring might cause damage or malfunction.

● Connector specifications

- Part No.: MCVW1.5 / 9-STF-3.5 (Phoenix Contact Mfg.)
- Wire type: Either of single core wire or stranded wire applicable.
- Compatible cable: 0.08 to 1.5 mm² (AWG#28 to #16)
- Appropriate length of stripped wire: 7 mm

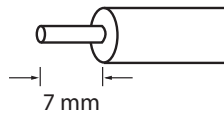

- Compatible screw driver: Tip size 2.5 x 0.4 mm (a flat-head driver)

● Connector signal names

Pin number	Signal name	Description	Remarks
1	POWER (24 V)	Power+ (24 Vdc)	
2	POWER GND	Power supply ground	
3	EV1	Event output 1	Open collector non-insulated output
4	EV2	Event output 2	
5	DI1	External switch input 1	Switching input (OPEN / GND)
6	DI2	External switch input 2	
7	(1) AI (2) DA	(1) Analog setting voltage input (2) RS-485 communications DA	(1) For the model with analog I/O function (0 to 5 V or 1 to 5 V) (2) For the model with RS-485 communication function
8	(1) AO (2) DB	(1) Analog flowrate voltage output (2) RS-485 communications DB	
9	SIGNAL GND	Signal ground	Input / output signal common Signal ground is connected with power supply ground inside this device.

● Wiring

• Power supply

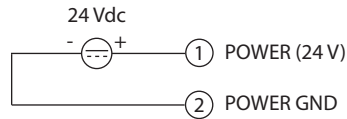

• Event output

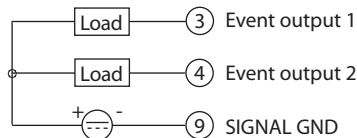

! Handling Precautions

- Be sure that the event output does not exceed the specified output rating of this controller. When driving a relay, use the relay with a built-in diode for coil surge absorption. Doing so might cause faulty operation.

• External switch input

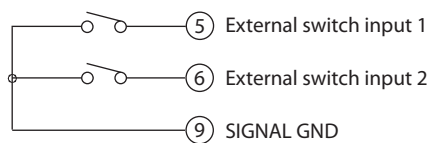

! Handling Precautions

- When using a relay for external switch input, always use a relay designed for micro-current use (with gold contacts). Failure to do so could cause faulty contact, resulting in malfunction.

• Analog input/output (only for the model with analog I/O function)

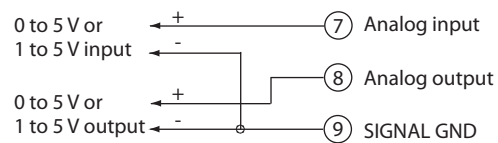

! Handling Precautions

- Do not apply a negative voltage or a voltage exceeding 5 V to the analog I/O terminals. Doing so might cause malfunction or equipment failure.

- RS-485 communication (only for the model with RS-485 communication function)

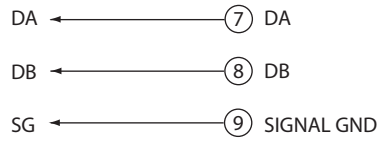

Note

- For details on how to connect the RS-485 communications, see MPC9500/0002/0005/0020 Panel Mount Mass Flow Controller "Communications Functions" CP-SP-1154E.

● **Wiring example**

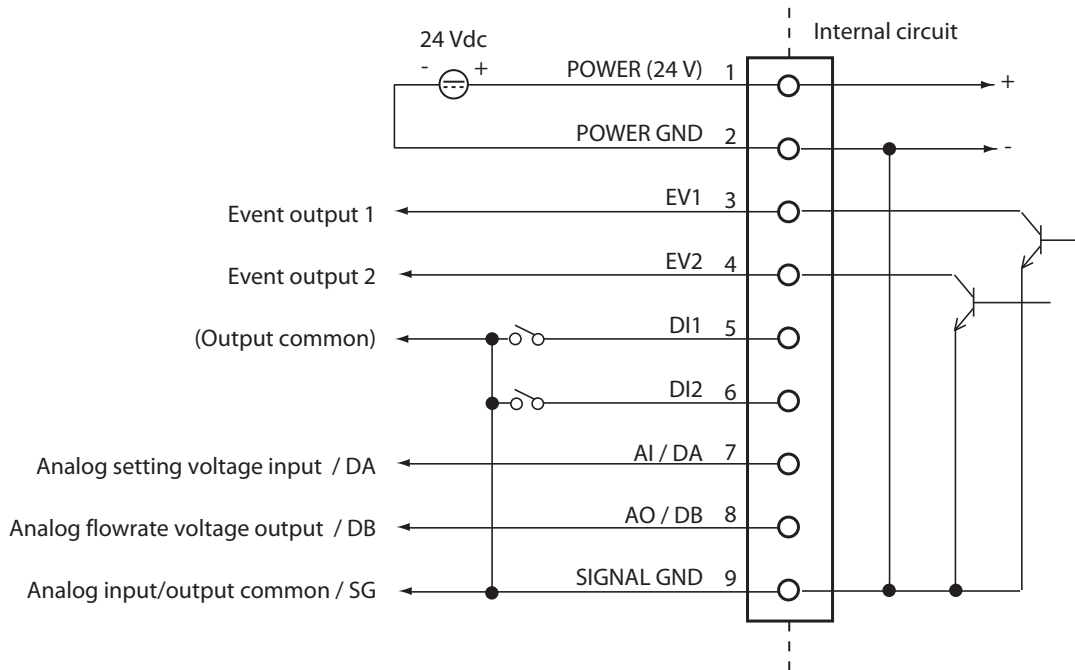

Chapter 4. BASIC OPERATION

4 - 1 Switching Displays

Each press of the [DISP] key switches the display as shown below. The display shown below is an example.

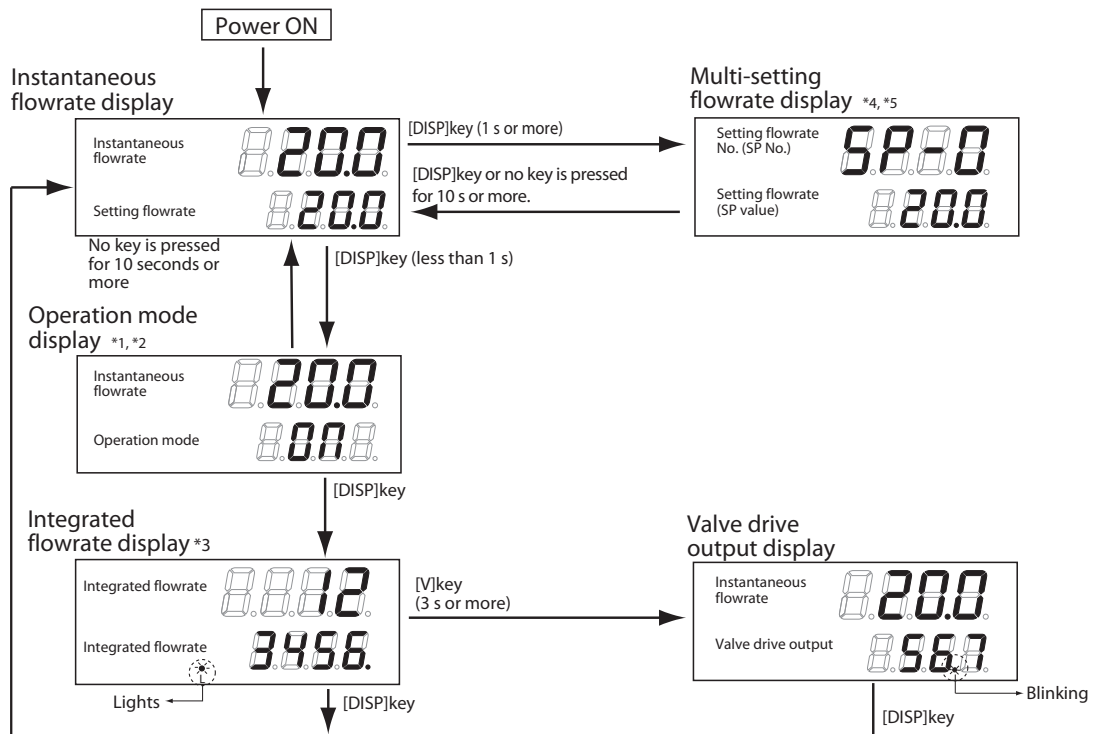

- *1 The operation mode display is not displayed when the "0: The operation mode selection by key operation is disabled" is selected at the operation mode selection ζ -02 in function setup.
- *2 If no key is pressed while the operation mode is displayed, the display will automatically return to the instantaneous flowrate display after approximately 10 seconds.
- *3 When the [ENT]key is pressed for 3 seconds or more while the integrated flowrate is displayed, the integrated flowrate value is reset.
- *4 The multi-setting flowrate is displayed only when the multi-setting (1 to 3) is selected at flowrate setup number selection ζ -04 in function setup. For details on function setup method, refer to;
 Chapter 5. ADVANCED OPERATION.
- *5 If no key is pressed while the multi-setting flowrate is displayed, the display will automatically return to the instantaneous flowrate display after approximately 10 seconds.

● Instantaneous flowrate display (+ setting flowrate display)

When the power is turned ON, the instantaneous flowrate value is indicated on the upper display and the setting flowrate value is indicated on the lower display. (The number of effective digits which are displayed differs according to the flowrate range.)

The operating mode is also indicated on the upper display when the operating mode is changed. For details, refer to;

4-3 Selecting the Operating Mode (page 4-6).

● Operating mode display (+ instantaneous flowrate display)

When the [DISP] key is pressed (for less than 1 second) while the instantaneous flowrate is displayed, the upper display maintains the instantaneous flowrate and the lower display indicates the operation mode. The table below shows the display contents to each operation mode.

For the operating mode selection method, refer to;

☞ 4-3 Selecting the Operation Mode (page 4-6).

If no key is pressed while the operation mode is displayed, the display will automatically return to the instantaneous flowrate display after approximately 10 seconds.

Operation mode	Lower display
Fully closed mode	<i>OFF</i>
Control mode	<i>ON</i>
Fully open mode	<i>FULL</i>

● Integrated flowrate display

When the [DISP] key is pressed while the operation mode is displayed, the "L" lamp lights and the integrated flowrate value is indicated on the upper display and lower display.

For instance, if the integrated flowrate is 1,234,567.8 L, the "~~1234~~" is indicated on the upper display and the "~~567.8~~" is indicated on the lower display.

Integrated flowrate reset operation: Keep the [ENT] key pressed for 3 seconds or more while the integrated flowrate is displayed.

● Valve drive output display (+ instantaneous flowrate display)

When the [V] key is pressed for 3 seconds or more while the integrated flowrate is displayed, the valve drive output value (indication range: 0.0 to 100.0 %) is indicated on the lower display. (The instantaneous flowrate is indicated on the upper display.)

In order to distinguish from other indication, the decimal point indication blinks while the valve drive output is displayed.

● Multi-setting flowrate display (only when the multi-setting is enabled)

When the [DISP] key is pressed for one second or more while the instantaneous flowrate display, the setting flowrate number (SP No.) currently being selected is indicated on the upper display and the setting flowrate value (SP value) is indicated on the lower display. If no key is pressed for 10 seconds or more while the multi-setting flowrate is displayed, the display will automatically return to the instantaneous flowrate display.

4 - 2 Setting the Flowrate

■ Procedure for changing flowrate in digital setting

● Single SP setting mode (number of SPs = 1 according to function setup ζ - 04)

Follow the procedure below to change the SP value (setting flowrate).

- (1) Press the [DISP] key.
 - >>The instantaneous flowrate value and SP value are displayed.
(Same as the display at power supply ON)
- (2) Press the [\wedge] key or [v] key.
 - >>The digit currently being changed blinks. You can move to the digit to be changed by pressing the [<] key.
- (3) When the target value is displayed, press the [ENT] key.
 - >>The SP value is fixed. At this point, the SP value is updated.



Note

• Direct setup function

The control can be executed using the SP value currently being changed (indicated by blinking display) when the "Direct setup function is enabled" is selected at direct setup function switching ζ - 24 in the function setup.
(The [ENT] key does not need to be pressed to fix the SP value. However, to switch the display by pressing the [DISP] key, press the [ENT] key to fix the SP value, and switch the display.)

This function is useful when changing the SP value little by little.
(The factory setting is set to "Direct setup function is enabled".)

For the function setup method, refer to;

Chapter 5. ADVANCED OPERATION.

● Multi-SP setting mode (number of SPs = 2 to 4 according to function setup ζ - 04)

Up to four SP values (setting flowrate values) can be switched by key operation and by external switch inputs.

Follow the procedure below to change the SP No. and SP value.

- (1) Press the [DISP] key.
 - >>The instantaneous flowrate value and SP value are displayed.
(Same as the display at power supply ON)
- (2) Keep the [DISP] key pressed for 1 second or more.
 - >>The SP No. currently being selected (setting flowrate No.: SP-0 to SP-3) is indicated on the upper display, and the SP value is indicated on the lower display.
- (3) Press the [\wedge] key or [v] key to change the SP No.
- (4) When the target value is displayed, press the [ENT] key.
- (5) Press the [\wedge] key or [v] key to change the SP value.
 - >>The digit being changed blinks. You can move to the digit to be changed by pressing the [<] key.
- (6) When the target value is displayed, press the [ENT] key.
 - >>The SP value is fixed. At this point, the SP value and SP No. are updated.

 **Note**

- Direct setup function

The control can be executed using the SP value currently being changed (indicated by blinking display) when the "Direct setup function is enabled" is selected at direct setup function switching $\zeta - 2$ in the function setup.

(The [ENT] key does not need to be pressed to fix the SP value. However, to switch the display by pressing the [DISP] key, press the [ENT] key to fix the SP value, and switch the display.)

This function is useful when changing the SP value frequently or little by little.

(The factory setting is set to "Direct setup function is enabled".)

For the function setup method, refer to;

 Chapter 5. ADVANCED OPERATION

- As shown in the following table, up to 4 SP values can be switched according to the ON/OFF state of the external switch inputs when the "3: Switching of SP No." is assigned at the external switch input function assignments $\zeta - 10$ and $\zeta - 11$ in the function setup.

(If the number of SPs is two, set either one of $\zeta - 10$ or $\zeta - 11$ to "3: Switching of SP No.".) However, in this case, the SP No. cannot be updated using the [Λ] key or [V] key. Only the SP value can be updated.

External switch input state		SP to be selected
Input 1 (DI1)	Input 2 (DI2)	
OFF	OFF	SP-0
ON	OFF	SP-1
OFF	ON	SP-2
ON	ON	SP-3

 **Handling Precautions**

- If the [DISP] key is pressed while the settings are being changed (when a digit is blinking), the SP No. and SP value will not be saved and will revert to the previous values.
- When "1: Analog setting" is selected at the flowrate setup method selection $\zeta - 03$ in the function setup, and the operation is carried out using the SP value according to the analog setting voltage, the operation to change the SP value and SP No. using the [Λ] key or [V] key cannot be accepted.
- If no key is pressed for 10 seconds or more after performing the operation while the multi-setting flowrate is displayed on the previous page, the display will automatically return to the instantaneous flowrate display.

■ Procedure for changing flowrate in analog setting (a model with analog input / output function)

To change the SP value (setting flowrate value) using an external setting voltage, "1: Analog setting" is selected at the flowrate setup method selection $\zeta-03$ in the function setup.

For the function setup method, refer to;

➔ Chapter 5. ADVANCED OPERATION.

The setting voltage range can be selected at the analog input voltage range selection $\zeta-05$ in the function setup.

The analog setting voltage value to the SP value can be calculated from the calculation formulas in the following table:

$\zeta-05$	Voltage range	Setting voltage formulas
0	0 to 5 V	Setting voltage [V] = Setting flowrate ÷ Full-scale flowrate X 5.00
1	1 to 5 V	Setting voltage [V] = Setting flowrate ÷ Full-scale flowrate X 4.00 + 1.00

Note

- When the "1: Function enabled" is selected at the analog optional scaling function $\zeta-28$ in the function setup, the full-scale flowrate at analog setting can be optionally changed.

In this case, the full-scale flowrate of analog flowrate output voltage (PV output voltage) is also changed as same as input voltage. The scaling flowrate is set in the parameter setup mode.

For the function setup and parameter setup method, refer to;

➔ Chapter 5. ADVANCED OPERATION.

Handling Precautions

- Do not apply a negative voltage or a large voltage exceeding 5 V to the analog setting voltage input terminal. Doing so might cause faulty operation or malfunction.

4 - 3 Selecting the Operating Mode

When the [DISP] key is pressed for less than 1 second while the instantaneous flowrate is displayed (same as the display at power supply ON), the instantaneous flowrate indication on the upper display is not changed, and the lower display shows the operating mode, enabling the selection of operation mode.

Follow the procedure below to select the operation mode:

- (1) Press the [DISP] key to display the operation mode.
- (2) Press the [^] key or [v] key.
 >>The display is changed as shown below.

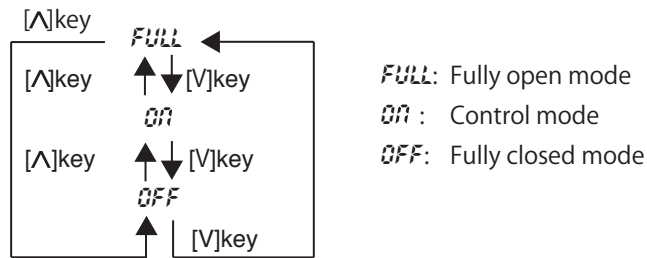

- (3) Select the target operating mode.
 >>Display blinks.
- (4) Press the [ENT] key to fix the operating mode.
 >>The operating mode is changed.

! Handling Precautions

- When “0: The operating mode selection by key operation is disabled” is selected at the operation mode selection $\xi - 02$ in the function setup, the operating mode is not displayed even if the [DISP] key is pressed.
- When the [DISP] key is pressed during the operation in step (3) (the operating mode indicated by blinking display), the operating mode selection is cancelled.

📖 Note

- When the operating mode selection 5, 6 or 8 is selected at the external switch input function assignment $\xi - 10$ and $\xi - 11$ in the function setup, the operating mode selection (valve fully closed / fully open) by the ON/OFF operation of external switch inputs can be performed.
 For the function setup method, refer to;
 📖 Chapter 5. ADVANCED OPERATION.
- When each operation mode is entered ever while the instantaneous flowrate is displayed, the operation mode is indicated on the upper display as shown below.
 The "OK" lamp blinks in fully open mode.

Table of operation mode displays while the instantaneous flowrate is displayed

Operating mode	Upper display	[OK] lamp	Remarks
Fully closed mode	OFF	Off	[OFF] is displayed at all times after flowrate zero is confirmed.
Control mode	ON	On or Off	[ON] is displayed for 1 second when the control mode is entered.
Fully open mode	FULL	Blinking	[FULL] is displayed for 1 second when the fully open mode is entered.

Chapter 5. ADVANCED OPERATION

When the following operation is performed while the integrated flowrate is displayed, the parameter setup mode and function setup mode are entered, and each setting value can be changed:

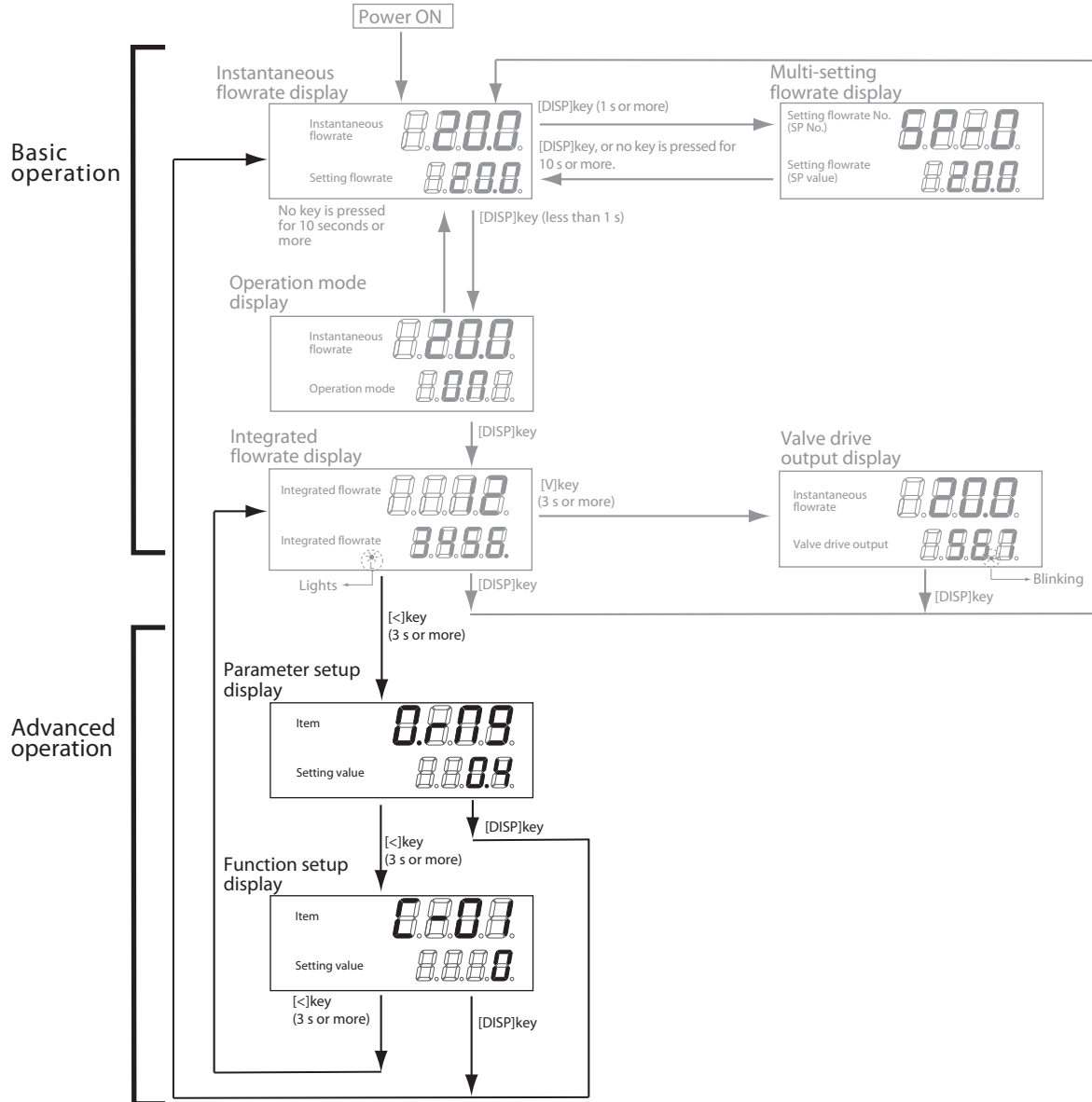

5 - 1 Function Setup

Follow the procedure below to set the functions such as event output type and external switch input assignments:

- (1) Press the [DISP] key to display the integrated flowrate value.
>>"L" lamp lights.
 - (2) Keep the [<] key pressed for 3 seconds or more.
>>"0.000" is indicated on the upper display. (Parameter setup mode)
 - (3) Keep the [<] key pressed for 3 seconds or more.
>>The item No. 1-01 is indicated on the upper display, and the function setup mode is entered.
 - (4) Press the [A] key or [V] key to select the target setup item No., and then press the [ENT] key.
>>The current setting value being indicated on the display blinks.
 - (5) Press the [A] key or [V] key to display the target setting value, and then press the [ENT] key.
>>The setting value is stored.
- If other items are required to set up, return to the step (4) and repeat the procedure. Otherwise, proceed to the step (6).
- (6) Press the [DISP] key.
>>The mode is returned to the instantaneous flowrate display.

Handling Precautions

- If any operation is not performed for one minute after entering the function setup mode, the display automatically returns to the regular display (instantaneous flowrate display).
- If the [DISP] key is pressed while the operation in step (5) is performed (indicated by blinking display), the setting value remains at the previous value without being updated.

■ Function setup item list

Display Item	Item Description	Setup Item and Description	Factory Setting	Remarks
└-01	Key lock	0: Unlocked 1: Settings other than flowrate setting are locked 2: All settings locked	0	The key lock can be canceled even while it is enabled. └o└ is indicated on the display during the key-locked setting.
└-02	Operating mode selection (selection by key operation)	0: Operating mode selection by key operation is disabled. 1: Operating mode selection by key operation is enabled.	1	The operating mode (fully closed/control/fully open) by key operation is selectable. ☞ 4-3 Selecting the Operating Mode (page 4-6)
└-03 *1 *2	Instantaneous flow-rate setup method (instantaneous SP setup method selection)	0: Digital setup (set by key operation or RS-485 communications) 1: Analog setup (set by external analog voltage input)	0	
└-04	Number of instantaneous flowrate setups selection (number of SPs selection)	0: Number of SPs = 1 (SP-0 only) 1: Number of SPs = 2 (SP-0, SP-1) 2: Number of SPs = 3 (SP-0 to SP-2) 3: Number of SPs = 4 (SP-0 to SP-3)	0	
└-05 *2	Input voltage range selection, at analog setting (Analog SP input range selection)	0: 0 to 5 V input 1: 1 to 5 V input	0	
└-06 *2	Flowrate analog output voltage range selection (PV analog output range selection)	0: 0 to 5 V output 1: 1 to 5 V output	0	
└-07	Event output 1 type assignment	0: Not used (OFF at all times) 1: ON when alarm occurred 2: Integration pulse output 3: On when PV is in flowrate OK judgment range 4: ON in control mode 5: ON in fully open mode 6: ON in control mode or fully open mode 7: ON in fully closed mode 8: Instantaneous PV upper limit event 9: Instantaneous PV lower limit event 1 10: Instantaneous PV lower limit event 2 11: Integrated flowrate event -1 to -11: Reverse output of 1 to 11 (At no events: ON At event occurred: OFF)	0	Flowrate OK judgment range, upper/lower limit event flowrate, integrated event flowrate and event output delay time are set in the parameter setup mode. ☞ 5-2 Parameter setup (page 5-7) for the details. Note, the delay time cannot be set to integration pulse output. 9: Events are outputted even in fully closed operation mode. 10: Events are not outputted in fully closed operation mode. -1 to -11: Always OFF during power supply OFF.
└-08	Event output 2 type assignment		0	

Display Item	Item Description	Setup Item and Description	Factory Setting	Remarks
ξ-10	External switch input 1 function assignment	0: Not used 1: Reset integration 2: Stop integration count operation 3: Switching of SP No.	0	3: To select an SP No. of 3 or more setting, assign "3" both the ξ-10 and ξ-11. 4: The ξ-03 (analog / digital) setting is reversed when the contact is ON. 7: "Slow start ON" must be selected in ξ-17. 5, 6, 8: When the valve fully closed input and the valve fully open input are put in at the same time by two contact, the both inputs are disabled.
ξ-11	External switch input 2 function assignment	4: Switching of flowrate setup method 5: Valve fully closed 6: Valve fully open 7: Switching of slow start operation 8: Switching of operating mode (Contact ON: control mode Contact OFF: fully closed mode)	0	
ξ-13	Valve automatic shut-off when the integration event occurred	0: Function disabled 1: Function enabled	0	When the integrated count value reaches the integrated event setting value, the valve is fully closed.
ξ-14	Resetting the integrated value at start of control	0: Function disabled 1: Function enabled	0	When control is resumed from the fully closed mode, the integrated value is automatically reset.
ξ-15	Flowrate alarm setup type	0: Not used 1: Only upper limit alarm used 2: Only lower limit alarm used 3: Upper / lower limit alarm used	3	Set the alarm flowrate in the parameter setup mode.  page 5-7.
ξ-16	Operation selection at alarm occurrence	0: Control continued (alarm ignored) 1: Move to fully closed 2: Move to fully open	0	Alarm output turns ON even if "0" is selected.
ξ-17	Slow start setup	0: Slow start disabled 1 to 8: Slow start enabled (equivalent to approx. 1 to 6 seconds settling time)	0	Slow start is enabled when the external contact input turns ON, in case of slow start operation switching is selected at ξ-10 and ξ-11.
ξ-18	Gas type selection	0: Conversion factor for each gas type set by the user 1: Air/Nitrogen 3: Argon 4: Carbon dioxide (CO ₂)	1	If the flowrate range changes due to a change in the gas type, the flowrate OK range and flowrate alarm range in the parameter setup must be changed. When "0" is selected, set the conversion factor in the parameter setup mode.
ξ-19	Flowrate display	0: 20 °C, 101.325 kPa (1 atm) 1: 0 °C, 101.325 kPa (1 atm) 2: 25 °C, 101.325 kPa (1 atm) 3: 35 °C, 101.325 kPa (1 atm)	0	

Display Item	Item Description	Setup Item and Description	Factory Setting	Remarks
℄-20	Inlet pressure adjustment	0: 0 to 0.1 MPa 1: 0.05 to 0.15 MPa 2: 0.15 to 0.25 MPa 3: 0.25 to 0.35 MPa 4: 0.35 to 0.45 MPa 5: 0.45 to 0.5 MPa	2	The accuracy drift caused by the influence of pressure can be compensated by adjusting the inlet pressure setting to the actual inlet pressure.
℄-21	Instantaneous flowrate direct setup function switching	0: Function disabled 1: Function enabled	0	Instantaneous flowrate can be controlled by instantaneous SP being change (blinking).
℄-23	PV filter	0: Without filter 1: Sampling 2 times moving-average 2: Sampling 4 times moving-average 3: Sampling 8 times moving-average	0	If the PV filter is used in a "2" or "3" setting, the operation differential pressure must be lower than the standard differential pressure. Do not change the setting under the control.
℄-28 *2	Analog optional scaling function	0: Function disabled 1: Function enabled	0	The flowrate at analog input / output 100 % (5 V) can be optionally set. The flowrate is set in parameter setup mode. ☞ page 5-7 for details.
℄-29	PV forced zero function	0: Function disabled 1: Function enabled	0	When the setting flowrate is zero, or when the valve fully closed mode is entered, the PV is forcibly made to zero after delay time. The shifting of PV by influence of pressure can be cancelled. The delay time is set in the parameter setup mode. ☞ page 5-7 for details.
℄-30 *3	Station address setting	0: Communications function disabled 1 to 127: Station address	0	
℄-31 *3	Transmission speed selection	0: 38400 bps 1: 19200 bps 2: 9600 bps 3: 4800 bps 4: 2400 bps	0	
℄-32 *3	Communications conditions selection	0: 8 data bits, even parity, 1 stop bit 1: 8 data bits, no parity, 2 stop bits	0	
℄-35 *4	SP limit function	0: SP limit function disabled 1: Upper limit only 2: Lower limit only 3: Both upper and lower limit	0	The upper and lower limit values of the flowrate setup range can be set to desired levels. The upper and lower limits are set in parameter setup mode. ☞ page 5-7 for details.

*1 When "4: Switching of flowrate setup method" is selected at the external switch input function assignment ℄-10 or ℄-11, the switching by external switch input takes precedence.

*2 These items can be set only on the models with analog input / output function.

*3 These items can be set only on the models with RS-485 communication function.

*4 This function is invalid for the controller shipped before Dec. 2006.

5 - 2 Parameter Setup

■ Setup method

Follow the procedure below to set the parameters such as flowrate deviation alarm upper and lower limit flowrate and event output delay time.

- (1) Press the [DISP] key to display the integrated flowrate.
>>"L" lamp lights.
 - (2) Keep the [<] key pressed for 3 seconds.
>>"0.000" is indicated on the upper display. (Parameter setup mode).
 - (3) Press the [∧] key or [v] key to select the target setup item, and press the [ENT] key.
>> The setting value currently being indicated on the lower display blinks.
 - (4) Press the [∧] key or [v] key to select the target setting value. You can move to the digit to be changed by pressing the [<] key.
 - (5) When the target setting value is displayed, press the [ENT] key to fix the setting value.
>>The setting value is stored.
- If other items are required to set up, return to the step (3) and repeat the procedure. Otherwise, proceed to the step (6).
- (6) Press the [DISP] key.
>>The mode is returned to the instantaneous flowrate display.

❗ Handling Precautions

- If you do nothing for one minute after entering the parameter setup mode, the display automatically returns to the regular (instantaneous PV) display.
- If you press the [DISP] key without pressing the [ENT] key after carrying out the operation in step (5), the setting remains at the previous value without being updated.

● Parameter setup item list

No.	Display	Description	Factory Setting	Setting Range	Referential function setup	Remarks
1	<i>Q.r.03</i> *1	Flowrate OK judgment range	(2 % FS) *11	(0.5 to 100 % FS) *11	<i>C-07</i> , <i>C-08</i>	Unit: L / min(standard)
2	<i>Q.HYS</i> *1	Flowrate OK judgment hysteresis	(1 % FS) *11	(0.5 to 100 % FS) *11		
3	<i>R.HI</i> *2, *3	Flowrate deviation upper limit alarm	(10 % FS) *11	(0.5 to 100 % FS) *11	<i>C-07</i> , <i>C-08</i> ,	
4	<i>R.H.HY</i> *2, *3	Flowrate deviation upper limit alarm hysteresis	(2 % FS) *11	(0.5 to 100 % FS) *11	<i>C-15</i> , <i>C-16</i>	
5	<i>R.Lo</i> *2, *3	Flowrate deviation lower limit alarm	(10 % FS) *11	(0.5 to 100 % FS) *11		
6	<i>R.L.HY</i> *2, *3	Flowrate deviation lower limit alarm hysteresis	(2 % FS) *11	(0.5 to 100 % FS) *11		
7	<i>R.dLY</i> *3	Flowrate deviation alarm judgment delay time	10.0 s	1.0 to 999.9 s		
8	<i>E.1.dL</i> *4	Event output 1 delay time	0.0 s	0.0 to 999.9 s	<i>C-07</i> , <i>C-08</i>	Even if the delay time is set, it is disabled during selection of integration pulse output.
9	<i>E.2.dL</i> *4	Event output 2 delay time	0.0 s	0.0 to 999.9 s		
10	<i>C.F.</i> *5	User setup conversion factor	1.000	0.100 to 9.999	<i>C-18</i>	
11	<i>E.1.SP</i> *6	Event output 1 upper / lower limit flowrate setup	(0 % FS) *11	(0 to 100 % FS) *11	<i>C-07</i> , <i>C-08</i>	Unit: L / min(standard)
12	<i>E.2.SP</i> *6	Event output 2 upper / lower limit flowrate setup	(0 % FS) *11	(0 to 100 % FS) *11		
13	<i>R.SCL</i> *7	Analog optional scaling	(100 % FS) *11	(10 to 100 % FS) *11	<i>C-28</i>	The flowrate of analog input / output 100 % (5 V) is set. Unit: L / min(standard)
14	<i>E.R.Lo</i> *8	Integrated event flowrate (lower 4 digits)	0	0 to 9999	<i>C-07</i> , <i>C-08</i> , <i>C-13</i>	
15	<i>E.R.HI</i> *8	Integrated event flowrate (upper 4 digits)	0	0 to 9999		
16	<i>P.O.dL</i> *9	PV forced zero function	3.0 s	0.0 to 999.9 s	<i>C-29</i>	
17	<i>S.P.L.H</i> *10	SP upper limit flowrate	(100 % FS) *11	(10 to 100 % FS) *11	<i>C-35</i>	Unit : L/min (standard) When the upper limit flowrate is set lower than the lower limit flowrate, the upper limit flowrate is prioritized than the lower.
18	<i>S.P.L.L</i> *10	SP lower limit flowrate	(0 % FS) *11	(10 to 100 % FS) *11		

*1 Operation during judgment of flowrate OK.

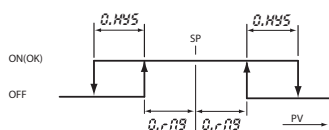

*2 Operation during judgment of flowrate deviation upper and lower limit alarms.

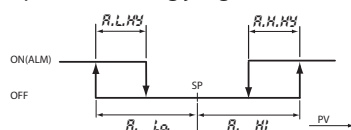

-
- *3 This item can be set only when other than "0: Not used" is selected at the flowrate alarm setup type $\zeta-15$ in the function setup.
 - *4 This item can be set only when other than "0: Not used" is selected at the event output type assignment $\zeta-07$ and $\zeta-08$ in the function setup.
 - *5 This item can be set only when "0: User setting" is selected at gas type selection $\zeta-18$ in the function setup.
 - *6 This item can be set only when "8: Instantaneous PV upper limit event, 9: Instantaneous PV lower limit event1 and 10: Instantaneous PV lower limit event 2" is selected for the $\zeta-07$ and $\zeta-08$ event output type assignment in the function setup.
 - *7 This item can be set only when "1: Function enabled" is selected for the $\zeta-28$ analog optional scaling function in the function setup.
 - *8 This item can be set only when "11: Integrated flowrate event" is selected at the event output type assignment $\zeta-07$ and $\zeta-08$ in the function setup, or when "1: Function enabled" is selected at the valve automatic shut-off function $\zeta-13$.
 - *9 This item can be set only when "1: Function enabled" is selected at the PV forced zero function $\zeta-29$ in the function setup.
 - *10 This item can be set only if suitable limit type is selected for the $\zeta-35$ SP limit function in the function setup.
 - *11 The factory setting and setting range becomes the flowrate obtained by multiplying the full scale flowrate by the percentage in parentheses. (The factory setting and setting range vary according to the gas type.)

Chapter 6. TROUBLESHOOTING

■ Alarm code display

When a flowrate deviation alarm occurs or when an alarm occurs during controller self-diagnostics, the operating mode currently selected at "Operation selection at alarm occurrence" $\zeta - 15$ in the function setup is forcibly switched to. (Except $R171$) The upper display alternately indicates the alarm codes shown in the table below and the regular display.

Alarm code	Error	Cause	Countermeasure
$R101$	Flowrate deviation lower limit alarm	Insufficient alarm judgment delay time, insufficient power voltage, insufficient inlet pressure, excessive operating temperature, etc.	Request for repair service if there is no problem on the items listed on the left.
$R102$	Flowrate deviation upper limit alarm	Insufficient alarm judgment delay time, valve trouble, sensor trouble, etc.	Request for repair service if there is no problem with the delay time.
$R171$	Valve overheat prevention limit is operated	During the control or fully-open mode, the gas is forcibly shut-off by external device.	When the gas is continuously shut off by external device, set the set flowrate to zero or valve fully-closed mode.
$R181$	Sensor error	Sensor trouble, foreign object attached to sensor, or entering of hydrogen or helium gas.	If sensor is not restored after turning the power OFF, then request for repair service.
$R191$	I/O correction data error	Data corrupted due to electrical noise.	Request for repair service.
$R192$	Sensor calibration data error	Data corrupted due to electrical noise.	Request for repair service.
$R193$	User setup data error	Power shutoff during writing of data.	Set data again.

❗ Handling Precautions

- The alarm code is displayed only during the instantaneous flowrate, operating mode and integrated flowrate are displayed.
- The timing for activation of the valve overheating limit ($R171$) varies depending on the model. As long as the conditions causing $R171$ remain, the current to the valve will be forcibly limited regardless of the setting for $\zeta - 15$ in the function setup. If this situation continues, the final result will be that the valve is fully closed.
- If $R181$ (sensor error) occurs, the flowrate value will become indefinite. Therefore, the control flowrate becomes indefinite even if "0: Control continued (alarm ignored)" is selected at $\zeta - 15$ in the function setup.
- When "1: Move to fully closed" or "2: Move to fully open" is selected at $\zeta - 15$ in the function setup, the alarm display and the operating mode at alarm occurrence can be maintained even after the cause of alarm is removed. When canceling the alarm, make the alarm reset operation.

● Canceling the alarm

Keep the [ENT] key pressed while the instantaneous flowrate is displayed. The alarm can be cancelled after 3 seconds.

■ Other troubles

Error	Cause	Countermeasure
<p>Flowrate display does not become zero even in spite of an actual zero flowrate. (Display does not become OFF even if the valve is fully closed.)</p>	<ul style="list-style-type: none"> • Zero point shift due to the influence of pressure. • Gas type setup is incorrect. • Condensation on sensor. • Foreign object attached to sensor. 	<ul style="list-style-type: none"> • Adjust the inlet pressure setting (function setup $\zeta - \text{2}^{\text{0}}$) with the actual inlet pressure used, or use the PV forced zero function (function setup $\zeta - \text{2}^{\text{4}}$). • Adjust the gas type setting (function setup $\zeta - \text{1}^{\text{8}}$) with the actual gas used. • Insert a mist trap upstream. • Request for repair service.
<p>Flowrate does not stabilize.</p>	<ul style="list-style-type: none"> • Operation differential pressure range is exceeded. • Large inlet pressure fluctuations. • Regulator interference. • Large pressure loss between regulator and this device. (Large fluctuation in inlet pressure according to flowrate.) 	<ul style="list-style-type: none"> • Reduce the inlet pressure. • Install a regulator upstream. • Change the regulator pressure setting or apply the PV filter. (function setup $\zeta - \text{2}^{\text{3}}$) • Change the pipe bigger diameter.
<p>Poor accuracy</p>	<ul style="list-style-type: none"> • Temperature reference does not match the reference flowmeter. • Regulator is vibrating slightly. • Foreign object attached to sensor. 	<ul style="list-style-type: none"> • Adjust the temperature reference. (It can be changed in the function setup $\zeta - \text{1}^{\text{9}}$) • Change the regulator pressure setting. • Request for repair service.

Chapter 7. SPECIFICATIONS

■ Specifications

Specifications are given on the next page.

Chapter 7. SPECIFICATIONS

Item		Model No.	MPC9500	MPC0002	
Valve type		Proportional solenoid valve			
Valve operation		Normally closed when de-energized (N.C.)			
Standard full-scale flowrate (nitrogen conversionvalue) *1		0.500 L/min(standard)	2.00 L/min(standard)		
Standard compatible gas types		Air/Nitrogen, argon, carbon dioxide (CO ₂) Note; The gas must be a dry gas not containing corrosive components (chlorine, sulfur, acid). The gas must also be a clean gas not containing dust or oil mist.			
Control	Control range *1	4 to 100 % FS *1			
	Response	Within 1.0 s (typ) to set point ± 2 % FS			
	Accuracy	±2 % FS max. (at standard temperature and differential pressure)			
	Repeatability	±1 % FS max.			
	Temperature influence	A maximum of 0.1 % FS per °C			
	Pressure influence (per 0.1 MPa Q: flowrate)	Q ≥ 40 % FS	0.7 % FS max.	0.4 % FS max.	
10 % FS ≤ Q < 40 % FS		1.2 % FS max.	0.7 % FS max.		
Q < 10 % FS		2 % FS max.	1.2 % FS max.		
Pressure	Standard differential pressure	0.2 MPa [290 PSI] (Inlet pressure: 0.2 MPa [290 PSI] (gauge), outlet pressure: 0.0 MPa [0 PSI] (gauge))			
	Required differential pressure *2	0.05 MPa [72.5 PSI]			
	Operating differential pressure range *3	0.3 MPa [435 PSI] max.			
	Pressure resistance	0.5 MPa [725 PSI] (gauge)			
Temperature	Standard temperature	25 °C [77 °F]			
	Allowable operating temperature range	-10 to +50 °C [14 to 122 °F] (0 to 50 °C [32 to 122 °F] when RS-485 communication)			
	Allowable storage temperature range	-10 to +60 °C [14 to 140 °F]			
Humidity	Allowable operating humidity range	10 to 90 % RH(no condensation allowed)			
Flowrate setup	Setup method	(1)Key operation (2)External setup voltage input (only for the model with analog I/O function) (3)Loader communication *5 (4)RS-485 communications (only for the model RS-485 communications function) *6			
	Setup resolution	*1			
	Setup input voltage range	0 to 5 Vdc/1 to 5 Vdc (selectable by function setup), Input impedance : 1 MΩ ±10 % (only for the model with analog I/O function)			
Flowrate display	Display method	7-segment LED 8 digits (For the instantaneous flowrate display: 4 digits and for the setting flowrate display:4 digits)			
	Indication resolution	*1			
	Indication accuracy	±2 % FS ±1 digit (at standard temperature and differential pressure)			
Integration function	Indication range	0.00 to 999,999.99 L	0.0 to 9,999,999.9 L		
	Indication resolution	0.01 L	0.1 L		
	Data backup timing	(1)At each 5 L count	(1)At each 20 L count		
		(2)At each after 1 hour from the previous backup			
Flowrate output *4	Output scale	0 to full-scale flowrate (scaling available)			
	Standard output voltage range	0 to 5 Vdc/1 to 5 Vdc (selectable by function setup)			

MPC0005	MPC0020
Proportional solenoid valve	
Normally closed when de-energized (N.C.)	
5.00 L/min (standard)	20.0 L/min (standard)
Air/Nitrogen, argon, carbon dioxide (CO ₂) Note; The gas must be a dry gas not containing corrosive components (chlorine, sulfur, acid). The gas must also be a clean gas not containing dust or oil mist.	
2 to 100 % FS *1	
Within 1.0 s (typ) to set point ±2 % FS	
±2 % FS max. (at standard temperature and differential pressure)	
±1 % FS max.	
A maximum of 0.1 % FS per °C	
0.2 % FS max.	0.2 % FS max.
0.3 % FS max.	0.2 % FS max.
0.5 % FS max.	0.2 % FS max.
0.2 MPa [290 PSI] (Inlet pressure: 0.2 MPa [290 PSI] (gauge), outlet pressure: 0.0 MPa [0PSI] (gauge))	
0.1 MPa [145 PSI]	0.15 MPa [217.5 PSI]
0.3 MPa [435 PSI] max.	0.05 to 0.3 MPa [72.5 to 435 PSI]
0.5 MPa [725PSI] (gauge)	
25 °C [77 °F]	
-10 to +50 °C [14 to 122 °F] (0 to 50 °C [32 to 122 °F] when RS-485 communication)	
-10 to +60 °C [14 to 140 °F]	
10 to 90 %RH (no condensation allowed)	
(1)Key operation (2)External setup voltage input (only for the model with analog I/O function) (3)Loader communication *5 (4)RS-485 communications (only for the model RS-485 communications function) *6	
*1	
0 to 5 Vdc/1 to 5 Vdc (selectable by function setup), Input impedance : 1 MΩ ±10 % (only for the model with analog I/O function)	
7-segment LED 8 digits (For the instantaneous flowrate display: 4 digits and for the setting flowrate display: 4 digits)	
*1	
±2 % FS ±1 digit (at standard temperature and differential pressure)	
0.0 to 9,999,999.9 L	0 to 99,999,999 L
0.1 L	1 L
(1)At each 50 L count	(1)At each 200 L count
(2)At each after 1 hour from the previous backup	
0 to full-scale flowrate (scaling available)	
0 to 5 Vdc/1 to 5 Vdc (selectable by function setup)	

Item		Model No.	MPC9500	MPC0002
Flowrate output	Max. output voltage	7 Vdc max. (maximum output when flowrate exceeds range)		
	Accuracy	±0.5 % FS (The input impedance of the connected device must be at least 100 kΩ.) Total output accuracy: Indication accuracy ±0.5 % FS		
Event output	Number of outputs	2 points		
	Output rating	30 Vdc 15 mA max. (open collector non-insulated output)		
	Integrated pulse output width	100 ms ±10 % (when the integrated pulse output is selected.)		
	Integrated pulse rate	0.01 L / 1 pulse	0.1 L / 1 pulse	
External switch input	Number of inputs	2 points		
	Circuit type	Non-voltage contact or open collector		
	Contact OFF terminal voltage	2.0± 0.5 V		
	Contact ON terminal current	Approx. 0.5 mA (contact current)		
	Allowable ON contact resistance	Max. 250 Ω		
	Allowable OFF contact resistance	Min. 100 kΩ		
	Allowable ON residual voltage	Max. 1.0 V (with open collector)		
	Allowable OFF leakage current	Max. 50 μA (with open collector)		
Communi- cation	System	(1)Loader communication *5 (2)RS-485 communications(3-wire) *6		
	Transmission speed	2400, 4800, 9600, 19200, 38400 bps (Only 19200 bps for loader communication)		
Power supply	Rating	24 Vdc, current consumption 300 mA max.		
	Allowable voltage range	22.8 to 25.2 Vdc (ripple 5 % max.)		
Material of gas-contacting parts		Brass(Ni plated), stainless steel, Teflon, Viton		
Connection method		Rc1/8		
Mounting direction		Display surface must be placed vertically (inlet port: lower side, outlet port: upper side)		
Mass		Approx. 300 g		
Accessories		Mounting bracket (81446917-001), wiring connector		
Applicable standard		EN61326-1: 2006, EN61326-2-3: 2006		

*1 L/min(standard) indicates the volume flowrate per minute (L/min) converted to 20 °C and 101.325 kPa (1 atm). The reference temperature can also be changed to 0 °C, 25 °C and 35 °C. The controllable flowrate range varies according to the gas type. Refer to the following table:

	MPC9500		MPC0002	
	Control flowrate range L / min(standard)	Setting/indication resolution L / min(standard)	Control flowrate range L / min(standard)	Setting/indication resolution L / min(standard)
Air / Nitrogen	0.020 to 0.500	0.002	0.08 to 2.00	0.01
Argon	0.020 to 0.500	0.002	0.08 to 2.00	0.01
Carbon dioxide (CO ₂)	0.012 to 0.300	0.001	0.040 to 1.200	0.005

	MPC0005		MPC0020	
	Control flowrate range L / min(standard)	Setting/indication resolution L / min(standard)	Control flowrate range L / min(standard)	Setting/indication resolution L / min(standard)
Air / Nitrogen	0.10 to 5.00	0.02	0.4 to 20.0	0.1
Argon	0.10 to 5.00	0.02	0.4 to 20.0	0.1
Carbon dioxide (CO ₂)	0.06 to 3.00	0.01	0.3 to 16.0	0.1

MPC0005	MPC0020
7 Vdc max. (maximum output when flowrate exceeds range)	
±0.5 % FS (The input impedance of the connected device must be at least 100 kΩ.) Total output accuracy: Indication accuracy ±0.5 % FS	
2 points	
30 Vdc 15 mA max. (open collector non-insulated output)	
100 ms ±10 % (when the integrated pulse output is selected.)	
0.1 L / 1 pulse	1 L / 1 pulse
2 points	
Non-voltage contact or open collector	
2.0 ±0.5 V	
Approx. 0.5 mA (contact current)	
Max. 250 Ω	
Min. 100 kΩ	
Max. 1.0 V (with open collector)	
Max. 50 μA (with open collector)	
(1)Loader communication *5 (2)RS-485 communications(3-wire) *6	
2400, 4800, 9600, 19200, 38400 bps (only 19200 bps for loader communication)	
24 Vdc, current consumption 300 mA max.	
22.8 to 25.2 Vdc (ripple 5 % max.)	
Brass(Ni plated), stainless steel, Teflon, Viton	
Rc1/8	
Display surface must be placed vertically (inlet port: lower side, outlet port: upper side)	
Approx. 300 g	
Mounting bracket (81446917-001), wiring connector	
EN61326-1: 2006, EN61326-2-3: 2006	

*2 Differential pressure required for obtaining full-scale flowrate.

*3 Operation is possible even under the required differential pressure. However, the controllable flowrate range will become small. For details, refer to;

 ■ Relationship between flowrate when valve is fully open and differential pressure (next page).

*4 Applicable only to the model with analog input/output function.

*5 The MLP200A100 Loader Package (sold separately) for the MPC is required.

*6 Applicable only to the model with RS-485 communications function.

■ Relationship between flowrate and differential pressure with valve fully opened (in air)

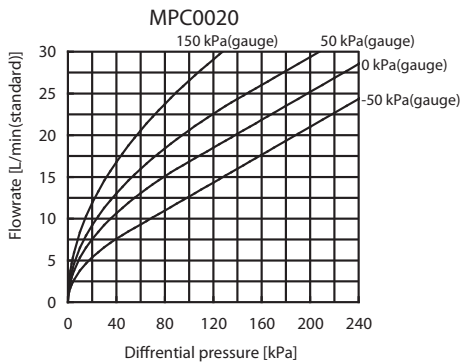
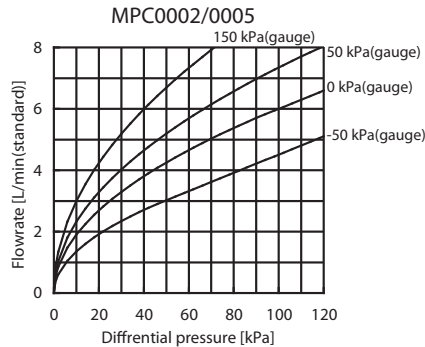
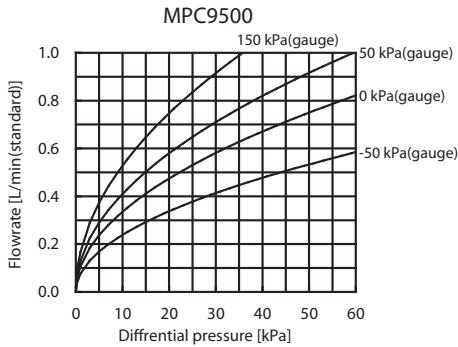

Four parameter show outlet pressure.

- If the outlet pressure is different from the values graphed on the above, calculate the flowrate using the appropriate formula below.

(1) When $P2 / P1 > 0.53$,
 $Q = C1 \sqrt{(P1 - P2)} \times P2$

(2) When $P2 / P1 \leq 0.53$,
 $Q = C2 \times P1$

P1: Inlet absolute pressure [kPa (abs)]

P2: Outlet absolute pressure [kPa (abs)]

(Absolute pressure = gauge pressure + atmospheric pressure)

Q: Flowrate [L/min (standard)]

C1 and C2: Constant values by model

• MPC 9500 : C1=0.01054, C2=0.00526

• MPC 0002 : C1=0.05971, C2=0.02981

• MPC 0005 : C1=0.05971, C2=0.02981

• MPC 0020 : C1=0.16740, C2=0.08357

Example : When using the MPC0020 with inlet pressure = 120 kPa (gauge) and outlet pressure = 0 kPa (gauge),

$P1 = 221.3$ kPa (abs), $P2 = 181.3$ kPa (abs)

$P2 / P1 = 0.819$

$$Q = 0.1674 \times \sqrt{(221.3 - 181.3)} \times 181.3 = 14.3 \text{ [L/min (Standard)]}$$

- When used with the gases other than air, convert the flowrate using the following formula :

$$\text{Flowrate} = \text{Flowrate in air} \div \sqrt{\text{specific gravity of gas to be controlled}}$$

Example : When using the MPC0020 with CO₂, inlet pressure = 100 kPa (gauge) and outlet pressure = 0 kPa (gauge)

$$16.8 \text{ L/min (standard)} \div \sqrt{1.53} = 13.6 \text{ L/min (standard)}$$

Specific gravity standard compatible gas (air is taken as 1.0)

Argon = 1.38

Carbon dioxide (CO₂) = 1.53

Revision History of CP-SP-1153E

Printed	Edn.	Revised pages	Description
Feb. 2004	1		
Mar. 2008	2		Overall revision. 2nd ed = 2nd Jp ed.
Apr. 2012	3		Company name changed.
Apr. 2013	4	ii i, 1-1, 3-8 ii, 1-4, 3-1, 7-4, 7-6 iv 1-4, 7-4 2-1, 3-4 3-1 4-4 5-4 6-1 7-2, 7-2, 7-3, 7-4, 7-5 7-6	The title of this manual was changed. A CAUTION was changed. MPC Series → MPC "Dioxide" was changed to "Dioxide (CO ₂)." Section, "The Role of This Manual" was changed. "1 atmospheric pressure" was changed to "1 atm." "MPC" was deleted from the figure. A WARNING was changed. A handling precaution was changed. The table was changed. The table was changed. A handling precaution was changed. Specifications were changed. "101.3 kPa" was changed to "atmospheric pressure."

Terms and Conditions

We would like to express our appreciation for your purchase and use of Azbil Corporation's products. You are required to acknowledge and agree upon the following terms and conditions for your purchase of Azbil Corporation's products (field instruments, control valves, and control products), unless otherwise stated in any separate document, including, without limitation, estimation sheets, written agreements, catalogs, specifications and instruction manuals.

1. Warranty period and warranty scope

1.1 Warranty period

Azbil Corporation's products shall be warranted for one (1) year from the date of your purchase of the said products or the delivery of the said products to a place designated by you.

1.2 Warranty scope

In the event that Azbil Corporation's products has any failure attributable to azbil during the aforementioned warranty period, azbil shall, without charge, deliver a replacement for the said product to the place where you purchased, or repair the said product and deliver it to the aforementioned place.

Notwithstanding the foregoing, any failure falling under one of the following shall not be covered under this warranty:

- (1) Failure caused by your improper use of Azbil Corporation's products (noncompliance with conditions, environment of use, precautions, etc. set forth in catalogs, specifications, instruction manuals, etc.);
- (2) Failure caused for other reasons than Azbil Corporation's products;
- (3) Failure caused by any modification or repair made by any person other than azbil or azbil's subcontractors;
- (4) Failure caused by your use of Azbil Corporation's products in a manner not conforming to the intended usage of that product;
- (5) Failure that the state of the art at the time of Azbil Corporation's shipment did not allow us to predict; or
- (6) Failure that arose from any reason not attributable to Azbil Corporation, including, without limitation, acts of God, disasters, and actions taken by a third party.

Please note that the term "warranty" as used herein refers to equipment-only-warranty, and Azbil Corporation shall not be liable for any damages, including direct, indirect, special, incidental or consequential damages in connection with or arising out of Azbil Corporation's products.

2. Ascertainment of suitability

You are required to ascertain the suitability of Azbil Corporation's products in case of your use of the same with your machinery, equipment, etc. (hereinafter referred to as "Equipment") on your own responsibility, taking the following matters into consideration:

- (1) Regulations and standards or laws that your Equipment is to comply with.
- (2) Examples of application described in any documents provided by Azbil Corporation are for your reference purpose only, and you are required to check the functions and safety of your Equipment prior to your use.
- (3) Measures to be taken to secure the required level of the reliability and safety of your Equipment in your use. Although Azbil Corporation is constantly making efforts to improve the quality and reliability of Azbil Corporation's products, there exists a possibility that parts and machinery may break down.

You are required to provide your Equipment with fool-proof design, fail-safe design, anti-flame propagation design, safety design, or the like so that the said Equipment may satisfy the level of the reliability and safety required in your use, whereby preventing any occurrence of physical injuries, fires, significant damage, and so forth.

3. Precautions and restrictions on application

Azbil Corporation's products other than those explicitly specified as applicable (e.g. azbil limit switch for Nuclear Energy) shall not be used in a nuclear energy controlled area (radiation controlled area).

Any Azbil Corporation's products shall not be used for/with medical equipment.

In addition,

you are required to conduct a consultation with our sales representative and understand detail specifications, cautions for operation, and so forth by reference to catalogs, specifications, instruction manual, etc. in case that you intend to use Azbil Corporation's products for any purposes specified in (1) through (6) below.

Moreover, you are required to provide your Equipment with fool-proof design, fail-safe design, anti-flame propagation design and other designs of protection/safety circuit on your own responsibility to ensure the reliability and safety, whereby preventing problems caused by failure or nonconformity.

- (1) For use under such conditions or in such environments as not stated in technical documents, including catalogs, specification, and instruction manuals
- (2) For use of specific purposes, such as:
 - * Nuclear energy/radiation related facilities
[For use outside nuclear energy controlled areas] [For use of Azbil Corporation's limit switch for Nuclear Energy]
 - * Machinery or equipment for space/sea bottom
 - * Transportation equipment
[Railway, aircraft, vessels, vehicle equipment, etc.]
 - * Antidisaster/crime-prevention equipment
 - * Burning appliances
 - * Electrothermal equipment
 - * Amusement facilities
- (3) Supply systems such as electricity/gas/water supply systems, large-scale communication systems, and traffic/air traffic control systems requiring high reliability
- (4) Facilities that are to comply with regulations of governmental/public agencies or specific industries
- (5) Machinery or equipment that may affect human lives, human bodies or properties
- (6) Other machinery or equipment equivalent to those set forth in items (1) to (5) above which require high reliability and safety

4. Precautions against long-term use

Use of Azbil Corporation's products, including switches, which contain electronic components, over a prolonged period may degrade insulation or increase contact-resistance and may result in heat generation or any other similar problem causing such product or switch to develop safety hazards such as smoking, ignition, and electrification. Although acceleration of the above situation varies depending on the conditions or environment of use of the products, you are required not to use any Azbil Corporation's products for a period exceeding ten (10) years unless otherwise stated in specifications or instruction manuals.

5. Recommendation for renewal

Mechanical components, such as relays and switches, used for Azbil Corporation's products will reach the end of their life due to wear by repetitious open/close operations. In addition, electronic components such as electrolytic capacitors will reach the end of their life due to aged deterioration based on the conditions or environment in which such electronic components are used. Although acceleration of the above situation varies depending on the conditions or environment of use, the number of open/close operations of relays, etc. as prescribed in specifications or instruction manuals, or depending on the design margin of your machine or equipment, you are required to renew any Azbil Corporation's products every 5 to 10 years unless otherwise specified in specifications or instruction manuals. Field instruments (sensors such as pressure/flow/level sensors, regulating valves, etc.) will reach the end of their life due to aged deterioration of parts. For those parts that will reach the end of their life due to aged deterioration, recommended replacement cycles are prescribed. You are required to replace parts based on such recommended replacement cycles.

6. Other precautions

Prior to your use of Azbil Corporation's products, you are required to understand and comply with specifications (e.g., conditions and environment of use), precautions, warnings/cautions/notices as set forth in the technical documents prepared for individual Azbil Corporation's products, such as catalogs, specifications, and instruction manuals to ensure the quality, reliability, and safety of those products.

7. Changes to specifications

Please note that the descriptions contained in any documents provided by Azbil Corporation are subject to change without notice for improvement or for any other reason. For inquires or information on specifications as you may need to check, please contact our branch offices or sales offices, or your local sales agents.

8. Discontinuance of the supply of products/parts

Please note that the production of any Azbil Corporation's products may be discontinued without notice. For repairable products, we will, in principle, undertake repairs for five (5) years after the discontinuance of those products. In some cases, however, we cannot undertake such repairs for reasons, such as the absence of repair parts. For field instruments, we may not be able to undertake parts replacement for similar reasons.

azbil

Azbil Corporation
Advanced Automation Company

1-12-2 Kawana, Fujisawa
Kanagawa 251-8522 Japan

URL: <http://www.azbil.com>

Specifications are subject to change without notice. (09)

1st edition: Feb 2004 (W)
4th edition: Apr. 2013 (V)