

SDC35/36

Single Loop Controller

User's Manual

for

Installation & Configuration



Thank you for purchasing an Azbil Corporation product.

This manual contains information for ensuring the correct use of this product. It also provides necessary information for installation, maintenance, and troubleshooting.

This manual should be read by those who design and maintain equipment that uses this product. Be sure to keep this manual nearby for handy reference.

Azbil Corporation

Getting Up to Speed with the SDC35/36

The quick reference guide on pages D-1 to D-8 summarizes key operations, parameters, and settings, and gives concrete operation examples using illustrations. Try looking at these pages first, and then read the main text for details.

A separate color version of the quick guide printed on dirt-resistant paper is available for convenient use on the work site (document No. CP-SP-1203E). Contact the azbil Group or a distributor for details.

NOTICE

Be sure that the user receives this manual before the product is used.

Copying or duplicating this user's manual in part or in whole is forbidden. The information and specifications in this manual are subject to change without notice.

Considerable effort has been made to ensure that this manual is free from inaccuracies and omissions. If you should find an error or omission, please contact the azbil Group.

In no event is Azbil Corporation liable to anyone for any indirect, special or consequential damages as a result of using this product.

© 2004-2016 Azbil Corporation All Rights Reserved.

Modbus™ is a trademark and the property of Schneider Electric SE, its subsidiaries and affiliated companies.

SAFETY REQUIREMENTS



To reduce risk of electric shock which could cause personal injury, follow all safety notices in this documentation.



This symbol warns the user of a potential shock hazard where hazardous live voltages may be accessible.

- If the equipment is used in a manner not specified by the manufacturer, the protection provided by the equipment must be impaired.
- Do not replace any component (or part) not explicitly specified as replaceable by your supplier.
- All wiring must be in accordance with local norms and carried out by authorized and experienced personnel.
- A switch in the main supply is required near the equipment.
- Main power supply wiring requires a (T) 0.5A, 250V fuse(s) (IEC 127).

EQUIPMENT RATINGS

Supply voltages:	100 to 240Vac (operating power supply voltage 85 to 264Vac)
Frequency:	50/60Hz
Power consumption:	12VA maximum

EQUIPMENT CONDITIONS

Do not operate the instrument in the presence of flammable liquids or vapors.

Operation of any electrical instrument in such an environment constitutes a safety hazard.

Temperature:	0 to 50°C
Humidity:	10 to 90%RH (non-condensing)
Vibration:	2m/s ² (10 to 60Hz)
Over-voltage category:	Category II (IEC60364-4-443, EN60664-1)
Pollution degree:	2
Installation location:	Indoors
Altitude:	2000m or less

EQUIPMENT INSTALLATION

The controller must be mounted into a panel to limit operator access to the rear terminal.

Specifications of common mode voltage: The common mode voltages of all I/O except for main supply and relay outputs are less than 30Vrms, 42.4V peak and 60Vdc.

STANDARDS COMPLIANCE

EN61010-1,

EN61326-1 (For use in industrial locations)

During EMC testing, the reading or output may fluctuate by $\pm 10\%$ FS.

SAFETY PRECAUTIONS

■ About Icons

The safety precautions described in this manual are indicated by various icons. Please be sure you read and understand the icons and their meanings described below before reading the rest of the manual.

Safety precautions are intended to ensure the safe and correct use of this product, to prevent injury to the operator and others, and to prevent damage to property. Be sure to observe these safety precautions.



WARNING

Warnings are indicated when mishandling this product might result in death or serious injury.



CAUTION

Cautions are indicated when mishandling this product might result in minor injury to the user, or only physical damage to the product.

■ Examples

	Use caution when handling the product.
	The indicated action is prohibited.
	Be sure to follow the indicated instructions.

WARNING



Do not disassemble the SDC35/36.
Doing so might cause electric shock or faulty operation.



Before removing, mounting, or wiring the SDC35/36, be sure to turn off the power to the SDC35/36 and all connected devices. Failure to do so might cause electric shock.



Do not touch electrically charged parts such as the power terminals.
Doing so might cause electric shock.

CAUTION



Use the SDC35/36 within the operating ranges recommended in the specifications (temperature, humidity, voltage, vibration, shock, mounting direction, atmosphere, etc.).



Do not block ventilation holes.
Doing so might cause fire or faulty operation.



Wire the SDC35/36 properly according to predetermined standards. Also wire the SDC35/36 using specified power leads according to recognized installation methods.
Failure to do so might cause electric shock, fire or faulty operation.



Do not allow lead clippings, chips or water to enter the controller case.
Doing so might cause fire or faulty operation.



Firmly tighten the terminal screws with the specified torque as listed in the specifications.
Insufficient tightening of terminal screws might cause electric shock or fire.



Do not use unused/spare terminals on the SDC35/36 as relay terminals.
Doing so might cause electric shock, fire, or faulty operation.



We recommend attaching the terminal cover (sold separately) after wiring the SDC35/36.
Failure to do so might cause electric shock, fire, or faulty operation.



Use the relays within the recommended life.
Failure to do so might cause fire or faulty operation.



If there is a risk of a power surge caused by lightning, use a surge absorber (surge protector) to prevent fire or device failure.



Do not make incorrect connections. If the cables are connected incorrectly, this might cause the unit to malfunction.



The controller requires 6 seconds to stabilize after power ON. Great care should be taken when the relay output from the controller is used as interlock signals.

CAUTION



The part between the control output 1 and control output 2 is not isolated. When necessary, use an appropriate isolator.



Do not connect multiple loader cables to multiple units from one personal computer. The current coming from other circuits might cause the PV value indication error to occur.



Do not connect any terminating resistor in the communication path when performing the RS-485 wiring. Doing so might cause the communication to fail.



Always mount a switch for shut-down of the main power of this unit in an area easily accessible to the operator when performing electric wiring of this unit. Additionally, connect a slow-action type (T) fuse having a rated current of 0.5A and rated voltage of 250V to the wiring for the instrument power supply of the AC power supply model. (IEC127)



Do not operate the key with a pencil or sharp-tipped object. Doing so might cause faulty operation.

The Role of This Manual

Four manuals are available for the SDC35/36 Single Loop Controller (hereafter referred to as "this unit"). Read appropriate manuals according to your requirements. If you do not have your required manual, contact the azbil Group or its dealer.

Additionally, you can download necessary manuals from "<http://www.azbil.com>".

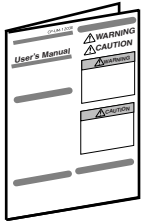

SDC35/36 Single Loop Controller User's Manual for Installation Manual No. CP-UM-5289JE

This manual is supplied with the product. Personnel in charge of design and/or manufacture of a system using this unit must thoroughly read this manual. This manual describes the safety precautions, installation, wiring, list of parameters, and primary specifications. For further information about operation, refer to another manual, Installation & Configuration.

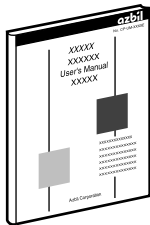

SDC35/36 Single Loop Controller User's Manual for Installation & Configuration Manual No. CP-SP-1150E

This manual. The manual describes the hardware and all functions of this unit. Personnel in charge of design, manufacture, operation, and/or maintenance of a system using this unit and those in charge of communication software of a system using the communication functions of this unit must thoroughly read this manual. This manual also describes the installation, wiring, connections for communication, all functions and settings of this unit, operating procedures, communication with host station, such as personal computer, communication addresses, troubleshooting, and detailed specifications.

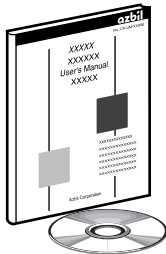

SLP-C35 Smart Loader Package for the SDC 15/25/26/35/36 Single Loop Controller User's Manual Manual No. CP-UM-5290E

This manual is supplied with the Smart Loader Package. The manual describes the software used to make various settings for SDC15/25/26/35/36 using a personal computer. Personnel in charge of design or setting of a system using SDC15/25/26/35/36 must thoroughly read this manual. The manual describes installation of the software into a personal computer, operation of the personal computer, various functions, and setup procedures.

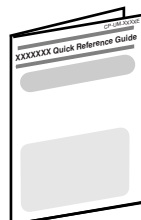

SDC35/36 Quick Reference Guide Manual No. CP-UM-1203E

For those using the SDC35/36 for the first time or for operators on the work site, this guide serves as a reference when setting or modifying parameters. Key operations, menu flowcharts and parameter settings are presented with color illustrations.

Organization of This User's Manual

This manual is organized as follows:

SDC35/36 Quick Reference Guide

This guide contains menu flowcharts, parameter settings lists, and concrete operation examples, with illustrations. Look at these pages first for an effective overview of the SDC35/36.

Chapter 1. OVERVIEW

This chapter describes the applications, features, model selection guide, and part names and functions of this unit. Since the part names described in this chapter are used in the subsequent descriptions, the part names and functions of this unit must be understood correctly in this chapter.

Chapter 2. OUTLINE OF FUNCTIONS

This chapter describes the outline and operation flow of the functions of this unit.

Chapter 3. INSTALLATION

This chapter describes the environmental conditions, installation dimensions, installation procedures, and necessary tools when installing this unit.

Chapter 4. WIRING

This chapter describes the wiring procedures, wiring precautions, and connection examples.

Chapter 5. DETAILED DESCRIPTION OF EACH FUNCTION

This chapter describes each function of this unit in detail.

Chapter 6. LIST OF DISPLAYS AND SETTING DATA

This chapter lists up the display items of this unit and their contents.

Chapter 7. CPL COMMUNICATION FUNCTION

This chapter describes how to communicate this unit with a host unit, such as a personal computer or PLC through Azbil Corporation's standard CPL communication using RS-485.

Chapter 8. Modbus COMMUNICATION FUNCTION

This chapter describes how to communicate this unit with a host unit, such as a personal computer or PLC through Modbus communication.

Chapter 9. LIST OF COMMUNICATION DATA

This chapter shows the list of communication data inside the memory of this unit.

Chapter 10. MAINTENANCE AND TROUBLESHOOTING

This chapter describes the maintenance and inspection of this unit, as well as troubleshooting.

Chapter 11. CALIBRATION

This chapter describes how to calibrate this unit in order to keep the accuracy and to safely operate this unit for an extended period of time.

Chapter 12. DISPOSAL

This chapter describes safety precautions and how to dispose of this unit when the unit is no longer used.

Chapter 13. SPECIFICATIONS

This chapter describes the general specifications, performance specifications, and optional parts of this unit.

Contents

SAFETY REQUIREMENTS	
SAFETY PRECAUTIONS	
The Role of This Manual	
Organization of This User's Manual	
Conventions Used in This Manual	

SDC35/36 Quick Reference Guide

Part names	D-1
Flowchart of key operations and displays	D-2 to D-3
Operations example	D-4 to D-5
List of parameter	D-6 to D-7
PV input range table	D-8
List of alarm code	D-8
Event type	D-8

Chapter 1. OVERVIEW

1-1 Overview	1-1
■ Model selection table	1-2
■ Accessories and optional parts	1-3
1-2 Part Names and Functions	1-4
■ Main body and console	1-4
■ Rear panel	1-7

Chapter 2. OUTLINE OF FUNCTIONS

2-1 Input/Output Configuration	2-1
2-2 Key Operation	2-2
■ Data setting procedures	2-4
■ [mode] key operating procedures	2-7
■ User level	2-7
2-3 Operation Modes	2-8

Chapter 3. INSTALLATION

■ Installation locations	3-1
■ External dimensions	3-1
■ Panel cutout dimensions	3-2
■ Mounting procedures	3-3

Chapter 4. WIRING

4-1	Wiring	4-1
■	Terminal assignment label symbols	4-2
■	Wiring precautions	4-2
■	Connection of open collector output to digital input	4-5
■	Connection of communication (RS-485) cable	4-5
■	Connection with solid state relay (SSR)	4-7
■	Connection method for the motor drive relay output (R1)	4-10
■	Connection with current-input type controllers	4-10
■	Wiring with zener barriers	4-11
■	Noise preventive measures	4-11
4-2	Recommended Cables	4-12

Chapter 5. DETAILED DESCRIPTION OF EACH FUNCTION

5-1	PV Input	5-1
■	PV input range type	5-2
■	Temperature unit	5-4
■	Cold junction compensation (T/C)	5-4
■	PV square root extraction dropout	5-4
■	Decimal point position	5-5
■	PV input range low limit/high limit	5-6
■	PV ratio and PV bias	5-6
■	PV low limit alarm threshold	5-6
■	PV filter	5-7
■	PV hold	5-7
■	PV low limit/high limit and PV low limit/high limit alarms	5-7
■	Zener barrier adjustment	5-8
5-2	Mode	5-10
■	AUTO/MANUAL mode	5-10
■	RUN/READY mode	5-10
■	LSP/RSP mode	5-10
■	Auto tuning (AT) stop/start	5-11
■	Release all digital output (DO) latches	5-11
■	Communication digital input 1 (communication DI 1)	5-11
5-3	Control	5-12
■	Control method	5-14
■	Control action and Heat/Cool control	5-15
■	Special control outputs	5-15
■	MANUAL mode change	5-16
■	PID control initialization	5-16
■	Initial output of PID control	5-17
■	PID decimal point position	5-17
■	ON/OFF control	5-18
■	Output variation limit	5-18
■	PID control	5-19
■	Zone PID	5-23
■	Heat/Cool control	5-24
■	Auto tuning (AT)	5-26

	■ Just-FITTER	5-28
	■ RationalLOOP	5-28
	■ SP lag	5-28
5-4	Auto Tuning (AT) Function	5-29
	■ Starting procedures	5-29
	■ Stopping procedures	5-29
5-5	Set Point (SP)	5-32
	■ SP setup in operation display mode	5-33
	■ LSP system group	5-33
	■ SP ramp type	5-33
	■ RSP input type	5-33
	■ RSP input range low limit/high limit	5-34
	■ RSP ratio and RSP bias	5-34
	■ RSP filter	5-35
	■ RSP low limit/high limit and RSP low limit/high limit alarms	5-35
	■ RSP and LSP1 to 8	5-35
	■ PID group number	5-36
	■ LSP group number	5-36
	■ DI Assignment of LSP group selection	5-37
	■ SP ramp unit	5-38
	■ SP ramp-up/ramp-down	5-38
	■ SP multi-ramp	5-40
	■ SP low limit/high limit	5-42
	■ DI Assignment of SP ramp enabled/disabled	5-42
5-6	Step Operation	5-43
	■ LSP system group	5-43
	■ SP ramp type	5-44
	■ SP ramp unit	5-45
	■ STEP time unit	5-45
	■ STEP PV start	5-46
	■ STEP loop	5-47
	■ STEP operation LSP, PID group No., ramp, time	5-48
	■ Operation type of internal contact	5-50
5-7	Digital Input (DI) and Internal Contact	5-51
	■ Operation type	5-52
	■ Event channel definitions	5-53
	■ Input bit function	5-54
	■ Input assignment	5-55
	■ Polarity of input assignment	5-56
	■ Polarity of input bit function	5-57
	■ DI Assignment setting with the SLP-C35 Smart Loader Package	5-57
5-8	Internal Event	5-58
	■ Operation	5-59
	■ Operation type	5-65
	■ Direct/reverse, standby, and EVENT state at READY	5-66
	■ Alarm OR, special OFF setup, and delay time unit	5-67
	■ Main setting, sub setting, and hysteresis	5-68
	■ ON delay and OFF delay	5-69
5-9	Digital Output (DO)	5-71
	■ MV1/MV2 process	5-72

■	Operation type	5-74
■	Output assignment	5-75
■	Polarity of output assignment	5-77
■	Polarity of output bit function	5-78
■	Latch	5-78
■	DO Assignment setting with the SLP-C35 Smart Loader Package	5-79
5-10	Application Examples	5-80
■	Examples of applications using assignment functions	5-80
5-11	Continuous Output	5-87
■	Output range	5-87
■	Output type	5-87
■	Output scaling low limit/high limit	5-88
■	MV scaling range	5-89
5-12	Current Transformer (CT) Input	5-90
■	CT type	5-91
■	CT output	5-91
■	CT measurement wait time	5-91
■	Number of CT turns and number of CT power wire loops	5-92
5-13	Console Display and Key Operation	5-94
■	Key operation type	5-94
■	[mode] key function	5-94
■	MODE display setup	5-95
■	PV/SP display setup	5-96
■	MV display setup	5-97
■	EV display setup	5-98
■	Timer remaining time display setup	5-98
■	CT display setup	5-99
■	User level	5-99
■	Communication monitoring display	5-99
■	Multi Status (MS) display	5-100
■	User Function	5-103
■	Key lock, communications lock, and loader lock	5-107
■	Password	5-108
5-14	Position Proportional Control	5-109
■	Position proportional type	5-109
■	Position proportional deadband	5-111
■	Motor long life mode	5-111
■	Motor auto adjust	5-111
■	Motor wiring and motor auto adjust operation	5-113
■	Input with motor fully closed and input with motor fully open	5-115
■	Motor full close–full open time	5-115

Chapter 6. LIST OF DISPLAYS AND SETTING DATA

6-1	List of Operation Displays	6-1
■	Operation displays	6-1
6-2	List of Parameter Setting Displays	6-3
■	Mode bank	6-3
■	SP bank	6-4

■	Event bank	6-5
■	PID bank	6-7
■	Parameter bank	6-10
■	Extended tuning bank	6-11
■	Zone bank	6-11
6-3	List of Setup Setting Displays	6-12
■	Setup bank	6-12
■	Event configuration bank	6-19
■	DI Assignment bank	6-22
■	DO Assignment bank	6-26
■	User Function bank	6-29
■	Lock bank	6-30
■	Instrument information bank	6-30

Chapter 7. CPL COMMUNICATION FUNCTION

7-1	Outline of Communication	7-1
■	Features	7-1
■	Setup	7-1
■	Communication procedures	7-2
7-2	Message Structure	7-3
■	Message structure	7-3
■	Data link layer	7-3
■	Application layer	7-6
7-3	Description of Commands	7-7
■	Continuous data read command (RS command)	7-7
■	Continuous data write command (WS command)	7-8
■	Fixed length continuous data read command (RD command)	7-9
■	Fixed length continuous data write command (WD command)	7-10
■	Fixed length random data read command (RU command)	7-11
■	Fixed length random data write command (WU command)	7-12
7-4	Definition of Data Addresses	7-13
7-5	Numeric Representation in the Application Layer	7-14
7-6	List of Termination Codes	7-15
7-7	Reception and Transmission Timing	7-16
■	Timing specifications for instruction and response message	7-16
■	RS-485 driver control timing specifications	7-16
7-8	Cautions when Executing Communication Programs for the Master Station	7-17
■	Example of communication program	7-17

Chapter 8. Modbus COMMUNICATION FUNCTION

8-1	Outline of Communication	8-1
■	Features	8-1
■	Setup	8-1
■	Communication procedures	8-2

8-2	Message Structure	8-3
■	Message structure	8-3
■	Command type	8-6
■	Other specifications	8-6
8-3	Description of Commands	8-7
■	Read command (03H)	8-7
■	Write command (10H)	8-9
8-4	Specifications Common with CPL Communication Function	8-11
■	Definition of data addresses	8-11
■	Numeric representation	8-11
■	RS-485 driver control timing specifications	8-11

Chapter 9. LIST OF COMMUNICATION DATA

■	List of communication data	9-1
---	----------------------------------	-----

Chapter 10. MAINTENANCE AND TROUBLESHOOTING

■	Maintenance	10-1
■	Alarm displays and corrective action	10-2
■	Behavior in case of PV input failure	10-3
■	Behavior in case of RSP input failure	10-4

Chapter 11. CALIBRATION

■	Starting the calibration	11-1
■	Exiting the calibration	11-1
■	Cautions before starting the calibration	11-2
■	Measuring instruments required for calibration	11-2
■	Calibration procedures	11-2

Chapter 12. DISPOSAL

Chapter 13. SPECIFICATIONS

■	Specifications	13-1
■	Accessories and optional parts	13-7

Appendix

Glossary	Appendix-1
----------------	------------

Index

Conventions Used in This Manual

The following conventions are used in this manual:

Handling Precautions

: Handling Precautions indicate items that the user should pay attention to when handling the SDC35/36.



: This indicates the item or page that the user is requested to refer to.

Note

: Notes indicate useful user tips and information.

(1), (2), (3) : The numbers with the parenthesis indicate steps in a sequence or indicate corresponding parts in an explanation.

[para], [mode] etc. : These indicate keys on the keyboard of this unit, and messages and menus that appear on the personal computer screen.

>> : This indicates the operation results and the status after operation.

● Numeric value and character display on LED

Numeric values The 7-segment LED expresses numeric values as follows:

0		1		2		3		4	
5		6		7		8		9	

Alphabetical characters The 7-segment LED expresses alphabetical characters shown below. There are some alphabetical characters, which are not displayed on the LED.

A		B		C		D		E	
a		b		c		d		e	
F		G		H		I		J	
f		g		h		i		j	
K		L		M		N		O	
k		l		m		n		o	
P		Q		R		S		T	
p		q		r		s		t	
U		V		Y		Z		-	
u		v		y		z			

Handling Precautions

As shown above, numeric value "2" and alphabetic character "Z" are shown in the same manner.

Accordingly, numeric value "5" and alphabetic character "S", as well as numeric value "9" and alphabetic character "Q" are also shown in the same manner.

SDC35/36 Quick Reference Guide

This guide offers flowchart and list of parameters, and operation examples on pages D-1 to D-8.

If more detailed information on the SDC35/36 is needed, refer to the text.

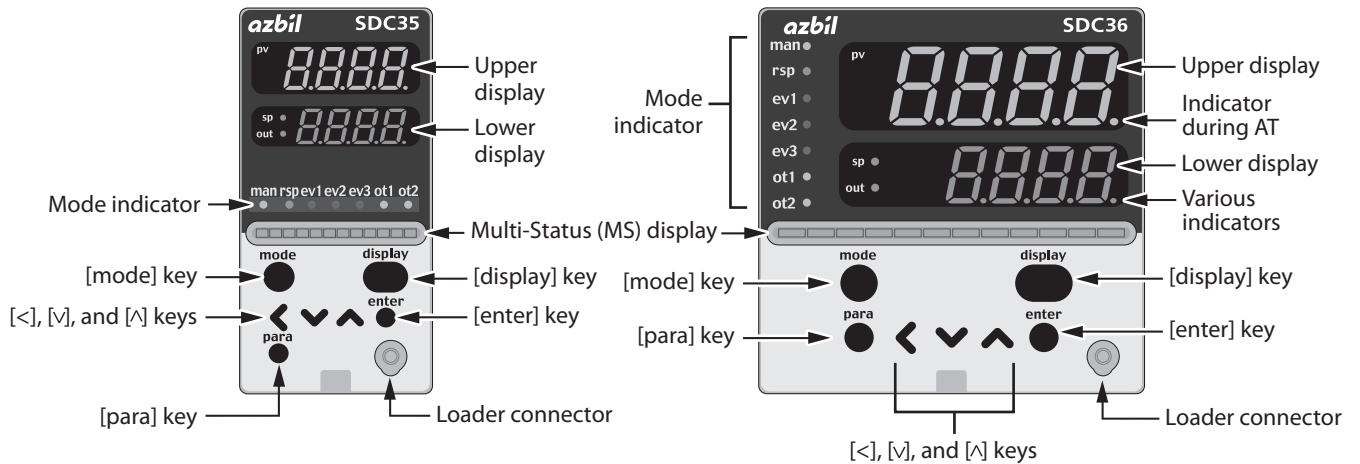

Upper display	This display shows either the PV value or the display value and set value for each displayed item. If an alarm is triggered, the normal display and alarm code are displayed alternately. During auto tuning (AT), the rightmost decimal point flashes twice repeatedly.
Lower display	This display shows either the SP/MV/CT or the display value and set value for each displayed item. The decimal point at the right end digit shows the RUN/READY mode or communication status.
Multi-Status (MS) display	Turns ON in READY mode or when an alarm occurs, depending on the ON conditions and the current status. When lit, in addition to flashing and reciprocating between left and right, it performs MV graph, DI monitor, internal event monitor, and other display functions.
Mode indicators	<p>man: Lights when MANUAL (AUTO mode if not lit)</p> <p>rsp: Lights when RSP</p> <p>ev1, ev2, ev3: Lights when event relays are ON</p> <p>ot1, ot2: Lights when the control output is ON (always lit when the current output is used)</p>
[mode] key	<ul style="list-style-type: none"> When this key is pressed and held for more than 1 second in the operation display mode, any of the following operations from 0 to 7 which have been set previously can be executed <ul style="list-style-type: none"> 0: Mode key does not operate 1: AUTO/MANUAL mode selection (Initial value) 2: RUN/READY mode selection 3: AT (Auto Tuning) start/stop selection 4: LSP (Local SP) group selection 5: Release all DO (Digital Output) latches 6: LSP/RSP mode selection 7: ON/OFF selection of communication DI When pressing the [mode] key in the setup display mode, the display is changed to the operation display
[display] key	This key is used to change the display item in the operation display mode. When pressing this key in the bank selection, bank setup, or user function setup display mode, the display is changed to the operation display.
[para] key	When this key is kept pressed for 2 sec. or longer in the operation display mode, the display is then changed to the setup display.
[<], [V], [^] keys	These keys are used to increase or decrease the numeric value, or to shift the digit. The [V] and [^] keys are used to change the bank or display item.
[enter] key	This key is used to begin changing settings (display goes from lit to flashing) and to finalize new settings (display goes from flashing to steadily lit).
Loader connector	This connector is used for connecting to a personal computer using the dedicated cable supplied with the Smart Loader Package.

Flowchart of key operations and displays

When the power is turned ON



Upper and lower displays remain off for 5 s after power ON. Each mode indicator lights sequentially, and then the operation display appears.

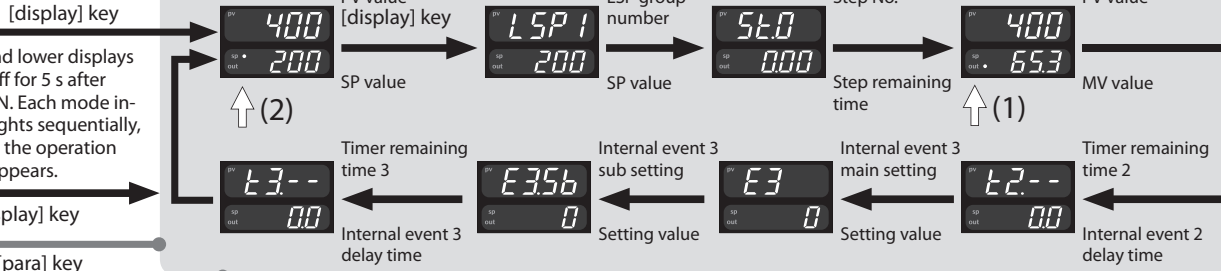

User function

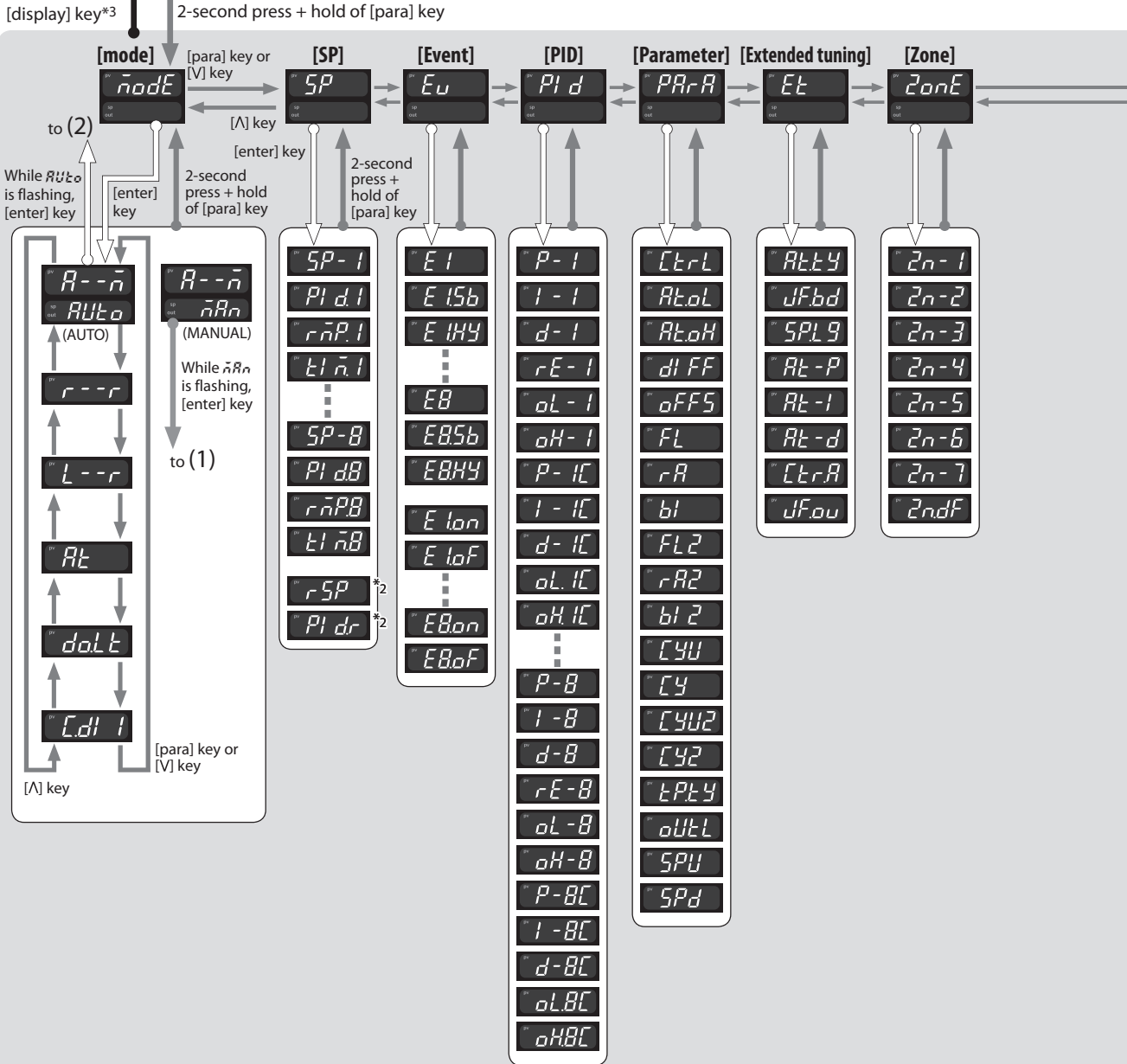
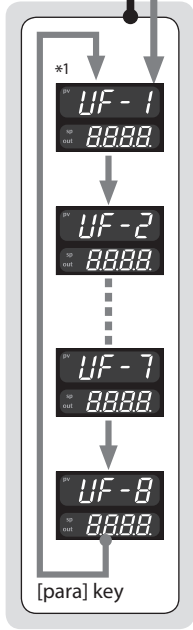

- Some items are not displayed depending on the availability of optional functions, model number, display setup (C73 to C78) and display level (C79).
- Pressing [display] while bank item or user function item is displayed has the effect of canceling and returning to the operation display item.

Operation displays

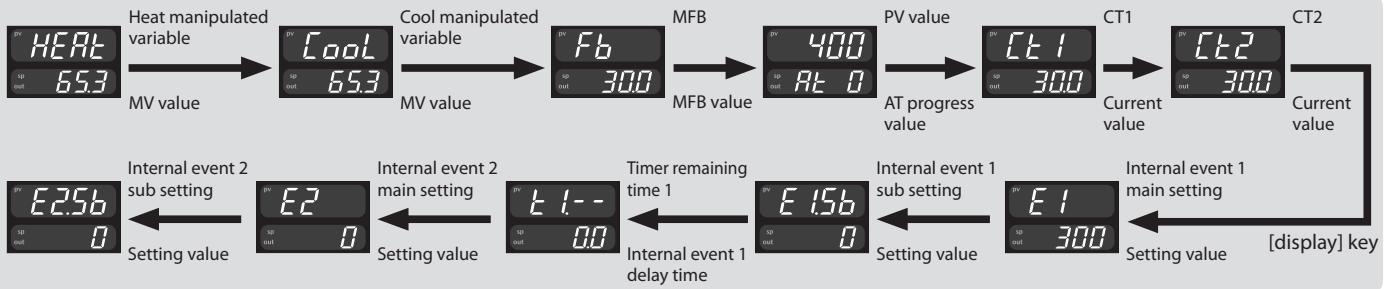

Setting displays

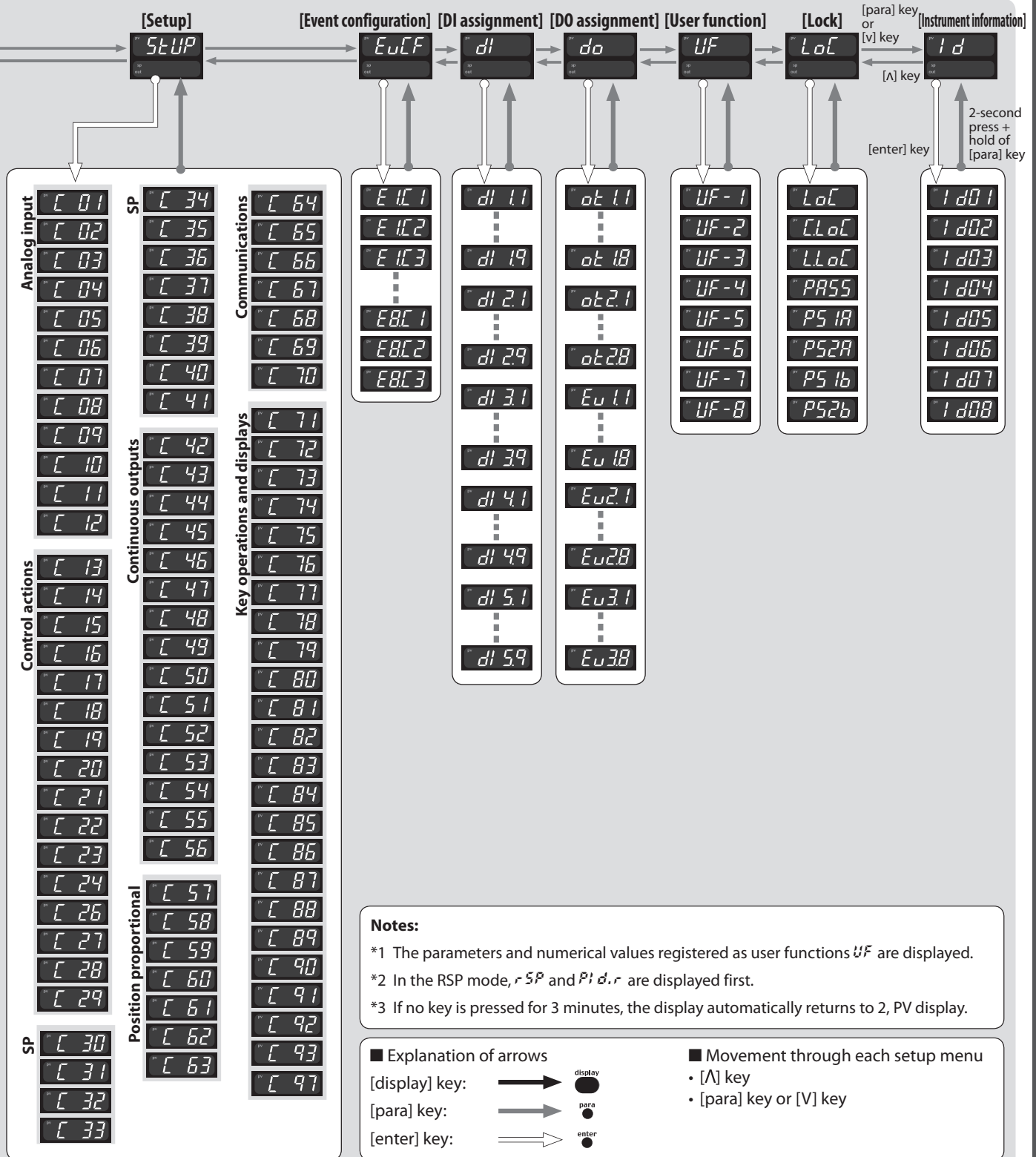

- Notes:**
- *1 The parameters and numerical values registered as user functions *UF* are displayed.
 - *2 In the RSP mode, *rSP* and *P1 d.r* are displayed first.
 - *3 If no key is pressed for 3 minutes, the display automatically returns to 2, PV display.

Explanation of arrows

- [display] key:
- [para] key:
- [enter] key:

Movement through each setup menu





- [A] key
- [para] key or [V] key

Operation examples

Black letters : Items before operation







White letters : Items during operation

Setup of PV input range type

<p>1 Press [display] once to get the operation display.</p> <p>If no sensor is connected, an alarm for abnormal PV input (any one from $R\bar{L}0$ to $R\bar{L}4$) may appear on the upper display.</p> 	<p>2 Press and hold [para] for more than 2 s to get the parameter setup display. $\bar{n}o\bar{d}E$ flashes on the upper display.</p> 
<p>3 Press [V] or [Λ] repeatedly, and $S\bar{L}U\bar{P}$ flashes on the upper display.</p> 	<p>4 Press [enter]. The current set value for $\bar{L}0$ (PV input range type) is displayed.</p> 
<p>5 Press [enter]. The rightmost digit on the lower display flashes and its value can be changed. Press [<], [V] or [Λ] to change to the desired sensor type in the PV input range list. Then press [enter] to finalize your selection. (If the number is flashing, the [enter] key has not yet been pressed, and the setting has not yet been saved.)</p> 	

Setup of event operation type







In this example, the event 1 operation type is set to deviation high limit.

<p>1 Press [display] once to get the operation display.</p> 	<p>2 Press and hold [para] for more than 2 s to get the parameter setup display. $\bar{n}o\bar{d}E$ flashes on the upper display.</p> 
<p>3 Press [V] or [Λ] repeatedly to get $E\bar{U}\bar{L}\bar{F}$ flashing on the upper display.</p> 	<p>4 Press [enter] to get $E\bar{L}\bar{L}\bar{I}$ on the upper display and $\bar{0}$ is displayed on the lower display.</p> <p>$\bar{0}$ on the lower display indicates that the event operation type is set to "none."</p> 
<p>5 When [enter] is pressed, the rightmost digit on the lower display flashes. Press [V] or [Λ] to get $\bar{4}$ flashing on the display.</p> <p>$\bar{4}$ on the lower display indicates that the event operation type is set for deviation high limit.</p> 	<p>6 Press [enter], and the displayed value $\bar{4}$ on the lower display changes from flashing to continuously lit and the displayed value is set.</p> 



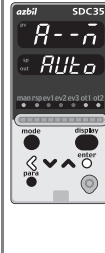

Similarly, use $E\bar{2}\bar{L}\bar{I}$ to set the event 2 operation type, and use $E\bar{3}\bar{L}\bar{I}$ for event 3

Execution of auto tuning (AT)

AT forces ON/OFF of the MV a number of times (a limit cycle) to calculate PID values. Check that this operation does not create any problems for the associated equipment before executing AT.

<p>1 Press [display] once to get the operation display.</p> 	<p>2 Press and hold [para] for more than 2 s to get the parameter setup display. $\bar{n}o\bar{d}E$ flashes on the upper display.</p> 
<p>3 Press [enter] or [<] to get $R-\bar{n}$ on the upper display and $R\bar{U}\bar{L}\bar{O}$ on the lower display.</p> <p>If the control method is ON/OFF control and if Bit 3 (AT stop/start display) of the mode display setting ($\bar{L}73$) is set to "disabled: 0," nothing is displayed.</p> 	<p>4 Press [V] as needed until $R\bar{L}$ and $R\bar{L}\bar{O}\bar{F}$ appear on the upper and lower displays respectively.</p> 
<p>5 When [enter] is pressed, $R\bar{L}\bar{O}\bar{F}$ flashes on the lower display.</p> <p>The display flashes only in RUN and AUTO modes, and only if there is no PV problem. Also, if DI is set to "AT stop/start", the display does not flash and the setting cannot be changed.</p> 	<p>6 Press [V] or [Λ] once, and $R\bar{L}\bar{O}\bar{F}$ flashes on the lower display.</p> 
<p>7 If [enter] is pressed, $R\bar{L}\bar{O}\bar{n}$ remains steadily lit and AT begins. During AT, the rightmost decimal point flashes twice repeatedly. (When AT is done, the light goes off and the new PID values go into effect.)</p> <p>During the AT process, if the mode is changed to READY or MANUAL, if PV input is faulty, or if a power failure occurs, AT stops automatically without changing the PID values. AT can also be stopped by changing the setting from $R\bar{L}\bar{O}\bar{n}$ to $R\bar{L}\bar{O}\bar{F}$ (return to step 4 above).</p> 	

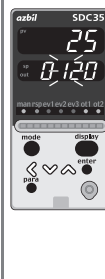



Setup of SP value

<p>1 Press [display] repeatedly so that the orange SP indicator lights up on the lower display. The operation display now shows the SP.</p> 	<p>2 If [enter] is pressed, the rightmost digit on the lower display flashes and numerical value can be changed.</p> 
<p>3 Press [<], [V] or [Λ] to change to the desired SP value. The flashing of the number indicates that the setting has not yet been finalized.</p> <p>If an SP limit is in effect, the numerical value cannot be changed to a value above the limit. The SP limit must be changed first.</p> 	<p>4 If [enter] is pressed, the displayed value is set and the display changes from flashing to continuously lit.</p> <p>If the [display] key is pressed without pressing [enter] key, the status returns to that of step 1.</p> 

For step numbers that are highlighted (e.g., **4**), the following precaution applies:







- If the key lock is set, the numerical value does not flash, and the value cannot be changed. To change a numerical value, cancel the key lock first.

AUTO/MANUAL mode selection

<p>1</p> <p>Press [display] once to get the operation display.</p> <p>The [mode] key can be used for 1 of 7 different operations. The initial (factory) setting is "AUTO/MANUAL selection".</p> 	<p>2</p> <p>Press and hold [mode] for more than 2 s, $\tilde{n}\tilde{a}\tilde{n}$ flashes on the lower display.</p> <p>If the control method is set to "ON/OFF control" and if the DI assignment is "AUTO/MANUAL," the display does not blink and the setting cannot be changed.</p> 
<p>3</p> <p>When Man appears, stop pressing [mode]. The MV is shown on the lower display. The rightmost digit of the MV on the lower display flashes and its value can be changed.</p> 	<p>4</p> <p>Press [<], [V] or [Λ] to change to the desired MV value. Even while the number is flashing, the MV is changed at the same time that the number is changed.</p> 

For the flashing MV in step 3, either bumpless transition (the same value as before the change) or preset MANUAL value (the value set in setup $\zeta 20$) can be selected (in setup $\zeta 19$, Output operation after AUTO-MANUAL change).









Execution of position proportional control auto adjust

<p>1</p> <p>Press [display] once to get the operation display.</p> 	<p>2</p> <p>Press and hold [para] for more than 2 s to get the parameter setup display. $\tilde{n}\tilde{o}\tilde{d}\tilde{E}$ flashes on the upper display.</p> 
<p>3</p> <p>Press [V] or [Λ] repeatedly until $\zeta 5tUP$ is flashing on the upper display.</p> 	<p>4</p> <p>Press [enter] to get $\zeta 0 /$ on the upper display. Press [<], [V] or [Λ] to change to $\zeta 60$. ($\zeta 60$: position proportional control auto adjust)</p> 
<p>5</p> <p>If [enter] is pressed, the lower display flashes. Press [V] or [Λ] to get ζ. Press [enter] and auto adjust starts.</p> 	<p>6</p> <p>$\zeta R.0L$ is displayed on the upper display and open contact is ON. The lower display shows the MFB count value and when count is stable, $\zeta R.0P$ is displayed on the upper display and closed contact is ON. When the count value is stable, auto adjust completes to get operation display.</p> 

After starting auto adjust, press [display] key to stop auto adjust. During auto adjust the key operation except [display] key of stopping auto adjust is impossible.

Setup of event value

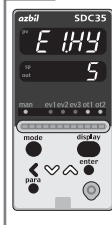
In this example, the event set value and hysteresis for the event 1 operation type is set to deviation high limit.

<p>1</p> <p>Press [display] once to get the operation display.</p> 	<p>2</p> <p>Press and hold [para] for more than 2 s to get the parameter setup display. $\tilde{n}\tilde{o}\tilde{d}\tilde{E}$ flashes on the upper display.</p> 
<p>3</p> <p>Press [V] twice or [Λ] repeatedly, and ζW flashes on the upper display.</p> 	<p>4</p> <p>Press [enter] to get $\zeta 1$ on the upper display and ζ is displayed on the lower display.</p> <p>ζ on the lower display indicates that the event main setting is "0".</p> 
<p>5</p> <p>If [enter] is pressed, the rightmost digit on the lower display flashes, and can be changed. Press [<], [V], or [Λ], and change to the desired value for event set value. In this case, the flashing of the numerical value implies that it is not yet set.</p> 	<p>6</p> <p>If [enter] is pressed, the changed numerical value is set and changes from flashing to continuously lit.</p> 
<p>Similarly, use $\zeta 2$ to set a value for event 2, and $\zeta 3$ to set a value for event 3.</p>	
<p>7</p> <p>To continue from this point and set hysteresis as well, press [V] twice or [Λ] repeatedly to get $\zeta 1.HY$ on the upper display. The lower display says 5.</p> <p>5 on the lower display indicates that the event hysteresis is "5".</p> 	<p>8</p> <p>In the same way that event settings were changed, press [enter] to make the number flash, and then press [<], [V] or [Λ] to change to the desired setting for hysteresis. After that, press [enter] to finalize the setting.</p> 

Similarly, use $\zeta 2.HY$ to set a value for event 2, and $\zeta 3.HY$ to set a value for event 3.

Memo

List of parameter

- : Essential parameters for PV measurement and control
- : Basic parameters
- : Required parameters when using optional functions

List of operation displays

Display	Item	Contents	Initial value	Setting value
PV	SP	SP (Target value)	SP low limit to SP high limit	0
LSP #1	LSP	LSP group number *2	1 to LSP system group (Max. 4)	1
Lt-#1	LSP	Step operation remaining time	Setting is disabled. The step No. distinguishes up ramp, down ramp, and soak.	—
PV	MV	MV (Manipulated Variable)	-10.0 to +110.0 % Setting is enabled in MANUAL mode (Numeric value flashed)	—
HEV	Numeric value	Heat MV (Manipulated Variable)	Setting is disabled.	—
COV	Numeric value	Cool MV (Manipulated Variable)	-10.0 to +110.0 %	—
PV	AT #1	AT progress display *2	Setting is disabled.	—
CT1	Numeric value	CT current value 1	Setting is disabled.	—
CT2	Numeric value	CT current value 2	Setting is disabled.	—
E1	Numeric value	Internal Event 1 main setting	-1999 to +9999 U or 0 to 9999 U	0
E1.Sb	Numeric value	Internal Event 1 sub setting	—	0
Lt-#1	Numeric value	Internal Event 1 remaining time	Setting is disabled.*3	—
E2	Numeric value	Internal Event 2 main setting	Same as Internal Event 1 main setting	0
E2.Sb	Numeric value	Internal Event 2 sub setting	Same as Internal Event 1 sub setting	0
Lt-#1	Numeric value	Internal Event 2 remaining time	Same as Internal Event 1 remaining time	—
E3	Numeric value	Internal Event 3 main setting	Same as Internal Event 1 main setting	0
E3.Sb	Numeric value	Internal Event 3 sub setting	Same as Internal Event 1 sub setting	0
Lt-#1	Numeric value	Internal Event 3 remaining time	Same as Internal Event 1 remaining time	—

*1. Display example *2. 1st digit—the right end digit
 *3. "r" is displayed at the right end digit when using the ON delay time, and "L", the OFF delay time.

List of parameter setting displays

Mode bank

Display	Item	Contents	Initial value	Setting value
A-#	AUTO/MANUAL	Run mode: AUTO mode Stop mode: MANUAL mode	AUTO	—
R-#	RUN/READY	Run mode: RUN mode Ready mode: READY mode	RUN	—
L-#	LSP/RSP	LSP: LSP RSP: RSP	LSP	—
AT	AT stop/start	AT stop: AT stop AT start: AT start	AT stop	—
DO.Lt	Release all DO latches	Lt.on: Latch continue Lt.off: Latch release	Latch continue	—
DI.#	Communication DI1	DI.off: OFF DI.on: ON	OFF	—

SP bank

Display	Item	Contents	Initial value	Setting value
rSP	RSP	Setting is disabled.	—	—
P1.#	PID group number (RSP)	1-8	1	—
SP-1-#	SP of LSP 1 group to 8 group	SP low limit to SP high limit	0	—
P1.d-1-#	PID group number (LSP 1-8)	1-8	1	—
rSP-1-#	Ramp (LSP 1-8)	0-9999	0	—
Lt-1-#	Time (LSP 1-8)	0.0-999.9 or 0-9999	0	—

Event bank

Display	Item	Contents	Initial value	Setting value
E1-#	Internal Event 1-8 main setting	-1999 to +9999 or 0 to 9999*	0	—
E1.Sb-#	Internal Event 1-8 sub setting	—	0	—
E1.Hy-#	Internal Event 1-8 hysteresis	0 to 9999*	5	—
E1.on-#	Internal Event 1-8 ON delay time	0.0 to 999.9 or 0 to 9999	0	—
E1.off-#	Internal Event 1-8 OFF delay time	—	0	—

*The decimal point position may vary so that it meets the operation type of the internal event

PID bank

Display	Item	Contents	Initial value	Setting value
P-#	Proportional band (PID-#)	0.1 to 999.9 %	5.0	—
I-#	Integral time (PID-#)	0 to 9999 s*	120	—
D-#	Derivative time (PID-#)	0 to 9999 s*	30	—
r-#	Manual reset (PID-#)	-10.0 to +110.0 %	0.0	—
oL-#	MV low limit (PID-#)	-10.0 to +110.0 %	50.0	—
oH-#	MV high limit (PID-#)	-10.0 to +110.0 %	100.0	—
P-#-C	Proportional band (cool) (PID-#)	0.1 to 999.9 %	5.0	—
I-#-C	Integral time (cool) (PID-#)	0 to 9999 s*	120	—
D-#-C	Derivative time (cool) (PID-#)	0 to 9999 s*	30	—
oL-#-C	Output low limit (cool) (PID-#)	-10.0 to +110.0 %	0.0	—
oH-#-C	Output high limit (cool) (PID-#)	-10.0 to +110.0 %	100.0	—

*No integration control action when set at "0"

Parameter bank

Display	Item	Contents	Initial value	Setting value
Control	Control method	0: ON/OFF control 1: Fixed PID	0 or 1	—
Control	MV low limit at AT	-10.0 to +110.0 %	0.0	—
Control	MV high limit at AT	-10.0 to +110.0 %	100.0	—
Control	Differential (for ON/OFF control)	0-9999 U	5	—
Control	ON/OFF control action point offset	-1999 to +9999 U	0	—
PV	PV filter	0.0-120.0 s	0.0	—
PV	PV ratio	0.001-9.999	1.000	—
PV	PV bias	-1999 to +9999 U	0	—
PV	RSP filter	0.0-120.0 s	0.0	—
PV	RSP ratio	0.001-9.999	1.000	—
PV	RSP bias	-1999 to +9999 U	0	—
Time proportional output	Time proportional cycle unit 1	0: 1 s unit 1: Cycle fixed at 0.5 s 2: Cycle fixed at 0.25 s 3: Cycle fixed at 0.1 s	0	—
Time proportional output	Time proportional cycle 1	5-120 s or 1-120 s*	10 or 2	—
Time proportional output	Time proportional cycle unit 2	0: 1 s unit 1: Cycle fixed at 0.5 s 2: Cycle fixed at 0.25 s 3: Cycle fixed at 0.1 s	0	—
Time proportional output	Time proportional cycle 2	5-120 s or 1-120 s*	10 or 2	—
Time proportional output	Time proportional cycle mode	0: Controllability aiming type 1: Operation end service life aiming type (Only ON/OFF operation within Time proportional cycle)	0 or 1	—
SP	SP up ramp	0.0-999.9 U (No ramp when set at "0.0 U")	0.0	—
SP	SP down ramp	—	0.0	—

* 5-120 s when output includes the relay output
 U: Unit Maximum unit of Industrial volume in PV range (°C, Pa, L/min, etc.)

Extended tuning bank

Display	Item	Contents	Initial value	Setting value
AT	AT type	0: Normal 1: Immediate response 2: Stable*	1	—
JF.bd	Just-FITTER settling band	0.0-10.00	0.30	—
SP.LS	SP lag constant	0.0-999.9	0.0	—
AT-P	Proportional band tuning factor at AT	0.0-99.99	1.00	—
AT-I	Integral time adjust at AT	0.0-99.99	1.00	—
AT-D	AT Derivative time adjust	0.0-99.99	1.00	—
CT.R	Control algorithm	0: PID (Conventional PID) 1: Ra-PID (High-performance PID)	0	—
JF.ov	Just-FITTER overshoot suppression factor	0-100	0	—

* Normal=Standard control characteristics, Immediate response=Control characteristics that respond immediately to external disturbance, Stable=Control characteristics having less up/down fluctuation of PV

Zone bank

Display	Item	Contents	Initial value	Setting value
Zo-1-#	Zone 1-7	-1999 to +9999 U	9999 U	—
Zo.H	Zone hysteresis	0-9999	5 U	—

List of setup setting displays

Setup bank

Display	Item	Contents	Initial value	Setting value
ANALOG INPUT	PV input range type	For details, refer to the PV Input Range Table	88	—
ANALOG INPUT	Temperature unit	0: Celsius (°C) 1: Fahrenheit (°F)	0	—
ANALOG INPUT	Cold junction compensation	0: Performed (internal) 1: Not performed (external)	0	—
ANALOG INPUT	Decimal point position	0: No decimal point 1-3: 1-3 digits below decimal point	0	—
ANALOG INPUT	PV input range low limit	When the PV input type is DC voltage/DC current, -1999 to +9999 U	0	—
ANALOG INPUT	PV input range high limit	PV input range low limit to PV input range high limit	1000	—
ANALOG INPUT	SP low limit	—	0	—
ANALOG INPUT	SP high limit	—	1000	—
ANALOG INPUT	PV square root extraction dropout	0.0-100.0 % (PV square root extraction is not performed when set at "0.0")	0.0	—
ANALOG INPUT	RSP input type	0: 4-20 mA 1: 0-20 mA 2: 0-5 V 3: 1-5 V 4: 0-10 V	0	—
ANALOG INPUT	RSP input range low limit	-1999 to +9999 U	0	—
ANALOG INPUT	RSP input range high limit	—	1000	—
CONTROL ACTION	PID calculation adjustment function	0: Enabled 1: Disabled	0	—
CONTROL ACTION	Control action (Direct/Reverse)	0: Heat control (Reverse action) 1: Cool control (Direct action)	0	—
CONTROL ACTION	Output operation at PV alarm	0: Control calculation is continued. 1: Output at PV alarm is output.	0	—
CONTROL ACTION	Output at PV alarm	-10.0 to +110.0 %	0.0	—
CONTROL ACTION	Output at READY (Heat)	-10.0 to +110.0 %	0.0	—
CONTROL ACTION	Output at READY (Cool)	-10.0 to +110.0 %	0.0	—
CONTROL ACTION	Output operation at changing AUTO/MANUAL	0: Bumpless transfer 1: Preset	0	—
CONTROL ACTION	Preset MANUAL value	-10.0 to +110.0 %	0.0 or 50.0	—
CONTROL ACTION	Initial output type of PID control	0: Auto 1: Not initialized 2: Initialized	0	—
CONTROL ACTION	Initial output of PID control	-10.0 to +110.0 %	0.0 or 50.0	—
CONTROL ACTION	PID decimal point position (decimal point of integral time and derivative time)	0: No decimal point 1: 1 digit after decimal point	0	—
CONTROL ACTION	Zone PID operation	0: Disabled 1: Changed by SP 2: Changed by PV	0	—
CONTROL ACTION	Heat/Cool control	0: Not used 1: Used	0	—
CONTROL ACTION	Heat/Cool selection	0: Normal 1: Energy saving	0	—
CONTROL ACTION	Heat/Cool control dead zone	-100.0 to +100.0 %	0.0	—
CONTROL ACTION	Heat/Cool control change point	-10.0 to +110.0 %	50.0	—
CONTROL ACTION	LSP system group	1-4	1	—
CONTROL ACTION	SP ramp type	0: Standard 1: Multi-ramp 2: Step operation When the power is turned ON again, the step operation is stopped (READY) 3: Step operation When the power is turned ON again, the step operation is reset	0	—
CONTROL ACTION	SP ramp unit	0: 0.1 U/s 1: 0.1 U/min 2: 0.1 U/h	0	—
CONTROL ACTION	STEP time unit	0: 0.1 s 1: 1 s 2: 1 min	0	—
CONTROL ACTION	STEP PV start	0: None 1: Up start 2: Down start	0	—
CONTROL ACTION	STEP loop	0: Stop 1: Loop 2: Final step continued	0	—
CONTROL ACTION	CT1 operation type	0: Heater burnout detection 1: Current value measurement	0	—
CONTROL ACTION	CT1 output	0-1: Control output 1-2 2-4: Event output 1-3	0	—
CONTROL ACTION	CT1 measurement wait time	30-300 ms	30	—
CONTROL ACTION	CT2 operation type	Same as CT1	0	—
CONTROL ACTION	CT2 output	Same as CT1	0	—
CONTROL ACTION	CT2 measurement wait time	Same as CT1	30	—
CONTROL ACTION	Control output 1 range	1: 4-20 mA 2: 0-20 mA	1	—
CONTROL ACTION	Control output 1 type	0: MV 1: Heat MV 2: Cool MV 3: PV 4: PV before ratio, bias, and filter 5: SP 6: Deviation 7: CT1 current value 8: CT2 current value 10: SP+MV 11: PV+MV	0	—
CONTROL ACTION	Control output 1 scaling low limit	-1999 to +9999 U	0.0	—
CONTROL ACTION	Control output 1 scaling high limit	—	100.0	—
CONTROL ACTION	Control output 1 MV scaling	0-9999 (Valid when control output 1 type is 10 or 11)	200	—
CONTROL ACTION	Control output 2 range	Same as control output 1	1	—
CONTROL ACTION	Control output 2 type	Same as control output 1	3	—
CONTROL ACTION	Control output 2 scaling low limit	Same as control output 1	0	—
CONTROL ACTION	Control output 2 scaling high limit	Same as control output 1	1000	—
CONTROL ACTION	Control output 2 MV scaling	Same as control output 1	200	—
CONTROL ACTION	Auxiliary output range	Same as control output 1	1	—
CONTROL ACTION	Auxiliary type	Same as control output 1	3	—
CONTROL ACTION	Auxiliary output scaling low limit	Same as control output 1	0	—
CONTROL ACTION	Auxiliary output scaling high limit	Same as control output 1	1000	—
CONTROL ACTION	Auxiliary output MV scaling	Same as control output 1	200	—
CONTROL ACTION	Position proportional type	0: MFB control+Estimated position control 1: MFB control 2: Estimated position control (MFB disabled) 3: Estimated position control (MFB disabled)+Position adjustment at power ON.	0	—
CONTROL ACTION	Position proportional dead zone	0.5-25.0 %	10.0	—
CONTROL ACTION	Motor long life mode	0: Aiming at controllability 1: Aiming at service life of potentiometer	1	—
CONTROL ACTION	Motor auto adjust	0: Stop 1: Start	0	—
CONTROL ACTION	Input with motor fully closed	0-9999	1000	—
CONTROL ACTION	Input with motor fully open	0-9999	3000	—
CONTROL ACTION	Motor full close-full open	5.0-240.0 s	30.0	—
CONTROL ACTION	CPL/Modbus	0: CPL 1: Modbus (ASCII format) 2: Modbus (RTU format)	0	—
CONTROL ACTION	Station address	0-127 (Communication is disabled when set at "0")	2	—
CONTROL ACTION	Transmission speed (bps)	0: 4800 1: 9600 2: 19200 3: 38400	0	—
CONTROL ACTION	Data format (Data length)	0: 7 bits 1: 8 bits	1	—
CONTROL ACTION	Data format (Parity)	0: Even parity 1: Odd parity 2: No parity	0	—
CONTROL ACTION	Data format (Stop bit)	0: 1 bit 1: 2 bits	0	—
CONTROL ACTION	Response time-out	1-250 ms	3	—

Display	Item	Contents	Initial value	Setting value
℄ 71	● Key operation type	0: Standard type 1: Special type	0	
℄ 72	● [mode] key function	0: Invalid 1: AUTO/MANUAL selection 2: RUN/READY selection 3: AT Stop/Start 4: LSP group selection 5: Release all DO latches 6: Invalid 7: Communication DI1 selection 8: Invalid	0	
℄ 73	● MODE display setup (Sum of the weighting)	Bit 0: AUTO/MANUAL display (Enabled: +1) Bit 1: RUN/READY display (Enabled: +2) Bit 2: LSP/RSP display (Enabled: +4) Bit 3: AT Stop/Start display (Enabled: +8) Bit 4: Release all DO latches display (Enabled: +16) Bit 5: Communication DI1 ON/OFF display (Enabled: +32) Other invalid setting, 0, +64, +128	255	
℄ 74	● PV/SP display setup (Sum of the weighting)	Bit 0: PV display (Enabled: +1) Bit 1: SP display (Enabled: +2) Bit 2: LSP group number display (Enabled: +4) Other invalid setting, 0, +8	15	
℄ 75	● MV display setup (Sum of the weighting)	Bit 0: MV display (Enabled: +1) Bit 1: Heat MV/cool MV display (Enabled: +2) Bit 2: MFB display (Enabled: +4) Bit 3: AT progress display (Enabled: +8)	15	
℄ 76	● EV display setup (Operation display)	0: Not displayed 1: Set value of Internal event 1 is displayed 2: Set values of Internal event 1-2 are displayed 3: Set values of Internal event 1-3 are displayed	0	
℄ 77	● Timer remain time display setup (Operation display)	0: Not displayed 1: Internal event 1 is displayed 2: Internal event 1-2 is displayed 3: Internal event 1-3 is displayed	0	
℄ 78	● CT display setup (Operation display)	0: Not displayed 1: CT1 current value is displayed 2: CT1-2 current values are displayed	0	
℄ 79	● User level	0: Simple configuration 1: Standard configuration 2: High function configuration	1	
℄ 80	● Communication monitor display	0: Not used 1: Flashing while data is sending through RS-485 communication. 2: Flashing while data is receiving through RS-485 communication. 3: Logical OR of all DI statuses 4: Flashing in READY mode	0	
℄ 81	● MS display, Condition (top priority)	0: Normally OFF 1: Normally ON 2-9: Internal event 1-8 10-13: Undefined 14: MV1 15: MV2 16, 17: Undefined 18-21: DI1-4 22-25: Undefined 26-30: Internal contact 1-5 31-33: Undefined 34-37: Communication DI1-4 38: MANUAL 39: READY 40: RSP 41: AT 42: During ramp 43: Undefined 44: Alarm 45: PV alarm 46: Undefined 47: [mode] key pressing status 48: Event output 1 terminal status 49: Control output 1 terminal status	39	
℄ 82	● MS display, Status (top priority)	0: lit 1: Slow flashing 2: Flashing twice 3: Fast flashing 4: Left to right 5: Right to left 6: Reciprocating between left and right 7: Deviation OK 8: Deviation graph 9: MV graph 10: Heat-side MV graph 11: Cool-side MV graph 12: MFB graph 13: DI monitor 14: Internal contact monitor 15: Internal event monitor	1	
℄ 83	● MS display, Condition (secondary priority)	Same as MS display, Condition (top priority)	44	
℄ 84	● MS display, Status (secondary priority)	Same as MS display, Status (top priority)	6	
℄ 85	● MS display, Condition (third priority)	Same as MS display, Condition (top priority)	1	
℄ 86	● MS display, Status (third priority)	Same as MS display, Status (top priority)	9	
℄ 87	● MS display, Deviation range	0-9999 U	5	
℄ 88	● Special function	0-15 (This value becomes "0" when the power is turned ON.)	0	
℄ 89	● Zener barrier adjustment	The value can be changed with the adjustment. The numeric value cannot be directly input with the manual operation.	0.00	
℄ 90	● Number of CT1 turns	0: 800 turns 1-40: CT turns divided by 100	8	
℄ 91	● Number of CT1 power wire loops	0: 1 time 1-6: Number of times	1	
℄ 92	● Number of CT2 turns	0: 800 turns 1-40: CT turns divided by 100	8	
℄ 93	● Number of CT2 power wire loops	0: 1 time 1-6: Number of times	1	
℄ 97	● PV input failure (under range) type	0: -10%FS 1: -5 mV	0	

℄ ℄ ℄ [Event configuration bank]

Display	Item	Contents	Initial value	Setting value
℄ ℄ ℄ ℄ ℄ ℄	Internal event 1-5 Configuration 1 Operation type	Refer to event type (see page D-8)	0	
℄ ℄ ℄ ℄ ℄ ℄	Internal event 1-5 Configuration 2	The digits are determined to 1st, 2nd, 3rd, and 4th digit from the right end.		
	1st digit: Direct/Reverse	0: Direct 1: Reverse	0	
	2nd digit: Standby	0: None 1: Standby 2: Standby+Standby at SP change	0	
	3rd digit: EVENT state at READY	0: Continue 1: Forced OFF	0	
	4th digit: Undefined	0	0	
℄ ℄ ℄ ℄ ℄ ℄	Internal event 1-8 Configuration 3	The digits are determined to 1st, 2nd, 3rd, and 4th digit from the right end.		
	1st digit: Controller alarm OR	0: None 1: Alarm direct+OR operation 2: Alarm direct+AND operation 3: Alarm reverse+OR operation 4: Alarm reverse+AND operation	0	
	2nd digit: Special OFF setup	0: As usual 1: When the event set value (main setting) is 0, the event is "OFF".	0	
	3rd digit: Delay unit	0: 0.1 s 1: 1 s 2: 1 min	0	
	4th digit: Undefined	0	0	

℄ [DI assignment bank]

Display	Item	Contents	Initial value	Setting value
℄ 1-℄ 5, 1	Internal contact 1-3 Operation type	0: No function 1: LSP group selection (0/+1) 2: LSP group selection (0/+2) 3: LSP group selection (0/+4) 4: PID group selection (0/+1) 5: PID group selection (0/+2) 6: PID group selection (0/+4) 7: RUN/READY selection 8: AUTO/MANUAL selection 9: Invalid 10: AT Stop/Start 11: Invalid 12: Control action direct/reverse 13: SP Ramp enabled/disabled 14: PV Hold 15: PV Maximum value hold 16: PV Minimum value hold 17: Timer Stop/Start 18: Release all DO latches (Continue/Release) 19, 20: Invalid	0	
℄ 1-℄ 5, 2	● Internal contact 1-3 Input bit function	0: Not used (Default input) 1: Function 1 (A and B) or (C and D) 2: Function 2 (A or B) and (C or D) 3: Function 3 (A or B or C or D) 4: Function 4 (A and B and C and D)	0	
℄ 1-℄ 5, 3	● Internal contact 1-3 Input assign A	0: Normally opened 1: Normally closed 2-5: DI1-4 6-9: Undefined 10-14: Internal Event 1-5 15-17: Undefined 18-21: Communication DI1-4 22: MANUAL 23: READY 24: Invalid 25: AT running 26: During SP ramp 27: Undefined 28: Alarm occurs 29: PV alarm occurs 30: Undefined 31: mode key pressing status 32: Event output 1 status 33: Control output 1 status	2-5	
℄ 1-℄ 5, 4	● Internal contact 1-3 Input assign B		0	
℄ 1-℄ 5, 5	● Internal contact 1-3 Input assign C		0	
℄ 1-℄ 5, 6	● Internal contact 1-3 Input assign D		0	
℄ 1-℄ 5, 7	● Internal contact 1-3 Polarity A-D	The digits are determined to 1st, 2nd, 3rd and 4th digit from the right end.	0000	
	1st digit: Polarity A	0: Direct 1: Reverse	0	
	2nd digit: Polarity B		0	
	3rd digit: Polarity C		0	
	4th digit: Polarity D		0	
℄ 1-℄ 5, 8	● Internal contact 1-3 Polarity	0: Direct 1: Reverse	0	
℄ 1-℄ 5, 9	● Internal contact 1-3 Event channel def.	0: Every Internal Event 1-5: Internal Event No.	0	

• Items marked ● in the tables are displayed in standard and/or high function configuration.

• To change a user level, refer to **Changing the user level** in the lower right part of this page.

℄ ℄ [DO assignment bank]

Display	Item	Contents	Initial value	Setting value
℄ ℄ 1-℄ ℄ 2, 1	● Operation type (Control output 1-2, Event output 1-3)	0: Default output 1: MV1 2: MV2 3-6: Function 1-4	0	
℄ ℄ 1-℄ ℄ 2, 2	● Output assign A (Control output 1-2, Event output 1-3)	0: Normally opened 1: Normally closed 2-9: Internal Event 1-8 10-13: Undefined 14: MV1 15: MV2 16, 17: Undefined 18-21: DI1-4 22-25: Undefined 26-30: Internal Contact 1-5 31-33: Undefined 34-37: DI1-4 38: MANUAL	14, 15 or 2-4	
℄ ℄ 1-℄ ℄ 2, 3	● Output assign B (Control output 1-2, Event output 1-3)		0	
℄ ℄ 1-℄ ℄ 2, 4	● Output assign C (Control output 1-2, Event output 1-3)		0	
℄ ℄ 1-℄ ℄ 2, 5	● Output assign D (Control output 1-2, Event output 1-3)		0	
℄ ℄ 1-℄ ℄ 2, 6	● Control output 1-2, Event output 1-3 Polarity A to D	The digits are determined to 1st, 2nd, 3rd, and 4th digit from the right end.		
	1st digit: Polarity A	0: Direct 1: Reverse	0	
	2nd digit: Polarity B		0	
	3rd digit: Polarity C		0	
	4th digit: Polarity D		0	
℄ ℄ 1-℄ ℄ 2, 7	● Polarity (Control output 1-2, Event output 1-3)	0: Direct 1: Reverse	0	
℄ ℄ 1-℄ ℄ 2, 8	● Latch (Control output 1-2, Event output 1-3)	0: None 1: Latch (Latch at ON) 2: Latch (Latch at OFF except for initialization at power ON)	0	

℄ ℄ [User function bank]

Display	Item	Contents	Initial value	Setting value
℄ ℄ 1-℄ ℄ 8	● User function 1-8	—	—	

℄ ℄ [Lock bank]

Display	Item	Contents	Initial value	Setting value
℄ ℄	● Key lock	0: All settings are possible 1: Mode, event, operation display, SP, UF, lock, manual MV, [mode] key can be set 2: Operation display, SP, UF, lock, manual MV, [mode] key can be set 3: UF, lock, manual MV, [mode] key can be set	0	
℄ ℄ ℄	● Communication lock	0: read/write enabled 1: read/write disabled	0	
℄ ℄ ℄	● Loader lock	0: read/write enabled 1: read/write disabled	0	
℄ ℄ ℄ ℄	● Password display	0-15 (5: Password 1A to 2B display)	0	
℄ ℄ ℄ ℄	● Password 1A	0000-FFFF (Hexadecimal value)	0000	
℄ ℄ ℄ ℄	● Password 2A	0000-FFFF (Hexadecimal value)	0000	
℄ ℄ ℄ ℄	● Password 1B	0000-FFFF (Hexadecimal value)	0000	
℄ ℄ ℄ ℄	● Password 2B	0000-FFFF (Hexadecimal value)	0000	

℄ ℄ [Instrument information bank]

Display	Item	Contents	Initial value	Setting value
℄ ℄ 1	● ROM ID	1: Fixed	Disabled	
℄ ℄ 2	● ROM Version 1	XX.XX (2 digits after decimal point)	Disabled	
℄ ℄ 3	● ROM Version 2	XX.XX (2 digits after decimal point)	Disabled	
℄ ℄ 4	● Loader information		Disabled	
℄ ℄ 5	● EST information		Disabled	
℄ ℄ 6	● Manufacturing date code (year)	Subtract 2000 from the year. Example: "3" means the year 2003.	Disabled	
℄ ℄ 7	● Manufacturing date code (month, day)	Month+day divided by 100. Example: "12.01" means the 1st day of December.	Disabled	
℄ ℄ 8	● Serial No.		Disabled	

! Precaution for setup

- The type of auto tuning can be changed by changing the value of ℄ ℄ (AT type) in the extended tuning bank. Set it to match the control characteristics.
- Be sure the motor is adjusted: ℄ ℄ (motor auto adjust: start) in the setup bank.
- The result of AT control on a position proportioning model is that derivative time (D)=0. If satisfactory control cannot be obtained, set ℄ ℄ - ℄ (AT derivative time adjust, in the extended tuning bank) to 1.00.

Changing the user level

This controller's user level can be set to 1 of 3 types in setup ℄ 79. The number of possible displays and settings decreases according to the user level: high function > standard > simple.

All items are displayed when high function is selected.

1	<p>If necessary, press [mode] once to change to the operation display.</p> <p>Next, press and hold [para] for more than 2 seconds to get the parameter setup display. <i>node</i> flashes on the upper display.</p>	2	<p>Press [v] or [∧] repeatedly as needed to get <i>5tUP</i> flashing on the upper display.</p>
3	<p>Press [enter]. ℄ 79 is shown on the upper display. Press [<], [v] or [∧] to change to ℄ 79 (user level).</p>	4	<p>When [enter] is pressed, the lower display flashes. Press [v] or [∧] to change to the desired setting, and press [enter] to finalize your selection.</p> <p>0: Simple configuration 1: Standard configuration (initial value) 2: High function configuration</p>

PV input range table

[Thermocouple]			[RTD]		
C01 Set value	Sensor type	Range	C01 Set value	Sensor type	Range
1	K	-200 to +1200 °C	41	Pt100	-200.0 to +500.0 °C
2	K	0 to 1200 °C	42	JPt100	-200.0 to +500.0 °C
3	K	0.0 to 800.0 °C	43	Pt100	-200.0 to +200.0 °C
4	K	0.0 to 600.0 °C	44	JPt100	-200.0 to +200.0 °C
5	K	0.0 to 400.0 °C	45	Pt100	-100.0 to +300.0 °C
6	K	-200.0 to +400.0 °C	46	JPt100	-100.0 to +300.0 °C
7	K	-200.0 to +200.0 °C	47	Pt100	-100.0 to +200.0 °C
8	J	0 to 1200 °C	48	JPt100	-100.0 to +200.0 °C
9	J	0.0 to 800.0 °C	49	Pt100	-100.0 to +150.0 °C
10	J	0.0 to 600.0 °C	50	JPt100	-100.0 to +150.0 °C
11	J	-200.0 to +400.0 °C	51	Pt100	-50.0 to +200.0 °C
12	E	0.0 to 800.0 °C	52	JPt100	-50.0 to +200.0 °C
13	E	0.0 to 600.0 °C	53	Pt100	-50.0 to +100.0 °C
14	T	-200.0 to +400.0 °C	54	JPt100	-50.0 to +100.0 °C
15	R	0 to 1600 °C	55	Pt100	-60.0 to +40.0 °C
16	S	0 to 1600 °C	56	JPt100	-60.0 to +40.0 °C
17	B	0 to 1800 °C	57	Pt100	-40.0 to +60.0 °C
18	N	0 to 1300 °C	58	JPt100	-40.0 to +60.0 °C
19	PL II	0 to 1300 °C	59	Pt100	-10.00 to +60.00 °C
20	WR5-26	0 to 1400 °C	60	JPt100	-10.00 to +60.00 °C
21	WR5-26	0 to 2300 °C	61	Pt100	0.0 to 100.0 °C
22	Ni-Ni-Mo	0 to 1300 °C	62	JPt100	0.0 to 100.0 °C
23	PR40-20	0 to 1900 °C	63	Pt100	0.0 to 200.0 °C
24	DIN U	-200.0 to +400.0 °C	64	JPt100	0.0 to 200.0 °C
25	DIN L	-100.0 to +800.0 °C	65	Pt100	0.0 to 300.0 °C
26	Gold-iron Chromel	0.0 K to 360.0 K	66	JPt100	0.0 to 300.0 °C
			67	Pt100	0.0 to 500.0 °C
			68	JPt100	0.0 to 500.0 °C

[DC voltage/DC current]

C01 Set value	Sensor type	Range	C01 Set value	Sensor type	Range
81	0 to 10 mV	Scaling range is -1999 to +9999.	87	0 to 5 V	Scaling range is -1999 to +9999.
82	-0 to +10 mV		88	0 to 10 V	
83	0 to 100 mV		89	0 to 20 mA	
84	0 to 1 V		90	4 to 20 mA	
86	1 to 5 V				

□ : initial value

*1. The accuracy varies according to the range.
 The accuracy of the B thermocouple is $\pm 4.0\%$ FS for a range of 260 °C or less, $\pm 0.4\%$ FS for 260 to 800 °C and $\pm 0.2\%$ FS for 800 to 1800 °C.
 The PV values under 20 °C are not shown. The accuracy of the No.15 (sensor type R) or No.16 (sensor type S) is $\pm 0.2\%$ FS for a range of 100 °C or less, and $\pm 0.15\%$ FS for 100 to 1600 °C.
 The accuracy of the No.23 (sensor type PR40-20) is $\pm 2.5\%$ FS for 0 to 300 °C, and $\pm 1.5\%$ FS for 300 to 800 °C, $\pm 0.5\%$ FS for 800 to 1900 °C.
 The accuracy of the No.26 (sensor type gold iron chromel) is $\pm 1.5\%$ K.
 The accuracy of the No. 55 to 62 and 81 are $\pm 0.15\%$ FS for each range.
 The accuracy of the No.19 (sensor type PLII) in the range of 0 to 32 °F does not meet the indication accuracy.

*2. The indicated low limit for a B thermocouple is 20 °C. However, if ROM version 1 in the instrument information bank (I 002) is 2.04 or earlier, the low limit for display is -180 °C.

List of alarm code

Alarm code	Failure name	Cause	Corrective action
Input failure	R101 PV input failure (Over-range)	• Sensor burnout • Incorrect wiring	• Check the wiring. • Set the PV input type again.
	R102 PV input failure (Under-range)	• Incorrect PV input type setting	
	R103 CJ failure	• Terminal temperature is faulty (thermocouple).	• Check the ambient temperature.
		PV input failure	• Sensor burnout • Incorrect wiring (RTD)
	R105 RSP input failure (Over-range)*1	• Sensor burnout • Incorrect wiring	• Check the wiring. • Set the RSP input type again.
	R106 RSP input failure (Under-range)*1	• Incorrect RSP input type setting	
	R107 MFB input failure	• Burnout • Incorrect wiring	• Check the wiring. • Check the MFB input value.
Instrument failure	R110 PV input failure (RTD)	• Burnout • Incorrect wiring • Power for motor is shut-down.	• Check the wiring. • Adjust the motor again after checking the power for motor.
	R111 CT input failure (Over-range) (CT input 1 or 2, or both)	• A current exceeding the upper limit of the display range was measured. • The number of CT turns. • The number of CT power wire loops is incorrectly set. • Wiring is incorrect.	• Use a CT with the correct number of turns for the display range. • Reset the number of CT turns. • Reset the number of CT power wire loops. • Check the wiring.
R170 A/D conversion failure	• A/D converter is faulty.	• Replace the unit.	
Instrument failure	R195 Parameter failure	• Power is shut-down while the data is being set • Data is corrupted by noise.	• Restart the unit. • Set the data again (set data for R195/97 and adjustment data for R196/98).
	R196 Adjustment data failure		
	R197 Parameter failure*2	• Data is corrupted by noise.	• Replace the unit.
	R198 Adjustment data failure*2		
R199 ROM failure	• ROM (memory) is faulty.	• Reset the unit. • Replace the unit.	

*1. Displayed in RSP mode *2. RAM area

Handling Precautions

• If ROM version 1 of the instrument information bank (I 002) is prior to 2.04, CT input failure (R111) is not displayed.

Event type

Operation type	Set value	Direct action	Reverse action
		● shows that the ON/OFF is changed at this value. ○ shows that the ON/OFF is changed at a point that "IU" is added to this value.	
No event	0	Always OFF	Always OFF
PV high limit	1	 Main setting PV →	 Main setting PV →
PV low limit	2	 Main setting PV →	 Main setting PV →
PV high/low limit	3	 Main setting*1 Sub-setting*1 PV →	 Main setting*1 Sub-setting*1 PV →
Deviation high limit	4	 SP + Main setting PV →	 SP + Main setting PV →
Deviation low limit	5	 SP + Main setting PV →	 SP + Main setting PV →
Deviation high/low limit	6	 Main setting; Sub-setting; SP PV →	 Main setting; Sub-setting; SP PV →
Deviation high limit *2	7	 SP + Main setting PV →	 SP + Main setting PV →
Deviation low limit *2	8	 SP + Main setting PV →	 SP + Main setting PV →
Deviation high/low limit *2	9	 Main setting; Sub-setting; SP PV →	 Main setting; Sub-setting; SP PV →
Heater 1 burnout/Overcurrent	16	 Main setting*1 Sub-setting*1 CT1 at output ON. → OFF before measuring the CT1 current value	 Main setting*1 Sub-setting*1 CT1 at output ON. → OFF before measuring the CT1 current value
Heater 1 shortcircuit	17	 Main setting CT1 at output ON. → OFF before measuring the CT1 current value	 Main setting CT1 at output ON. → OFF before measuring the CT1 current value
Heater 2 burnout/Overcurrent	18	 Main setting*1 Sub-setting*1 CT2 at output ON. → OFF before measuring the CT2 current value	 Main setting*1 Sub-setting*1 CT2 at output ON. → OFF before measuring the CT2 current value
Heater 2 shortcircuit	19	 Main setting CT2 at output OFF. → OFF before measuring the CT2 current value	 Main setting CT2 at output OFF. → OFF before measuring the CT2 current value
Alarm (status)	23	ON if alarm occurs (alarm code R101-199). OFF in other cases.	OFF if alarm occurs (alarm code R101-199). ON in other cases.
High and low limits of MFB value	33	 Main setting*1 Sub-setting*1 MFB →	 Main setting*1 Sub-setting*1 MFB →

□ : initial value

*1. If the main setting is greater than the sub-setting, operations are performed with the main setting and sub-setting automatically swapped.

*2. Final SP reference.

Event types other than the above:

Operation type	Set value	Operation type	Set value	Operation type	Set value
SP high limit	10	Loop diagnosis 1	20	During AT (status)	27
SP low limit	11	Loop diagnosis 2	21	During SP ramp	28
SP high/low limit	12	Loop diagnosis 3	22	Control action (status)	29
MV high limit	13	READY (status)	24	ST setting standby (status)	30
MV low limit	14	MANUAL (status)	25	Estimated position control (status)	31
MV high/low limit	15	RSP (status)	26	Timer (status)	32

Handling Precautions

• If ROM version 1 of the instrument information bank (I 002) is prior to 2.04, "33" cannot be set as [Internal Event configuration 1 operation type].

Chapter 1. OVERVIEW

1 - 1 Overview

This unit is a compact controller having a mask of 48 X 96 mm or 96 X 96 mm and provides the following features:

- The depth is only 65 mm, providing excellent space-saving.
- The front panel is only 5 mm thick. This ensures excellent thin design.
- The display panel is large. This provides excellent visibility.
- [mode] key, [para] key, digit-shift keys, [display] key, and [enter] key are provided on the front panel. This ensures easy setup operation.
- Various input types are available, thermocouples (K, J, E, T, R, S, B, N, PLII, WRe5-26, Ni-NiMo, PR40-20, DIN U, DIN L, gold iron chromel), RTDs (Pt100, JPt100), current signals (4 to 20mA_{dc}, 0 to 20mA_{dc}), and voltage signals (0 to 10mV_{dc}, -10 to +10mV_{dc}, 0 to 1V_{dc}, 1 to 5V_{dc}, 0 to 5V_{dc}, and 0 to 10V_{dc}).
- The accuracy is $\pm 0.1\%$ FS and the sampling cycle time is 0.1 sec. This ensures high accuracy.
- For control output types, relay, voltage pulse for driving SSR, current output, and continuous voltage outputs are provided. Additionally, these control output types can be combined for control outputs 1 and 2.
- Three event output points or two event output points (independent contacts) are provided as standard functions.
- 2-point CT input, 4-point digital input, RSP input, and RS-485 can be combined as optional functions.
- Current output or continuous voltage output is provided as auxiliary output.
- The unit can be configured for the heat/cool control using the 2nd control output and/or event relay.
- The unit can be controlled by means of the ON/OFF control or fixed PID control method.
- In addition to the PID control, two algorithms, RationalLOOP and Just-FiTTER, are built-in, which ensures excellent controllability.
- The personal computer loader port is provided as standard function. The setup can be configured easily with use of the personal computer loader.
- Use of optional the SLP-C35 Smart Loader Package makes it possible to easily perform the read/write operation of the parameters.
In addition to the table format setup, the operation and control status can be monitored using the trend display. This unit can be operated without use of program on the host unit.
- The unit conforms to the IEC directive and the CE marking is affixed on the unit.
(Standards compliance: EN61010-1 and EN61326-1)

■ Model selection table

The following shows the model selection table of this unit:

Basic model No.	Mounting	Control output	PV input	Power supply	Option		Additional treatment		Specifications	Notes	
					1	2	1	2			
C35									SDC35 Mask size 48 mm X 96 mm		
C36									SDC36 Mask size 96 mm X 96 mm		
	T								Panel mounting type		
	(Note 3)								Control output 1	Control output 2	
		R0							Relay output NO	None (relay output for control output 1: N.C.)	
		R1							Motor drive relay output OPEN side	Motor drive relay output CLOSE side	With MFB
		V0							Voltage pulse output	None (for SSR drive)	
		VC							Voltage pulse output	Current output (for SSR drive)	
		VD							Voltage pulse output	Continuous voltage output (for SSR drive)	
		VV							Voltage pulse output (for SSR drive)	Voltage pulse output (for SSR drive)	
		C0							Current output	None	
		CC							Current output	Current output	
		CD							Current output	Continuous voltage output	
		D0							Continuous voltage output	None	
		DD							Continuous voltage output	Continuous voltage output	
		U								Universal	
			A							AC Model (100 to 240Vac)	
		D							DC Model (24Vac/24Vdc)		
						1			Event relay outputs 3 points		
						2			Event relay output: 3 points, auxiliary output (current output)		
						3			Event relay output: 3 points, auxiliary output (voltage output)		
		(Note 3)				4			Event relay output: 2 points (independent contact)		
		(Note 3)				5			Event relay output: 2 points (independent contact), auxiliary output (current output)		
		(Note 3)				6			Event relay output: 2 points (independent contact), auxiliary output (voltage output)		
						0			None		
		(Notes 1, 2)				1			Current transformer input: 2 points, Digital input: 4 points		
		(Notes 1, 2)				2			Current transformer input: 2 points, Digital input: 4 points, RS-485 communication		
		(Notes 1, 2)				3			Current transformer input: 2 points, Digital input: 2 points, RSP input		
		(Notes 1, 2)				4			Current transformer input: 2 points, Digital input: 2 points, RSP input, RS-485 communication		
		(Note 4)				0			No additional treatment		
						D			Inspection Certificate provided		
						Y			Complying with the traceability certification		
						0			None		
						A			UL-marked product		

Note 1. Current transformer sold separately.

Note 2. When the control output is R1, the current transformer input is not applied. MFB input is applied instead.

Note 3. Can not be selected for the DC Model.

Note 4. Additionally, tropicalization and anti-sulfidation treatments can be ordered. However, there are some specifications restrictions. For details, contact the azbil Group.

■ Accessories and optional parts

Name	Model No.
Mounting bracket	81409654-001 (Accessory)
Current transformer	QN206A* (800 turns, 5.8mm hole dia.)
	QN212A* (800 turns, 12mm hole dia.)
Hard cover	81446915-001 (for C35)
	81446916-001 (for C36)
Soft cover	81441121-001 (for C35)
	81441122-001 (for C36)
Terminal cover	81446912-001 (for C35)
	81446913-001 (for C36)

* Not UL-certified.

1 - 2 Part Names and Functions

■ Main body and console

● C35

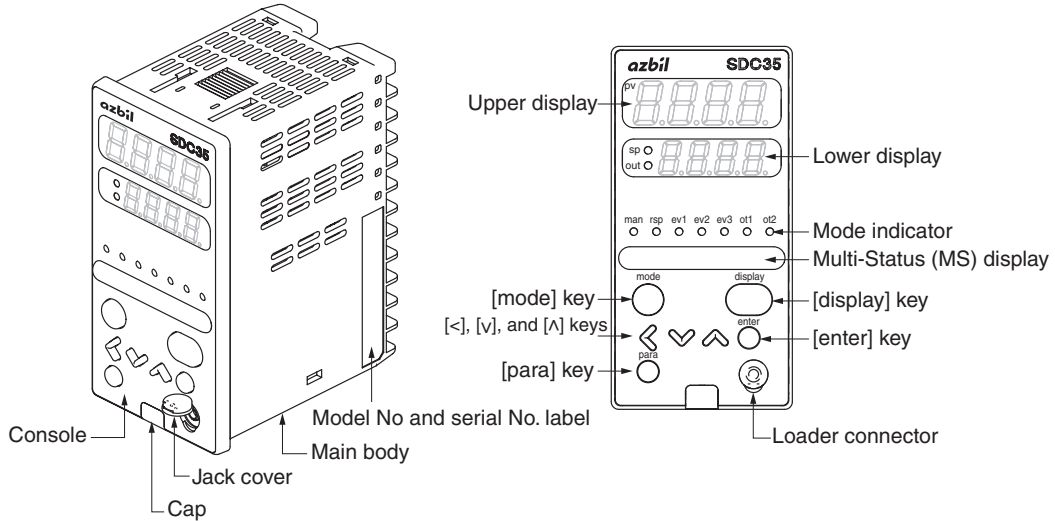

● C36

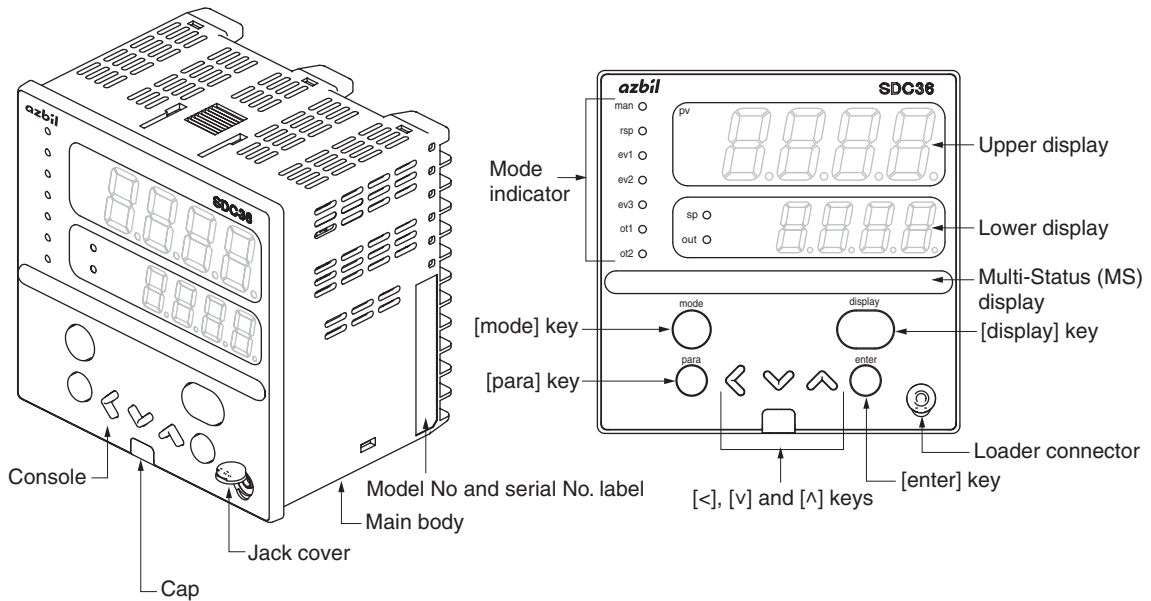

- Main body: Contains the electronic circuit for I/O signals of measuring instruments, CPU, and memory.
- Console: Contains the display panel showing numeric value and status, and operation keys.
- Cap: Covers the slit, which is used to pull out the console from the main body.

❗ Handling Precautions

The user must not touch the cap. This cap is used only by Azbil Corporation's engineers when repairing this controller. If the cap is pulled forcibly, this may be broken.

- Detailed description of console

- [mode] key

- When this key is kept pressed for 1 sec. or longer in the operation display mode, any of the following operations, which have been set previously, can be performed:

- AUTO/MANUAL mode selection
 - RUN/READY mode selection
 - Auto Tuning (AT) start/stop selection
 - Local SP (LSP) group selection
 - Release all Digital Output (DO) latches
 - LSP/RSP mode selection
 - ON/OFF selection of communication Digital Input (DI) 1

- When pressing the [mode] key in the setup display mode, the display is changed to the operation display.

- [display] key

- This key is used to change the display item in the operation display mode.

- When pressing this key in the bank selection, bank setup, or user function setup display mode, the display is changed to the operation display.

- [para] key

- When this key is kept pressed for 2s or longer in the operation display mode, the display is then changed to the bank selection display.

- [<], [v], [^] keys

- These keys are used to increase or decrease the numeric value, or to shift the digit.

- The [v] and [^] keys are used to change the bank in the bank selection display mode. In the bank setup display mode, these keys are used to change the display item.

- [enter] key

- This key is used to start changing setup values. Additionally, the key is also used to set setup values currently being changed.

- When pressing this key in the bank selection display mode, the bank is set and the display is changed to the bank setup display.

- Upper display

- This display shows the PV value or the name of each display item (display value or set value). If an alarm occurs in the operation display mode, the normal display and alarm code are displayed alternately.

- The decimal point at the right end digit shows auto tuning (AT) status. The decimal point flashes twice repeatedly during execution of AT.

- Lower display

- This display shows the SP value, or the display value or set value of each display item. The decimal point at the right end digit shows the RUN/READY mode or communication status.

Mode indicators

- [man]: AUTO/MANUAL mode indicator. Lights in MANUAL mode.
- [rsp]: LSP/RSP mode indicator. Lights in RSP mode.
- [ev1], [ev2], [ev3]: Event output 1 to 3 indicator. Lights when event relays are ON.
- [ot1], [ot2]: Control output 1 and 2 indicator. Lights when the control output is ON. The indicators are always lit when the current output or continuous voltage output is used.

Multi-Status (MS) display

By combining the lighting conditions with the lighting status, three groups can be set for priority display.

For lighting conditions, the internal event ON status, DI ON status, and READY mode are provided.

For lighting status, flashing, reciprocating between left and right, and MV graph are provided.

Jack cover: This jack cover protects the loader connector. When connecting the loader, pull this cover upward by finger.

Loader connector: This connector is used for connecting to a personal computer using the dedicated cable supplied with the Smart Loader Package.

! Handling Precautions

- To select the LSP group using the [mode] key, it is necessary to set a value of "2" or more in [LSP system group].
- To show the RUN/READY mode and communication status using the decimal point at the right end digit on the lower display, select "High function configuration" and make the [LED monitor] settings.
- Do not operate the key with a sharp object (such as tip of mechanical pencil or needle). Doing so might cause the unit to malfunction.
- If the jack cover is pulled forcibly, it may be broken. Never attempt to pull this cover forcibly.

■ Rear panel

- C35

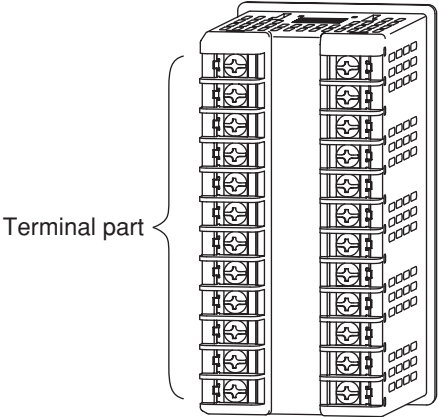

- C36

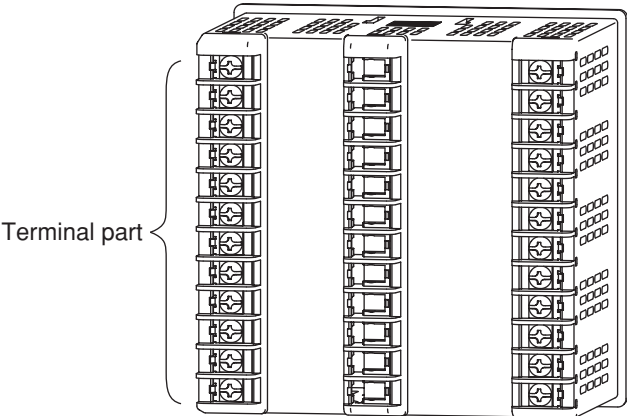

Terminal part: The power supply, input, and output are connected to the terminals. The M3 screw is used. When connecting to the terminal, always use a correct crimp type terminal lug suitable for the M3 screw. The tightening torque of the terminal screw is 0.4 to 0.6N·m or less.

Chapter 2. OUTLINE OF FUNCTIONS

2 - 1 Input/Output Configuration

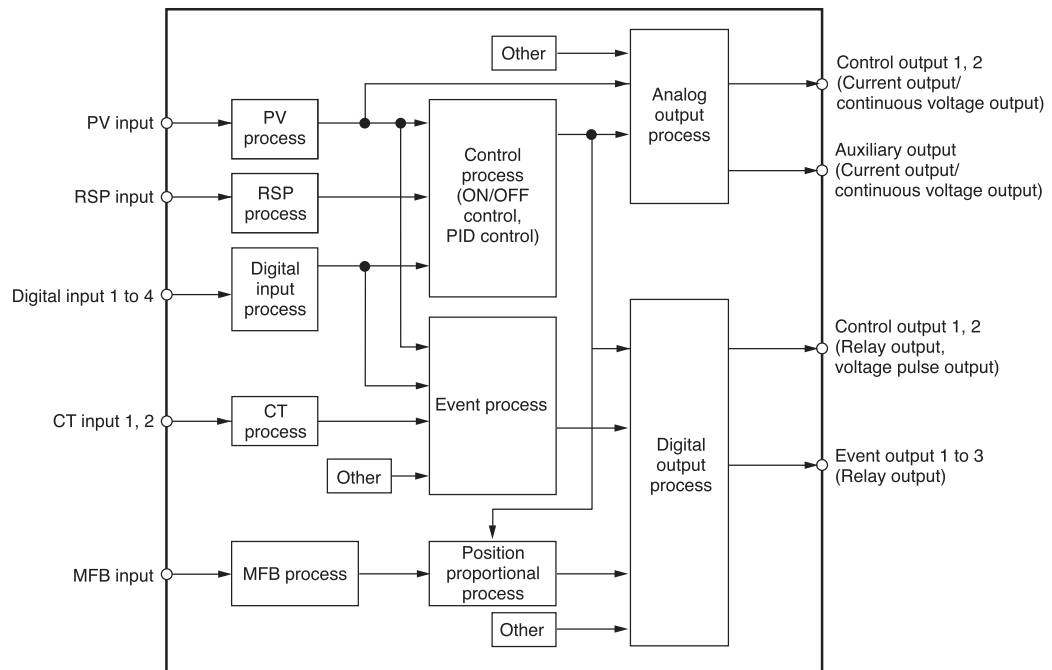

- **PV input**

Sensor or range is selected for the PV input. When the PV input is the DC voltage or DC current, the PV scaling high limit/low limit can be set.

- **Control output**

When the control output type of the model is "R: Relay" or "V: Voltage pulse", the control output becomes the ON-OFF control output or time proportional output. When the time proportional output is used, the time proportioning cycle time can be set. When the control output type of the model is "C: Current" or "D: Continuous voltage", the control output becomes the continuous output (analog output). When the model has two control outputs, the heat/cool control can be used only with "Basic configuration".

When the control output type of the model is "R1: Position proportional output + MFB", the position proportional control can be performed using two relays.

- **Event output**

When the model provides the event, the alarm or control mode set in [Event type] can be output as digital output (DO).

- **Digital input (DI)**

When the model provides the DI, the function set with the DI assignments can be selected.

- **Current transformer (CT) input**

When the model provides the CT input, the heater burnout alarm can be output from the event output.

- **Remote SP (RSP) input**

When the model provides the RSP input, the range of the RSP input can be selected and the RSP input range scaling low limit/high limit can be set.

- **Motor Feed Back (MFB) input**

When the model provides the position proportional output, the feedback data of the modutrol motor opening can be input.

2 - 2 Key Operation

Various displays or settings can be called up on the console through key operation.

The following describes the general flow of key operation:

The display and setting data are arranged as shown in the following tree-structure:

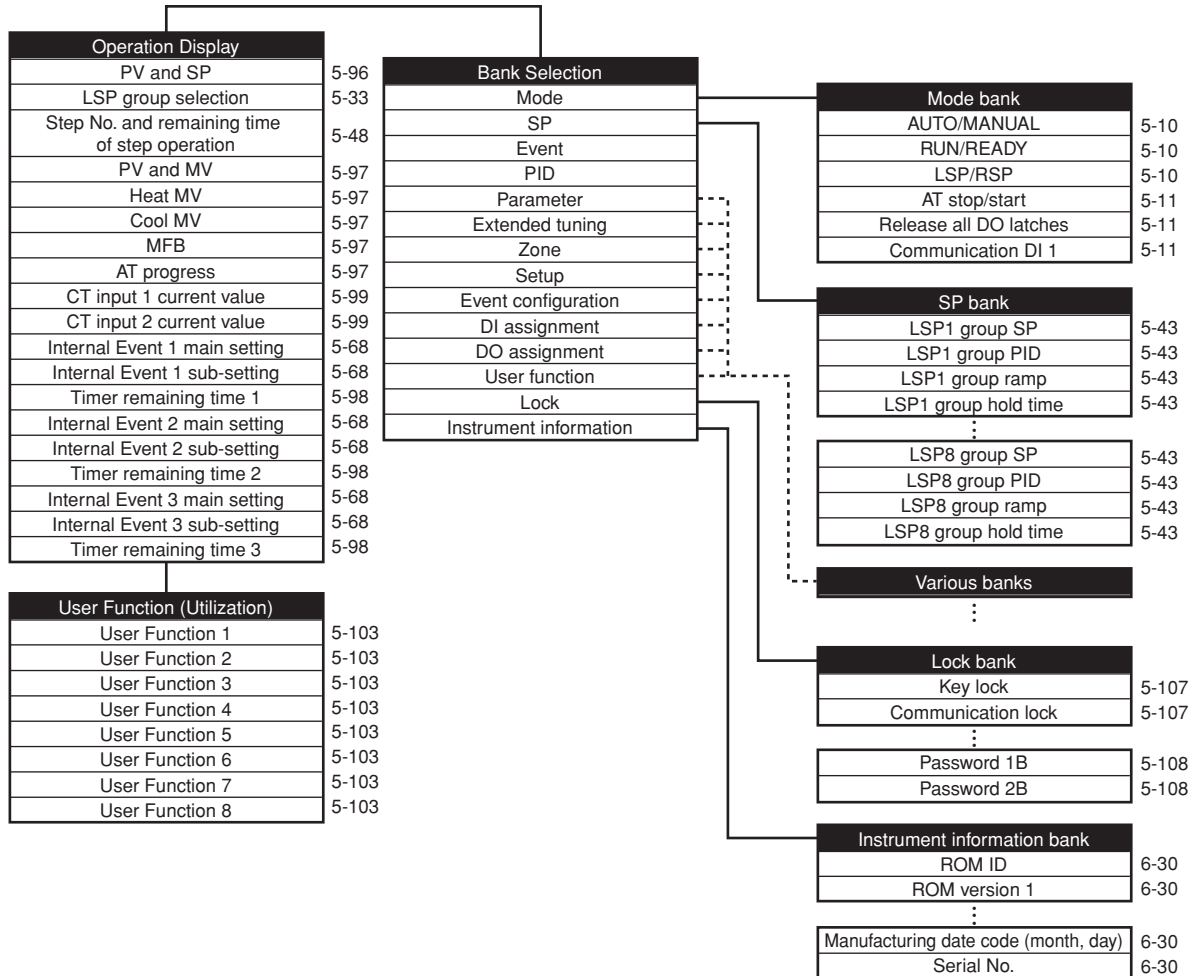

(Note) The figures shown on the right of the display and setting columns in the tree-structure indicate the relevant pages.

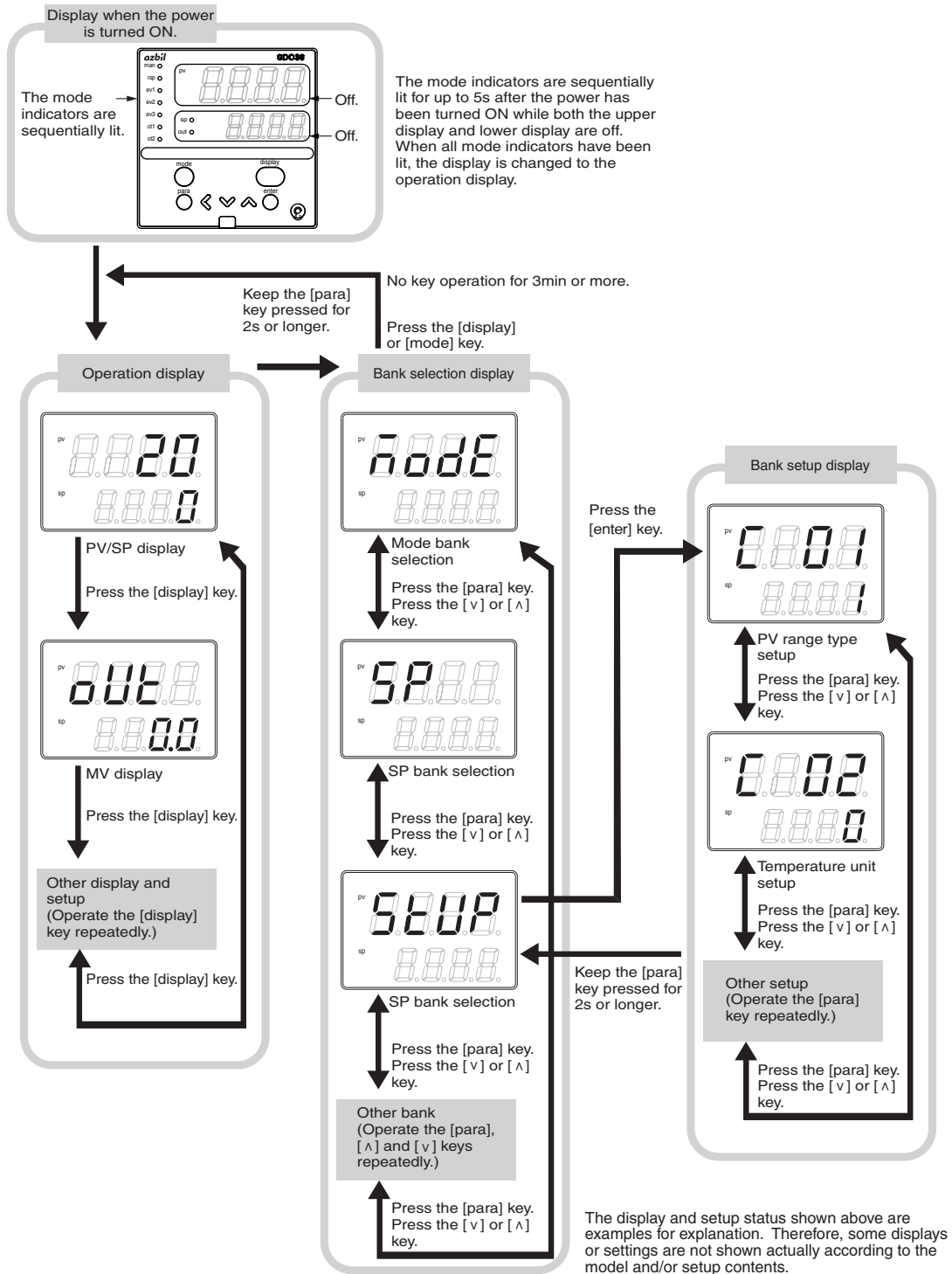

! Handling Precautions

- For details about display and setup contents of the operation display, parameter setting display, and setup setting display,
 - ➔ 6-1 List of Operation Displays (on page 6-1),
 - 6-2 List of Parameter Setting Displays (on page 6-3) and
 - 6-3 List of Setup Setting Displays (on page 6-12).
- In the lists shown above, the banks to which each setting item is belonged are described.

- When pressing the [\leftarrow] key with the [para] key kept pressed instead of pressing of the [para] key on the setting display, various displays and settings can be operated in the reverse order. However, the operation that both the [para] key and [\leftarrow] key are kept pressed for 2s or longer, is invalid.
- When pressing the [\leftarrow] key with the [display] key kept pressed instead of pressing the [display] key in the operation display mode, various displays and setting displays can be operated in the reverse order.

■ Data setting procedures

Two types of data setting procedures are provided, standard type and special type. A desired type can be selected using the setup bank [C71: Key operation mode/type].

Standard type: The [enter] key is used to start changing the setup value and to set the value currently being changed.

Special type: The [\leftarrow], [\vee], or [\wedge] key is used to start changing the setup value. To set the value currently being changed, wait for 2s without pressing of any key. (However, only the standard type operation can be performed in the bank setup display mode.)

Display mode \ Type setup	Setup bank C71 = 0	Setup bank C71 = 1
Operation display	Standard type	Special type
Bank setup display	Standard type	Standard type
User function setup display	Standard type	Special type

● Standard type

(1) Operate the [display], [para], [\leftarrow], [\vee], or [\wedge] key to display desired data to be set.

(How to display the data is explained in "General flow of key operation" described previously.)

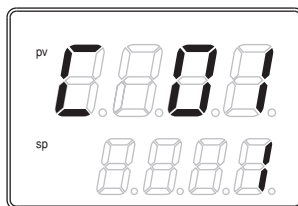

(This Figure shows the display when setting the PV range type of the setup setting [C01].)

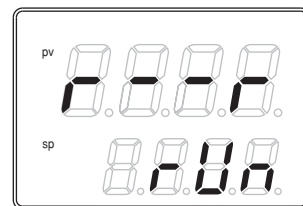

(This Figure shows the display when setting the RUN/Ready selection in the parameter setting [r--r].)



(2) Press the [enter] key.

>> When the lower display shows a numeric value, the 1st digit starts flashing. Additionally, when the lower display shows a character string, the entire character string starts flashing.

When a numeric value is displayed, the value can be increased or decreased or the flashing digit can be moved using the [\leftarrow], [\vee], or [\wedge] key.

When a character string is displayed, the entire flashing character string can be changed using the [\vee], or [\wedge] key.

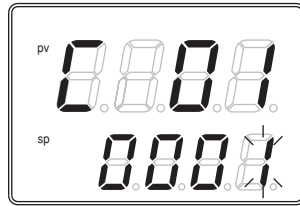

(This Figure shows the display when the 1st digit of "0001" is flashing.)

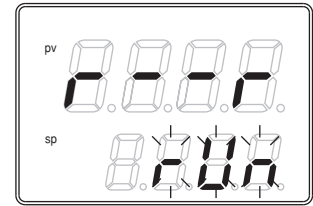

(This Figure shows the display when the entire character string "rUn" is flashing.)



(3) Press the [enter] key.

>> The flashing display is stopped, and then the data you have changed is set.

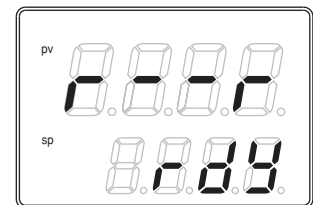
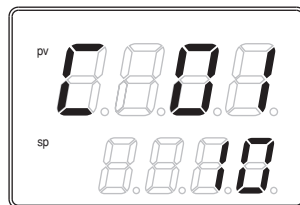

● Special type

(1) Operate the [display] or [para] key to display desired data to be set.

(How to display the data is explained in "General flow of key operation" described previously.)

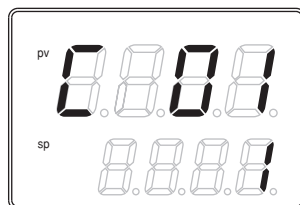

(This Figure shows the display when setting the PV range type of the setup setting [C01].)

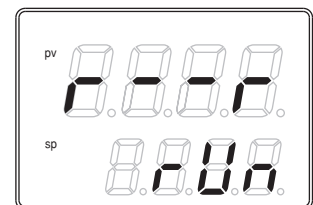

(This Figure shows the display when setting the RUN/Ready selection in the parameter setting [r--r].)



(2) Press any of the [<], [v], and [^] keys.

>> When the lower display shows a numeric value, the 1st digit starts flashing. Additionally, when the lower display shows a character string, the entire character string starts flashing.

When a numeric value is displayed, the value can be increased or decreased or the flashing digit can be moved using the [<], [v], or [^] key.

When a character string is displayed, the entire flashing character string can be changed using the [v], or [^] key.

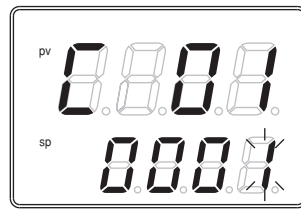

(This Figure shows the display when the 1st digit of "0001" is flashing.)

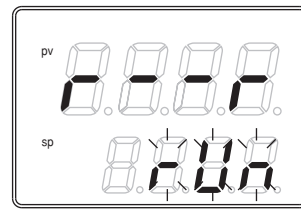

(This Figure shows the display when the entire character string "rUn" is flashing.)



(3) Release the key and wait for a while.

>> After 2s have elapsed, the flashing display is stopped, and then the data you have changed is set.

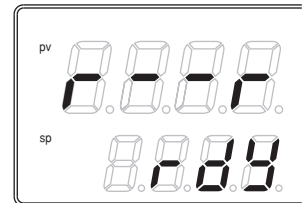
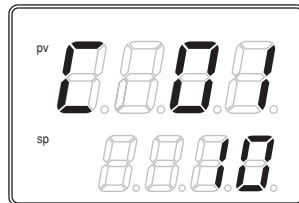

! Handling Precautions

- If the data does not start flashing even though the [enter] key is pressed (for a standard type) or the [<], [v], or [^] key is pressed (for a special type), this data cannot be changed.
For example, when the RUN/READY is assigned in the DI Assignment, RUN/READY cannot be selected using the key on the front panel.
- If the character string cannot be changed using the [v] key while the entire character string is flashing, press the [^] key.
On the contrary, if the character string cannot be changed using the [^] key, press the [v] key.
- When pressing the [para] key while the display is flashing on the bank setup display or user function setup display, the next data is displayed without changing of the data. Additionally, when pressing the [display] or [mode] key while the display is flashing, the display returns to the operation display without changing of the data.
- When pressing the [display] key while the display is flashing on the operation display, the next data is displayed without changing of the data.
- The MV (manipulated variable) display in the MANUAL mode continues the flashing status even after pressing of the key has been stopped. At this time, the flashing value is output as MV.

■ [mode] key operating procedures

When the [mode] key is kept pressed for 1 sec. or longer on the operation display, the selection operation, which has been set using the [mode] key function (C72) of the setup setting, can be performed.

The Figure on the right shows an example that the [mode] key is pressed in the RUN/READY selection (C72 = 2) setting.

(1) If the current mode is the READY mode when the PV/SP is shown on the operation display, the character string "rUn" on the lower display starts flashing.

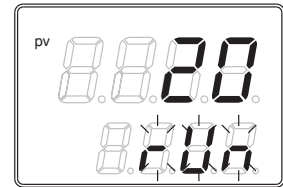

(2) When the [mode] key is kept pressed for 1 sec. or longer, the READY mode is changed to the RUN mode and the flashing of the character string "rUn" is stopped.

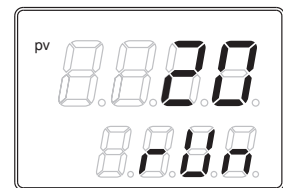

(3) When pressing of the [mode] key is stopped, the display is returned to the original display.



⚠ Handling Precautions

- If the MODE key function of the setup setting is set disabled (C72 = 0) or if the set selection operation is invalid, the selection operation cannot be performed using the [mode] key.
- When pressing the [mode] key on the parameter setting display or setup setting display instead of the operation display, the display is returned to the operation display. However, even though the [mode] key is kept pressed continually, the selection operation cannot be performed. In this case, stop pressing the key once, and then press the [mode] key.

■ User level

The user level of this unit can be selected from three levels, "Basic configuration", "Standard configuration", and "High function configuration" using [C79: User level] of the setup setting.

➔ Chapter 6, LIST OF DISPLAYS AND SETTING DATA.

⚠ Handling Precautions

Even though the user level is changed, the functions other than setting display cannot be changed. The user level is set to "Standard configuration" or "High function configuration" and more advanced functions are set. After that, when the setup is returned to "Basic configuration", this function setup cannot be displayed, but the function itself is operated.

2 - 3 Operation Modes

The following shows the transition of operation modes:

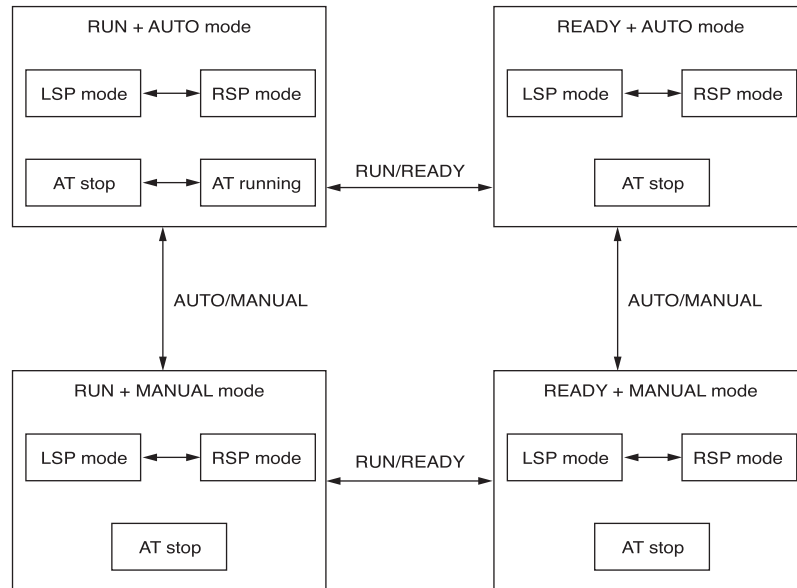

RUN: Control status

READY: Control stop status

AUTO: Automatic operation (This unit automatically determines the MV values.)

MANUAL: Manual operation (The MV values are operated manually.)

LSP: Local SP (The control is performed using the SP stored in the measuring instrument.)

RSP: Remote SP (The analog input from the external device is used as SP.)

AT: Auto tuning (The PID constants are set automatically using the limit cycle.)

Chapter 3. INSTALLATION

⚠ CAUTION



Use the SDC35/36 within the operating ranges recommended in the specifications (temperature, humidity, voltage, vibration, shock, mounting direction, atmosphere, etc.).

Failure to do so might cause fire or faulty operation.



Do not block ventilation holes.

Doing so might cause fire or faulty operation.

■ Installation locations

Choose an installation location with the following characteristics:

- With the exception of supply power and relay contact output, the I/O common mode voltage to ground must be 30 VRMS max., 42.4 V peak max., 60 Vdc max.
- Not subject to high or low temperature/humidity.
- Free from silicone gas and other corrosive gases such as sulfide gas.
- Little dust or soot.
- Appropriate protection from direct sunlight, wind or rain.
- Little mechanical vibration or shock.
- Not under high voltage lines or near welding machines or other sources of electrical noise.
- At least 15m away from high voltage ignition device for a boiler, etc.
- Not subject to strong electromagnetic fields.
- No flammable liquids or fumes.
- Indoors.

■ External dimensions

● C35

Unit: mm

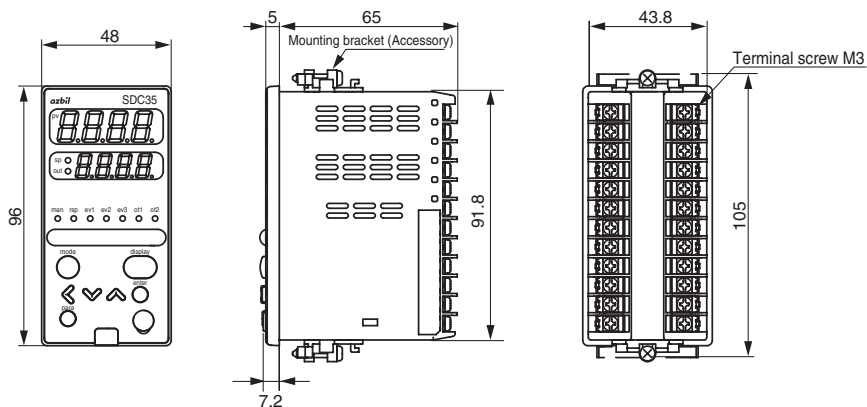

● C36

Unit: mm

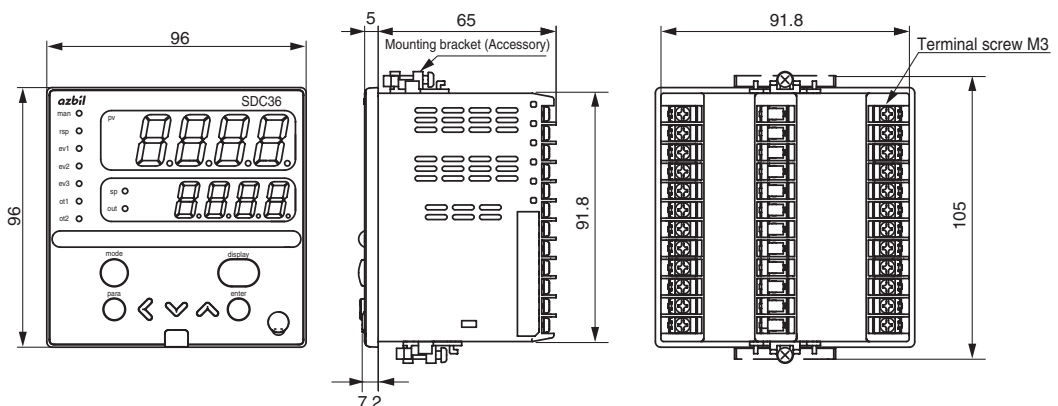

■ Panel cutout dimensions

Make the mounting holes according to the panel hole marking dimensions.

● C35

Unit: mm

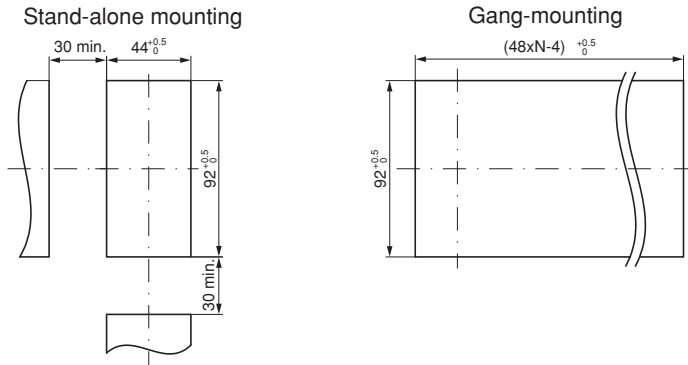

● C36

Unit: mm

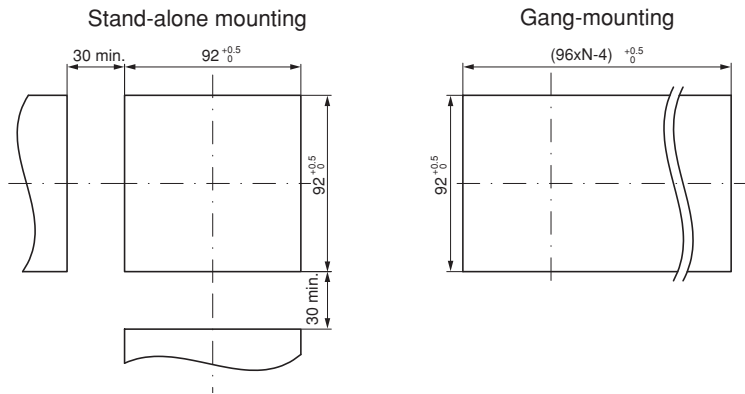

⚠ Handling Precautions

- When three or more units are gang-mounted horizontally, the maximum allowable ambient temperature is 40°C.
- Provide a space of at least 30mm or more above and below the controller.

■ Mounting procedures

- The mounting must be horizontal within 10 degrees tilted on the back side lowering or within 10 degrees tilted on the back side rising.
- The mounting panel should be used with a thickness of less than 9 mm of firm board.

● Ordinal mounting

Tools:

Phillips-head screwdriver

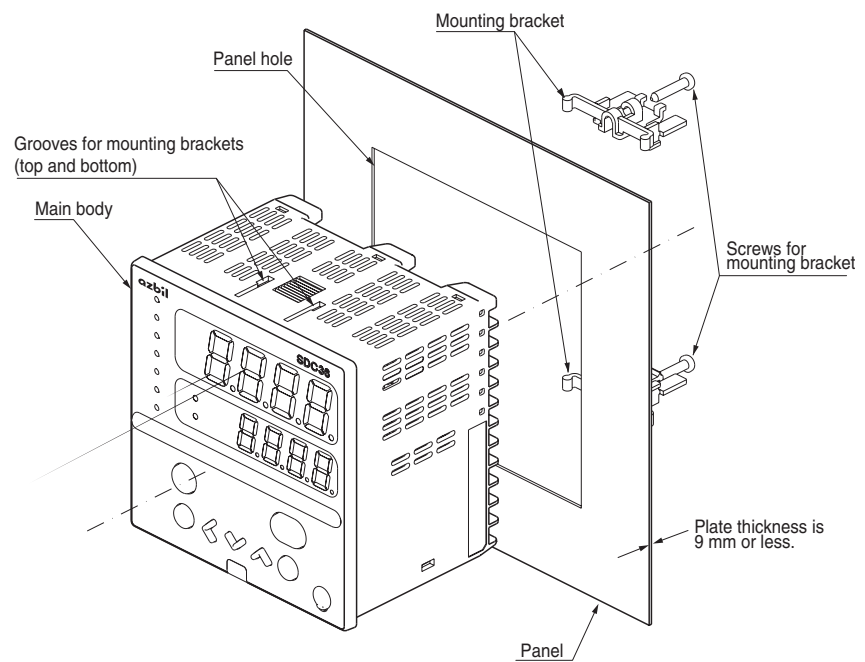

- (1) Insert this unit from the front of the panel.
- (2) Fit the mounting bracket from the back of the panel.
- (3) Push the mounting bracket against the panel until the hook of the mounting bracket is firmly engaged with the groove of the main body.
- (4) Tighten the upper and lower screws of the mounting bracket.

⚠ Handling Precautions

- To fasten this controller onto the panel, tighten a mounting bracket screws, and turn one more turn when there is no play between the bracket and panel. Excessive tightening of the screws may deform the controller case.

● Using a hard cover

For panel mounting type, it is possible to attach the hard cover to the front console. Use of hard cover makes it possible to prevent the settings from being changed due to accidental operation or to operate the unit in poor installation environment. The display can be seen with the cover kept closed. Raise the cover to operate the key.

Items to be prepared:

- Hard cover (for SDC35) Part No. 81446915-001 (Optional unit)
- Hard cover (for SDC36) Part No. 81446916-001 (Optional unit)

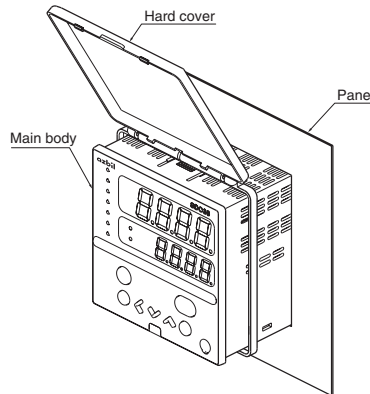

- (1) As shown in the Figure, mount the hard cover.
- (2) Insert this unit from the front of the panel.
- (3) Fit the mounting bracket from the back of the panel.
- (4) Push the mounting bracket against the panel until the hook of the mounting bracket is firmly engaged with the groove of the main body.
- (5) Tighten the upper and lower screws of the mounting bracket.

! Handling Precautions

- To fasten this controller onto the panel, tighten a mounting bracket screws, and turn one more turn when there is no play between the bracket and panel. Excessively tightening the screws may deform the controller case.

● How to use the hard cover

When operating the unit with the hard cover, flip the lower end of the cover upward. At this time, the cover is so designed that it can be kept open without holding the cover by hand.

After the cover has been flipped upward, slide it to the right as shown in the Figure. The hard cover is then locked/latched at an angle of approximately 30° to the panel surface. In this status, the key operation and loader connection can be made.

To return the cover to the previous position, slide the cover to the left and when released it flips downward and covers the unit.

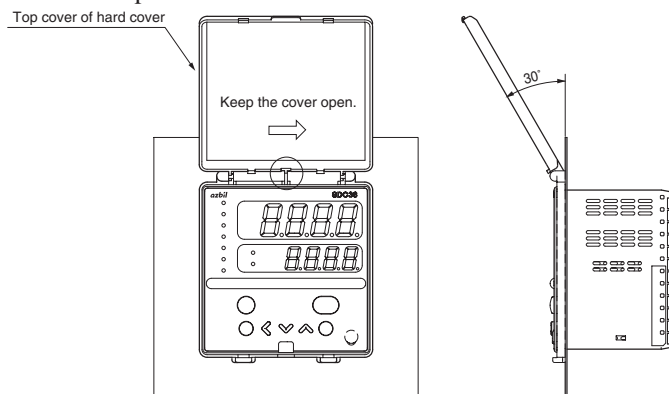

● Using a soft cover

For the panel mounting type, it is possible to attach the soft cover to the front console.

The key can be operated with the soft cover attached.

Attaching the soft cover to the front console provides the protection (IP66) similar to the waterproof mounting using the gasket.

Items to be prepared:

Soft cover (for SDC35) Part No. 81441121-001 (Optional unit)

(for SDC36) Part No. 81441122-001 (Optional unit)

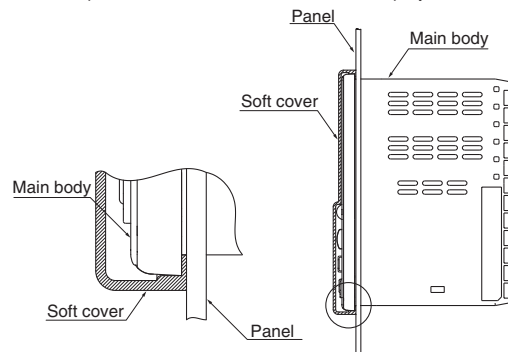

The gasket supplied with the main body is not used.

- (1) Attach the soft cover so that it covers the console of the main body.
- (2) Insert the unit with the soft cover attached from the front of the panel.
- (3) Fit the mounting bracket from the back of the panel.
- (4) Push the mounting bracket against the panel until the hook of the mounting bracket is firmly engaged with the groove of the main body.
- (5) Tighten the upper and lower screws of the mounting bracket.

⚠ Handling Precautions

- To fasten this controller onto the panel, tighten a mounting bracket screws, and turn one more half turn when there is no play between the bracket and panel. Excessively tightening the screws may deform the controller case.
- If gang-mounted, dustproof and waterproof protection may not be maintained.

Chapter 4. WIRING

4 - 1 Wiring

WARNING



Before removing, mounting, or wiring the SDC35/36, be sure to turn off the power to the SDC35/36 and all connected devices. Failure to do so might cause electric shock.



Do not touch electrically charged parts such as the power terminals. Doing so might cause electric shock.

CAUTION



Wire the SDC35/36 properly according to predetermined standards. Also wire the SDC35/36 using specified power leads according to recognized installation methods.

Failure to do so might cause electric shock, fire or faulty operation.



Do not allow lead clippings, chips or water to enter the controller case. Doing so might cause fire or faulty operation.



Firmly tighten the terminal screws with the specified torque as listed in the specifications.

Insufficient tightening of terminal screws might cause electric shock or fire.



Do not use unused/spare terminals on the SDC35/36 as relay terminals. Doing so might cause electric shock, fire, or faulty operation.



We recommend attaching the terminal cover (sold separately) after wiring the SDC35/36.

Failure to do so might cause electric shock, fire, or faulty operation.



Use the relays within the recommended life.

Failure to do so might cause fire or faulty operation.



If there is a risk of a power surge caused by lightning, use a surge absorber (surge protector) to prevent fire or device failure.^a



Do not make incorrect connections. If the cables are connected incorrectly, this might cause the unit to malfunction.



The controller requires 6 seconds to stabilize after power ON. Great care should be taken when the relay output from the controller is used as interlock signals.



The part between the control output 1 and control output 2 is not isolated. When necessary, use an appropriate isolator.



Do not connect multiple loader cables to multiple units from one personal computer. The current coming from other circuits might cause the PV value indication error to occur.





Do not connect any terminating resistor in the communication path when performing the RS-485 wiring. Doing so might cause the communication to fail.



Always mount a switch for shut-down of the main power of this unit in an area easily accessible to the operator when performing electric wiring of this unit. Additionally, connect a slow-action type (T) fuse having a rated current of 0.5A and rated voltage of 250V to the wiring for the instrument power supply of the AC power supply model. (IEC127)

■ Terminal assignment label symbols

The following table shows the meanings of the symbols used for the terminal assignment label attached to the side panel of this unit:

Symbol	Contents
~	AC
---	DC power supply
	Caution, Electric shock hazard
	Caution

■ Wiring precautions

- Before starting the wiring work, carefully check the label on the side panel of this unit to understand the model No. and terminal No. to carry out the wiring properly.
- Use an appropriate crimp type terminal lug suitable for the M3 screw to connect the terminals. The tightening torque of the terminal screw must be 0.4 to 0.6N·m or less.
- Pay special attention so that no crimp type terminal lugs are in touch with adjacent terminals.
- To connect 2 (max.) crimp terminals to the same terminal screw, bend the crimp terminals beforehand.
- Keep the input/output signal cables 50cm or more away from the drive power cable and/or power cable. Additionally, do not lay the input/output signal cables and the drive power cable and/or power cable together in the same conduit or duct.
- When connecting this unit and other measuring instrument in parallel, carefully check the conditions necessary for other instrument before starting the instrumentation.
- The digital input is so designed that it is potential free input. A contact for micro current must be used.
- The heater current carrying conductor must be routed through the current transformer. Additionally, carefully check that the heater current does not exceed the allowable current limit stated in the specification. If the heater current exceeds the allowable current limit, this might cause damage to this unit.
- The input of the current transformer cannot be used for the phase angle control.
- An optional terminal cover is available to prevent electric shock. (Model No.: 81446912-001 for C35 or 81446913-001 for C36)

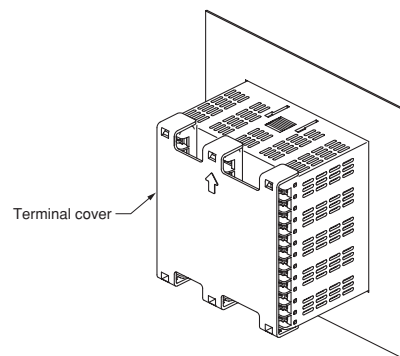

- The part between the control output 1 and control output 2 is not isolated. When necessary, use an appropriate isolator.

IMPORTANT Terminating resistor

- Do not connect any terminating resistor in the RS-485 communication path. Doing so might cause the communication failure.

- If the motor connected to the motor drive relay output is used with a 100/200 Vac power supply, the use of an external auxiliary relay is recommended. If an auxiliary relay is not used, thoroughly check the operating conditions (operating voltage of the motor, inrush current, frequency of switching, etc.) before use.
- Do not run the motor drive terminals (13), (14), and (15), and MFB input terminals (7), (8), and (9) in the same duct. Additionally, do not use 6-core cables for the wiring work. Doing so might cause the unit to malfunction due to noise at start-up of the motor.
- Make sure that devices and equipment connected to this device have reinforced insulation suitable for the maximum operating voltage of this device's power supply and input/output ports.
- This unit has been designed to start functioning after an initial stabilization period of 5 seconds after power ON, in order to ensure stable operation. After that, the unit then enters the operation mode. However, to satisfy the specified accuracy, it is necessary to warm up the unit for at least 30 min.

● Wiring of C35/36

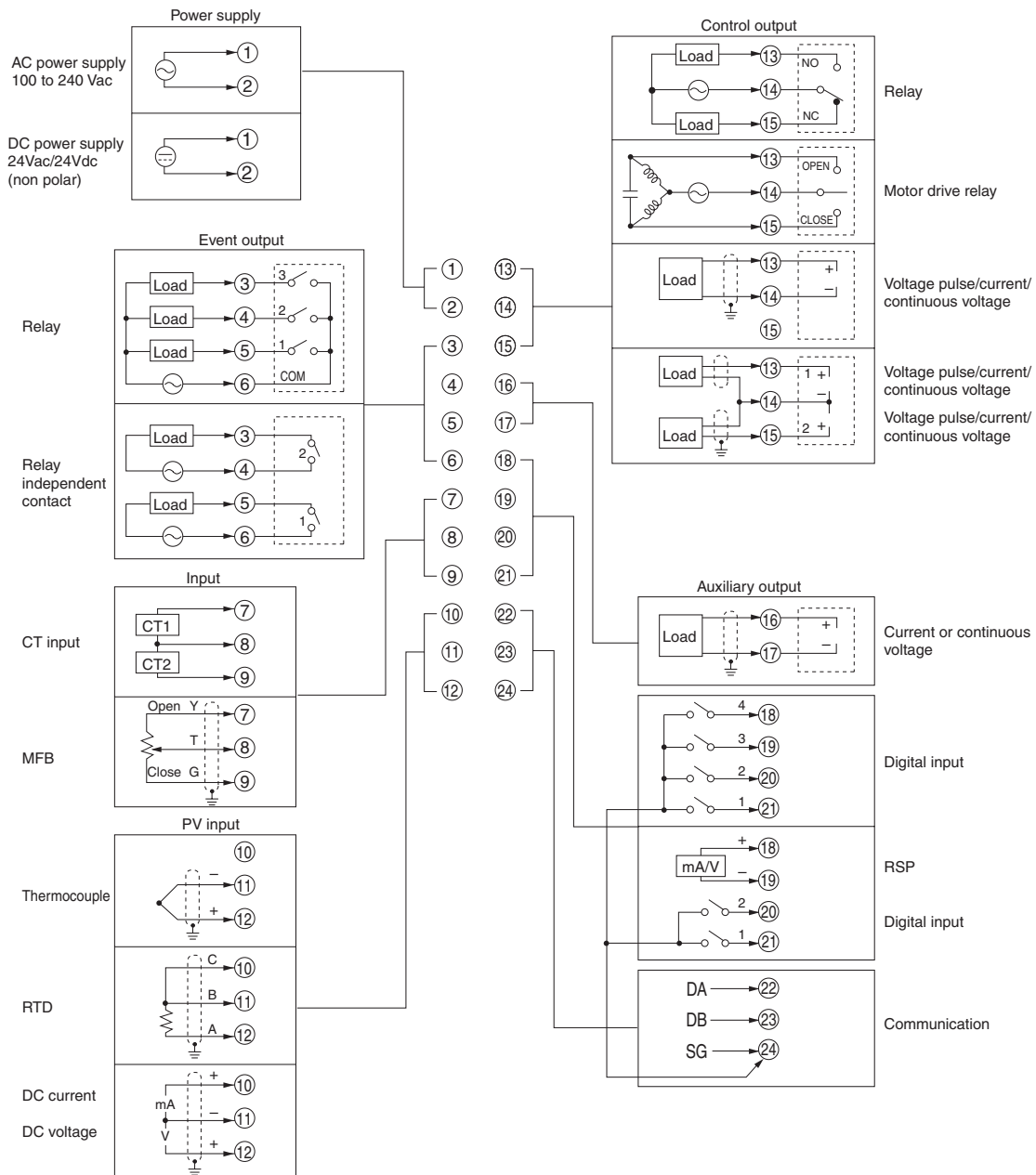

● Recommended crimp type terminal lugs

For wiring of C35/36, use an appropriate crimp type terminal lug suitable for the M3 screw.

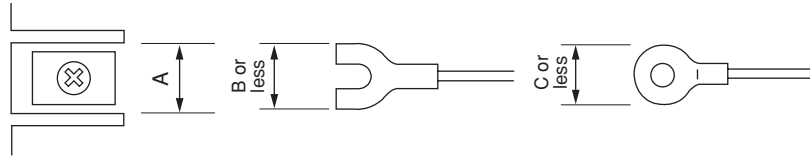

Applicable screw size	Terminal dimensions (mm)			Recommended crimp terminal	Applicable electrical	JST Mfg. Co.
	A	B	C	JIS indication	wire size	Model No. (Reference)
M3	6.1	5.8	5.8	RAV1.25 - 3	0.3 to 1.3mm ² AWG22 to 16	V1.25 - 3 V1.25 B3A

⚠ Handling Precautions

- When installing this unit in a place where the vibration or impact is large, always use an appropriate round crimp type terminal lug to avoid loose terminal connections.
- Pay special attention so that no crimp type terminal lugs are in touch with adjacent terminals.

■ Connection of open collector output to digital input

The following shows a connection example when connecting to four digital input points.

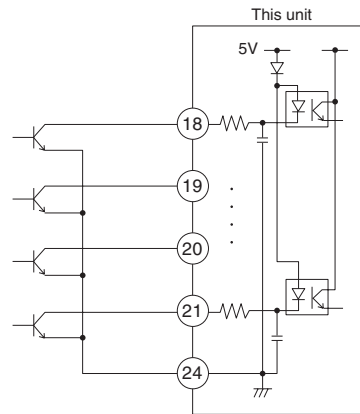

■ Connection of communication (RS-485) cable

● 3-wire system

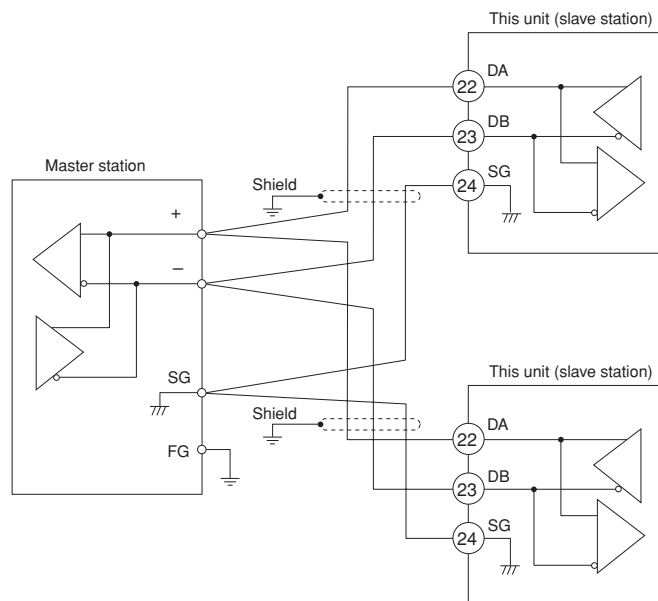

IMPORTANT Terminating resistor

- Do not connect any terminating resistor in the communication path. Doing so might cause the communication failure.
- Even though any units requiring the terminating resistor in the communication path, do not connect any terminating resistor.

! Handling Precautions

- Do not connect DA and DB. Doing so might cause damage to this unit.
- Ground the shield line to one point on one end of the cable.
- Be sure to connect SG terminals each other. Failure to do so might cause unstable communications.

● 5-wire system

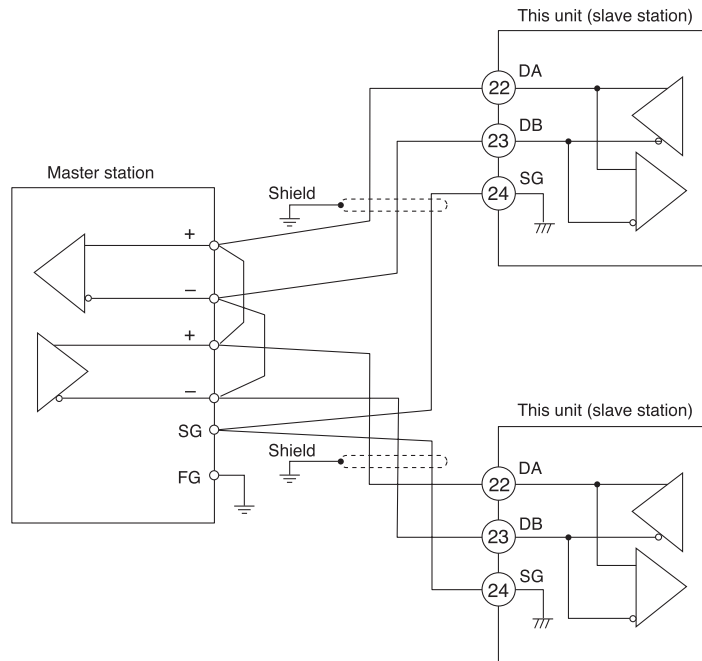

IMPORTANT Terminating resistor

- Do not connect any terminating resistor in the communication path. Doing so might cause the communication failure.
- Even though any units requiring the terminating resistor to exist in the communication path, do not connect any terminating resistor.

! Handling Precautions

- Do not connect DA and DB. Doing so might cause damage to this unit.
- Ground the shield line to one point on one end of the cable.
- Be sure to connect SG terminals each other. Failure to do so might cause unstable communications.

■ Connection with solid state relay (SSR)

To drive the SSR, a model having voltage pulse outputs (V0, VC, VV, or VD) must be used.

Generally, the SSR is classified into two groups, constant current type and resistor type.

● Constant current type

The two conditions listed below must be satisfied.

- Input current (maximum): Check that the input current is within the maximum allowable current or less, then the parallel connection can be made.
- Operating voltage range (input): Check that the voltage between the terminals of the voltage pulse output is within the specified range.

1. Azbil Corporation's PGM10N/PGM10F series

This example shows the calculation for the connection of the SDC35 and the PGM10N015.

(Note: For connection with other model number, check the specifications of each model.)

- Input current: Since the input current is 10mA or less, up to two units ($10\text{mA} \times 2 = 20\text{mA} < 24\text{mA}$ [maximum allowable current]) can be connected in parallel.
- Operating voltage range (input): The rating voltage is 3.5 to 30Vdc. Therefore, the voltage between the terminals is within the range.

$$\begin{aligned}
 &\text{Voltage between terminals (two PGM10N units)} \\
 &= \text{Open voltage} - \text{internal resistance} \times \text{total drive current} \\
 &= 19\text{Vdc} \pm 15\% - 82\Omega \pm 0.5\% \quad \times 20\text{mA} \\
 &\approx 15 \text{ to } 20\text{V}
 \end{aligned}$$

Connection diagram

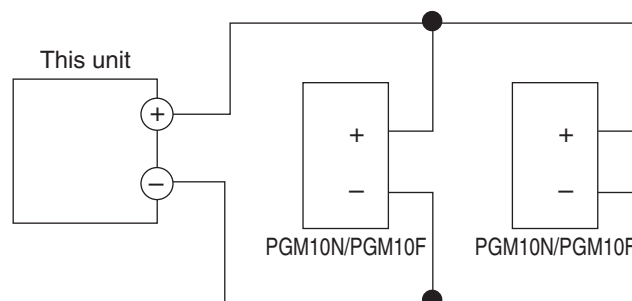

Number of connectable units

SSR to be used	Connection	V0 model	VV model
Azbil Corporatoin PGM10N	Parallel connection	Up to 2 units	Up to 4 units (Note)
Azbil Corporatoin PGM10F	Parallel connection	Up to 2 units	Up to 4 units (Note)

(Note) 2 units for each output

2. Omron's G3PA, G3PB, G3NA

- Input current: Since the input current is 7mA or less, up to three units (7mA X 3 = 21mA < 24mA [maximum allowable current]) can be connected in parallel.
- Operating voltage range (input): The rating voltage is 5 to 24Vdc or 12 to 24Vdc. Therefore, the voltage between the terminals is within the range.

Voltage between terminals (three G3PA units)
 = Open voltage - internal resistance X total drive current
 = 19Vdc ±15% - 82Ω ±0.5% X 21mA
 ≈ 14 to 20V

Connection diagram

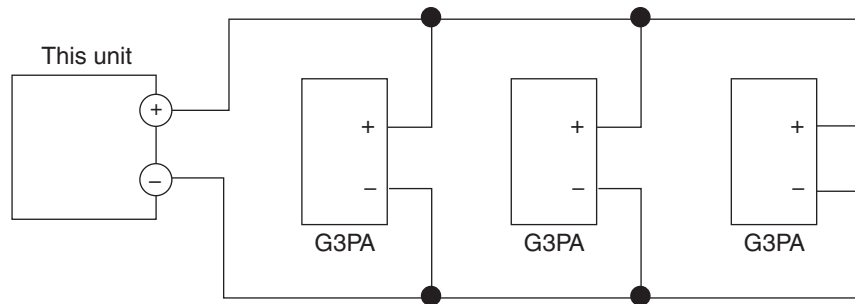

Number of connectable units

SSR to be used	Connection	V0 model	VV model
Omron G3PA	Parallel connection	Up to 3 units	Up to 6 units (Note)
Omron G3PB	Parallel connection	Up to 3 units	Up to 6 units (Note)
Omron G3NA	Parallel connection	Up to 3 units	Up to 6 units (Note)

(Note) 3 units for each output

● Resistor type (Azbil Corporation's PGM**2A1, etc.)

When necessary, an appropriate external resistor is connected in series so that the voltage between the input terminals of the SSR you are using is within the specified range.

(Example) Connection of two Azbil Corporation PGM units

Connection diagram

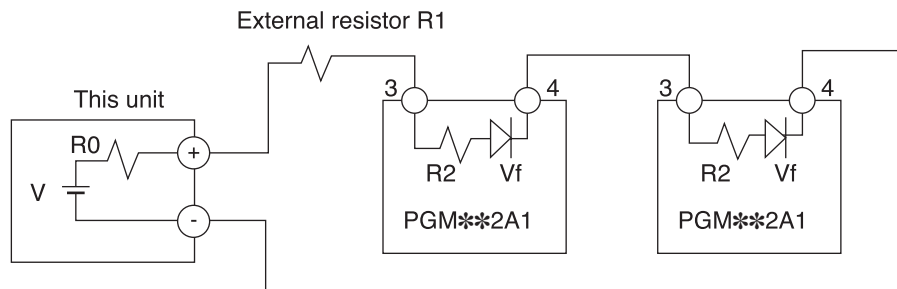

V: 19V ± 15%

R0: 82Ω ± 0.5%

R1: 680 Ω

R2: 260 Ω

Vf: 1.1V

$$\text{Voltage between terminals of PGM} = (V - 2 \times Vf) / (R0 + R1 + R2 + R2) \times R2 + Vf \approx 4.5 \text{ V}$$

Input voltage range of PGM: Since the input voltage range is 3 to 6V, the operation is possible.

External resistors

SSR to be used	Number of units to be connected	Connection	External resistor	Notes
PGM**2A1	1	-	1kΩ (series connection)	Rating is 1/2W or more.
	2	Series connection	680Ω (series connection)	Rating is 1/2W or more.
	3	Series connection	330Ω (series connection)	Rating is 1/2W or more.
	4	Series connection	None	

Number of connectable units

SSR to be used	Connection	V0 model	VV model
PGM**2A1	Series connection	Up to 4 units	Up to 8 units (Note)

(Note) 4 units for each output

■ Connection method for the motor drive relay output (R1)

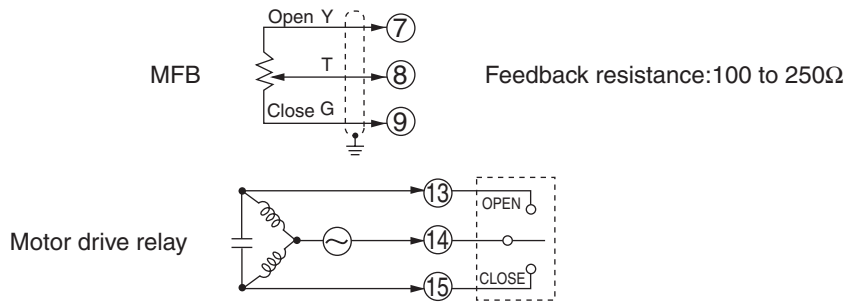

! Handling Precautions

- When a relatively high voltage (e.g., 100Vac) motor power supply is to be connected to the motor drive relay output, use a separate external relay in conjunction with the built-in relay.
- Do not run the cables of motor drive relay terminals 13, 14 and 15 together with the cables of MFB input terminals 7, 8 and 9 in the same conduit. Do not use one 6-core cable for all these connections. Doing so might cause a malfunction due to motor start-up noise.
- Avoid setting the PID control such that the output excessively repeats ON-OFF operations. Doing so might shorten the life of the built-in relay. If [C59: Motor long life mode] is set at “1,” the number of relay operations can be reduced with almost no influence on the control results.
- When [C57: Position proportional type] is set at “2” or “3,” connections to MFB terminals 7, 8 and 9 are not necessary. (This is the case of control without a feedback function.)
- When [C57: Position proportional type] is set at “0” or “1” with motor feedback function (MFB enabled), be sure to execute [C60: Motor auto adjust].
- When [C57: Position proportional type] is set at “2” or “3” without motor feedback function (MFB disabled), be sure to input the value of [C63: Motor full close – full open time] exactly.

■ Connection with current-input type controllers

When the power to this controller is turned off, the current input circuit is cut off. If multiple current-input type SDCs are connected in series and you want to turn them on/off individually, convert them to voltage input by adding resistors (No. 81401325, sold separately) to the circuit.

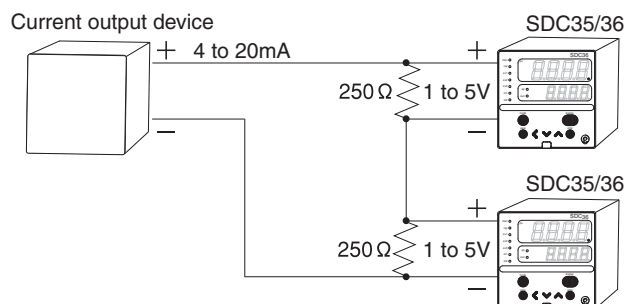

■ Wiring with zener barriers

Take the following notes into account if connecting an RTD to the PV input of the unit through a zener barrier.

- Be sure to adjust the zener barriers following the instructions in chapter 5. If the unit is adjusted in combination with recommended zener barriers, the indication accuracy of the PV input is up to $\pm 0.5\%$ FS ± 1 digit, depending upon the instrumentation conditions.
- Set the unit's PV input range to a value other than Nos. 53–62, so that the internal resistance of the zener barrier does not exceed the allowable resistance for the range.
- Use zener barriers recommended by Azbil Corporation. With zener barriers that do not meet the specifications below, accuracy may be dramatically degraded. If unrecommended zener barriers are used, contact the azbil Group.

Internal resistance $\leq 85\ \Omega$

(Note: Consider the wiring resistance as well as the internal resistance.)

Working voltage $\geq 1\ \text{V}$

Leakage current: $\leq 1\ \mu\text{A}$ (at 1 V)

Recommended zener barriers (for RTD)

Product No. 8907/22-02/120 (Azbil Corporation)

Product No. NZB3-1R75 (Nakamura Electric Mfg. Co., Ltd.)

Take the following note into account if connecting an Thermocouple to the PV input of the unit through a zener barrier.

- If the unit is adjusted in combination with recommended zener barriers, the indication accuracy of PV input is up to $\pm 0.5\%$ FS ± 1 digit, depending on the instrumentation conditions.
- Use zener barriers recommended by Azbil Corporation. With zener barriers that do not meet the specifications below, accuracy may be dramatically degraded. If unrecommended zener barriers are used, contact the azbil Group.

Working voltage $\geq 1\ \text{V}$

Leakage current: $\leq 1\ \mu\text{A}$ (at 1 V)

Recommended zener barriers (for TC)

Product No. 8907/22-05/110 (Azbil Corporation)

Product No. NZB2-1R52 (Nakamura Electric Mfg. Co., Ltd.)

■ Noise preventive measures

The power is taken from the single-phase instrument power supply to consider noise preventive measures.

If the noise from the power supply is large, an appropriate insulation transformer is added to the power supply and an appropriate line filter must be used.

(Azbil Corporation's line filter model No.: 81442557-001)

If the noise has a fast rising edge, an appropriate CR filter must be used.

(Azbil Corporation's CR filter model No.: 81446365-001)

⚠ Handling Precautions

After the noise preventive measures have been taken, do not bundle the primary and secondary sides of the insulation transformer together or lay/route them in the same conduit or duct.

4 - 2 Recommended Cables

Contact the thermocouple wires to the terminals in case of a thermocouple input. When a thermocouple is connected to terminals, or wiring distance is long, connect the wire via a shielded compensating lead wire.

- For input/output other than thermocouples, use a JCS 4364 instrument cable or equivalent (generally called twisted shielded cable for instrumentation use).

Recommended twisted shielded cables.

Fujikura Ltd.	2 conductors	IPEV-S-0.9mm ² X 1P
	3 conductors	ITEV-S-0.9mm ² X 1T
Hitachi Cable Co.	2 conductors	KPEV-S-0.9mm ² X 1P
	3 conductors	KTEV-S-0.9mm ² X 1T

- A shielded multiconductor microphone cord (MVVS) may be used, if electromagnetic induction noise are comparatively low.

Chapter 5. DETAILED DESCRIPTION OF EACH FUNCTION

5 - 1 PV Input

The following shows the functional block diagram of the PV input:

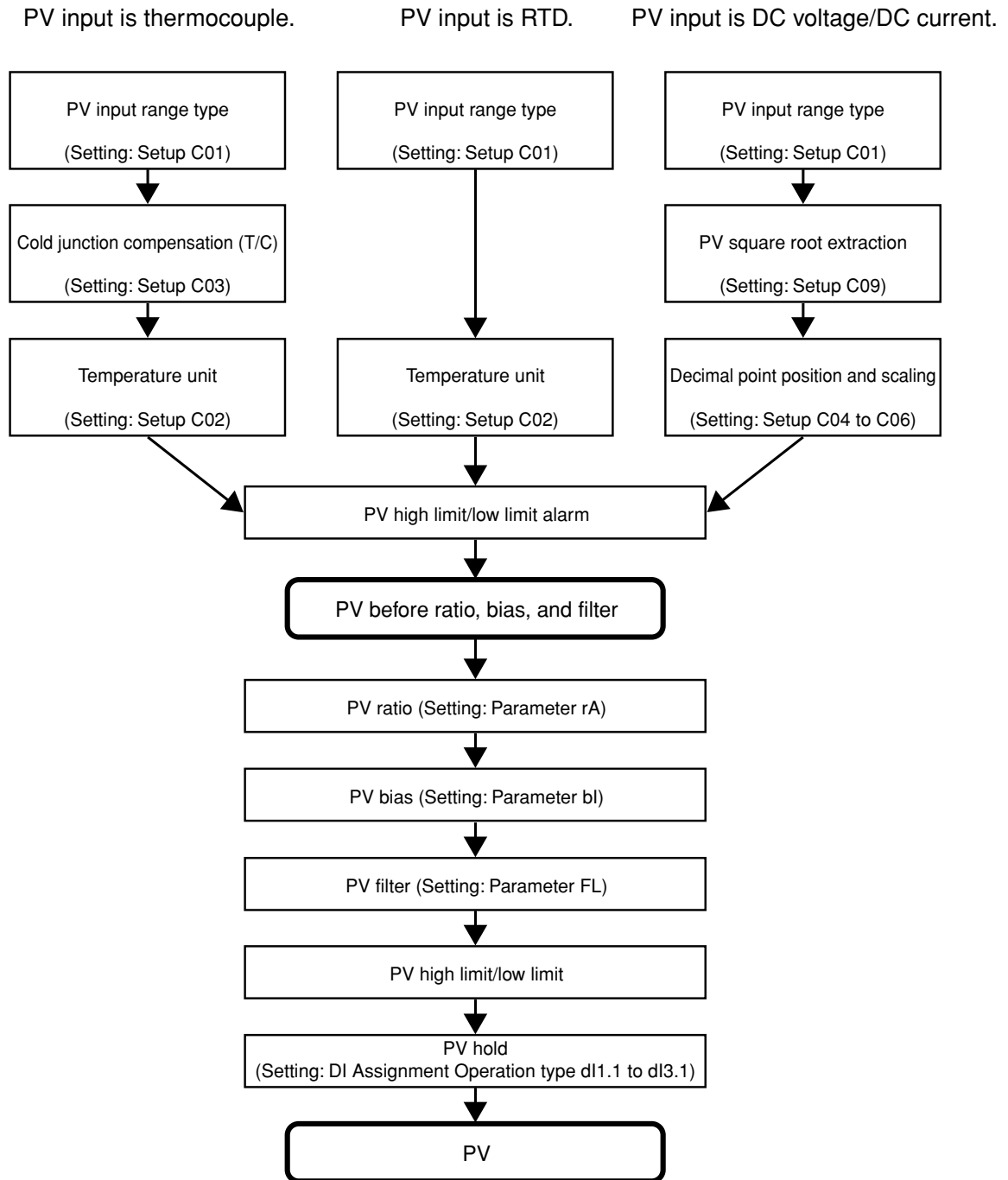

■ PV input range type

When the PV input range type is thermocouple or RTD, the sensor type and temperature range can be selected. When the PV input range type is DC voltage or DC current, the signal type can be selected.

Item (Bank)	Display	Contents	Initial value	User level
PV input range type (Setup bank)		Refer to the PV input range table.	88	Basic, Standard, High function

● PV input range table (Thermocouple)

C01 set value	Sensor type	Range (Celsius)	Range (Fahrenheit)	C04 display	C04 range*3	C04 initial value when C01 or C02 settings*4
1	K	-200 to +1200°C	-300 to +2200°F	----	Not setting	No decimal point
2	K	0 to 1200°C	0 to 2200°F	----	Not setting	No decimal point
3	K	0.0 to 800.0°C	0 to 1500°F	○	0 to 1	0
4	K	0.0 to 600.0°C	0 to 1100°F	○	0 to 1	1
5	K	0.0 to 400.0°C	0 to 700°F	○	0 to 1	1
6	K	-200.0 to +400.0°C	-300 to +700°F	○	0 to 1	1
7	K	-200.0 to +200.0°C	-300 to +400°F	○	0 to 1	1
8	J	0 to 1200°C	0 to 2200°F	----	Not setting	No decimal point
9	J	0.0 to 800.0°C	0 to 1500°F	○	0 to 1	1
10	J	0.0 to 600.0°C	0 to 1100°F	○	0 to 1	1
11	J	-200.0 to +400.0°C	-300 to +700°F	○	0 to 1	1
12	E	0.0 to 800.0°C	0 to 1500°F	○	0 to 1	1
13	E	0.0 to 600.0°C	0 to 1100°F	○	0 to 1	1
14	T	-200.0 to +400.0°C	-300 to +700°F	○	0 to 1	1
15	R	0 to 1600°C	0 to 3000°F	----	Not setting	No decimal point
16	S	0 to 1600°C	0 to 3000°F	----	Not setting	No decimal point
17	B	0 to 1800°C	0 to 3300°F	----	Not setting	No decimal point
18	N	0 to 1300°C	0 to 2300°F	----	Not setting	No decimal point
19	PL II	0 to 1300°C	0 to 2300°F	----	Not setting	No decimal point
20	WRe5-26	0 to 1400°C	0 to 2400°F	----	Not setting	No decimal point
21	WRe5-26	0 to 2300°C	0 to 4200°F	----	Not setting	No decimal point
22	Ni-NiMo	0 to 1300°C	0 to 2300°F	----	Not setting	No decimal point
23	PR40-20	0 to 1900°C	0 to 3400°F	----	Not setting	No decimal point
24	DIN U	-200.0 to +400.0°C	-300 to +700°F	○	0 to 1	1
25	DIN L	-100.0 to +800.0°C	-150 to +1500°F	○	0 to 1	1
26	Gold iron chromel	0.0K to 360.0K	0.0K to 360.0K	○	0 to 1	1

*1. The accuracy varies according to the range.

The accuracy of the B thermocouple is $\pm 4.0\%$ FS for a range of 260°C or less, $\pm 0.4\%$ FS for 260 to 800°C and $\pm 0.2\%$ FS for 800 to 1800°C.

The PV values under 20°C are not shown. The accuracy of the No. 15 (sensor type R) or No. 16 (sensor type S) is $\pm 0.2\%$ FS for a range of 100°C or less, and $\pm 0.15\%$ FS for 100 to 1600°C.

The accuracy of the No. 23 (sensor type PR40-20) is $\pm 2.5\%$ FS for 0 to of 300°C, and $\pm 1.5\%$ FS for 300 to 800°C, $\pm 0.5\%$ FS for 800 to of 1900°C.

The accuracy of the No. 26 (sensor type gold iron chromel) is $\pm 1.5\%$ K.

The accuracy of the No. 55 to 62 and 81 are $\pm 0.15\%$ FS for each ranges.

The accuracy of the No. 19 (sensor type PLII) in the range of 0 to 32°F does not meet the indication accuracy.

*2. Make sure to set the correct number in setup display C01, according to the type and range of the sensor used. If the setting is wrong, problems such as large temperature errors in the output may occur.

*3. "Not setting" fixed when Fahrenheit settings.

*4. "No decimal point" fixed when Fahrenheit settings.

● PV input range table (RTD)

C01 set value	Sensor type	Range (Celsius)	Range (Fahrenheit)	C04 display	C04 range*3	C04 initial value when C01 or C02 settings*4
41	Pt100	-200.0 to +500.0°C	-300 to +900°F	○	0 to 1	1
42	JPt100	-200.0 to +500.0°C	-300 to +900°F	○	0 to 1	1
43	Pt100	-200.0 to +200.0°C	-300 to +400°F	○	0 to 1	1
44	JPt100	-200.0 to +200.0°C	-300 to +400°F	○	0 to 1	1
45	Pt100	-100.0 to +300.0°C	-150 to +500°F	○	0 to 1	1
46	JPt100	-100.0 to +300.0°C	-150 to +500°F	○	0 to 1	1
47	Pt100	-100.0 to +200.0°C	-150 to +400°F	○	0 to 1	1
48	JPt100	-100.0 to +200.0°C	-150 to +400°F	○	0 to 1	1
49	Pt100	-100.0 to +150.0°C	-150 to +300°F	○	0 to 1	1
50	JPt100	-100.0 to +150.0°C	-150 to +300°F	○	0 to 1	1
51	Pt100	-50.0 to +200.0°C	-50 to +400°F	○	0 to 1	1
52	JPt100	-50.0 to +200.0°C	-50 to +400°F	○	0 to 1	1
53	Pt100	-50.0 to +100.0°C	-50 to +200°F	○	0 to 1	1
54	JPt100	-50.0 to +100.0°C	-50 to +200°F	○	0 to 1	1
55	Pt100	-60.0 to +40.0°C	-60 to +100°F	○	0 to 1	1
56	JPt100	-60.0 to +40.0°C	-60 to +100°F	○	0 to 1	1
57	Pt100	-40.0 to +60.0°C	-40 to +140°F	○	0 to 1	1
58	JPt100	-40.0 to +60.0°C	-40 to +140°F	○	0 to 1	1
59	Pt100	-10.00 to +60.00°C	-10 to +140°F	○	0 to 2	2
60	JPt100	-10.00 to +60.00°C	-10 to +140°F	○	0 to 2	2
61	Pt100	0.0 to 100.0°C	0 to 200°F	○	0 to 1	1
62	JPt100	0.0 to 100.0°C	0 to 200°F	○	0 to 1	1
63	Pt100	0.0 to 200.0°C	0 to 400°F	○	0 to 1	1
64	JPt100	0.0 to 200.0°C	0 to 400°F	○	0 to 1	1
65	Pt100	0.0 to 300.0°C	0 to 500°F	○	0 to 1	1
66	JPt100	0.0 to 300.0°C	0 to 500°F	○	0 to 1	1
67	Pt100	0.0 to 500.0°C	0 to 900°F	○	0 to 1	1
68	JPt100	0.0 to 500.0°C	0 to 900°F	○	0 to 1	1

● PV input range table (DC voltage/DC current)

C01 set value	Sensor type	Range (C05, C06)	C04 display	C04 range	C04 initial value when C01 settings
81	0 to 10mV	• Scaling range is -1999 to +9999. • When C01 is changed, the range (C05, C06) default defaults to 0 to 1000.	○	0 to 3	No change
82	-10 to +10mV		○	0 to 3	No change
83	0 to 100mV		○	0 to 3	No change
84	0 to 1V		○	0 to 3	No change
86	1 to 5V		○	0 to 3	No change
87	0 to 5V		○	0 to 3	No change
88	0 to 10V		○	0 to 3	No change
89	0 to 20mA		○	0 to 3	No change
90	4 to 20mA		○	0 to 3	No change

 **Handling Precautions**

- When the C01 PV input range number is set, the decimal point position and range are initially set automatically as shown in the tables. For details on the decimal point, refer to the description of setup C04 (decimal point position) on page 5-5.
- Make sure to set the correct number in setup display C01, according to the type and range of the sensor used. If the setting is wrong, problems such as large temperature errors in the output may occur.
- For details about the accuracy of each PV range type,  Chapter 13, SPECIFICATIONS (on page 13-1).

■ Temperature unit

When the PV input range type is thermocouple or RTD, the temperature unit can be selected.

Item (Bank)	Display	Contents	Initial value	User level
Temperature unit (Setup bank)		0: Celsius (°C) 1: Fahrenheit (°F).	0	Basic, Standard, High function

- When the PV input range type is thermocouple or RTD, the display and setting can be configured.

■ Cold junction compensation (T/C)

When the PV input range type is thermocouple, either of the following can be selected:

- The cold junction compensation (T/C) is performed inside this unit.
- The cold junction compensation (T/C) is not performed inside this unit since an external cold junction compensation unit, such as ice bath is used.

Item (Bank)	Display	Contents	Initial value	User level
Cold junction compensation (T/C) (Setup bank)		0: Cold junction compensation (T/C) is performed (internal). 1: Cold junction compensation (T/C) is not performed (external).	0	High function

- When the PV input range type is thermocouple, the display and setting can be configured.

■ PV square root extraction dropout

When the PV input range type is DC voltage or DC current, a dropout value can be set so that the result of the PV square root extraction used to convert the pressure (differential pressure) into the flow becomes "0".

Item (Bank)	Display	Contents	Initial value	User level
PV square root extraction dropout (Setup bank)		0.0%: Square root extraction is not performed. 0.1 to 100.0%	0.0%	High function

- When the PV input range type is DC voltage or DC current, the display and setting can be made.
- Details of PV square root extraction
The calculation input in % and the calculation result in % are expressed as PVin and PVout, respectively.
When the PV input is the PV square root extraction dropout set value or more and less than 100.0%, the control formula becomes as shown below.
$$PV_{out} = \sqrt{PV_{in}/100} \times 100$$

When the PV input is larger than 0.0% and smaller than the PV square root extraction dropout set value, PVout = 0.0%.
When the PV input is 0.0% or less or 100.0% or more, the square root extraction is not performed. Therefore, PVout = PVin.

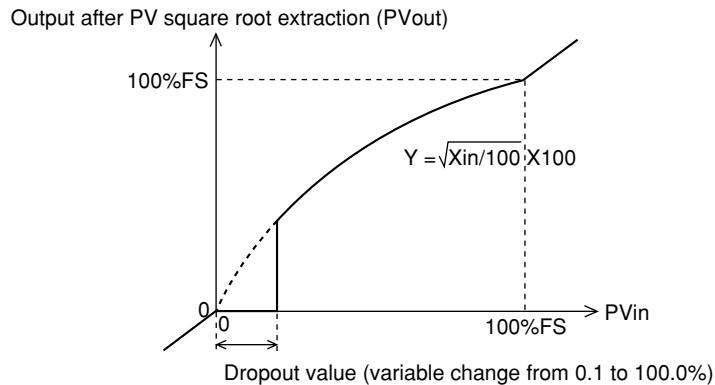

■ Decimal point position

When the PV input range type is DC voltage or DC current or when the PV input range type is a part of the PV input range type of thermocouple or RTD, the decimal point position of the PV input can be set.

Item (Bank)	Display	Contents	Initial value	User level
Decimal point position (Setup bank)		0: No decimal point 1: 1 digit after decimal point 2: 2 digits after decimal point 3: 3 digits after decimal point	0	Basic, Standard, High function

⚠ Handling Precautions

- As this setting is changed, the decimal point position of the parameters related to the decimal point position of the PV input is also changed. Actually, the decimal point position of the following settings are changed:
 - SP setting
 - SP low limit/high limit setting
 - RSP range low limit/high limit setting
 - SP ramp-up/ramp-down setting
 - Event setting and continuous output setting related to PV
 - Event setting and continuous output setting related to SP
 - Event setting and continuous output setting related to deviation (absolute deviation)
- When the PV input range is set to 3 (K thermocouple 0.0 to 800.0°C), the decimal point position is 0. This exception ensures compatibility if PV range type 3 is K thermocouple 0–800°C without a decimal point, which is the case when ROM version 1 of the instrument information bank(1202) is prior to 2.04.

📖 Note

- For the display conditions, setting range and initial value of range numbers (C01),
 - ☞ ■ PV Input range type (on page 5-2).

■ PV input range low limit/high limit

When the PV input range type is DC voltage or DC current, the scaling of the PV input can be set.

Item (Bank)	Display	Contents	Initial value	User level
PV input range low limit (Setup bank)	$\overline{C} 05$	When the PV input range type is DC voltage or DC current, the following contents apply: -1999 to +9999 (no decimal point) -199.9 to +999.9 (1 digit after decimal point) -19.99 to +99.99 (2 digits after decimal point) -1.999 to +9.999 (3 digits after decimal point) When the PV input type is thermocouple or RTD, the range low limit and high limit values selected using the PV input range type are used.	0	Basic, Standard, High function
PV input range high limit (Setup bank)	$\overline{C} 06$		1000	

- When the PV input range type is thermocouple or RTD, the setting item can be displayed, but the setting cannot be made.
- When the PV input range type is DC voltage or DC current, the display and setting can be made.

The following describes the relationship between the PV input and PV when setting up the range low limit and high limit:

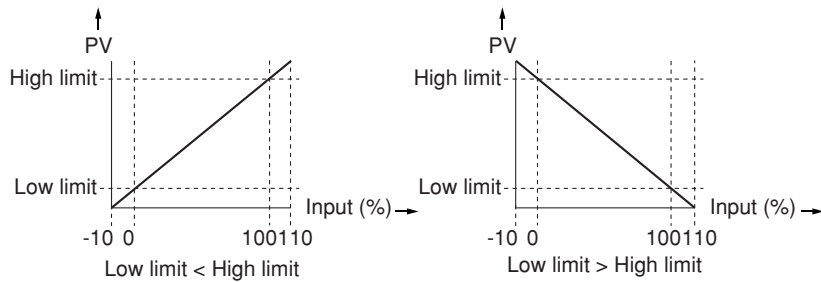

■ PV ratio and PV bias

The PV ratio and PV bias can be set to compensate the PV.

Item (Bank)	Display	Contents	Initial value	User level
PV ratio (Parameter bank)	rR	0.001 to 9.999	1.000	Standard, High function
PV bias (Parameter bank)	bI	-1999 to +9999 U	0U	Basic, Standard, High function

- Details of PV ratio and PV bias controls

Assuming that the control input is PV_{in}, control result is PV_{out}, PV ratio is RA, and PV bias is BI, the following control formula is obtained:

$$PV_{out} = (PV_{in} \times RA) + BI$$

■ PV low limit alarm threshold

Item (bank)	Display	Contents	Initial value	User level
PV input failure (under range) type	$\overline{C} 97$	0: -10 %FS 1: -5 mV	0	Simple, Standard, High function

If ROM version 1 in the instrument information bank ($\overline{I} 002$) is 2.26 or earlier, this item cannot be displayed.

This setting is applicable if $\overline{C} 01$ (PV input range type) is set for sensor type B (No. 17) or PR40-20 (No. 23).

☞ ■ PV low limit/high limit and PV low limit/high limit alarms (on page 5-7)

■ PV filter

This PV filter is a primary delay filter to be used if the PV repeatedly fluctuates rapidly and the control cannot be performed or if the PV fluctuates finely due to influence of noise, etc.

As a larger value is set, it becomes difficult to change the PV used for the control of this unit.

Normally, the PV filter is used with an initial value of "0.0".

Item (Bank)	Display	Contents	Initial value	User level
PV filter (Parameter bank)	<i>FL</i>	0.0: No filter 0.1 to 120.0s	0.0s	Basic, Standard, High function

$$OUT = OUT_{-1} + (IN - OUT_{-1}) / (T / T_s + 1)$$

IN: Input to filter

OUT: Control output of current filter

OUT₋₁: Control output of previous filter

T: Filter set value (s)

T_s: Sampling cycle time (0.1s)

■ PV hold

It is possible to set the PV to a fixed value using the PV hold, PV Max. hold, and PV Min. hold of the digital input (DI) functions.

PV hold: PV is set to a fixed value and it is not updated.

PV Max. hold: PV maximum value is held.

The PV value is updated only when the new PV value is larger than the currently held value.

PV Min. hold: PV minimum value is held.

The PV value is updated only when the new PV value is smaller than the currently held value.

When using the PV hold, PV Max. hold, or PV Min. hold, the PV indication on the upper display is flashing.

■ PV low limit/high limit and PV low limit/high limit alarms

PV low limit and PV high limit are provided for each PV input range type.

In principle, -10%FS of each range becomes the PV low limit while +110%FS becomes the PV high limit.

For details,

 ■ Behavior in case of PV input failure (on page 10-3).

The PV is limited so that it is within a range between the PV low limit and PV high limit.

If the PV before activation of the PV ratio, PV bias, and PV filter is larger than the PV high limit, PV high limit alarm (AL01) occurs. On the contrary, if this PV is smaller than the PV low limit, the PV low limit alarm (AL02) occurs.

■ Zener barrier adjustment

When the PV input is RTD and uses the Zener barrier, the Zener barrier needs to be adjusted. Additionally, if three wiring resistances to the PV input terminal have any variation even though the Zener barrier is not used, the Zener barrier must also be adjusted.

When using an input other than RTD, this adjustment is not needed and cannot be performed.

Item (Bank)	Display	Contents	Initial value	User level
Special function (Setup bank)		0 to 15 5: Zener barrier adjustment enabled.	0 (This value becomes zero (0) when the power is turned ON.)	High function
Zener barrier adjustment (Setup bank)		-20.000 to +20.00Ω (However, “-20.00” is displayed as “-19.99”.) The value can be changed with the adjustment. The numeric value cannot be directly input with the manual operation.	0.00Ω	High function

● Adjusting procedures

Follow the steps below to adjust the Zener barrier.

- (1) Turn off the power to the unit and apply wiring No. 1. To adjust the long wires without a zener barrier, apply wiring No. 2.

Applicable PV range type	Wiring status	Wiring contents
41 to 52, 63 to 68	1	Remove the RTD, connect a 1000.00 Ω resistor between zener barriers A and B, and connect B to C. For connections, use resistors that meet the following specifications. Allowable tolerance: ±0.05 %. Rated power: 0.1 W minimum. Recommended resistor: C2610E (100 Ω) made by PCN Corporation
41 to 68	2	Remove the RTD from between the extension wires, connect a 1000.00 Ω resistor between zener barriers A and B, and connect B to C.
41, 42, 45, 46, 65 to 68	3	Connect zener barriers A and B at the RTD terminals.

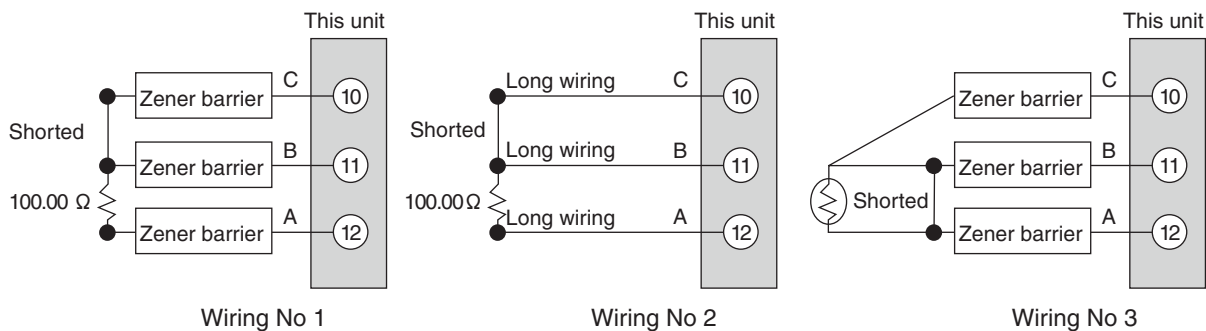

- (2) Turn ON the power to the unit and set “5” to [C88: Special function].

- (3) Display [C89: Zener barrier adjustment].

[!] Handling Precautions

(If [C01: PV range type] is not RTD or if [C88: Special function] is other than "5", [C89: Zener barrier adjustment] is not displayed.)

- (4) Press the [enter] key to display a difference in wiring resistance between the A and B lines on the lower display.
- (5) Press the [enter] key to store the difference in wiring resistance between the A and B lines into this unit as an adjustment value.
- (6) Turn OFF the power to the unit and connect the RTD correctly.

[!] Handling Precautions

- The Zener barrier can be used only when the PV range type is 41 to 52 or 63 to 68.
- Use a Zener barrier whose resistance is low enough so that the total resistance, including wiring resistance, is 85 Ω or less.
- Adjust the Zener barrier with a resistance difference between the Zener barrier and long extension wiring of 20 Ω or less. If this resistance difference is 20 Ω or more, the Zener barrier cannot be adjusted and the adjustment value becomes 0.00 Ω .
- Once the Zener barrier has been adjusted, the correction is performed with the same adjustment value even though the PV range type is changed to other RTD.
- To return the adjusted value to 0.00 Ω , connect PV input terminals 10 and 11, leaving terminal 12 open, and follow the above steps (2) to (5).
- Notes for products with S/N 133220_ _ _
 - Be sure to adjust the unit with wiring No. 1. If the unit is adjusted with wiring No. 3, poor accuracy may result.
 - Use zener barriers recommended by Azbil Corporation. If the unit is used with unrecommended zener barriers, accuracy may be drastically impaired. Before using such zener barriers, contact the azbil Group.

5 - 2 Mode

It is possible to set the AUTO/MANUAL mode selection, RUN/READY mode selection, LSP/RSP mode selection, Auto Tuning (AT) stop/start selection, release all digital output (DO) latches, and OFF/ON selection of communication digital input 1 (communication DI 1).

■ AUTO/MANUAL mode

The AUTO/MANUAL mode selection can be set.

Item (Bank)	Display	Contents	Initial value	User level
AUTO/MANUAL (Mode bank)	A--M	AUto: AUTO mode [Communication value is "0".] MAn: MANUAL mode [Communication value is "1".]	AUto	Basic, Standard, High function

- When the AUTO/MANUAL mode is changed, the display is automatically returned to the operation display.
- If the operation type of internal contacts 1 to 5 is set at "AUTO/MANUAL", [A--M: AUTO/MANUAL] can be displayed, but the setting cannot be configured.
- When [Ctrl: Control method] is set at "0" (ON/OFF control), [A--M: AUTO/MANUAL] cannot be displayed and set.
- When [bit 0: AUTO/MANUAL display] of [C73: MODE display setup] is set at "0" (no display), [A--M: AUTO/MANUAL] cannot be displayed and set.

■ RUN/READY mode

The RUN/READY mode selection can be set.

Item (Bank)	Display	Contents	Initial value	User level
RUN/READY (Mode bank)	r--r	rUn: RUN mode [Communication value is "0".] rdy: READY mode [Communication value is "1".]	rUn	Basic, Standard, High function

- If the operation type of internal contacts 1 to 5 is set at "RUN/READY", [r--r: RUN/READY] can be displayed, but the setting cannot be configured.
- When [bit 1: RUN/READY display] of [C73: MODE display setup] is set at "0" (no display), [r--r: RUN/READY] cannot be displayed and set.

■ LSP/RSP mode

The LSP/RSP mode selection can be set.

Item (Bank)	Display	Contents	Initial value	User level
LSP/RSP (Mode bank)	L--r	LSP: LSP mode [Communication value is "0".] RSP: RSP mode [Communication value is "1".]	LSP	Basic, Standard, High function

- If the operation type of internal contacts 1 to 5 is set at "LSP/RSP", [L--r: LSP/RSP] can be displayed, but the setting cannot be configured.
- When [bit 2: LSP/RSP display] of [C73: MODE display setup] is set at "0" (no display), [L--r: LSP/RSP] cannot be displayed and set.
- If the model does not have the RSP mode, [L--r: LSP/RSP] cannot be displayed and set.

■ Auto tuning (AT) stop/start

The AT stop/start selection can be set.

Item (Bank)	Display	Contents	Initial value	User level
Auto Tuning (AT) stop/start (Mode bank)	<i>At</i>	At.oF: AT stop [Communication value is "0".] At.on: AT start [Communication value is "1".]	At.oF	Basic, Standard, High function

- The AT is stopped in the MANUAL or READY mode.
- If the PV high limit alarm (AL01) or PV low limit alarm (AL02) occurs, the AT is stopped.
- If the operation type of internal contacts 1 to 5 is set at "AT stop/start", [At: AT stop/start] can be displayed, but the setting cannot be made.
- When [Ctrl: Control method] is set at "0" (ON/OFF control), [At: AT stop/start] cannot be displayed and set.
- When [bit 3: AT stop/start display] of [C73: MODE display setup] is set at "0" (no display), [At: AT stop/start] cannot be displayed and set.

For details about AT,

 ■ Auto turning (AT) (on page 5-26) and 5-4 Auto Tuning (AT) Function (on page 5-29).

■ Release all digital output (DO) latches

Release all digital output (DO) latches can be set.

Item (Bank)	Display	Contents	Initial value	User level
Release all digital output (DO) latches (Mode bank)	<i>do.Lt</i>	Lt.on: Latch is continued. [Communication value is "0".] Lt.oF: Latch is released. [Communication value is "1".]	Lt.on	Basic, Standard, High function

- If the operation type of internal contacts 1 to 5 is set at "Release all DO latches", [do.Lt: Release all DO latches] can be displayed, but the setting cannot be configured.
- When [bit 4: Release all DO latches display] of [C73: MODE display setup] is set at "0" (no display), [do.Lt: Release all DO latches] cannot be displayed and set.

■ Communication digital input 1 (communication DI 1)

Communication digital input 1 (communication DI 1) can be set.

Item (Bank)	Display	Contents	Initial value	User level
Communication digital input 1 (communication DI 1) (Mode bank)	<i>C.DI 1</i>	DI.oF: Communication DI1. OFF [Communication value is "0".] DI.on: Communication DI1. ON [Communication value is "1".]	DI.oF	Basic, Standard, High function

- Four communication DIs, DI1 to DI4, are provided. However, only communication DI 1 can be set using the key operation.
- The function (operation) with communication DI 1 can be set using the DI Assignment.
- When [bit 5: Communication DI 1 display] of [C73: MODE display setup] is set at "0" (no display), [C.DI1: Communication DI 1] cannot be displayed and set.

5 - 3 Control

The following shows the functional block diagram of the control (ON/OFF control, PID control, RationalLOOP control, and Heat/Cool control, etc.):

ON/OFF control

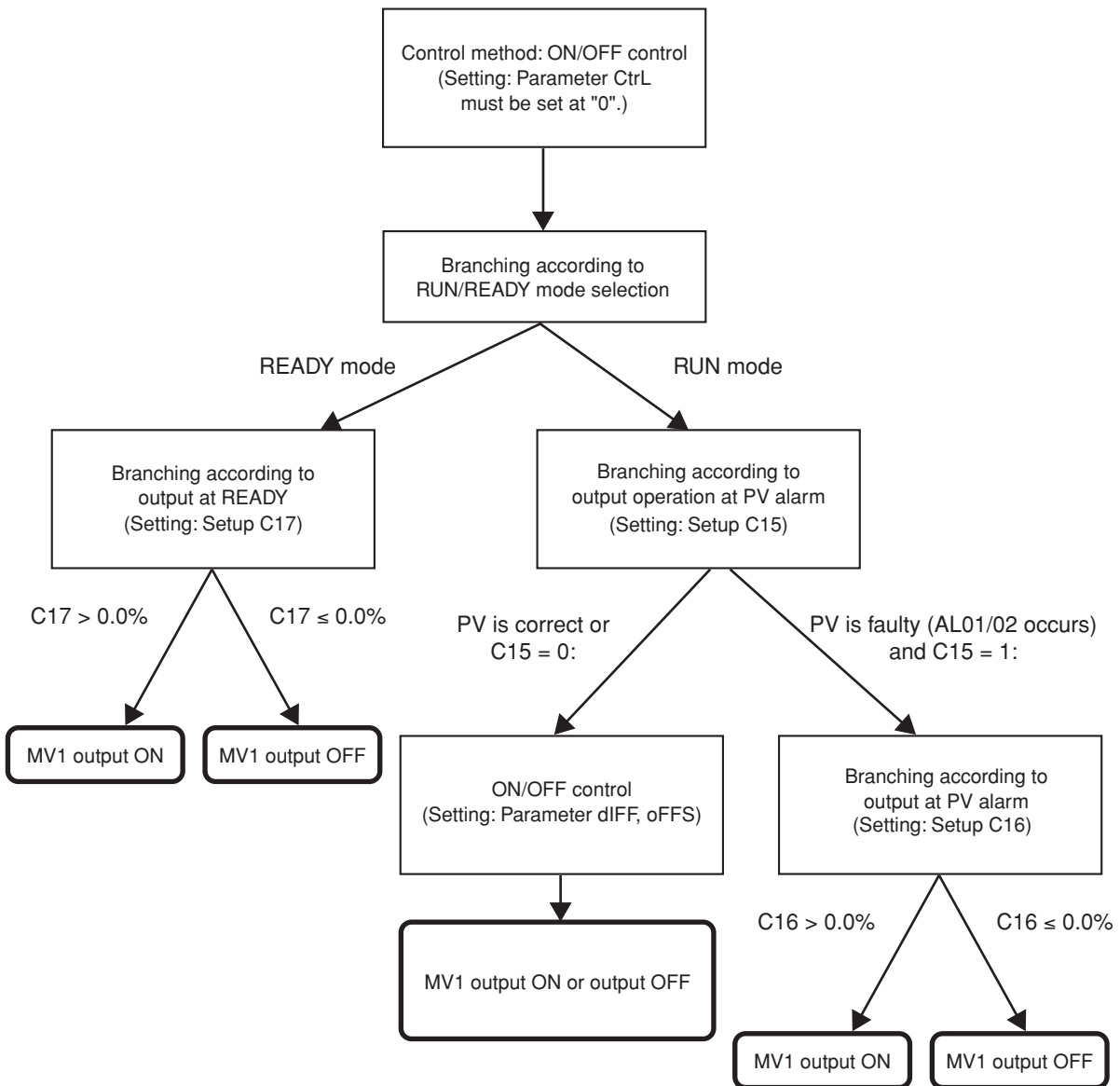

Note

When the control output type is R1 (motor drive relay output), the ON/OFF control is not enabled.

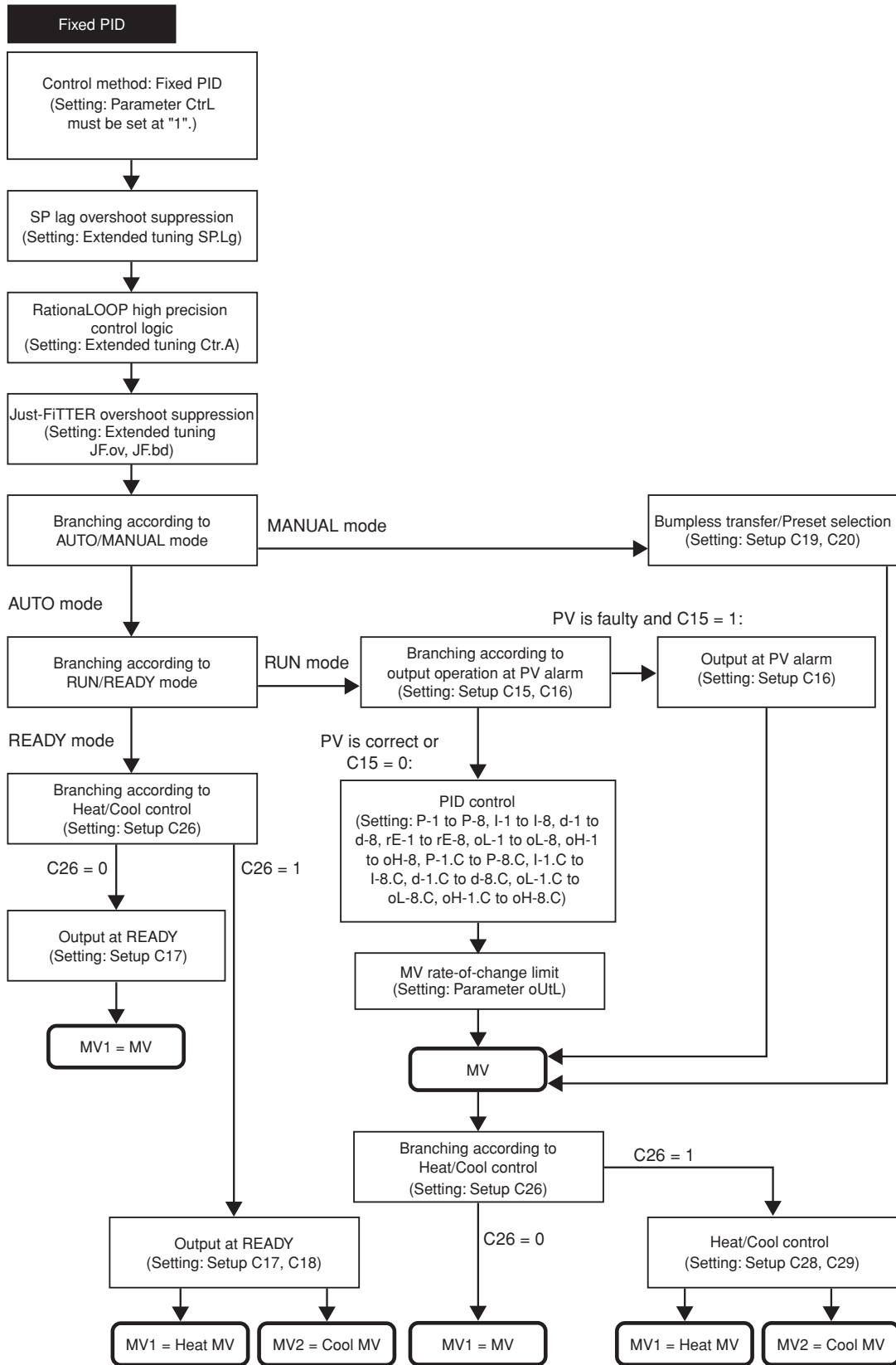

Note

When the control output type is R1 (motor drive relay output), the Heat/Cool control is not enabled.

■ Control method

A desired control method can be selected from two kinds of control methods.

Item (Bank)	Display	Contents	Initial value	User level
Control method (Parameter bank)		0: ON/OFF control 1: Fixed PID	0 or 1	Basic, Standard, High function

- When the control output type is the position proportional output, only [1: Fixed PID] can be selected.
- When the control output type is relay (R0), the initial value becomes "0". The initial value is "1" in other cases.
- "Fixed" of [1: Fixed PID] means that the PID constant is not changed automatically since the self-tuning (ST) provided for SDC15 is not run. However, the AT can be run even in the fixed PID control.
- The following table shows valid and invalid functions related to [1: Fixed PID], as well as other related parameters:

Classification of Heat/Cool control	Classification of RationalLOOP	Classification of control action	RationalLOOP function	AT	Just-FITTER
Normal control	Normal PID	P control	X	○*	X
		PI control	X	○*	○
		PD control	X	○*	X
		PID control	X	○	○
	RationalLOOP	P control	X	○*	X
		PI control	X	○*	○
		PD control	X	○*	X
		PID control	○	○	○
Heat/Cool control	Normal PID	P control	X	○*	X
		PI control	X	○*	○
		PD control	X	○*	X
		PID control	X	○	○
	RationalLOOP	P control	X	○*	X
		PI control	X	○*	○
		PD control	X	○*	X
		PID control	○	○	○
Notes				*Adjustment result becomes the PID control.	
Related settings			Control algorithm	AT type	Just-FITTER overshoot limit/restraint/control coefficient
				MV low limit at AT	Just-FITTER settling band
				MV high limit at AT	
				AT Proportional band adjust	
				AT Integral time adjust	
				AT Derivative time adjust	

■ Control action and Heat/Cool control

The control action (direct/reverse) and Heat/Cool control (enabled/disabled) can be selected.

However, when the control output type is R1 (motor drive relay output), the Heat/Cool control is not enabled.

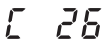
Item (Bank)	Display	Contents	Initial value	User level
Control action (direct/reverse) (Setup bank)		0: Heat control (Reverse) 1: Cool control (Direct)	0	Basic, Standard, High function
Heat/Cool control (Setup bank)		0: Disabled. 1: Enabled.	0	Basic, Standard, High function

- When the control output type is other than R1 (motor drive relay output), and when the control method is other than the ON/OFF control (Ctrl ≠ 0), [C26: Heat/Cool control] can be displayed and set.
However, in case of the position proportional control model, the Heat/Cool control is not enabled.
- When the Heat/Cool control is set disabled (C26 = 0), [C14: Control action] can be displayed and set.
- When the Heat/Cool control is set disabled (C26 = 0), both [C20: Preset MANUAL value] and [C22: Initial output of PID control] are changed to "0.0".
- When the Heat/Cool control is set enabled (C26 = 1), both [C20: Preset MANUAL value] and [C22: Initial output of PID control] are changed to "50.0".
- The reverse action (heat control) is a control that decreases (or turns OFF) the manipulated variable (MV) as the PV increases.
The direct action (cool control) is a control that increases (or turns ON) the manipulated variable (MV) as the PV increases.

■ Special control outputs

The control output at PV alarm and control output at READY can be set.

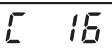
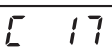
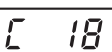
Item (Bank)	Display	Contents	Initial value	User level
Output operation at PV alarm (Setup bank)		0: Control calculation is continued. 1: Output at PV alarm is output.	0	High function
Output at PV alarm (Setup bank)		-10.0 to +110.0%	0.0%	High function
Output at READY (Heat) (Setup bank)		-10.0 to +110.0%	0.0%	Standard, High function
Output at READY (Cool) (Setup bank)		-10.0 to +110.0%	0.0%	Standard, High function

- When the control method is other than the ON/OFF control (Ctrl ≠ 0) and the Heat/Cool control is set enabled (C26 = 1), [C18: Output at READY (cool)] can be displayed and set.
- The PV alarm status means that AL01, 02, or 03 occurs.

■ MANUAL mode change

The control output when the AUTO mode is changed to the MANUAL mode can be set.

Item (Bank)	Display	Contents	Initial value	User level
Output operation at changing Auto/Manual (Setup bank)	[19	0: Bumpless transfer 1: Preset	0	Standard, High function
Preset MANUAL value (Setup bank)	[20	-10.0 to +110.0%	0.0 or 50.0%	Standard, High function

- When [C19: Output operation at changing Auto/Manual] is set at [0: Bumpless transfer], the manipulated variable (MV) when the AUTO mode is changed to the MANUAL mode is retained. When set at [1: Preset], the manipulated variable (MV) is set to [C20: Preset MANUAL value] when the AUTO mode is changed to the MANUAL mode.
- When the control method is other than ON/OFF control (Ctrl ≠ 0), [C19: Output operation at changing Auto/Manual] and [C20: Preset MANUAL value] can be displayed and set.
- When the Heat/Cool control is not used (C26 = 0), the initial value of [C20: Preset MANUAL value] is [0.0]. On the contrary, when the Heat/Cool control is used (C26 =1), this initial value becomes [50.0].

! Handling Precautions

When the unit is in the MANUAL mode if the power is turned ON, the set value of C20 becomes the initial manipulated variable (MV).

■ PID control initialization

Item (Bank)	Display	Contents	Initial value	User level
Initial output type (mode) of PID control (Setup bank)	[21	0: Auto 1: Not initialized. 2: Initialized. (If SP value different from the current value is input.)	0	High function

- When the control method is other than the ON/OFF control (Ctrl≠0), the display and setting can be performed.
- If the PID group is changed as the SP value or SP group is changed, the manipulated variable (MV) is stopped at its low limit or high limit, and then the PV may not change or may overshoot. To prevent such trouble, it is effective to initialize the PID control.
- The setting is “0” (Auto).
It is judged automatically whether or not the PID control needs to be initialized as the SP value or SP group is changed. As a result, the PID control is initialized only when it is required.
- The setting is “1” (Not initialized).
Even though the SP value or SP group is changed, the PID control is not initialized. This setting is effective when the continuation of the manipulated variable (MV) is important if the SP value or SP group is changed.
- The setting is “2” (Initialized).
Every time the SP value or SP group is changed, the PID control is always initialized. This setting is effective when it is important that an increase or a decrease in manipulated variable (MV) immediately affects the relationship between the PV and SP when the SP value or SP group is changed.

■ Initial output of PID control

Item (Bank)	Display	Contents	Initial value	User level
Initial output of PID control (Setup bank)		-10.0 to +110.0%	0.0% or 50.0%	High function

- When the control method is other than the ON/OFF control (Ctrl≠0), the display and setting can be performed.
- This value is used for the PID control immediately after the operation mode is changed from READY to RUN or the operation mode becomes RUN as the power is turned ON. This value greatly affects the manipulated variable (MV) when the operation mode is changed.
- When the setting of the Heat/Cool control (C26) is changed, the value is automatically set again. When [C26: Heat/Cool control] is changed to “Enabled” (C26=1), the value becomes “50.0%”. On the contrary, when the setting is changed to “Disabled” (C26=0), the value becomes “0.0%”.

■ PID decimal point position

Item (Bank)	Display	Contents	Initial value	User level
PID decimal point position (Setup bank)		0: No decimal point 1: 1 digit after decimal point (Decimal point of integral time and derivative time)	0	High function

- When the control method is other than the ON/OFF control (Ctrl≠0), the display and setting can be performed.
- When this setting is set at “0”, the integral time and derivative time settings become 0 to 9999s.
- When this setting is set at “1”, the integral time and derivative time settings become 0.0 to 999.9s.

Handling Precautions

When the setting of the PID decimal point position is changed, the integral time and derivative time values are divided by 10 (1/10) or multiplied by 10, and the control characteristics may be changed greatly.

After the setting has been changed, always set the integral time and derivative time to an appropriate value again.

For example, if the setting of the PID decimal point position is changed from “0” to “1” with integral time of 120s, the integral time becomes 12.0s.

■ ON/OFF control

The ON/OFF control related items can be set.

Item (Bank)	Display	Contents	Initial value	User level
Differential (for ON/OFF control) (Parameter bank)	<i>dIFF</i>	0 to 9999U	5U	Basic, Standard, High function
ON/OFF control action point offset (Parameter bank)	<i>oFFS</i>	-1999 to +9999U	0U	High function

- [Differential (for ON/OFF control): dIFF] and [ON/OFF control action point offset: oFFS] can be displayed and set when the control method is the ON/OFF control (Ctrl = 0).
- The following Figure shows the operation of the ON/OFF control:

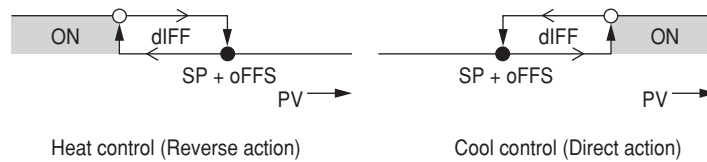

- shows that the ON/OFF is changed at this value.
- shows that the ON/OFF is changed at a point that "1U" is added to this value.

- The following describes examples showing how to use the ON/OFF control action point offset:
 To turn OFF the output at 205°C or more and turn ON the output at less than 190°C with the heat control and SP = 200°C, the differential is set to 15°C and the offset is set to 5°C.
 To turn OFF the output at 5°C or less and turn ON the output at more than 10°C with the cool control and SP = 10°C, the differential is set to 5°C and the offset is set to -5°C.

■ Output variation limit

Variation in the manipulated variable (MV) can be limited.

Item (Bank)	Display	Contents	Initial value	User level
Output variation limit (Parameter bank)	<i>ouTL</i>	0.0: No limit 0.1 to 999.9%	0.0	High

- The upper limit (%) for the absolute value of MV variation can be set in 1s intervals. However, because the sampling cycle is 0.1s, the actual MV variation is limited to 1/10 of the value set. For example, when 5.0(%/s) is set, the variation per 0.1s is limited to ±0.5%. In addition, when 0.1(%/s) is set, the variation per 0.1s is limited to ±0.01%.
- When 0.0 is set, there is no limit on MV variation.
- When the model is a motor drive relay output type with a motor long life mode (C59 = 1), display and setting are not possible because the MV variation limit function operates automatically.

■ PID control

In the fixed PID control, the PID control related items can be set.

Item (Bank)	Display	Contents	Initial value	User level
Proportional band (PID1) (PID bank)	<i>P-1</i>	0.1 to 999.9%	5.0%	Basic, Standard, High function
Integral time (PID1) (PID bank)	<i>I-1</i>	0 to 9999s (No integration control action when set at "0".)	120s	
Derivative time (PID1) (PID bank)	<i>D-1</i>	0 to 9999s (No derivative control action when set at "0".)	30s	
Manual reset (PID1) (PID bank)	<i>rE-1</i>	-10.0 to +110.0%	50.0%	
MV low limit (PID1) (PID bank)	<i>oL-1</i>	-10.0 to +110.0%	0.0%	Standard, High function
MV high limit (PID1) (PID bank)	<i>oH-1</i>	-10.0 to +110.0%	100.0%	
Proportional band for cool side (PID1) (PID bank)	<i>P-1C</i>	0.1 to 999.9%	5.0%	Basic, Standard, High function
Integral time for cool side (PID1) (PID bank)	<i>I-1C</i>	0 to 9999s (No integration control action when set at "0".)	120s	
Derivative time for cool side (PID1) (PID bank)	<i>D-1C</i>	0 to 9999s (No derivative control action when set at "0".)	30s	
Output low limit for cool side (PID1) (PID bank)	<i>oL1C</i>	-10.0 to +110.0%	0.0%	Standard, High function
Output high limit for cool side (PID1) (PID bank)	<i>oH1C</i>	-10.0 to +110.0%	100.0%	
Proportional band (PID 2)	<i>P-2</i>	Same as PID 1	5.0%	Basic, Standard, High function
Integral time (PID 2)	<i>I-2</i>		120s	
Derivative time (PID 2)	<i>D-2</i>		30s	
Manual reset (PID 2)	<i>rE-2</i>		50.0%	
MV low limit (PID 2)	<i>oL-2</i>	Same as PID 1	0.0%	Standard, High function
MV high limit (PID 2)	<i>oH-2</i>		100.0%	
Proportional band for cool side (PID 2)	<i>P-2C</i>	Same as PID 1	5.0%	Basic, Standard, High function
Integral time for cool side (PID 2)	<i>I-2C</i>		120s	
Derivative time for cool side (PID 2)	<i>D-2C</i>		30s	
Output low limit for cool side (PID 2)	<i>oL2C</i>	Same as PID 1	0.0%	Standard, High function
Output high limit for cool side (PID 2)	<i>oH2C</i>		100.0%	
Proportional band (PID 3)	<i>P-3</i>	Same as PID 1	5.0%	Basic, Standard, High function
Integral time (PID 3)	<i>I-3</i>		120s	
Derivative time (PID 3)	<i>D-3</i>		30s	
Manual reset (PID 3)	<i>rE-3</i>		50.0%	

(Note) For presence of the decimal point, when [C23: PID decimal point position] is set at "0", the decimal point does not exist. When this setting is set at "1", the decimal point exists.

(Continue on next page.)

Chapter 5. DETAILED DESCRIPTION OF EACH FUNCTION

Item (Bank)	Display	Contents	Initial value	User level
MV low limit (PID 3)	oL-3	Same as PID 1	0.0%	Standard, High function
MV high limit (PID 3)	oH-3		100.0%	
Proportional band for cool side (PID 3)	P-3C	Same as PID 1	5.0%	Basic, Standard, High function
Integral time for cool side (PID 3)	I-3C		120s	
Derivative time for cool side (PID 3)	d-3C		30s	
Output low limit for cool side (PID 3)	oL3C	Same as PID 1	0.0%	Standard, High function
Output high limit for cool side (PID 3)	oH3C		100.0%	
Proportional band (PID 4)	P-4	Same as PID 1	5.0%	Basic, Standard, High function
Integral time (PID 4)	I-4		120s	
Derivative time (PID 4)	d-4		30s	
Manual reset (PID 4)	rE-4		50.0%	
MV low limit (PID 4)	oL-4	Same as PID 1	0.0%	Standard, High function
MV high limit (PID 4)	oH-4		100.0%	
Proportional band for cool side (PID 4)	P-4C	Same as PID 1	5.0%	Basic, Standard, High function
Integral time for cool side (PID 4)	I-4C		120s	
Derivative time for cool side (PID 4)	d-4C		30s	
Output low limit for cool side (PID 4)	oL4C	Same as PID 1	0.0%	Standard, High function
Output high limit for cool side (PID 4)	oH4C		100.0%	
Proportional band (PID 5)	P-5	Same as PID 1	5.0%	Basic, Standard, High function
Integral time (PID 5)	I-5		120s	
Derivative time (PID 5)	d-5		30s	
Manual reset (PID 5)	rE-5		50.0%	
MV low limit (PID 5)	oL-5	Same as PID 1	0.0%	Standard, High function
MV high limit (PID 5)	oH-5		100.0%	
Proportional band for cool side (PID 5)	P-5C	Same as PID 1	5.0%	Basic, Standard, High function
Integral time for cool side (PID 5)	I-5C		120s	
Derivative time for cool side (PID 5)	d-5C		30s	
Output low limit for cool side (PID 5)	oL5C	Same as PID 1	0.0%	Standard, High function
Output high limit for cool side (PID 5)	oH5C		100.0%	

(Continue on next page.)

Item (Bank)	Display	Contents	Initial value	User level
Proportional band (PID 6)	<i>P-6</i>	Same as PID 1	5.0%	Basic, Standard, High function
Integral time (PID 6)	<i>I-6</i>		120s	
Derivative time (PID 6)	<i>D-6</i>		30s	
Manual reset (PID 6)	<i>rE-6</i>		50.0%	
MV low limit (PID 6)	<i>oL-6</i>	Same as PID 1	0.0%	Standard, High function
MV high limit (PID 6)	<i>oH-6</i>		100.0%	
Proportional band for cool side (PID 6)	<i>P-6C</i>	Same as PID 1	5.0%	Basic, Standard, High function
Integral time for cool side (PID 6)	<i>I-6C</i>		120s	
Derivative time for cool side (PID 6)	<i>D-6C</i>		30s	
Output low limit for cool side (PID 6)	<i>oL6C</i>	Same as PID 1	0.0%	Standard, High function
Output high limit for cool side (PID 6)	<i>oH6C</i>		100.0%	
Proportional band (PID 7)	<i>P-7</i>	Same as PID 1	5.0%	Basic, Standard, High function
Integral time (PID 7)	<i>I-7</i>		120s	
Derivative time (PID 7)	<i>D-7</i>		30s	
Manual reset (PID 7)	<i>rE-7</i>		50.0%	
MV low limit (PID 7)	<i>oL-7</i>	Same as PID 1	0.0%	Standard, High function
MV high limit (PID 7)	<i>oH-7</i>		100.0%	
Proportional band for cool side (PID 7)	<i>P-7C</i>	Same as PID 1	5.0%	Basic, Standard, High function
Integral time for cool side (PID 7)	<i>I-7C</i>		120s	
Derivative time for cool side (PID 7)	<i>D-7C</i>		30s	
Output low limit for cool side (PID 7)	<i>oL7C</i>	Same as PID 1	0.0%	Standard, High function
Output high limit for cool side (PID 7)	<i>oH7C</i>		100.0%	
Proportional band (PID 8)	<i>P-8</i>	Same as PID 1	5.0%	Basic, Standard, High function
Integral time (PID 8)	<i>I-8</i>		120s	
Derivative time (PID 8)	<i>D-8</i>		30s	
Manual reset (PID 8)	<i>rE-8</i>		50.0%	
MV low limit (PID 8)	<i>oL-8</i>	Same as PID 1	0.0%	Standard, High function
MV high limit (PID 8)	<i>oH-8</i>		100.0%	

(Continue on next page.)

Item (Bank)	Display	Contents	Initial value	User level
Proportional band for cool side (PID 8)	P-8C	Same as PID 1	5.0%	Basic, Standard, High function
Integral time for cool side (PID 8)	I-8C		120s	
Derivative time for cool side (PID 8)	D-8C		30s	
Output low limit for cool side (PID 8)	oL8C	Same as PID 1	0.0%	Standard, High function
Output high limit for cool side (PID 8)	oH8C		100.0%	

- When the control method is other than the ON/OFF control (Ctrl ≠ 0), the display and setting can be configured.
- [... for cool side] related items can be displayed and set when [C26: Heat/Cool control] is set to [1: Enabled].
- When the Integral time (I-x) is set at “0s” or Integral time for cool side (I-x.C) is set at “0s” in the Heat/Cool control, no integration control action is performed. The Manual reset (rE-x) can be used in both the heat and cool controls.
- Parameter settings for the cool control are displayed only when the Heat/Cool control is set enabled.
- When the Integral time for heat side or cool side is "0s", the operation is processed with both Integral time for heat side and cool side set at "0s".
- If the setting is made so that the output low limit is greater than the output high limit, the operation is performed with the low limit swapped for the high limit automatically.
- Priorities for PID group change
Priorities for PID group change are shown below.

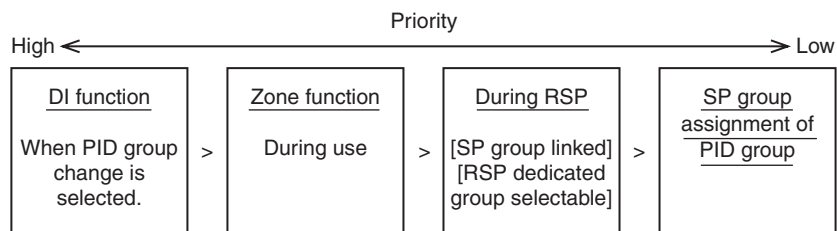

! Handling Precautions

- If PID group change is used for an internal contact (DI), zone PID does not function. When zone PID is used, do not use PID group change by selecting PID group selection as the function of an internal contact (DI).
- The SDC25/26 does not have an RSP (remote SP) function or zone function.

■ Zone PID

In the PID fixed control, the PID group auto change function by the SP or PV can be selected.

Item (Bank)	Display	Contents	Initial value	User level
zone PID operation (Setup bank)		0: Disabled. 1: Changed by SP. 2: Changed by PV.	0	High function
Zone 1 (Zone bank)		-1999 to +9999U	9999U	High function
Zone 2 (Zone bank)			9999U	
Zone 3 (Zone bank)			9999U	
Zone 4 (Zone bank)			9999U	
Zone 5 (Zone bank)			9999U	
Zone 6 (Zone bank)			9999U	
Zone 7 (Zone bank)			9999U	
Zone hysteresis (Zone bank)		0 to 9999U	5U	

- When the PID fixed control (Ctrl=1) is used, the display and setting can be performed.
- When [C24: Zone PID operation] is set at “0: Disabled.”, the PID group setting of the SP bank becomes valid.
- When the zone PID operation is set at “Enabled.” (C24=1 or 2), the PID group setting of the SP bank becomes invalid and the PID group is automatically changed as described in the following. Additionally, a hysteresis can be set so that the PID group is not changed frequently by a small change of the PV or SP at a position close to the zone set value.

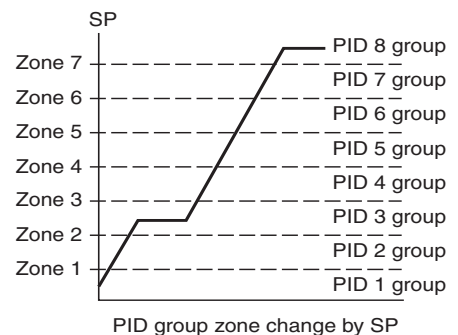
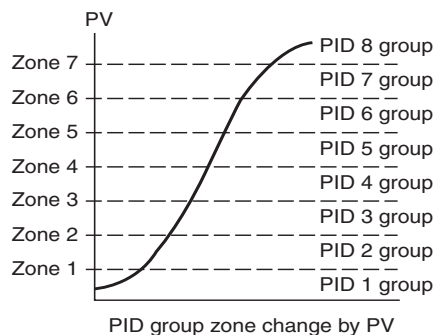

- Operation at a changeover point between zones is as shown below. As an example, the change between PID1 and PID2 is shown.

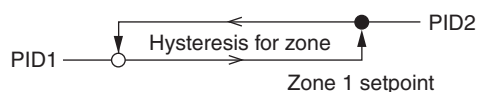

- Shows that the PID group changes at this value.
- Shows that the PID group changes at the point where 1U is added to this value.

■ Heat/Cool control

The Heat/Cool control related items, such as Heat/Cool, Heat/Cool control deadband, and Heat/Cool change point can be set.

However, when the control output type is R1 (motor drive relay output), the Heat/Cool control is not enabled.

Item (Bank)	Display	Contents	Initial value	User level
Heat/Cool (Setup bank)	C 27	0: Normal 1: Energy saving	0	Standard, High function
Heat/Cool control deadband (Setup bank)	C 28	-100.0 to +100.0%	0.0%	Basic, Standard, High function
Heat/Cool change point (Setup bank)	C 29	-10.0 to +110.0%	50.0%	High function

The following shows the Heat/Cool control calculation:

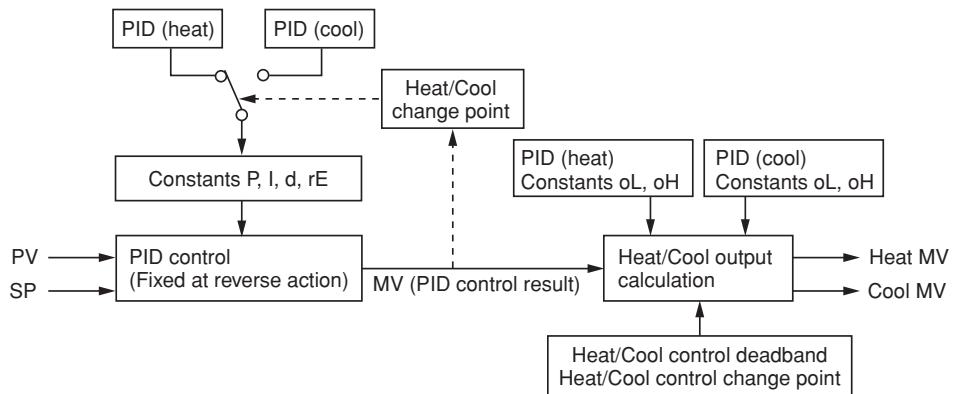

- When [C26: Heat/Cool control] is set to [1: Enabled], the display and setting can be made.
- When $MV \geq 50\%$, the control is changed to the PID (heat).
- When $MV < 50\%$, the control is changed to the PID (cool).
- When [C27: Heat/Cool] is set to [1: Energy saving], the heat/cool change is suppressed to indirectly obtain the energy saving effect. However, when [C28: Heat/Cool control deadband] is less than 0.0%, the energy saving effect cannot be obtained.
- How the relationship between the output (heat) and output (cool) is made for the PID control result (MV) is set.



Note

● Heat/cool output

◆ Formulas and limits for the heat/cool MV

“Deadband” in the explanation below refers to a heat/cool control deadband.

The cool MV and the heat MV are determined by the following formulas and the MV high and low limits.

$$\text{Heat MV} = (MV - \text{heat/cool control change point} - 0.5 \times \text{deadband}) \times \text{change rate}$$

$$\text{Cool MV} = (\text{heat/cool control change point} - MV - 0.5 \times \text{deadband}) \times \text{change rate}$$

$$\text{Change rate} = \frac{100}{\text{Heat/cool control change point} - 0.5 \times \text{deadband}}$$

However, MV high and low limits, output low limit (cooling), and output high limit (cooling) are related to the heat MV and cool MV as follows.

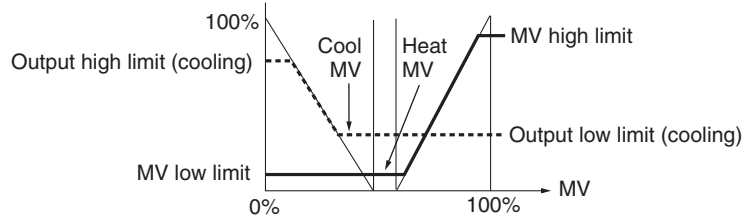

Note: The thick line and thick dotted line represent heat MV and cool MV respectively.

- $MV \text{ low limit} \leq \text{heat MV} \leq MV \text{ high limit}$
- $\text{Output low limit (cooling)} \leq \text{cool MV} \leq \text{output high limit (cooling)}$
- Use the controller within the following range: $0.0 < \text{heat/cool control change point} < 100.0$.
- In the formula for rate of change, do not make the denominator = 0.
- Regardless of the heat/cool control change point setting, 50 % of MV is always the point at which the PID group switches.

◆ Examples of output

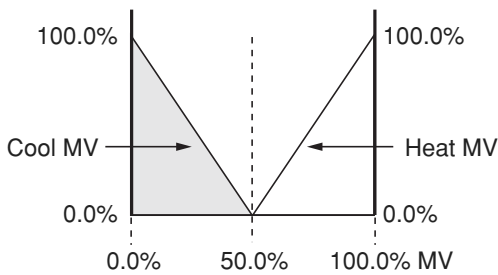

Figure 1.
Deadband = 0.0 %
Heat/cool control change point = 50.0 %

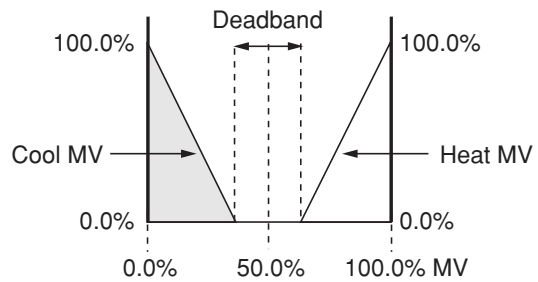

Figure 2.
Deadband > 0.0 %
Heat/cool control change point = 50.0 %

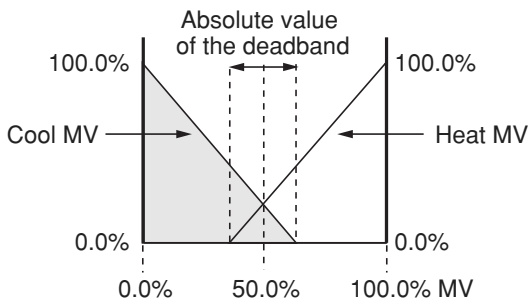

Figure 3.
Deadband < 0.0 %
Heat/cool control change point = 50.0 %

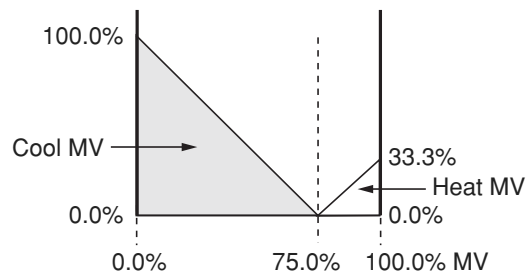

Figure 4.
Deadband = 0.0 %
Heat/cool control change point = 75.0 %

In figure 4, when the MV is 100 %, the heat MV is 33.3 %. In this case, when the heat/cool control change point is 50 % or more, if the MV is 100 %, the heat MV high limit is less than 100 %. The change rate of the heat MV relative to the MV is the same as that of the cool MV relative to the MV.

■ Auto tuning (AT)

The following AT related items can be set:

Item (Bank)	Display	Contents	Initial value	User level
MV low limit at AT (Parameter bank)	At.oL	-10.0 to +110.0%	0.0%	Basic, Standard, High function
MV high limit at AT (Parameter bank)	At.oH	-10.0 to +110.0%	100.0%	
AT type (Extended tuning bank)	At.ty	0: Normal (Standard control characteristics) 1: Immediate response (Control characteristics that respond immediately to external disturbance.) 2: Stability (Control characteristics having less up/down fluctuation of PV)	0	
AT Proportional band adjust (Extended tuning bank)	At-P	0.00 to 99.99	1.00	High function
AT Integral time adjust (Extended tuning bank)	At-I	0.00 to 99.99	1.00	
AT Derivative time adjust (Extended tuning bank)	At-d	0.00 to 99.99	Position proportional control model: 0.00 (Note), Nonposition propor. types: 1.00	

(Note) AT derivative time adjustment coefficient

Since the coefficient on position proportional control models (with code R1 in the control output segment of the model No.) is originally set at 0.00, the derivative time is 0 seconds when AT is complete. To have the AT result affect control, change the setting to 1.00.

- When the control method is other than the ON/OFF control (Ctrl ≠ 0), the display and setting can be configured.
- The manipulated variable (MV) during execution of AT can be limited by the MV low limit at AT (At.oL) and MV high limit at AT (At.oH).
When the Heat/Cool control is not used, the MV becomes a value limited by both the MV low limit at AT (At.oL)/MV high limit at AT (At.oH) and MV low limit (oL-x)/MV high limit (oH-x) of the PID constant.
When the Heat/Cool control is used, the MV becomes a value limited by the MV low limit at AT (At.oL)/MV high limit at AT (At.oH), the heat MV becomes a value limited by the MV low limit (oL-x)/MV high limit (oH-x) of the PID constant, and the cool MV becomes a value limited by the output low limit for cool side (oLx.C)/output high limit for cool side (oHx.C) of the PID constant.
- The AT type (At.ty) is a setting item that the PID constant of the control characteristics suitable for the system is calculated by the AT.
Set value 1 (immediate response) is adjusted to the process that the heater heating directly affects the PV to aim at the adjustment considering the immediate response.
Set value 2 (stability) is adjusted to the process that the heater heating indirectly affects the PV to aim at the adjustment considering the stability.
- If the setting is made so that the MV low limit at AT is greater than MV high limit at AT, the operation is performed with the low limit swapped for the high limit automatically.

 Note

When compared to the AT functions of Azbil Corporation's older models, set value 1 (immediate response) is close to the SDC10 and set value 0 (normal) is close to the SDC20/21 and SDC30/31.

The following figure shows the conceptual diagram expressing differences in control result using the PID constant calculated by each AT type:

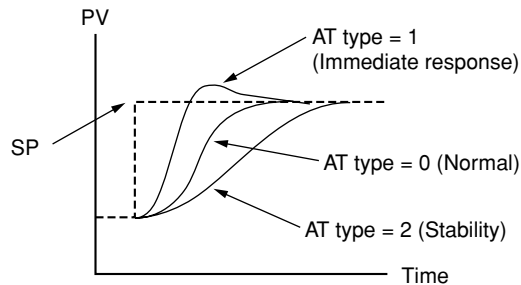

Difference in PV change when SP is changed.

- For the AT Proportional band adjustment (At-P), AT Integral time adjustment (At-I), and AT Derivative time adjustment (At-d), the value that the PID constant calculated by the AT is multiplied by each coefficient is written into the set value of the PID constant. However, the coefficient must be a value in the PID constant setting range.

Note

- In the Heat/Cool control, it is possible to execute the AT only on the heat or cool side.
- Setting that the AT is activated for only the heat PID constant in the Heat/Cool control:
 $50.0\% < MV \text{ low limit at AT (At.oL)} < MV \text{ high limit at AT (At.oH)}$
- Setting that the AT is activated for only the cool PID constant in the Heat/Cool control:
 $MV \text{ low limit at AT (At.oL)} < MV \text{ high limit at AT (At.oH)} < 50.0\%$

For details about AT,

- ☞ ■ Auto turning (AT) stop/start (on page 5-11) and 5-4 Auto Tuning (AT) Function (on page 5-29).

■ **Just-FiTTER**

This Just-FiTTER function provides the effect of the overshoot suppression and the following items can be set:

Item (Bank)	Display	Contents	Initial value	User level
Just-FiTTER overshoot limit/restraint/control coefficient (Extended tuning bank)	<i>JF.ov</i>	0 to 100 ("0": JF function disabled)	0	Standard, High function
Just-FiTTER settling band (Extended tuning bank)	<i>JF.bd</i>	0.00 to 10.00%	0.30%	High function

- When the control method is other than the ON/OFF control (Ctrl ≠ 0), the display and setting can be configured.
- Function of Just-FiTTER overshoot limit/restraint/control coefficient (JF.ov)
When the Just-FiTTER overshoot limit/restraint/control coefficient (JF.ov) is set to "0", the Just-FiTTER function becomes invalid.
When this coefficient is "1" or more, the effect of the overshoot limit/restraint/control becomes larger as the coefficient becomes larger.
- Function of Just-FiTTER settling band (JF.bd)
When the % value of the width of the absolute value deviation to the PV range is larger than the set value, the Just-FiTTER function is started. When this value is smaller than the set value, this is judged as that the PV is settled by the Just-FiTTER function.

■ **RationalLOOP**

This RationalLOOP function suppresses the unstable trend if the immediate response to external disturbance is increased by the high precision control logic. The following items can be set:

Item (Bank)	Display	Contents	Initial value	User level
Control algorithm (Extended tuning bank)	<i>Ctrl.A</i>	0: PID (Conventional PID) 1: RationalLOOP (High-performance PID)	0	Standard, High function

- When the control method is other than the ON/OFF control (Ctrl ≠ 0), the display and setting can be made.

■ **SP lag**

This SP lag function suppresses changes in MV when the SP is changed. The following items can be set:

Item (Bank)	Display	Contents	Initial value	User level
SP lag constant (Extended tuning bank)	<i>SP.Lg</i>	0.0 to 999.9 (No effect when set at "0.0".)	0.0	High function

- When the control method is other than the ON/OFF control (Ctrl ≠ 0), the display and setting can be made.
- Function of SP lag constant (SP.Lg)
When the SP lag constant is set at "0.0", the SP lag function becomes invalid. When this value is "0.1" or more, changes in MV when the SP is changed become smaller and the effect of the overshoot suppression becomes larger as the value becomes larger.

5 - 4 Auto Tuning (AT) Function

The auto tuning (AT) function is used when the PID constants are set automatically with the control method set at “Fixed PID” ([Ctrl = 1]).

The AT function can be used when the control method is set to “Fixed PID”.

■ Starting procedures

- (1) Make sure that the PV input or operation end (heater power, etc.) is controllable.
- (2) Using the [r- -r] setup of the mode bank, multi-status display, and LED monitor, make sure that the operation is in the RUN mode. If the indicator [rdy] is lit and the operation is in the READY mode, change the mode to the RUN mode.
- (3) Make sure that the mode indicator [man] is off and the operation is in the AUTO mode. If the indicator [man] is lit and the operation is in the MANUAL mode, change the mode to the AUTO mode.
- (4) Set the parameter setting [AT Stop/Start] to “AT start ([At] = [At.on])”.

■ Stopping procedures

The AT function is completed automatically. To stop the AT function, which is running, change the parameter setting [AT Stop/Start] to AT stop ([At] = [At.oF]). Additionally, the AT function is stopped when changing the READY mode to the MANUAL mode.

● Display during execution of AT

The decimal point at the 1st digit of the upper display (right end digit) flashes twice repeatedly while the AT function is running. When the AT function is completed and the PID constants are changed, this LED goes off.

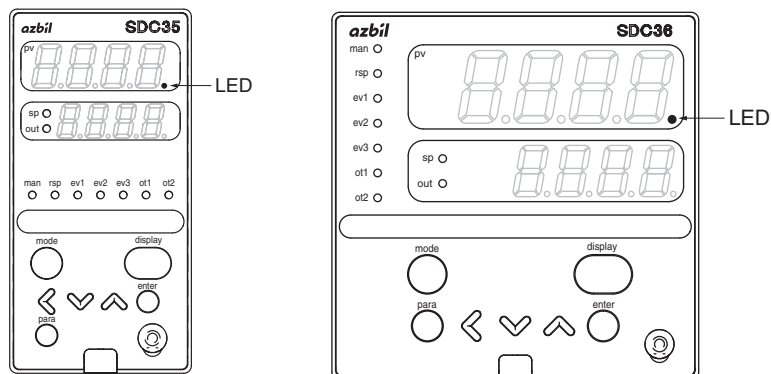

● Operation during execution of AT

The AT function calculates the PID constants using the limit cycle.

- (1) When the AT function is started, a point, where the SP and PV deviations are split to “2:1”, is determined as ON/OFF change point of the manipulated variable (MV).
- (2) When the limit cycle is judged as stable, the PID constants are changed and the AT function is completed.

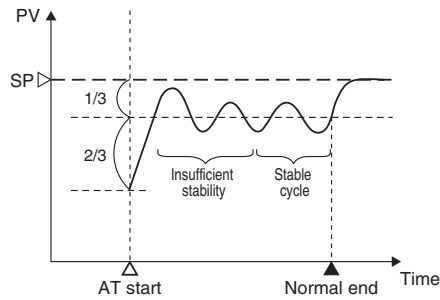

In the Heat/Cool control, the AT function is run in the status that both the heat MV and cool MV are operated.

In the first half, the MV is changed to the MV low limit/MV high limit. In the latter half, the MV is changed in a slightly narrow range.

The following Figure shows an example of the AT execution when the Heat/Cool control deadband is 0.0%, Heat/Cool control change point is 50.0%, MV low limit is 0.0%, and MV high limit is 100.0%:

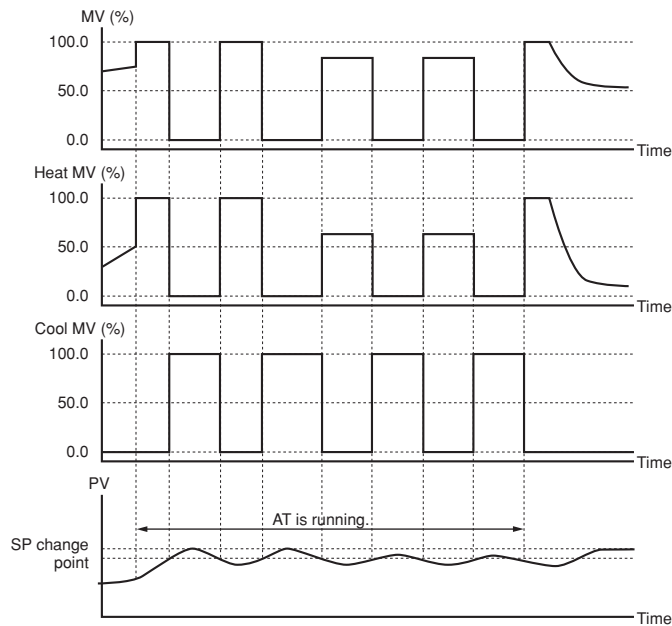

! Handling Precautions

- Before starting the AT function, put the PV input and/or actuator (heater power, etc.) in the controllable status.
- When the control method is set at “ON/OFF control” ([Ctrl] = 0), the AT function cannot be started. To operate the AT function, set the control method to “Fixed PID” ([Ctrl] = 1).
- To start the AT, it is absolutely necessary that the operation is in the READY mode and AUTO mode, and no PV input errors occur.
- If the mode is changed to the READY mode or MANUAL mode or if the PV input error or power failure occurs during execution of the AT function, the AT function is stopped without changing of the PID constants.

- On position proportional control models (with code R1 in the control output segment of the model No.), the factory setting for At-d (AT derivative time adjustment coefficient) in the Extended tuning bank is 0.00, and therefore the derivative time is 0 seconds when AT is complete. To have the AT result affect control, change the At-d setting to 1.00 and re-execute AT. For details,
 - ☞ ■ Auto turning (AT) (on page 5-26).
- When the Heat/Cool control is not used, the MV becomes a value limited by both ranges, one range is between the MV low limit at AT (AT.oL) and MV high limit at AT (AT.oH), and the other is between the MV low limit (oL-x) and MV high limit (oH-x) of the PID constant. When there are no common portions in two ranges, the AT function is stopped automatically.
- When the Heat/Cool control is used, the MV becomes a value limited by the MV low limit at AT (At.oL)/MV high limit at AT (At.oH), the heat MV becomes a value limited by the MV low limit (oL-x)/MV high limit (oH-x) of the PID constant, and the cool MV becomes a value limited by the output low limit for cool side (oLx.C)/output high limit for cool side (oHx.C) of the PID constant.
- When the MV low limit at AT (AT.oL)/high limit (AT.oH), MV low limit (oL-x)/high limit (oH-x), output low limit for cool side (oLx.C)/high limit for cool side (oHx.C) of the PID constant are set unevenly, the PV may not be changed up or down even though the MV is changed by the AT. In this case, the AT is kept continued. Then, stop the AT manually, set the high limit and low limit of the manipulated variable again, and restart the AT.
- The number of limit cycles and period of time from the AT start to AT end may vary depending on the control subject.
- The MV ON and OFF are repeated several times during execution of the AT function to perform the limit cycle. (The OFF operation described here means MV limited by the MV low limit at AT ([At.oL]) or MV high limit at AT ([oL]). The default setting before shipment is “0%”. Additionally, the ON operation described here means MV limited by the MV high limit at AT ([At.oH]) or MV high limit at AT ([oH]). The default setting before shipment is “100%”. If this AT operation does not function correctly, take either of the following measures:
 - (1) Change the MV low limit at AT ([At.oL]) or MV high limit at AT ([At.oH]) to an appropriate value, and then start the AT function.
 - (2) Set the PID constants manually without use of AT.
- The AT progress value can be seen in the operation display mode. For details,
 - ☞ ■ Operation displays in section 6-1, List of Operation Displays (on page 6-1).

When the Heat/Cool control is not used, the AT progress value decrements from [4] during execution of the AT function and becomes [0] at completion of the AT function.

When the Heat/Cool control is used, the AT progress value decrements from [8] during execution of the AT function and becomes [0] at completion of the AT function.

In both cases, the AT progress value may be “1” or “0” when the AT process is in the transient status.
- Appropriate PID constants cannot be obtained depending on the control subject. If this happens, set the PID constants manually.
- The MV ON/OFF change point determined when the AT function is started does not change even though the SP is changed while the AT is running. For details about AT function,
 - ☞ ■ Auto turning (AT) Stop/Start (on page 5-11) and ■ Auto turning (AT) (on page 5-26).

5 - 5 Set Point (SP)

The following shows the functional block diagram of the SP. For details about step operation,  5-6, Step operation.

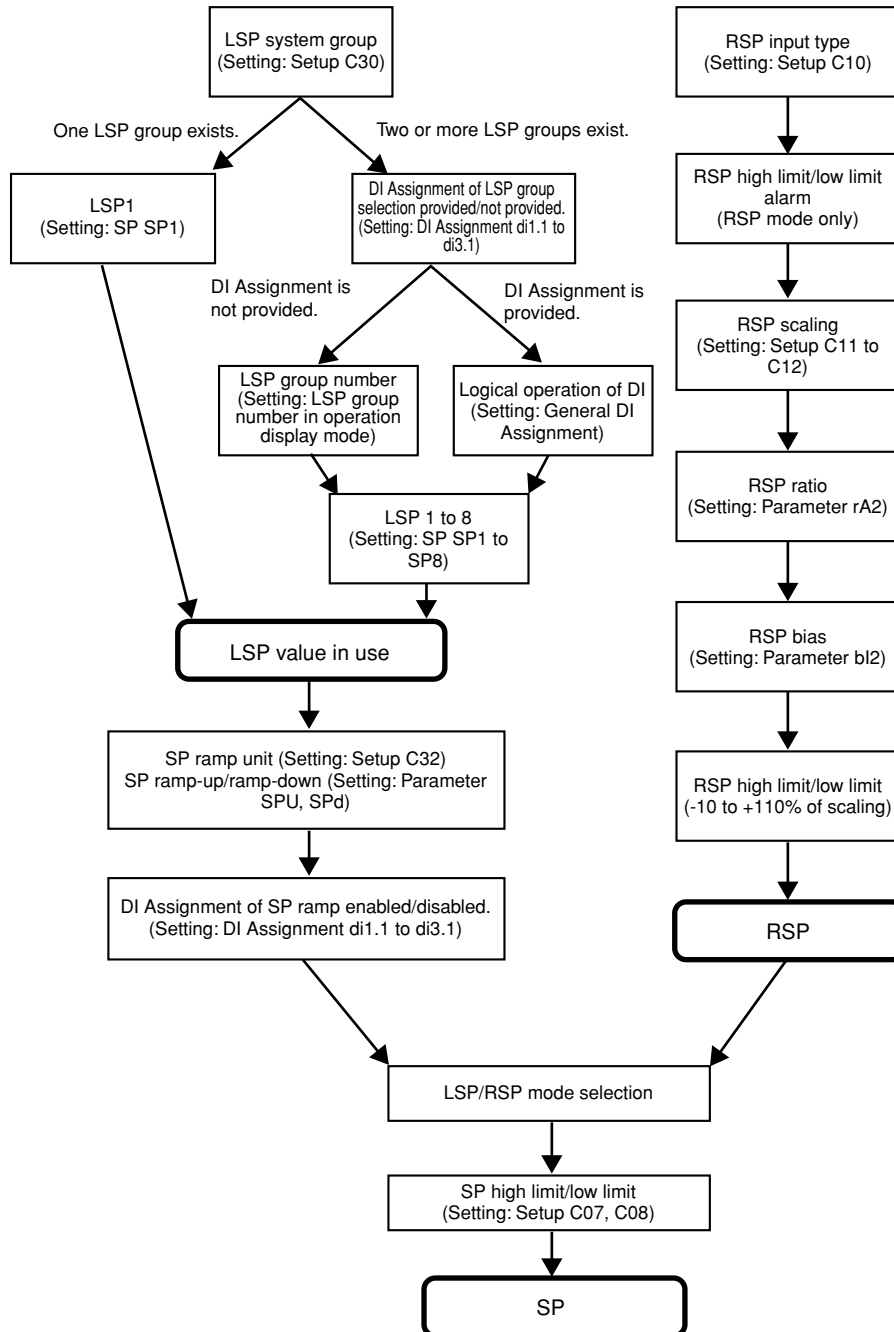

Note

LSP is a local SP and shows that the data is retained inside this unit.

On the contrary, SP by the analog input from the outside is called RSP or remote SP.

■ SP setup in operation display mode

The set value for LSP in use of LSP1 to 8 can be set.

The LSP set value is different from the SP display value during SP ramp.

However, the set value is displayed while the key is being operated to change the setting.

Item (Bank)	Display	Contents	Initial value	User level
SP (Operation display)	PV is shown on the upper display.	SP low limit to SP high limit U	0 U	Basic, Standard, High function

- When [bit 1: SP display] of [C74: PV/SP display setup] is set at "1" (display is provided), the display and setting can be made.
- The SP cannot be set in the RSP mode.

■ LSP system group

The LSP system group can be selected.

Item (Bank)	Display	Contents	Initial value	User level
LSP system group (Setup bank)	 30	1 to 8	1	Basic, Standard, High function

■ SP ramp type

Either the standard ramp or multi-ramp can be selected.

Additionally, for details about step operation,

 5-6, Step operation (on page 5-43).

Item (Bank)	Display	Contents	Initial value	User level
SP ramp type (Setup bank)	 31	1: Multi-ramp 2: Step operation The step operation is stopped when the power is turned ON again (READY). 3: Step operation The step operation is recovered when the power is turned ON again.	0	High function

- When this setting is set at "0", the ramp-up and ramp-down use only one setting group (SP ramp-up and SP ramp-down of parameter bank) even though one LSP group or multiple LSP groups are used.
- When this setting is set at "1", the ramp setting (ramp 1 to 8 of SP bank) common to the up/down to be set by LSP group is used.

■ RSP input type

The RSP input signal type can be selected.

Item (Bank)	Display	Contents	Initial value	User level
RSP input type (Setup bank)	 10	0: 4 to 20mA 1: 0 to 20mA 2: 0 to 5V 3: 1 to 5V 4: 0 to 10V	0	Basic, Standard, High function

- When the model provides the RSP input, the display and setting can be performed.

■ RSP input range low limit/high limit

The scaling of the RSP input can be set.

Item (Bank)	Display	Contents	Initial value	User level
RSP input range low limit (Setup bank)		-1999 to +9999 (No decimal point) -199.9 to +999.9 (1 digit after the decimal point) -19.99 to +99.99 (2 digits after the decimal point)	0U	Basic, Standard, High function
RSP input range high limit (Setup bank)		-1.999 to +9.999 (3 digits after the decimal point) The decimal point position is the same as that of the PV.	1000U	

- When the model provides the RSP input, the display and setting can be performed.
- The following shows the relationship between the RSP input and RSP based on the range low limit and high limit settings.

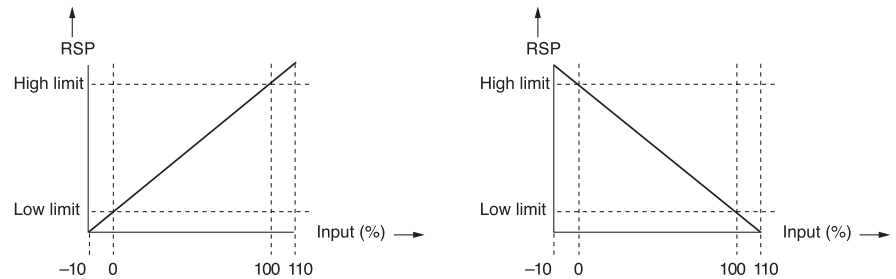

■ RSP ratio and RSP bias

The RSP ratio and RSP bias can be set to correct the RSP.

Item (Bank)	Display	Contents	Initial value	User level
RSP ratio (Parameter bank)		0.001 to 9.999	1.000	Standard, High function
RSP bias (Parameter bank)		-1999 to +9999U	0U	

- When the model provides the RSP input, the display and setting can be performed.
- Details of RSP ratio and RSP bias calculation
Assuming that the calculation input is RSP_{in} , the calculation result is RSP_{out} , the RSP ratio is RA2, and the RSP bias is BI2, the following calculation formula is obtained.

$$RSP_{out} = (RSP_{in} \times RA2) + BI2$$

■ RSP filter

This RSP filter is a primary delay filter to be used if the RSP deflects finely due to effect of the noise. As this set value is made larger, the RSP to be used for control of this unit becomes difficult to change. Normally, the RSP filter is used with the initial value (0.0).

Item (Bank)	Display	Contents	Initial value	User level
RSP filter (Parameter bank)	<i>FL2</i>	0.0 to 120.0	0.0	Standard, High function

- When the model provides the RSP input, the display and setting can be performed.

$$OUT = OUT_{-1} + (IN - OUT_{-1}) / (T / Ts + 1)$$

- IN: Input to the filter
- OUT: Current filter calculation output
- OUT₋₁: Previous filter calculation output
- T: Filter set value (second)
- Ts: Sampling cycle time (0.1s)

■ RSP low limit/high limit and RSP low limit/high limit alarms

The RSP low limit and RSP high limit are provided for each RSP input type. Basically, -10%FS of each range is the RSP low limit and +110%FS of each range is the RSP high limit.

For details,

- ☞ ■ Behavior in case of RSP input failure (on page 10-4).

The RSP is limited so that it is in a range from the RSP low limit to the RSP high limit. If the RSP before the RSP ratio, RSP bias, and RSP filter are activated is larger than the RSP high limit in the RSP mode, the RSP high limit alarm (AL05) occurs. If this RSP is smaller than the RSP low limit, the RSP low limit alarm (AL06) occurs. (Both the RSP high limit alarm and RSP low limit alarm do not occur in the LSP mode.) When the RSP is used as SP in the RSP mode, the limiting with the SP low limit and SP high limit also becomes valid.

■ RSP and LSP1 to 8

The RSP display and eight groups of LSP setup values can be set.

Item (Bank)	Display	Contents	Initial value	User level
RSP (SP bank)	<i>rSP</i>	RSP (Remote SP) Setting disabled.	—	Basic, Standard, High function
LSP (SP bank)	<i>SP-1</i>	SP low limit to SP high limit	0U	
	<i>SP-2</i>		0U	
	<i>SP-3</i>		0U	
	<i>SP-4</i>		0U	
	<i>SP-5</i>		0U	
	<i>SP-6</i>		0U	
	<i>SP-7</i>		0U	
	<i>SP-8</i>		0U	

- When the model provides the RSP input, the RSP can be displayed and set.
- The display and setting can be made for the LSP system group selected in [C30: LSP system group].

■ PID group number

The PID group numbers to the RSP and eight groups of LSPs can be set.

Item (Bank)	Display	Contents	Initial value	User level
PID group number (RSP) (SP bank)	<i>P1 d.r</i>	1 to 8	1	Standard, High function
PID group number (LSP) (SP bank)	<i>P1 d.1</i>		1	
	<i>P1 d.2</i>		1	
	<i>P1 d.3</i>		1	
	<i>P1 d.4</i>		1	
	<i>P1 d.5</i>		1	
	<i>P1 d.6</i>		1	
	<i>P1 d.7</i>		1	
	<i>P1 d.8</i>		1	

- When the model provides the RSP input, the PID group number (RSP) can be displayed and set.
- The PID group numbers (LSP) for the LSP system groups selected in [C30: LSP system group] can be displayed and set.

■ LSP group number

The LSP group number can be set.

Item (Bank)	Display	Contents	Initial value	User level
LSP group number (Operation display)	<i>LSP</i>	Numeric value at the rightmost digit of the display. 1 to LSP system group	1	Basic, Standard, High function

- When [C30: LSP system group] is set at “2” or more and [bit 2: LSP group number display] of the PV/SP display setup (setup C74) is set at “1” (display is provided), the display can be made.
- When the display is possible and the DI Assignment of the LSP group selection is not performed, the setting can be made.

■ DI Assignment of LSP group selection

The LSP group selection can be set for internal contacts 1 to 5 using the DI Assignment.

Item (Bank)	Display	Contents	Initial value	User level
DI Assignment Internal Contacts 1 to 5 Operation type (DI Assignment bank)	di 1.1	0: No function 1: LSP group selection (0/+1) 2: LSP group selection (0/+2) 3: LSP group selection (0/+4) 4 to 20: Other functions	0	Basic, Standard, High function
	di 2.1		0	
	di 3.1		0	
	di 4.1		0	
	di 5.1		0	

- Details of LSP group selection with the internal contact function

The following shows the LSP group selection value according to the ON/OFF status of each internal contact:

LSP group selection (0/+1) OFF: 0 ON: 1

LSP group selection (0/+2) OFF: 0 ON: 2

LSP group selection (0/+4) OFF: 0 ON: 4

The value, that "1" is added to the sum of the LSP group selection values according to the ON/OFF status of each internal contact, becomes the LSP group number.

For example, when the sum of LSP group selection values of internal contact 1 to 5 is "1", the LSP group number becomes "2". However, if this value exceeds the value set in [C30: LSP system group], LSP groups, the number of which is the same as the value set in [C30: LSP system group], are selected.

- Even though the LSP system group is "1", the display and setting can be made, but the LSP group selection with the internal contact function becomes invalid.

■ SP ramp unit

The unit of the SP ramp-up/ramp-down can be set.

Item (Bank)	Display	Contents	Initial value	User level
SP ramp unit (Setup bank)		0: 0.1U/s 1: 0.1U/min 2: 0.1U/h	0	High function

- "0.1U" shows that the decimal point position is shifted one digit rightward as compared with the PV.

Example: When the thermocouple input is in a range of -200 to +1200°C, "0.1U" is "0.1°C".

Example: When the DC voltage input is in a range of 0.0 to 100.0, "0.1U" is "0.01". For the relationship between the decimal point position and the type of PV input range, refer to the next section, "■ SP ramp-up / ramp-down."

! Handling Precautions

When using the DC voltage/DC current input with setting of 3 digits after the decimal point, "0.1U" is "0.0001".

However, the SP ramp-up/SP ramp-down setting cannot display 4 digits together with the decimal point, so the value is displayed without the decimal point.

■ SP ramp-up/ramp-down

The SP ramp-up and ramp-down can be set.

Item (Bank)	Display	Contents	Initial value	User level
SP ramp-up (Parameter bank)		0.0U: No ramp 0.1 to 999.9U (The unit of the ramp time is selected using the SP ramp unit.)	0.0U	High function
SP ramp-down (Parameter bank)			0.0U	

- The SP ramp-up/ramp-down setting is valid when [C31: SP ramp type] is set at "0: Standard".
- When an initial value of "0.0U" is set, the SP ramp function does not function. Therefore, when the ramp-up setting is set to "0.1U" or more and the ramp-down is set to "0.0U", the SP ramp function is enabled only during the ramp-up and disabled during the ramp-down. Additionally, the reverse operation can also be set so that the SP ramp function is enabled only during the ramp-down and disabled during the ramp-up.
- Regarding the setting for the number of digits after the decimal point (C04), the SP ramp display shows one digit more than is shown for the PV. For linear input, if C04 is set for 3 digits after the decimal point, no decimal point is displayed in the SP ramp value, but all 4 displayed digits are after the decimal point. The unit for the SP ramp can be selected from every second, every minute, and every hour in C32 of the SETUP bank. The table below shows how the decimal point position varies depending on the PV input range.

C01 (PV input range type)	C04 (Decimal point position)	SPU (SP ramp up)	SPD (SP ramp down)
2 (0 to 1200°C)	Setting disabled	0.0 to 999.9	0.0 to 999.9
3 (0.0 to 800.0C)	0 (No decimal point)	0.0 to 999.9	0.0 to 999.9
	1 (1 digit after the decimal point)	0.00 to 99.99	0.00 to 99.99
88 (0 to 10V)	0 (No decimal point)	0.0 to 999.9	0.0 to 999.9
	1 (1 digit after the decimal point)	0.00 to 99.99	0.00 to 99.99
	2 (2 digits after the decimal point)	0.000 to 9.999	0.000 to 9.999
	3 (3 digits after the decimal point)	0.0000 to 0.9999	0.0000 to 0.9999

This program is written in C++. Microsoft's Visual C++ 2008 can be used to compile it.

The program is supplied for purposes of reference to assist the user in making a program, and its operation is not 100% guaranteed.

You can download Visual C++ 2008 Express Edition from the Microsoft website at <http://www.microsoft.com/express/>.

- The ramp is started assuming that the current PV value is used as start point when the SP ramp-up or ramp-down is possible under the following conditions.

The power is turned ON.

READY+AUTO status is changed to RUN+AUTO status.

RUN+MANUAL status is changed to RUN+AUTO status.

The AT function is completed (both normal end and forced stop).

Example: (1) When READY is changed to RUN with SP=100°C, PV =25°C, SPU=0.0, and SPd=1.0, the PV is not started.

(2) When READY is changed to RUN with SP=50°C, PV=100°C, SPU=0.0, and SPd=1.0, the PV is started.

- The SP ramp does not function for remote SP.

Handling Precautions



Before changing the slope of the SP ramp, make sure that SP ramping is not in progress.

If the setting is changed while SP ramping is in progress, the SP may change suddenly.

■ SP multi-ramp

The SP multi-ramp set values can be set for eight groups of LSPs.

Item (Bank)	Display	Contents	Initial value	User level
Ramp (SP bank)	rāP.1	0.0U: No ramp. 0.1 to 999.9U (The time unit of the ramp is selected using the SP ramp unit.)	0.0U	Standard, High function
	rāP.2		0.0U	
	rāP.3		0.0U	
	rāP.4		0.0U	
	rāP.5		0.0U	
	rāP.6		0.0U	
	rāP.7		0.0U	
	rāP.8		0.0U	

- When [C31: SP ramp type] is set at “1: Multi-ramp”, the display and setting can be performed.
- In the standard ramp, the ramp-up and ramp-down are set individually. However, in the multi-ramp, the ramp common to the up and down is set.
- When this setting is set at “0.0U”, the SP ramp does not function.
- “rmp.1” corresponds to LSP1 while “rmp.8” corresponds to LSP8.
- “0.1U” shows that the decimal point position is shifted one digit right from the decimal point position of the PV.
For example,
 ■ SP ramp-up/ramp-down (on page 5-38 to 5-39).
- For details about conditions to start the ramp assuming that the current PV value is used as start point,
 ■ SP ramp-up/ramp-down (on page 5-38 to 5-39).

Handling Precautions

Before changing the slope of the SP ramp for the selected LSP No. when the multi-ramp is selected, make sure that SP ramping is not in progress.

If the setting is changed while SP ramping is in progress, the SP may change suddenly.

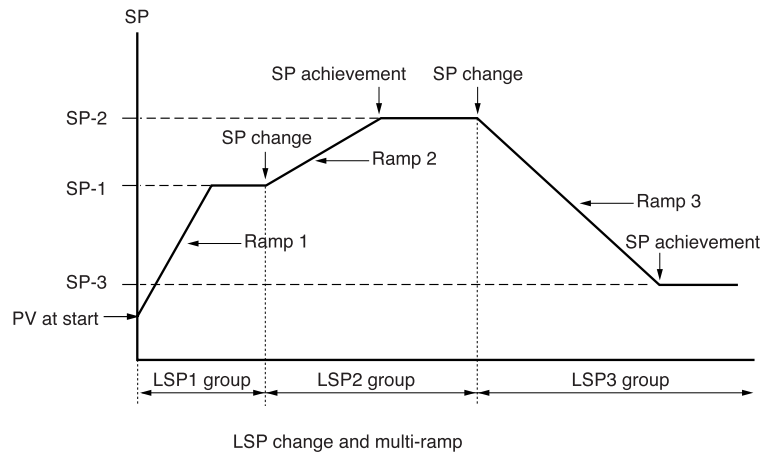

 **Note**

The multi-ramp function is applicable to an application that changes the SP change timing using the external switch or communication when performing the pattern operation as shown above.

To set the SP value hold time,

 5-6 Step Operation (on page 5-43).

■ **SP low limit/high limit**

The SP low limit and high limit can be set to limit the SP range.

Item (Bank)	Display	Contents	Initial value	User level
SP low limit (Setup bank)	C 07	PV input range low limit to PV input range high limit	PV input range low limit	Standard, High function
SP high limit (Setup bank)	C 08	PV input range low limit to PV input range high limit	PV input range high limit	Standard, High function

- If the setting is made so that the SP low limit is greater than the SP high limit, the operation is performed with the low limit swapped for the high limit automatically.

❗ Handling Precautions

When [C01: PV input range type] is set, the SP low limit and high limit are initialized.

■ **DI Assignment of SP ramp enabled/disabled**

The SP ramp enabled/disabled can be set for the internal contact function using the DI assignment.

Item (Bank)	Display	Contents	Initial value	User level
DI Assignment Internal Contacts 1 to 5 Operation type (DI Assignment bank)	d1 1.1	0: No function 13: SP ramp enabled/disabled. 1 to 12, 14 to 20: Other functions	0	Basic, Standard, High function
	d1 2.1		0	
	d1 3.1		0	
	d1 4.1		0	
	d1 5.1		0	

- Details of SP ramp enabled/disabled with internal contact function
The following shows the SP ramp enabled/disabled setting with the internal contact ON/OFF:
OFF: SP ramp enabled. ON: SP ramp disabled.
The SP ramp enabled/disabled is set for only one internal contact.
- When the SP ramp is set disabled, the SP ramp operation is stopped and the SP value becomes the final SP.

5 - 6 Step Operation

Use of up to eight SP groups makes it possible to perform the step operation, in which the SP is changed, as shown in the Figure below.

The step operation is set according to the LSP, ramp, and time of each step.

Additionally, the PID group No. to be used for each step can also be set.

In the step, the portion where the SP has the ramp is called “RAMP” and the portion where the SP is the constant value is called “SOAK”.

(The following Figure shows the RAMP and SOAK portions of step 5.)

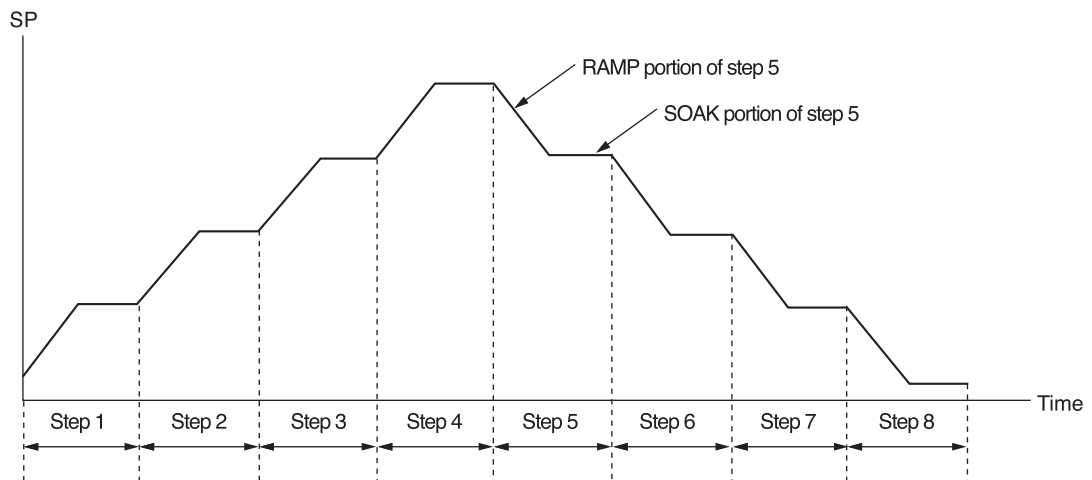

! Handling Precautions

- The step operation functions in the RUN mode. In the READY mode, the operation is stopped at the top of step 1.

■ LSP system group

The number of steps for the step operation can be determined using the LSP system group.

Item (Bank)	Display	Contents	Initial value	User level
LSP system group (Setup bank)		1 to 8	1	Basic, Standard, High function

■ SP ramp type

Whether or not the step operation is performed can be selected. Additionally, the operation when the power is returned after a power cut occurrence during step operation can also be selected.

Item (Bank)	Display	Contents	Initial value	User level
SP ramp type (Setup bank)		0: Standard 1: Multi-ramp 2: Step operation The step operation is stopped when the power restarts (READY). 3: Step operation The step operation is recovered when the power restarts.	0	High function

- To make the step operation enabled, “2” or “3” is set.
- In case of set at “2”, the operation is stopped (READY mode) and returned to the top of the step when the power is returned after the power cut occurs while the step operation is running (RUN mode).
- In case of set at “3”, the operation is restarted from the step before a power cut occurs when the power is returned after the power cut occurs while the step operation is running (RUN mode). However, the SP and time before the power cut cannot be returned completely and the step operation is restarted as described in the following:

If the operation before the power cut is SOAK, the operation is restarted from the beginning of the SOAK portion. If the operation before the power cut is RAMP and the PV alarm (AL01/02) does not occur, the RAMP operation is restarted from the SP same as PV. If the operation before the power cut is RAMP and the PV alarm (AL01/02) occurs, the operation moved to the SOAK portion next to the RAMP.

! Handling Precautions

- The operation of this unit with the setting set at “3” (step operation, operation is recovered when the power restarts) is different from that of Azbil Corporation’s digital programmable controller model DCP-series (DCP31/32, DCP551/552). The DCP-series functions so that the SP, RAMP, or SOAK elapse time immediately before the power cut continues even after the power has been turned ON again. However, this unit functions so that the operation is returned to the start point of the RAMP or SOAK portions, which has been operated immediately before the power cut has occurred.
- When the setting is set at “3” (step operation, operation is recovered when the power restarts), it is also necessary to carefully check the number of EEPROM (nonvolatile memory) writing cycles. When the operation step proceeds in the RUN mode, the data is written into the EEPROM (nonvolatile memory) every time the RAMP or SOAK is changed. If the step operation is continued with a RAMP or SOAK operation time of 10min or less, the erase/write cycles of EEPROM may exceed its service life (approximately 100,000 cycles) within two years. Therefore, do not attempt to operate the unit in such manner.
- When the SP ramp type is set at “standard” or “multi-ramp” (C31 = 0, 1) and the operation mode is the RUN mode, the operation mode is automatically changed to the READY mode if the SP ramp type is changed to “step operation” (C31 = 2, 3).
- When the step operation is set enabled, the LSP mode is fixed and the LSP/RSP selection cannot be performed.

■ SP ramp unit

The ramp unit for the RAMP portion of the step operation can be set.

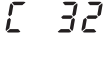
Item (Bank)	Display	Contents	Initial value	User level
SP ramp unit (Setup bank)		0: 0.1U/s 1: 0.1U/min 2: 0.1U/h	1	High function

- "0.1U" shows that the decimal point position is shifted one digit right from the decimal point position of the PV.

Example: When the thermocouple input is in a range of -200 to $+1200^{\circ}\text{C}$, "0.1U" is equal to 0.1°C .

Example: When the DC voltage input is in a range of 0.0 to 100.0 , "0.1U" is equal to "0.01V".

⚠ Handling Precautions

When the DC voltage or DC current input is used with the setting, three digits after the decimal point, "0.1U" is equal to "0.0001".

However, since the SP ramp-up or SP ramp-down setting cannot show four digits after the decimal point, the setting is shown without the decimal point.

■ STEP time unit

The time unit for the SOAK portion of the step operation can be set.

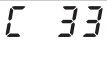
Item (Bank)	Display	Contents	Initial value	User level
STEP time unit (Setup bank)		0: 0.1s 1: 1s ("min. s" on the operation display) 2: 1min ("h. min" on the operation display)	0	High function

- When this setting is set at "0", the time setting unit of the SP bank becomes "0.1s".
- When this setting is set at "1", the time setting unit of the SP bank becomes "s". The decimal point is shown between "min" (2 digits) and "s" (2 digits) of the step remain time on the operation display.
- When this setting is set at "2", the time setting unit of the SP bank becomes "min". The decimal point is shown between "h" (2 digits) and "min" (2 digits) of the step remain time on the operation display.

⚠ Handling Precautions

- In the operation display mode, the step remaining time display follows the step operation time unit setting regardless of the RAMP and SOAK portions.
- If "1" is set, when the step remaining time is 99 minutes 59 seconds or more, the operation display shows 99.99.
- If "2" is set, when the step remaining time is 99 hours 59 minutes or more, the operation display shows 99.99.

■ STEP PV start

Whether or not the PV start exists and its type at start of the step operation can be set.

Item (Bank)	Display	Contents	Initial value	User level
STEP PV start (Setup bank)		0: None 1: Up start 2: Down start	0	High function

- When this setting is set at “0”, the step operation is started from the SOAK portion of step 1.
- When this setting is set at “1”, the step operation is started from the same SP as PV in the up RAMP portion of step 1 if $PV < SP-1$. If $PV \geq SP-1$, the step operation is started from the SOAK portion of step 1.
- When this setting is set at “2”, the step operation is started from the same SP as PV in the down RAMP portion of step 1 if $PV > SP-1$. If $PV \leq SP-1$, the step operation is started from the SOAK portion of step 1.

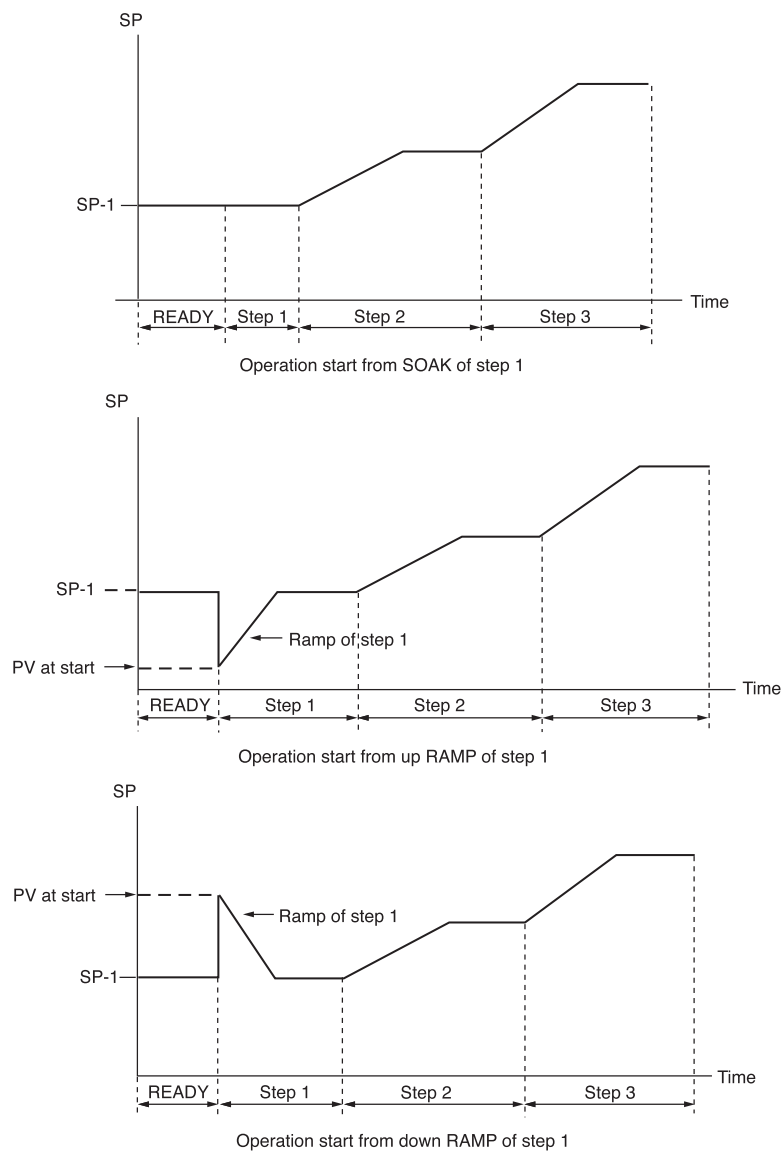

■ STEP loop

Whether or not the loop exists at the end of the step operation and the operation end status can be set.

Item (Bank)	Display	Contents	Initial value	User level
STEP loop (Setup bank)		0: Stop (No loop) 1: Loop 2: Final step continued. (No loop)	0	High function

- When this setting is set at “0”, the operation is stopped (READY mode) if the operation of the SOAK portion of the final step is completed.
- When this setting is set at “1”, the operation is returned to the RAMP portion of step 1 if the operation of the SOAK portion of the final step is completed. At this time, the RAMP operation is performed from SP to SP-1 of the final step regardless of the setting of [C34: STEP PV start]. Since the number of loop cycles is not limited, the loop operation is continued until the READY mode is selected.
- When this setting is set at “2”, the operation is continued with SP of the final step kept remained until the READY mode is selected if the SOAK portion of the final step is completed.

■ STEP operation LSP, PID group No., ramp, time

The SP change and PID group No. by step of the step operation can be set.

Item (Bank)	Display	Contents	Initial value	User level
LSP1 (Step 1) (SP bank)	SP-1	SP low limit (C07) to SP high limit (C08)	0	Basic, Standard, High function
PID group No. (Step 1) (SP bank)	PI d.1	1 to 8	1	
Ramp (Step 1) (SP bank)	ramp.1	0.0U: No ramp. 0.1 to 999.9U (The time unit of the ramp is selected in the SP ramp unit.)	0.0	
Time (Step 1) (SP bank)	t 1n.1	0.0 to 999.9s (The time unit of the step operation is set at "0.1s".) 0 to 9999s (The time unit of the step operation is set at "1s".) 0 to 9999 min (The time unit of the step operation is set at "1min".)	0.0	
LSP (Step 2) (SP bank)	SP-2	Same as step 1.	0	Basic, Standard, High function
PID group No. (Step 2) (SP bank)	PI d.2		1	
Ramp (Step 2) (SP bank)	ramp.2		0.0	
Time (Step 2) (SP bank)	t 1n.2		0.0	
LSP (Step 3) (SP bank)	SP-3	Same as step 1.	0	Basic, Standard, High function
PID group No. (Step 3) (SP bank)	PI d.3		1	
Ramp (Step 3) (SP bank)	ramp.3		0.0	
Time (Step 3) (SP bank)	t 1n.3		0.0	
LSP (Step 4) (SP bank)	SP-4	Same as step 1.	0	Basic, Standard, High function
PID group No. (Step 4) (SP bank)	PI d.4		1	
Ramp (Step 4) (SP bank)	ramp.4		0.0	
Time (Step 4) (SP bank)	t 1n.4		0.0	

(Continue on next page.)

Item (Bank)	Display	Contents	Initial value	User level
LSP (Step 5) (SP bank)	SP-5	Same as step 1.	0	Basic, Standard, High function
PID group No. (Step 5) (SP bank)	PI d.5		1	
Ramp (Step 5) (SP bank)	r nP.5		0.0	
Time (Step 5) (SP bank)	t 1n.5		0.0	
LSP (Step 6) (SP bank)	SP-6	Same as step 1.	0	Basic, Standard, High function
PID group No. (Step 6) (SP bank)	PI d.6		1	
Ramp (Step 6) (SP bank)	r nP.6		0.0	
Time (Step 6) (SP bank)	t 1n.6		0.0	
LSP (Step 7) (SP bank)	SP-7	Same as step 1.	0	Basic, Standard, High function
PID group No. (Step 7) (SP bank)	PI d.7		1	
Ramp (Step 7) (SP bank)	r nP.7		0.0	
Time (Step 7) (SP bank)	t 1n.7		0.0	
LSP (Step 8) (SP bank)	SP-8	Same as step 1.	0	Basic, Standard, High function
PID group No. (Step 8) (SP bank)	PI d.8		1	
Ramp (Step 8) (SP bank)	r nP.8		0.0	
Time (Step 8) (SP bank)	t 1n.8		0.0	

- The display and setting for the number of steps set in [C30: LSP system group] can be performed.
- The PID group No. cannot be displayed and set if the ON/OFF control is used, if the PID group selection is set for the operation type of internal contact 1 to 5, or if the zone PID function is used.
- “0.1U” of the ramp shows that the decimal point position is shifted one digit right from the decimal point position of the PV.
- When the ramp is set at “0.0U”, the operation skips the RAMP and moves to the next SOAK. Additionally, when the LSPs of two continuous steps are the same, the operation skips the RAMP and moves to the next SOAK.
- When the time setting is set at “0.0” or “0”, the operation skips the SOAK and moves to the next RAMP.

[!] Handling Precautions

Before changing the slope of the step ramp during the step operation, make sure that SP ramping is not in progress (in the SOAK portion). If the setting is changed while SP ramping is in progress, the SP may change suddenly.
Also, if the setting is changed during step hold status, the SP may change suddenly.

■ Operation type of internal contact

The following shows the operation types related to the step operation.

 **Note**

For details about internal contact function,
 5-7 Digital Input (DI) and Internal Contact (on page 5-51).

Item (Bank)	Display	Contents	Initial value	User level
Operation type of internal contact 1 (DI assignment bank)	di 1.1	0 to 20 0: No function. 7: RUN/READY mode selection 19: Advance operation 20: Step hold (1 to 6 and 8 to 18 are functions, which do not directly relate to the step operation.)	0	Basic, Standard, High function
Operation type of internal contact 2 (DI assignment bank)	di 2.1		0	
Operation type of internal contact 3 (DI assignment bank)	di 3.1		0	
Operation type of internal contact 4 (DI assignment bank)	di 4.1		0	
Operation type of internal contact 5 (DI assignment bank)	di 5.1		0	

- When this setting is set at “7”, the operation mode is changed to the READY mode if the internal contact is changed from OFF to ON, and the operation mode is changed to the RUN mode if the internal contact is changed from ON to OFF.
- When this setting is set at “19”, the SOAK is moved to the top of the next RAMP or the RAMP is moved to the next RAMP if the internal contact is changed from OFF to ON in the RUN mode. This operation is called “advance”.
 When the advance operation is performed in the SOAK of the final step, the operation mode is changed to the READY mode, the operation is moved to the top of the RAMP of step 1 by loop, or the SOAK is continued according to the setting of [C35: Step operation loop].
- When this setting is set at “20”, the progress of the step operation is stopped if the internal contact becomes ON in the RUN mode. This operation status is called “step hold status”. When the advance operation is performed in the step hold status, the operation enters the step hold status at the top of the next RAMP or SOAK.

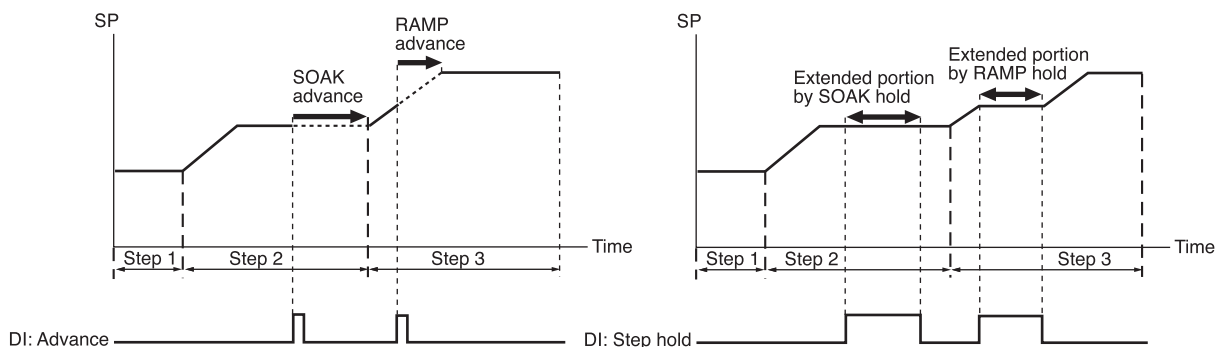

5 - 7 Digital Input (DI) and Internal Contact

The following shows the functional block diagram of the digital input (DI) and internal contact:

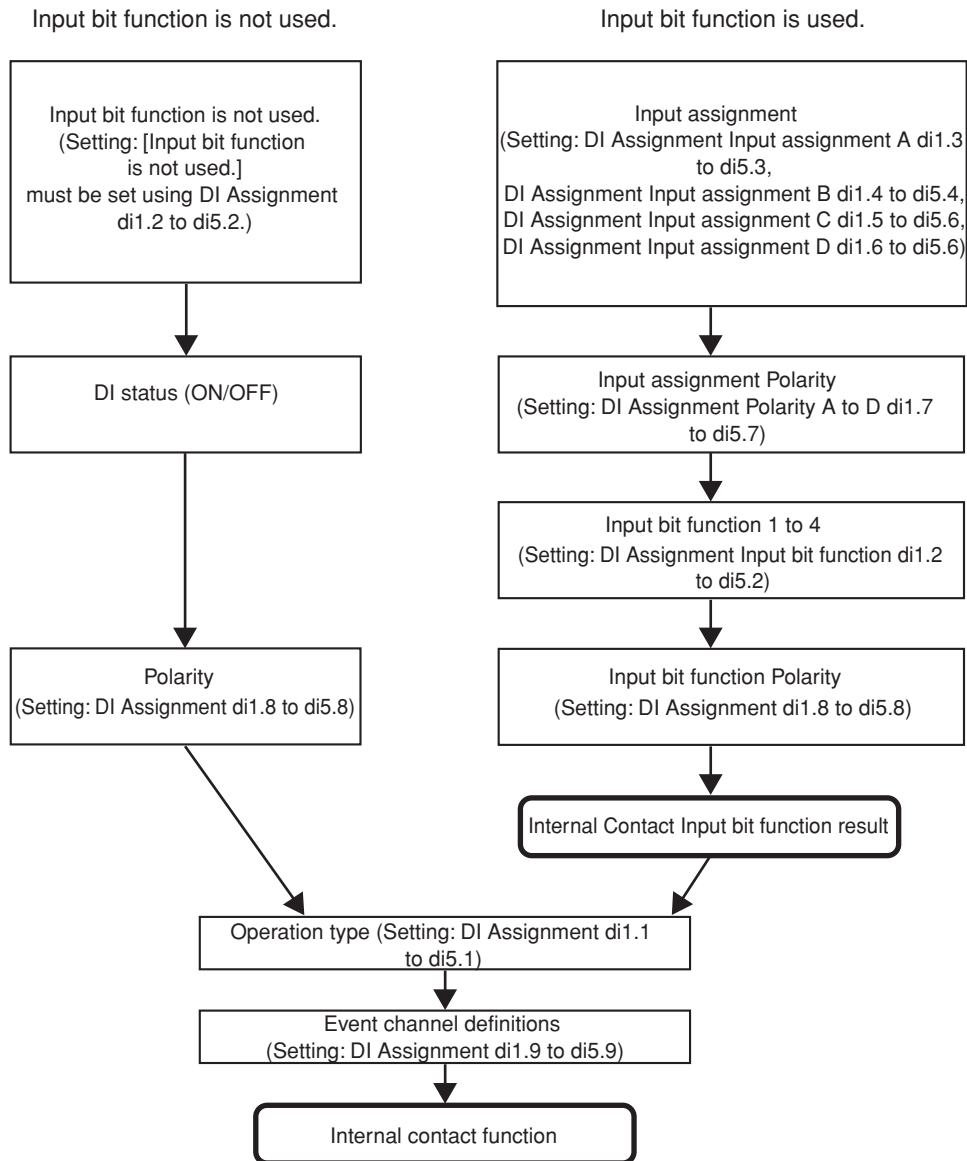

! Handling Precautions

Even though five internal contacts 1 to 5 are provided, the number of digital inputs determined by the optional model is 0 to 4 points.

With the default settings before shipment, the operations of digital input 1 to 4 have already been connected to internal contacts 1 to 4.

To utilize the operation of internal contact 5, it is absolutely necessary to set the DI Assignment.

■ Operation type

The operation type by the internal contact function can be set.

Item (Bank)	Display	Contents	Initial value	User level
Internal Contact 1 Operation type (DI Assignment bank)	d1 1.1	0 to 20 For details about function by each set value, refer to the Table shown on the next page.	0	Basic, Standard, High function
Internal Contact 2 Operation type (DI Assignment bank)	d1 2.1		0	
Internal Contact 3 Operation type (DI Assignment bank)	d1 3.1		0	
Internal Contact 4 Operation type (DI Assignment bank)	d1 4.1		0	
Internal Contact 5 Operation type (DI Assignment bank)	d1 5.1		0	

ⓘ Handling Precautions

- For [1 to 3: LSP group selection], the value that “1” is added to the sum of weights (+ 1, + 2, +4), the internal contact of which is turned ON, becomes the LSP group number. However, if this value exceeds the value set in [C30: LSP system group], LSP groups, the number of which is the same as the value set in [C30: LSP system group], are selected.
- For [4 to 6: PID group selection], a value made by adding “1” to the sum of weights (+1, +2, +4), the internal contact of which is turned ON, becomes the PID group number. However, if this value exceeds “8”, eight PID groups are selected.
- Do not use [14: PV value hold], [15: PV Max. hold], and [16: PV Min. hold] with they mixed.
- Do not set the same operation type other than [0: No function] and [1 to 3: LSP group selection] for multiple internal contacts.
- When using the Heat/Cool control, do not use [12: Control action direct/reverse selection].
- For timer stop/start, set a target Event channel using [Event channel definition of internal contact].

The following Table shows the contents of the dI settings:

Set value	Function	Operation at OFF	Operation at ON
0	No function	None	None
1	LSP group selection (0/+1)	LSP No.: +0	LSP No.: +1
2	LSP group selection (0/+2)	LSP No.: +0	LSP No.: +2
3	LSP group selection (0/+4)	LSP No.: +0	LSP No.: +4
4	PID group selection (0/+1)	PID group No.: +0	PID group No.: +1
5	PID group selection (0/+2)	PID group No.: +0	PID group No.: +2
6	PID group selection (0/+4)	PID group No.: +0	PID group No.: +4
7	RUN/READY mode selection (Note 1)	RUN	READY
8	AUTO/MANUAL mode selection	AUTO	MANUAL
9	LSP/RSP mode selection	LSP	RSP
10	AT (Auto tuning) Stop/Start (Note 2)	AT Stop	AT Start
11	ST (Self-tuning) disabled/enabled	Invalid	Invalid
12	Control action direct/reverse selection	Set action	Reverse action of setting
13	SP ramp enabled/disabled	SP ramp enabled	SP ramp disabled
14	PV value hold	No-hold	Hold
15	PV Max. hold	No-hold	Hold
16	PV Min. hold	No-hold	Hold
17	Timer Stop/Start	Timer stop	Timer start
18	Release all DO latches	Continue if latch exists.	Latch release
19	Advance operation (Note 3)	Step operation continued.	Moves to next SOAK or RAMP.
20	Step hold	Step operation continued.	Hold

(Note 1) Signal edge from OFF to ON or from ON to OFF is valid during step operation.

(Note 2) Signal edge from OFF to ON or from ON to OFF is valid.

(Note 3) Signal edge from OFF to ON is valid.

■ Event channel definitions

When the operation type is the timer start/stop, a target Event channel can be set.

Item (Bank)	Display	Contents	Initial value	User level
Internal Contact 1 Event channel definition (DI Assignment bank)	<i>di 1.9</i>	0: Every internal event 1 to 8: Internal event number	0	High function
Internal Contact 2 Event channel definition (DI Assignment bank)	<i>di 2.9</i>		0	
Internal Contact 3 Event channel definition (DI Assignment bank)	<i>di 3.9</i>		0	
Internal Contact 4 Event channel definition (DI Assignment bank)	<i>di 4.9</i>		0	
Internal Contact 5 Event channel definition (DI Assignment bank)	<i>di 5.9</i>		0	

- When the operation type of the same internal contact No. is set at “Timer stop/start”, the display and setting can be made.

■ **Input bit function**

Four kinds of input bit functions are provided. The required functions can be configured by the user.

Item (Bank)	Display	Contents	Initial value	User level
Internal Contact 1 Input bit function (DI Assignment bank)	<i>di 1.2</i>	0: Not used (Default input) 1: Function 1 ((A and B) or (C and D)) 2: Function 2 ((A or B) and (C or D)) 3: Function 3 (A or B or C or D) 4: Function 4 (A and B and C and D)	0	High function
Internal Contact 2 Input bit function (DI Assignment bank)	<i>di 2.2</i>		0	
Internal Contact 3 Input bit function (DI Assignment bank)	<i>di 3.2</i>		0	
Internal Contact 4 Input bit function (DI Assignment bank)	<i>di 4.2</i>		0	
Internal Contact 5 Input bit function (DI Assignment bank)	<i>di 5.2</i>		0	

- When the set value is “0”, the input bit function is not used and the default input is used. The following shows the default input of each internal contact:
 - Internal Contact 1: digital input (DI) 1
 - Internal Contact 2: digital input (DI) 2
 - Internal Contact 3: digital input (DI) 3
 - Internal Contact 4: digital input (DI) 4
 - Internal Contact 5: OFF status
- In the input bit function, the logical operations (AND, OR) of each of internal contacts 1 to 5 are combined. In input bit functions 1 to 4, the combination of the logical operations may vary. The following shows one logical operation:

Logical AND	Logical OR
OFF and OFF = OFF	OFF or OFF = OFF
ON and OFF = OFF	ON or OFF = ON
ON and ON = ON	ON or ON = ON
- “OFF” is “contact open (OPEN)” or “0” when expressed using the numerical value.
- “ON” is “contact close (CLOSE)” or “1” when expressed using the numerical value.

■ Input assignment

The assignment of four inputs (A, B, C, D) used for the input bit function can be set.

Item (Bank)	Display	Contents	Initial value	User level
Internal Contact 1 Input assignment A (DI Assignment bank)	<i>d1 13</i>	0: Normally opened. (OFF, 0) 1: Normally closed. (ON, 1) 2: DI1 3: DI2 4: DI3 5: DI4 6 to 9: Undefined. 10: Internal Event 1 11: Internal Event 2 12: Internal Event 3 13: Internal Event 4 14: Internal Event 5 15: Internal Event 6 16: Internal Event 7 17: Internal Event 8 18: Communication DI1 19: Communication DI2 20: Communication DI3 21: Communication DI4 22: MANUAL mode 23: READY mode 24: RSP mode 25: AT running 26: During SP ramp 27: Undefined. 28: Alarm occurs. 29: PV alarm occurs. 30: Undefined. 31: mode key pressing status 32: Event output 1 status 33: Control output 1 status	2	High function
Internal Contact 1 Input assignment B (DI Assignment bank)	<i>d1 14</i>		0	
Internal Contact 1 Input assignment C (DI Assignment bank)	<i>d1 15</i>		0	
Internal Contact 1 Input assignment D (DI Assignment bank)	<i>d1 16</i>		0	
Internal Contact 2 Input assignment A (DI Assignment bank)	<i>d1 23</i>		3	
Internal Contact 2 Input assignment B (DI Assignment bank)	<i>d1 24</i>		0	
Internal Contact 2 Input assignment C (DI Assignment bank)	<i>d1 25</i>		0	
Internal Contact 2 Input assignment D (DI Assignment bank)	<i>d1 26</i>		0	
Internal Contact 3 Input assignment A (DI Assignment bank)	<i>d1 33</i>		4	
Internal Contact 3 Input assignment B (DI Assignment bank)	<i>d1 34</i>		0	
Internal Contact 3 Input assignment C (DI Assignment bank)	<i>d1 35</i>		0	
Internal Contact 3 Input assignment D (DI Assignment bank)	<i>d1 36</i>		0	
Internal Contact 4 Input assignment A (DI Assignment bank)	<i>d1 43</i>		5	
Internal Contact 4 Input assignment B (DI Assignment bank)	<i>d1 44</i>		0	
Internal Contact 4 Input assignment C (DI Assignment bank)	<i>d1 45</i>		0	
Internal Contact 4 Input assignment D (DI Assignment bank)	<i>d1 46</i>		0	

(Continue on next page.)

Chapter 5. DETAILED DESCRIPTION OF EACH FUNCTION

Item (Bank)	Display	Contents	Initial value	User level
Internal Contact 5 Input assignment A (DI Assignment bank)	d1 5.3	0: Normally opened. (OFF, 0) 1: Normally closed. (ON, 1) 2: DI1 3: DI2 4: DI3 5: DI4 6 to 9: Undefined. 10: Internal Event 1 11: Internal Event 2 12: Internal Event 3 13: Internal Event 4 14: Internal Event 5 15: Internal Event 6 16: Internal Event 7 17: Internal Event 8 18: Communication DI1 19: Communication DI2 20: Communication DI3 21: Communication DI4 22: MANUAL mode 23: READY mode 24: RSP mode 25: AT running 26: During SP ramp 27: Undefined. 28: Alarm occurs. 29: PV alarm occurs. 30: Undefined. 31: mode key pressing status 32: Event output 1 status 33: Control output 1 status	0	High function
Internal Contact 5 Input assignment B (DI Assignment bank)	d1 5.4		0	
Internal Contact 5 Input assignment C (DI Assignment bank)	d1 5.5		0	
Internal Contact 5 Input assignment D (DI Assignment bank)	d1 5.6		0	

- When the internal contact No. and its input bit functions 1 to 4 are set, the display and setting can be configured.

■ Polarity of input assignment

The polarity of four input assignments (A, B, C, D) used for the input bit function can be set.

Item (Bank)	Display	Contents	Initial value	User level
Internal Contact 1, Polarity A to D (DI Assignment bank)	d1 1.7	The digits are called 1st digit, 2nd digit, 3rd digit, and 4th digit from the right end. 1st digit: Input 2nd digit: Input 3rd digit: Input 4th digit: Input	0000	High function
Internal Contact 2, Polarity A to D (DI Assignment bank)	d1 2.7		0000	
Internal Contact 3, Polarity A to D (DI Assignment bank)	d1 3.7		0000	
Internal Contact 4, Polarity A to D (DI Assignment bank)	d1 4.7		0000	
Internal Contact 5, Polarity A to D (DI Assignment bank)	d1 5.7		0000	

- When the internal contact No. and its input bit functions 1 to 4 are set, the display and setting can be configured.

■ Polarity of input bit function

The polarity of the input bit function (functions 1 to 4) can be set.

Item (Bank)	Display	Contents	Initial value	User level
Internal Contact 1 Polarity (DI Assignment bank)	d1 1.8	0: Direct 1: Reverse	0	High function
Internal Contact 2 Polarity (DI Assignment bank)	d1 2.8		0	
Internal Contact 3 Polarity (DI Assignment bank)	d1 3.8		0	
Internal Contact 4 Polarity (DI Assignment bank)	d1 4.8		0	
Internal Contact 5 Polarity (DI Assignment bank)	d1 5.8		0	

■ DI Assignment setting with the SLP-C35 Smart Loader Package

When setting [DI Assignment] with the SLP-C35 Smart Loader Package, select [Edit (E)] → [Input port setup (O)] in that order from the [Input] menu. The input bit function, input assignment, polarity of input assignment, and polarity of input bit function can be easily set using visual images as shown below.

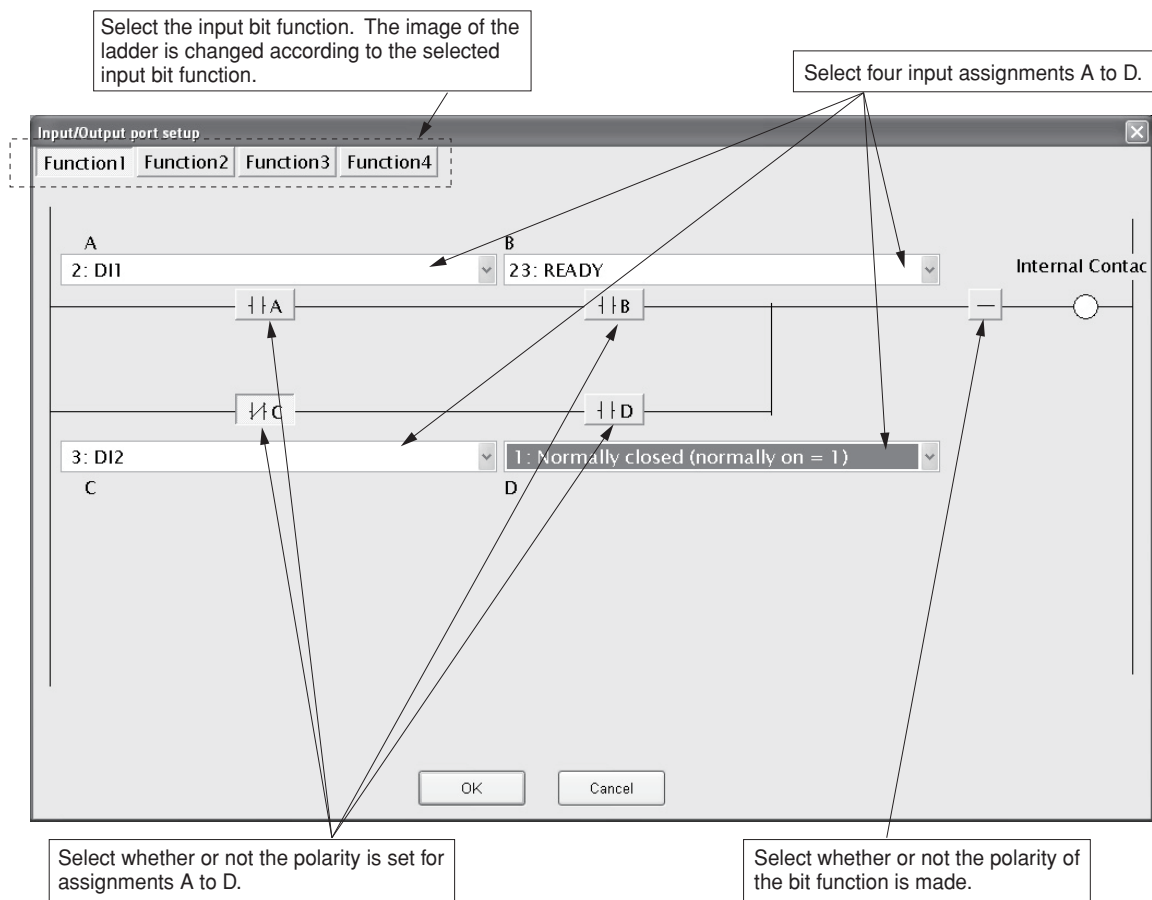

⚠ Handling Precautions

In addition to the selection through the menu, the Input port setup window can also be opened using the following procedures:

Click the input/output port setup icon .

Right-click in the input bit function setting window.

Press the [Ctrl] and [P] keys at the same time.

5 - 8 Internal Event

The result of the internal event process can be output to the control output or event output through the digital output (DO) process.

For details,

☞ 2-1, Input/Output Configuration (on page 2-1).

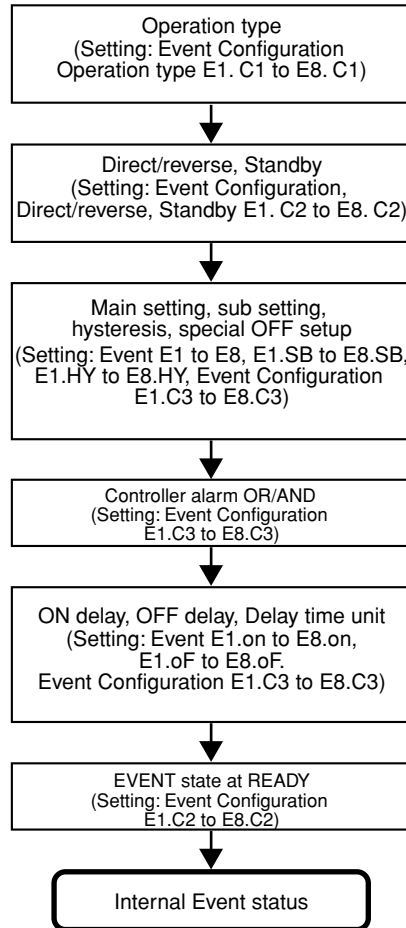

The following shows the functional block diagram of the internal event:

! Handling Precautions

Even though eight internal events 1 to 8 are provided, the number of event outputs determined by the optional model is 0 to 3 points. With the default settings before shipment, the operations of internal events 1 to 3 can be output to event outputs 1 to 3. To utilize the operations of internal events 4 to 8, it is absolutely necessary to set the DO Assignment.

■ Operation

According to the operation type, direct/reverse, main setting, sub setting, hysteresis, and other settings, the operation of the internal event becomes as follows:

[List of internal event operations]



Note

For details about unit (U), refer to the attached glossary.

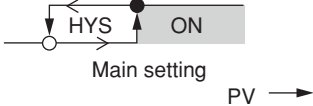
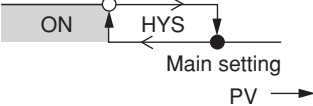
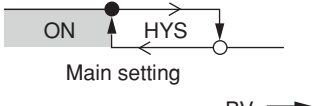
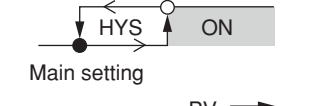
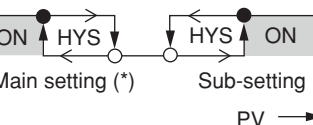
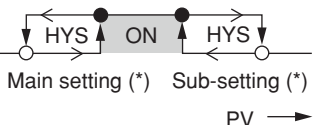
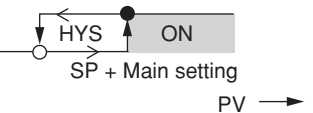
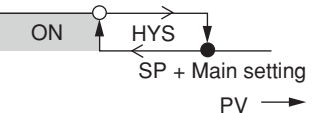
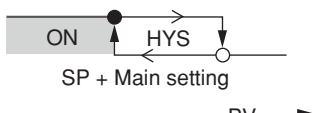
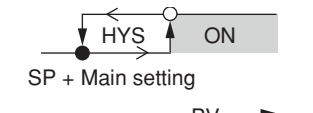
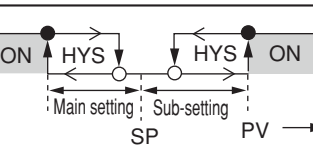
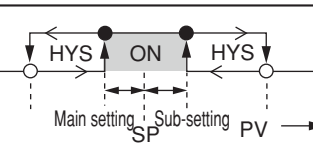
Operation type	Set value of operation type	Direct action ● shows that the ON/OFF is changed at this value. ○ shows that the ON/OFF is changed at a point that "1U" is added to this value.	Reverse action ● shows that the ON/OFF is changed at this value. ○ shows that the ON/OFF is changed at a point that "1U" is added to this value.
No event	0	Always OFF	Always OFF
PV high limit	1		
PV low limit	2		
PV high/low limit	3		
Deviation high limit	4		
Deviation low limit	5		
Deviation high/low limit	6		
Deviation high limit (Final SP reference)	7	Same as the direct action of the deviation high limit when the SP ramp is not used. The difference is that the SP ramp does not use the current SP, but it uses the final SP.	Same as the reverse action of the deviation high limit when the SP ramp is not used. The difference is that the SP ramp does not use the current SP, but it uses the final SP.
Deviation low limit (Final SP reference)	8	Same as the direct action of the deviation low limit when the SP ramp is not used. The difference is that the SP ramp does not use the current SP, but it uses the final SP.	Same as the reverse action of the deviation low limit when the SP ramp is not used. The difference is that the SP ramp does not use the current SP, but it uses the final SP.
Deviation high/low limit (Final SP reference)	9	Same as the direct action of the deviation high/low limit when the SP ramp is not used. The difference is that the SP ramp does not use the current SP, but it uses the final SP.	Same as the reverse action of the deviation high/low limit when the SP ramp is not used. The difference is that the SP ramp does not use the current SP, but it uses the final SP.

* If the setting is made so that the main setting is greater than the sub setting, the operation is performed with the main setting swapped for the sub setting automatically.

(Continue on next page.)

Chapter 5. DETAILED DESCRIPTION OF EACH FUNCTION

Operation type	Set value of operation type	Direct action ● shows that the ON/OFF is changed at this value. ○ shows that the ON/OFF is changed at a point that "1U" is added to this value.	Reverse action ● shows that the ON/OFF is changed at this value. ○ shows that the ON/OFF is changed at a point that "1U" is added to this value.
SP high limit	10		
SP low limit	11		
SP high/low limit	12		
MV high limit	13		
MV low limit	14		
MV high/low limit	15		
Heater 1 burnout/ Over-current(*2)	16		
Heater 1 short-circuit(*2)	17		
Heater 2 burnout/ Over-current(*2)	18		
Heater 2 short-circuit(*2)	19		

Operation type	Set value of operation type	Direct action	Reverse action
Loop diagnosis 1	20	<p>The event is turned ON when any change in PV corresponding to increase/decrease in Manipulated variable (MV) is not observed. This event is used to detect any fault at the operation end.</p> <ul style="list-style-type: none"> ● Setting items <ul style="list-style-type: none"> • Main setting: Manipulated variable (MV) • Sub-setting: PV • ON delay time: Diagnosis time ● Operation specifications <p>The event is turned ON when the value does not reach the PV set in the sub-setting within the diagnosis time (ON delay time) (conditions 1) even though the MV exceeding the main setting is held (conditions 2).</p> ● CAUTION <p>When setting the ON delay, it is necessary to put in "High function configuration". The default setting of the ON delay before shipment is 0.0s.</p> <div style="display: flex; justify-content: space-around;"> <div data-bbox="513 837 954 1335" style="width: 45%;"> <p>Heat control</p> <p>ON delay is started when conditions 1 and 2 are satisfied.</p> </div> <div data-bbox="976 837 1439 1335" style="width: 45%;"> <p>Cool control</p> <p>ON delay is started when conditions 1 and 2 are satisfied.</p> </div> </div>	

*1 If the setting is made so that the main setting is greater than the sub setting, the operation is performed with the main setting swapped for the sub setting automatically.

*2: When the event type is CT1/2 heater burnout/over-current or CT1/2 heater short-circuit, the status becomes that the event judgment cannot be made from the time of power ON until that CT input current value is measured for the first time. In this case, the internal event output is OFF for both of direct action and reverse action in the direct/reverse setting. To avoid that the output becomes OFF at power ON when used in reverse action, set as follows:

(Setting example)

For direct/reverse setting of CT1/2 heater burnout/over-current or CT1/2 short-circuit event, select the direct action, and set the reverse operation in DO assignment calculation of the event output terminal (event terminal or control output terminal).

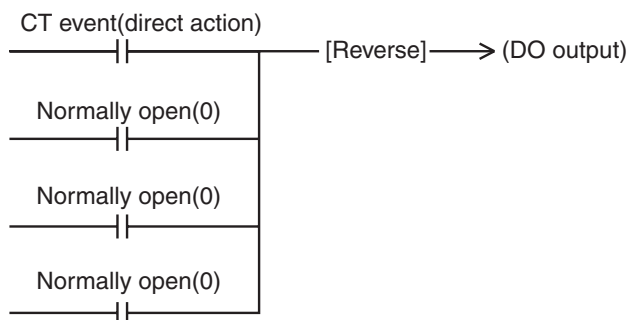

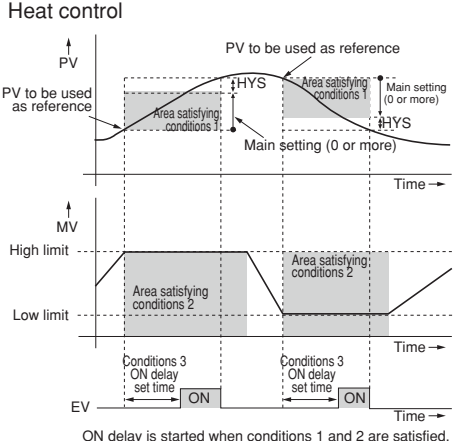
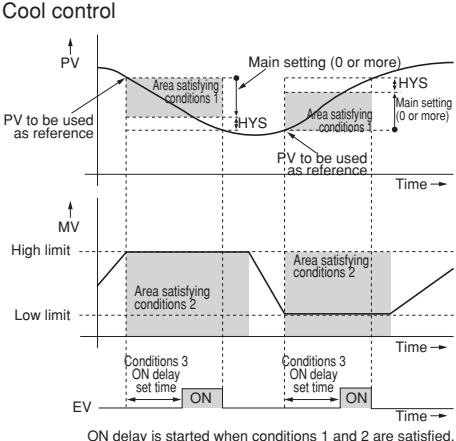

Operation type	Set value of operation type	Direct action	Reverse action
Loop diagnosis 2	21	<p>The event is turned ON when any change in PV corresponding to increase/decrease in Manipulated variable (MV) is not observed.</p> <p>This event is used to detect any fault at the operation end.</p> <ul style="list-style-type: none"> ● Setting items <ul style="list-style-type: none"> • Main setting: Manipulated variable (MV) • Sub-setting: Change in PV from the point that the MV exceeds the main setting. • ON delay time: Diagnosis time ● Operation specifications <p>The event is turned ON when the MV exceeding the main setting is held (conditions 2) and the PV does not reach the value that the sub-setting is added to (subtracted from) the PV at the point that the MV exceeds the main setting within the diagnosis time (ON delay time) (conditions 1).</p> ● CAUTION <p>When setting the ON delay, it is necessary to put in "High function configuration". The default setting of the ON delay before shipment is 0.0s.</p> 	<div style="display: flex; justify-content: space-between;"> <div style="width: 48%;"> <p>Heat control</p> <p>ON delay is started when conditions 1 and 2 are satisfied.</p> </div> <div style="width: 48%;"> <p>Cool control</p> <p>ON delay is started when conditions 1 and 2 are satisfied.</p> </div> </div>

(Continue on next page.)

Operation type	Set value of operation type	Direct action	Reverse action
Loop diagnosis 3	22	<p>The event is turned ON when any change in PV corresponding to increase/decrease in Manipulated variable (MV) is not observed. This event is used to detect any fault at the operation end.</p> <ul style="list-style-type: none"> ● Setting items <ul style="list-style-type: none"> • Main setting: Change in PV from the point that the MV reaches the high limit (100%) or low limit (0%). • Sub-setting: Range of absolute value of deviation (PV-SP) allowing the event to hold OFF state. • ON delay time: Diagnosis time • OFF delay time: A period of time from power ON allowing the event to hold OFF state. ● Operation specifications <p>The direct action is used for the heat control and is turned ON in the following cases:</p> <ul style="list-style-type: none"> • The increase in PV becomes smaller than the main setting after the diagnosis time (ON delay time) has elapsed after the MV had reached the high limit. • The decrease in PV becomes smaller than the main setting after the diagnosis time (ON delay time) has elapsed after the MV had reached the low limit. <p>The reverse action is used for the cool control and is turned ON in the following cases:</p> <ul style="list-style-type: none"> • The decrease in PV becomes smaller than the main setting after the diagnosis time (ON delay time) has elapsed after the MV had reached the high limit. • The increase in PV becomes smaller than the main setting after the diagnosis time (ON delay time) has elapsed after the MV had reached the low limit. <p>In the following cases, the event is turned OFF with the priority over the above conditions:</p> <ul style="list-style-type: none"> • The absolute value of the deviation (PV-SP) becomes less than the sub-setting. <p>However, the event is turned OFF when the absolute value of the deviation is less than the (sub setting – hysteresis) value after the absolute value of the deviation has become the sub setting or more.</p> <ul style="list-style-type: none"> • A period of time after the operation has been started by power ON is less than the OFF delay time. ● CAUTION <p>When setting the ON delay and OFF delay, it is necessary to put in " High function configuration".</p> <p>The default settings of the ON delay and OFF delay before shipment are 0.0s.</p> 	
		<p>Heat control</p>  <p>ON delay is started when conditions 1 and 2 are satisfied.</p>	<p>Cool control</p>  <p>ON delay is started when conditions 1 and 2 are satisfied.</p>

(Continue on next page.)

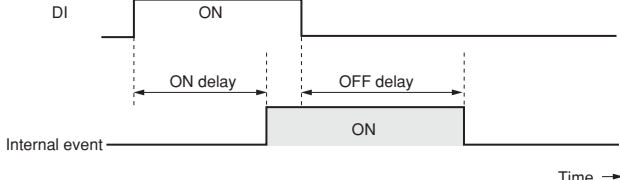
Chapter 5. DETAILED DESCRIPTION OF EACH FUNCTION

Operation type	Set value of operation type	Direct action	Reverse action
Alarm (status)	23	ON if alarm occurs (alarm code AL01 to 99). OFF in other cases.	OFF if alarm occurs (alarm code AL01 to 99). ON in other cases.
READY (status)	24	ON in the READY mode. OFF in the RUN mode.	OFF in the READY mode. ON in the RUN mode.
MANUAL (status)	25	ON in the MANUAL mode. OFF in the AUTO mode.	OFF in the MANUAL mode. ON in the AUTO mode.
RSP (status)	26	ON in the RSP mode. OFF in the LSP mode.	OFF in the RSP mode. ON in the LSP mode.
During AT (Status)	27	ON when AT is executed. OFF when AT is stopped.	OFF when AT is executed. ON when AT is stopped.
During SP ramp	28	ON during SP ramp. OFF when SP ramp is not performed or is completed.	OFF during SP ramp. ON when SP ramp is not performed or is completed.
Control action (status)	29	ON during direct action (cooling). OFF during reverse action (heating).	OFF during direct action (cooling). ON during reverse action (heating).
ST setting standby (status)	30	Invalid in this unit. Always OFF.	Invalid in this unit. Always ON.
During estimated position control (status)	31	ON during estimated position control. OFF when not estimated.	OFF during estimated position control. ON when not estimated.
Timer (status)	32	<p>The direct and reverse action settings are disabled for the timer event. When using the timer event, it is necessary to set the operation type of the DI assignment to "Timer Start/Stop". Additionally, when setting the event channel designation of the DI assignment, multiple timer events are controlled from individual internal contacts (DI).</p> <ul style="list-style-type: none"> ● Setting items <ul style="list-style-type: none"> • ON delay time: A period of time necessary for the event change from OFF to ON after DI has been changed from OFF to ON. • OFF delay time: A period of time necessary for the event change from ON to OFF after DI has been changed from ON to OFF. ● Operation specifications <ul style="list-style-type: none"> • The event is turned ON when DI ON continues for ON delay time or longer. • The event is turned OFF when DI OFF continues for OFF delay time. • In other cases, the current status is continued.  <ul style="list-style-type: none"> ● CAUTION <p>When setting the ON delay and OFF delay, it is necessary to put in "High function configuration". The default settings of the ON delay and OFF delay before shipment are 0.0s. The default setting of the event channel designation of the DI assignment before shipment is "0". In this case, the timer event start/stop can be set for all internal events from one internal contact (DI). Additionally, as one or more event channel designation is set, the timer event start/stop can be set for one internal event specified by one internal contact (DI). However, when setting the event channel of the DI assignment, it is necessary to put in "High function configuration".</p> 	
High and low limits of MFB value	33		

*1 If the setting is made so that the main setting is greater than the sub setting, the operation is performed with the main setting swapped for the sub setting automatically.

■ Operation type

The operation type of the internal event can be set.

Item (Bank)	Display	Contents	Initial value	User level
Internal Event 1 Configuration 1 Operation type (Event Configuration bank)	E 1C 1	0: No event 1: PV high limit 2: PV low limit 3: PV high/low limit 4: Deviation high limit	0	Basic, Standard, High function
Internal Event 2 Configuration 1 Operation type (Event Configuration bank)	E 2C 1	5: Deviation low limit 6: Deviation high/low limit 7: Deviation high limit (Final SP reference)	0	
Internal Event 3 Configuration 1 Operation type (Event Configuration bank)	E 3C 1	8: Deviation low limit (Final SP reference) 9: Deviation high/low limit (Final SP reference)	0	
Internal Event 4 Configuration 1 Operation type (Event Configuration bank)	E 4C 1	10: SP high limit 11: SP low limit 12: SP high/low limit 13: MV high limit 14: MV low limit 15: MV high/low limit	0	
Internal Event 5 Configuration 1 Operation type (Event Configuration bank)	E 5C 1	16: CT1 heater burnout/over-current 17: CT1 heater short-circuit 18: CT2 heater burnout/over-current 19: CT2 heater short-circuit	0	
Internal Event 6 Configuration 1 Operation type (Event Configuration bank)	E 6C 1	20: Loop diagnosis 1 21: Loop diagnosis 2 22: Loop diagnosis 3 23: Alarm (status) 24: READY (status) 25: MANUAL (status)	0	
Internal Event 7 Configuration 1 Operation type (Event Configuration bank)	E 7C 1	26: RSP (status) 27: During AT execution (status) 28: During SP ramp (status) 29: Control direct action (status)	0	
Internal Event 8 Configuration 1 Operation type (Event Configuration bank)	E 8C 1	30: ST setting standby (status) (Invalid in this unit.) 31: During estimated position control (status) 32: Timer (status) 33: High and Low limits of MFB value (Invalid in this unit)	0	

! Handling Precautions

- If ROM version 1 of the instrument information bank (*1002*) is prior to 2.04, “33” cannot be set as [Internal Event configuration 1 operation type].

■ Direct/reverse, standby, and EVENT state at READY

Direct/reverse, standby, and EVENT state at READY accompanying with the operation type can be set.

Item (Bank)	Display	Contents	Initial value	User level
Internal Event 1 Configuration 2 (Event Configuration bank)	E 1.C2	The digits are called 1st digit, 2nd digit, 3rd digit, and 4th digit from the right end. 1st digit: Direct/reverse setup 0: Direct 1: Reverse 2nd digit: Standby setup 0: None 1: Standby 2: Standby + Standby at SP change 3rd digit: EVENT state at READY setup 0: Continued. 1: Forced OFF 4th digit: Undefined. 0: Undefined.	0000	Basic, Standard, High function
Internal Event 2 Configuration 2 (Event Configuration bank)	E 2.C2		0000	
Internal Event 3 Configuration 2 (Event Configuration bank)	E 3.C2		0000	
Internal Event 4 Configuration 2 (Event Configuration bank)	E 4.C2		0000	
Internal Event 5 Configuration 2 (Event Configuration bank)	E 5.C2		0000	
Internal Event 6 Configuration 2 (Event Configuration bank)	E 6.C2		0000	
Internal Event 7 Configuration 2 (Event Configuration bank)	E 7.C2		0000	
Internal Event 8 Configuration 2 (Event Configuration bank)	E 8.C2		0000	

- When the internal event configuration 1 operation type is set at [0: No event], the internal event configuration 2 (direct/reverse, standby, and EVENT state at READY) is not displayed.
- For details about internal event operation with the direct/reverse setting,  List of internal event operations (on pages 5-59 to 5-64).

ⓘ Handling Precautions

- “Standby” is a function that does not turn ON the event even though the event currently used satisfies the ON conditions (before polarity) when the instrument power is turned ON or when the READY mode is changed to the RUN mode. The event is turned ON when the ON conditions are satisfied again once the OFF conditions have been satisfied.
- “Standby + Standby at SP change” means that the standby is set again when the SP is changed (SP value and LSP group number) in addition to the standby functions. However, when the same SP value is written or when the SP value is not changed even though the LSP group number is changed, the unit does not enter the standby mode.

		READY		READY → RUN change	
EVENT state at READY setup Standby setup	0:Continued	0:Continued	1: Forced OFF	0: Continued	1: Forced OFF
	0: None	Usual operation	OFF	Usual operation	Usual operation
	1: Standby	OFF	OFF	OFF(standby state)	OFF(standby state)
	2: Standby+ Standby at SP change	OFF	OFF	OFF(standby state)	OFF(standby state)

■ Alarm OR, special OFF setup, and delay time unit

Alarm OR, special OFF setup, and delay time unit accompanying with the operation type can be set.

Item (Bank)	Display	Contents	Initial value	User level
Internal Event 1 Configuration 3 (Event Configuration bank)	E 1 C 3	The digits are called 1st digit, 2nd digit, 3rd digit, and 4th digit from the right end. 1st digit: Alarm OR setup 0: None	0000	High function
Internal Event 2 Configuration 3 (Event Configuration bank)	E 2 C 3	1: Alarm direct + OR operation 2: Alarm direct + AND operation 3: Alarm reverse + OR operation 4: Alarm reverse + AND operation	0000	
Internal Event 3 Configuration 3 (Event Configuration bank)	E 3 C 3	2nd digit: Special OFF setup 0: As usual. 1: When EV main setting is "0", the event is set to "OFF".	0000	
Internal Event 4 Configuration 3 (Event Configuration bank)	E 4 C 3	3rd digit: Delay time unit setup 0: 0.1s 1: 1s 2: 1min.	0000	
Internal Event 5 Configuration 3 (Event Configuration bank)	E 5 C 3	4th digit: Undefined. 0: Undefined.	0000	
Internal Event 6 Configuration 3 (Event Configuration bank)	E 6 C 3		0000	
Internal Event 7 Configuration 3 (Event Configuration bank)	E 7 C 3		0000	
Internal Event 8 Configuration 3 (Event Configuration bank)	E 8 C 3		0000	

- When the internal event configuration 1 operation type is set at [0: No event], the internal event configuration 3 (alarm OR, special OFF setup, and delay time unit) is not displayed.

The following shows the relationship among alarm OR setting, alarm occurred/not occurred, and internal event ON/OFF:

Alarm OR setting	Alarm (AL01 to 99) occurred/not occurred	Internal event ON/OFF status before alarm OR process	Internal event ON/OFF status after alarm OR process
None	Not occurred	OFF	OFF
	Not occurred	ON	ON
	Occurred.	OFF	OFF
	Occurred.	ON	ON
Alarm direct + OR operation	Not occurred	OFF	OFF
	Not occurred	ON	ON
	Occurred.	OFF	ON
	Occurred.	ON	ON
Alarm direct + AND operation	Not occurred	OFF	OFF
	Not occurred	ON	OFF
	Occurred.	OFF	OFF
	Occurred.	ON	ON
Alarm reverse + OR operation	Not occurred	OFF	ON
	Not occurred	ON	ON
	Occurred.	OFF	OFF
	Occurred.	ON	ON
Alarm reverse + AND operation	Not occurred	OFF	OFF
	Not occurred	ON	ON
	Occurred.	OFF	OFF
	Occurred.	ON	OFF

■ Main setting, sub setting, and hysteresis

Main setting, sub setting, and hysteresis accompanying with the operation type can be set.

Item (Bank)	Display	Contents	Initial value	User level
Internal Event 1 Main setting (Event bank)	E 1	-1999 to +9999 The decimal point position may vary so that it meets the operation type. The above value becomes 0 to 9999 in some operation types.	0	Basic, Standard, High function
Internal Event 1 Sub-setting (Event bank)	E 1.5b	-1999 to +9999 The decimal point position may vary so that it meets the operation type. The above value becomes 0 to 9999 in some operation types.	0	
Internal Event 1 Hysteresis (Event bank)	E 1.HY	0 to 9999 The decimal point position may vary so that it meets the operation type.	5	
Internal Event 2 Main setting (Event bank)	E 2	Same as Internal Event 1 Main setting.	0	
Internal Event 2 Sub-setting (Event bank)	E 2.5b	Same as Internal Event 1 Sub setting.	0	
Internal Event 2 Hysteresis (Event bank)	E 2.HY	Same as Internal Event 1 Hysteresis.	5	
Internal Event 3 Main setting (Event bank)	E 3	Same as Internal Event 1 Main setting.	0	
Internal Event 3 Sub-setting (Event bank)	E 3.5b	Same as Internal Event 1 Sub setting.	0	
Internal Event 3 Hysteresis (Event bank)	E 3.HY	Same as Internal Event 1 Hysteresis.	5	
Internal Event 4 Main setting (Event bank)	E 4	Same as Internal Event 1 Main setting.	0	
Internal Event 4 Sub-setting (Event bank)	E 4.5b	Same as Internal Event 1 Sub setting.	0	
Internal Event 4 Hysteresis (Event bank)	E 4.HY	Same as Internal Event 1 Hysteresis.	5	
Internal Event 5 Main setting (Event bank)	E 5	Same as Internal Event 1 Main setting.	0	
Internal Event 5 Sub-setting (Event bank)	E 5.5b	Same as Internal Event 1 Sub setting.	0	
Internal Event 5 Hysteresis (Event bank)	E 5.HY	Same as Internal Event 1 Hysteresis.	5	
Internal Event 6 Main setting (Event bank)	E 6	Same as Internal Event 1 Main setting.	0	
Internal Event 6 Sub-setting (Event bank)	E 6.5b	Same as Internal Event 1 Sub setting.	0	
Internal Event 6 Hysteresis (Event bank)	E 6.HY	Same as Internal Event 1 Hysteresis.	5	
Internal Event 7 Main setting (Event bank)	E 7	Same as Internal Event 1 Main setting.	0	
Internal Event 7 Sub-setting (Event bank)	E 7.5b	Same as Internal Event 1 Sub setting.	0	
Internal Event 7 Hysteresis (Event bank)	E 7.HY	Same as Internal Event 1 Hysteresis.	5	

(Continue on next page.)

Item (Bank)	Display	Contents	Initial value	User level
Internal Event 8 Main setting (Event bank)	<i>E8</i>	Same as Internal Event 1 Main setting.	0	Basic, Standard, High function
Internal Event 8 Sub-setting (Event bank)	<i>E8.5b</i>	Same as Internal Event 1 Sub setting.	0	
Internal Event 8 Hysteresis (Event bank)	<i>E8.HY</i>	Same as Internal Event 1 Hysteresis.	5	

- When the internal event configuration 1 operation type is set at [0: No event], the internal event main setting, sub-setting, and hysteresis are not displayed.
- For details about internal event operation with main setting, sub-setting, and hysteresis,
 - ➔ List of internal event operations (on pages 5-59 to 5-64).

■ ON delay and OFF delay

ON delay is a function that delays the timing, at which the internal event status is changed from OFF to ON.

OFF delay is a function that delays the timing, at which the internal event status is changed from ON to OFF.

However, when the operation type is set at [20: Loop diagnosis 1], [21: Loop diagnosis 2], [22: Loop diagnosis 3], or [32: Timer], the ON delay and OFF delay are operated as another function.

For details,

- ➔ List of internal event operations (on pages 5-59 to 5-64).

ON delay and OFF delay can be set.

Item (Bank)	Display	Contents	Initial value	User level
Internal Event 1 ON delay (Event bank)	<i>E 1.oN</i>	0.0 to 999.9s (Delay time unit is "0.1s".) 0 to 9999s (Delay time unit is "1s".) 0 to 9999min (Delay time unit is "1min".)	0.0s or 0s or 0min	High function
Internal Event 1 OFF delay (Event bank)	<i>E 1.oF</i>	Same as internal event 1 ON delay.	0.0s or 0s or 0min	
Internal Event 2 ON delay (Event bank)	<i>E 2.oN</i>	Same as internal event 1 ON delay.	0.0s or 0s or 0min	
Internal Event 2 OFF delay (Event bank)	<i>E 2.oF</i>	Same as internal event 1 ON delay.	0.0s or 0s or 0min	
Internal Event 3 ON delay (Event bank)	<i>E 3.oN</i>	Same as internal event 1 ON delay.	0.0s or 0s or 0min	
Internal Event 3 OFF delay (Event bank)	<i>E 3.oF</i>	Same as internal event 1 ON delay.	0.0s or 0s or 0min	
Internal Event 4 ON delay (Event bank)	<i>E 4.oN</i>	Same as internal event 1 ON delay.	0.0s or 0s or 0min	
Internal Event 4 OFF delay (Event bank)	<i>E 4.oF</i>	Same as internal event 1 ON delay.	0.0s or 0s or 0min	

(Continue on next page.)

Chapter 5. DETAILED DESCRIPTION OF EACH FUNCTION

Item (Bank)	Display	Contents	Initial value	User level
Internal Event 5 ON delay (Event bank)	<i>E5.on</i>	Same as internal event 1 ON delay.	0.0s or 0s or 0min	High function
Internal Event 5 OFF delay (Event bank)	<i>E5.oF</i>	Same as internal event 1 ON delay.	0.0s or 0s or 0min	
Internal Event 6 ON delay (Event bank)	<i>E6.on</i>	Same as internal event 1 ON delay.	0.0s or 0s or 0min	
Internal Event 6 OFF delay (Event bank)	<i>E6.oF</i>	Same as internal event 1 ON delay.	0.0s or 0s or 0min	
Internal Event 7 ON delay (Event bank)	<i>E7.on</i>	Same as internal event 1 ON delay.	0.0s or 0s or 0min	
Internal Event 7 OFF delay (Event bank)	<i>E7.oF</i>	Same as internal event 1 ON delay.	0.0s or 0s or 0min	
Internal Event 8 ON delay (Event bank)	<i>E8.on</i>	Same as internal event 1 ON delay.	0.0s or 0s or 0min	
Internal Event 8 OFF delay (Event bank)	<i>E8.oF</i>	Same as internal event 1 ON delay.	0.0s or 0s or 0min	

- When the internal event configuration 1 operation type is set at [0: No event], the internal event ON delay and OFF delay are not displayed.

5 - 9 Digital Output (DO)

The following shows the functional block diagram of the digital output (DO):

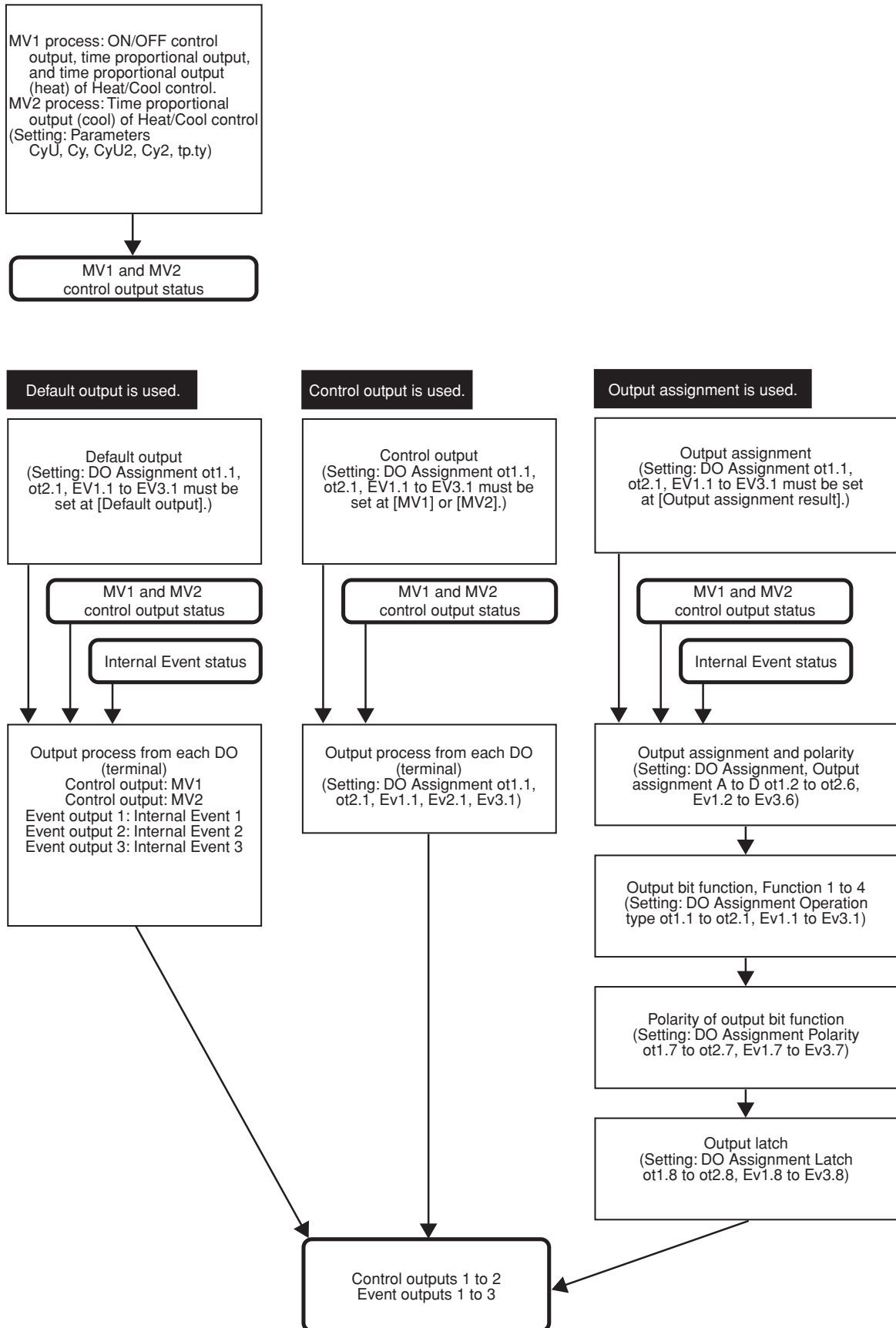

■ MV1/MV2 process

The time proportional cycle and time proportional cycle mode of MV1/MV2 can be set.

Item (Bank)	Display	Contents	Initial value	User level
Time proportional unit 1 (for MV1) (Parameter bank)	CyU	0: 1s unit 1: Cycle fixed at 0.5s. 2: Cycle fixed at 0.25s. 3: Cycle fixed at 0.1s If the set value is other than "0", the time proportional cycle 1 (Cy) cannot be set.	0	High function
Time proportional cycle 1 (for MV1) (Parameter bank)	Cy	5 to 120s (Output destination of MV1 includes the relay output.) 1 to 120s (Output destination of MV1 does not include the relay output.) If the time proportional unit 1 (CyU) ≠ 0, this setting becomes invalid and the setting becomes impossible.	10 or 2s	Basic, Standard, High function
Time proportional unit 2 (for MV2) (Parameter bank)	CyU2	0: 1s unit 1: Cycle fixed at 0.5s. 2: Cycle fixed at 0.25s. 3: Cycle fixed at 0.1s If the set value is other than "0", the time proportional cycle 2 (Cy2) cannot be set.	0	High function
Time proportional cycle 2 (for MV2) (Parameter bank)	Cy2	5 to 120s (Output destination of MV2 includes the relay output.) 1 to 120s (Output destination of MV2 does not include the relay output.) If the time proportional unit 2 (CyU2) ≠ 0, this setting becomes invalid and the setting becomes impossible.	10 or 2s	Basic, Standard, High function
Time proportional cycle mode (Parameter bank)	EP.ty	0: Controllability aiming type 1: Operation service life aiming type (ON/OFF operation is performed only once within the time proportional cycle.	0 or 1	High function

- MV1 is the general term for the ON/OFF control output, time proportional output, and time proportional output for heat side of the Heat/Cool control. MV2 is the time proportional output for cool side of the Heat/Cool control.
- When MV1 is connected only to the voltage pulse output in the DO Assignment, the display and setting of the time proportional unit 1 (CyU) can be performed.
- When MV1 is connected to any of the relay control output, voltage pulse control output, and event output in the DO Assignment, the display and setting of the time proportional cycle 1 (Cy) can be made. However, when the time proportional unit 1 (CyU) is other than "0", the display and setting of the time proportional cycle 1 (Cy) cannot be performed.
- When the Heat/Cool control is used and MV2 is connected only to the voltage pulse output in the DO Assignment, the display and setting of the time proportional unit 2 (CyU2) can be performed.
- When the Heat/Cool control is used and MV2 is connected to any of the relay control output, voltage pulse control output, and event output in the DO Assignment, the display and setting of the time proportional cycle 2 (Cy2) can be made. However, when the time proportional unit 2 (CyU2) is other than "0", the display and setting of the time proportional cycle 2 (Cy2) cannot be performed.
- The initial value of the time proportional cycle 1 (Cy) is "10" when the control output 1 is the relay output and it is "2" in other cases.
- The initial value of the time proportional cycle 2 (Cy2) is "10" when a model with one control output point is used and it is "2" when other models are used.

-
- The setting of the time proportional cycle mode (tP.ty) is valid to the time proportional outputs of both MV1 and MV2.
 - When MV1 is connected to the relay control output or event output in the DO Assignment and the time proportional cycle 1 (Cy) is set at less than “5s”, the operation is performed at intervals of 5s.
 - When MV2 is connected to the relay control output or event output in the DO Assignment and the time proportional cycle 2 (Cy2) is set at less than “5s”, the operation is performed at intervals of 5s.

Handling Precautions

- The following shows the resolution of the time proportional output by the setting of the time proportional unit 1 and 2 (CyU/CyU2):
 - When this setting is set at “0” (1s unit), the resolution becomes “1/1000” (seconds of the time proportional cycle X 1/1000).
 - When this setting is set at “1” (Cycle fixed at “0.5s”), the resolution becomes “1/500 (1ms)”.
 - When this setting is set at “2” (Cycle fixed at “0.25s”), the resolution becomes “1/250 (1ms)”.
 - When this setting is set at “3” (Cycle fixed at “0.1s”), the resolution becomes “1/100 (1ms)”.
- The time proportional cycle is operated for a period of time approximately 2.4% longer than the setting. Care should be taken when using the timer function with the time proportional output. Use the ON delay/ OFF delay and DI timer stop/start functions with the timer function of the internal event, if the ON/OFF output having more precise time is needed.

■ Operation type

The outputs of the control outputs 1 to 2 and event outputs 1 to 3 can be set using the operation type of the DO Assignment.

Item (Bank)	Display	Contents	Initial value	User level
Control output 1 Operation type (DO bank)	ot 1.1	0: Default output 1: MV1 2: MV2 3: Function 1 ((A and B) or (C and D)) 4: Function 2 ((A or B) and (C or D)) 5: Function 3 (A or B or C or D) 6: Function 4 (A and B and C and D)	0	High function
Control output 2 Operation type (DO bank)	ot 2.1		0	
Event output 1 Operation type (DO bank)	Ev 1.1		0	
Event output 2 Operation type (DO bank)	Ev 2.1		0	
Event output 3 Operation type (DO bank)	Ev 3.1		0	

- When the control output is the relay output or voltage pulse output, the display and setting can be made.
- When the event output is provided, the display and setting can be made.
- MV1 is the ON/OFF control output, time proportional output, and time proportional output (heat) of the Heat/Cool control.
- MV2 is the time proportional output (cool) of the Heat/Cool control.
- When the set value is “0” (default output), the operation becomes as follows according to the output:
 - Control output 1: Control output status of MV1 is output.
 - Control output 2: Control output status of MV2 is output.
 - Event output 1: Result of Internal Event 1 is output.
 - Event output 2: Result of Internal Event 2 is output.
 - Event output 3: Result of Internal Event 3 is output.
- In the output bit function, the logical operations (AND, OR) of each control output and each event output are combined. In output bit functions 1 to 4, the combination of the logical operations may vary. The following shows one logical operation:

Logical AND	Logical OR
OFF and OFF = OFF	OFF or OFF = OFF
OFF and ON = OFF	OFF or ON = ON
ON and OFF = OFF	ON or OFF = ON
ON and ON = ON	ON or ON = ON

■ Output assignment

The assignments of four inputs (A, B, C, D) used for the output bit function can be set.

Item (Bank)	Display	Contents	Initial value	User level
Control output 1 Output assignment A (DO Assignment bank)	ot 1.2	0: Normally opened. (OFF, 0) 1: Normally closed. (ON, 1)	14	High function
Control output 1 Output assignment B (DO Assignment bank)	ot 1.3	2: Internal Event 1 3: Internal Event 2 4: Internal Event 3 5: Internal Event 4 6: Internal Event 5	0	
Control output 1 Output assignment C (DO Assignment bank)	ot 1.4	7: Internal Event 6 8: Internal Event 7 9: Internal Event 8	0	
Control output 1 Output assignment D (DO Assignment bank)	ot 1.5	10 to 13: Undefined. 14: MV1 15: MV2 16 to 17: Undefined.	0	
Control output 2 Output assignment A (DO Assignment bank)	ot 2.2	18: DI1 19: DI2 20: DI3 21: DI4	15	
Control output 2 Output assignment B (DO Assignment bank)	ot 2.3	22 to 25: Undefined. 26: Internal Contact 1 27: Internal Contact 2	0	
Control output 2 Output assignment C (DO Assignment bank)	ot 2.4	28: Internal Contact 3 29: Internal Contact 4 30: Internal Contact 5	0	
Control output 2 Output assignment D (DO Assignment bank)	ot 2.5	31 to 33: Undefined. 34: Communication DI1 35: Communication DI2 36: Communication DI3	0	
Event output 1 Output assignment A (DO Assignment bank)	Ev 1.2	37: Communication DI4 38: MANUAL mode 39: READY mode	2	
Event output 1 Output assignment B (DO Assignment bank)	Ev 1.3	40: RSP mode 41: AT running 42: During SP ramp 43: Undefined.	0	
Event output 1 Output assignment C (DO Assignment bank)	Ev 1.4	44: Alarm occurred. (AL0 1 to AL99) 45: PV alarm occurred. (AL0 1 to AL03) 46: Undefined.	0	
Event output 1 Output assignment D (DO Assignment bank)	Ev 1.5	47: mode key pressing status 48: Event output 1 status 49: Control output 1 status	0	
Event output 2 Output assignment A (DO Assignment bank)	Ev 2.2		3	
Event output 2 Output assignment B (DO Assignment bank)	Ev 2.3		0	
Event output 2 Output assignment C (DO Assignment bank)	Ev 2.4		0	

(Continue on next page.)

Chapter 5. DETAILED DESCRIPTION OF EACH FUNCTION

Item (Bank)	Display	Contents	Initial value	User level
Event output 2 Output assignment D (DO Assignment bank)	<i>Ev2.5</i>	Same as those on the previous page.	0	Same as that on the previous page.
Event output 3 Output assignment A (DO Assignment bank)	<i>Ev3.2</i>		4	
Event output 3 Output assignment B (DO Assignment bank)	<i>Ev3.3</i>		0	
Event output 3 Output assignment C (DO Assignment bank)	<i>Ev3.4</i>		0	
Event output 3 Output assignment D (DO Assignment bank)	<i>Ev3.5</i>		0	

- When the object control output is the relay output or voltage pulse output, and the operation type of the DO Assignment is set for output bit functions 1 to 4, the display and setting can be made.
- When the object event output is provided and the operation type of the DO Assignment is set for output bit functions 1 to 4, the display and setting can be made.

■ Polarity of output assignment

The polarity of four output assignments (A, B, C, D) used for the output bit function can be set.

Item (Bank)	Display	Contents	Initial value	User level
Control output 1 Polarity A to D (DO Assignment bank)	ot 1.6	The digits are called 1st digit, 2nd digit, 3rd digit, and 4th digit from the right end. 1st digit: Output assignment A Polarity setting 2nd digit: Output assignment B Polarity setting 3rd digit: Output assignment C Polarity setting 4th digit: Output assignment D Polarity setting 0: Direct 1: Reverse	0000	High function
Control output 2 Polarity A to D (DO Assignment bank)	ot 2.6		0000	
Event output 1 Polarity A to D (DO Assignment bank)	Ev 1.6		0000	
Event output 2 Polarity A to D (DO Assignment bank)	Ev 2.6		0000	
Event output 3 Polarity A to D (DO Assignment bank)	Ev 3.6		0000	

- When the object control output is the relay output or voltage pulse output, and the operation type of the DO Assignment is set for output bit functions 1 to 4, the display and setting can be made.
- When the object event output is provided and the operation type of the DO Assignment is set for output bit functions 1 to 4, the display and setting can be made.

⚠ Handling Precautions

The output relay may be turned ON and OFF repeatedly at a high-speed depending on the conditions.

To avoid such faulty operation, always strictly observe the following cautions:

Control output 1: When any of [Output assignment A, B, C, D] (ot1.2 to ot1.5) is set at [49: Control output 1 status], do not set [1: Reverse] for the same symbol of [Output assignment A, B, C, D Polarity].

Event output 1: When any of [Output assignment A, B, C, D] (Ev1.2 to Ev1.5) is set at [48: Event output 1 status], do not set [1: Reverse] for the same symbol of [Output assignment A, B, C, D Polarity].

■ Polarity of output bit function

The polarity after the output bit function (functions 1 to 4) can be set.

Item (Bank)	Display	Contents	Initial value	User level
Control output 1 Polarity (DO Assignment bank)	ot 1.7	0: Direct 1: Reverse	0	High function
Control output 2 Polarity (DO Assignment bank)	ot 2.7		0	
Event output 1 Polarity (DO Assignment bank)	Ev 1.7		0	
Event output 2 Polarity (DO Assignment bank)	Ev 2.7		0	
Event output 3 Polarity (DO Assignment bank)	Ev 3.7		0	

- When the object control output is the relay output or voltage pulse output, and the operation type of the DO Assignment is set for output bit functions 1 to 4, the display and setting can be made.
- When the object event output is provided and the operation type of the DO Assignment is set for output bit functions 1 to 4, the display and setting can be made.

■ Latch

The latch of the output ON status or output OFF status can be set.

Item (Bank)	Display	Contents	Initial value	User level
Control output 1 Latch (DO Assignment bank)	ot 1.8	0: None 1: Latched (Latched when turned ON.) 2: Latched (Latched when turned OFF except for initialization at power ON.)	0	High function
Control output 2 Latch (DO Assignment bank)	ot 2.8		0	
Event output 1 Latch (DO Assignment bank)	Ev 1.8		0	
Event output 2 Latch (DO Assignment bank)	Ev 2.8		0	
Event output 3 Latch (DO Assignment bank)	Ev 3.8		0	

- When the object control output is the relay output or voltage pulse output, and the operation type of the DO Assignment is set for output bit functions 1 to 4, the display and setting can be made.
- When the object event output is provided and the operation type of the DO Assignment is set for output bit functions 1 to 4, the display and setting can be made.
- To release the latch status, it is necessary to turn OFF the power, and turn it ON again, to release all DO latches (key operation or communication), or to change the latch setting of the DO Assignment to “0” (none).

■ DO Assignment setting with SLP-C35 Smart Loader Package

When setting [DO Assignment] with the SLP-C35 Smart Loader Package, select [Edit (E)] → [Input/Output port setup (O)] in that order from the menu. The output bit function, output assignment, polarity of output assignment, and polarity of output bit function can be easily set using visual images as shown below.

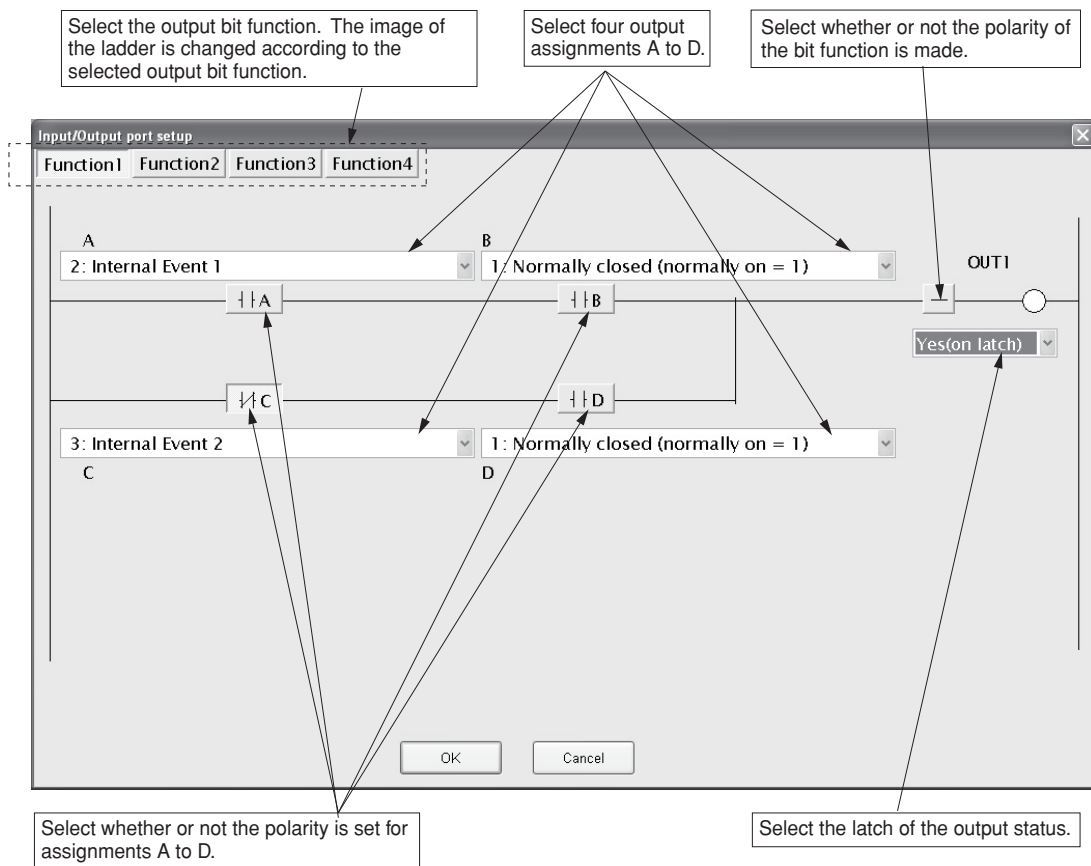

⚠ Handling Precautions

In addition to the selection through the menu, the Input port setup window can also be opened using the following procedures:

- Click the input/output port setup icon .
- Right-click in the input bit function setting window.
- Push the [P] key while pressing the [Ctrl] key.

5 - 10 Application Examples

This section describes examples of applications using the assignment functions of this unit.

■ Examples of applications using assignment functions

The following shows setting examples with the SLP-C35 Smart Loader Package. To use assignment functions, it is absolutely necessary to set the user level to “High function configuration”.

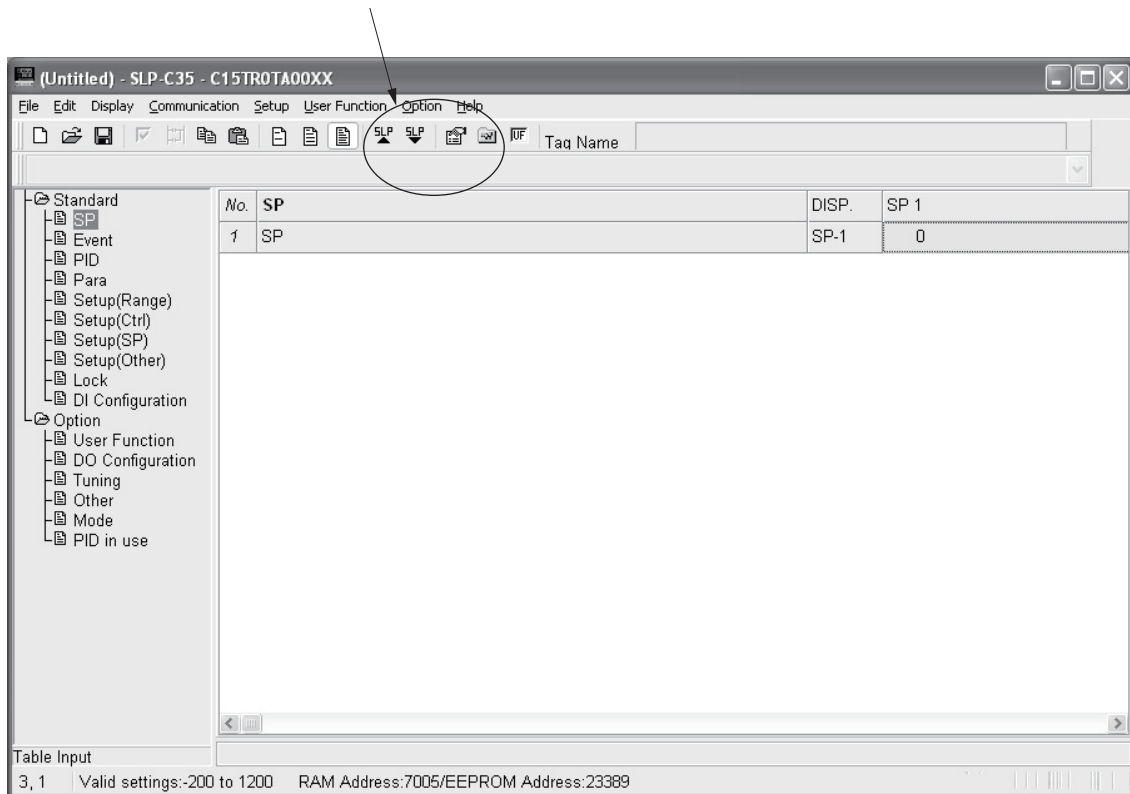

● Example 1 Logical OR of the heater burnout and PV high limit alarm is output.

Conditions: PV high limit is set to Internal Event 1.

Heater burnout is set to Internal Event 2.

Logical OR of the above events is output to the EV1 relay.

- (1) Select [Standard] → [Event] and set [Internal Event 1] to [1: PV high limit].
- (2) Similarly, set [Internal Event 2] to [16: Heater 1 break/Heater over current].
- (3) Select [Option] → [DO Assignment] and right-click on the operation type of [Event output 1] to select [Input/Output port setup].

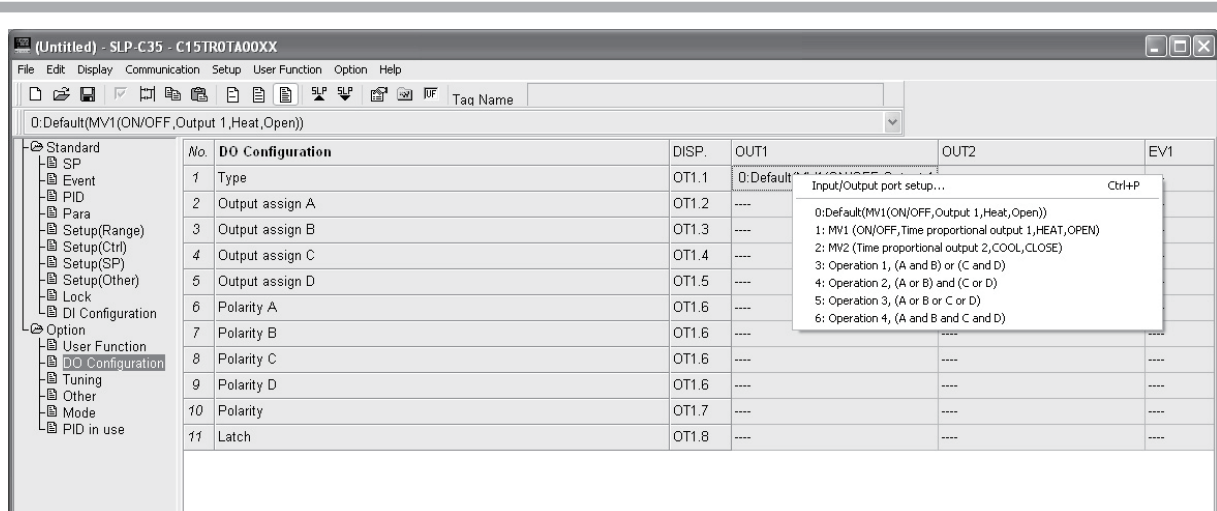

- (4) In the Input/Output port setup window, set the following items:
- (a) In this example, since the logical OR of two functions needs to be output, select [Function 1].
 - (b) Select [PV high limit] of Internal Event 1 for output assignment A.
 - (c) Similarly, select [Heater break] of Internal Event 2 for output assignment C.
 - (d) Select [Normally closed] for output assignment B and D.

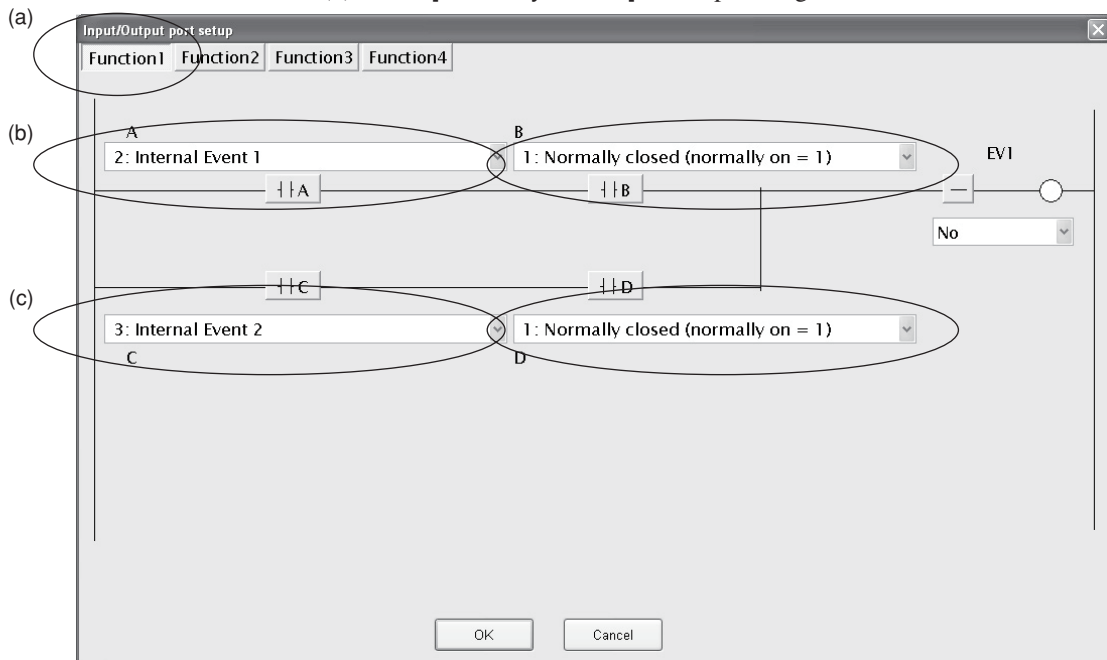

- **Example 2** The operation is started by the external switch, and then it is stopped automatically 30min after the temperature has reached the set value.

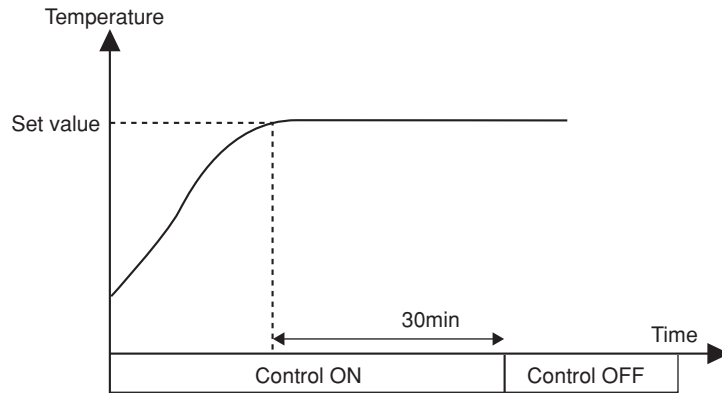

◆ **Explanation**

The timer start-up conditions are set to logical AND of DI1 and PV status EVs. The ON delay timer setting decides the time period after which the operation is stopped automatically when the temperature has reached the set value. The mode (RUN/READY) is changed based on a combination of DI1 and timer ON-OFF.

Status	Control OFF status	Timer counting after starting of operation	Operation stop by time-up
DI1	OFF	ON	ON
Timer (Internal EV2)	OFF	OFF	ON
Status of Internal Contact 2	ON	OFF	ON
Mode	READY	RUN	READY

◆ **Setting example**

• Event

Event	Display	Internal Event 1	Internal Event 2
Operation type	Ex.C1	32: Timer	4: Deviation high limit
Direct/reverse	Ex.C2	----	0: Direct
Standby	Ex.C2	----	0: No standby
EVENT state at READY	Ex.C2	0: EVENT state at READY is continued.	0: EVENT state at READY is continued.
Alarm OR	Ex.C3	0: None	0: None
Special OFF setup	Ex.C3	----	0: As usual.
Delay time unit	Ex.C3	2.1min	0: 0.1s
Event main setting (low limit)	Ex	----	0
Event sub-setting (high limit)	Ex.SB	----	----
Hysteresis	Ex.HY	----	5
ON delay	Ex.ON	30	0
OFF delay	Ex.OF	0	0

Note. The internal event No. is indicated at the mark of "x" shown in the display column.

• DI Assignment

DI Assignment	Display	Internal Contact 1	Internal Contact 2
Operation type	Dlx.1	17: Timer stop/start	7: RUN/READY
Input bit function	Dlx.2	1: Function 1 (A and B) or (C and D)	1: Function 1 (A and B) or (C and D)
Input assignment A	Dlx.3	2: DI1	2: DI1
Input assignment B	Dlx.4	11: Internal Event 2 (Setting = 4: Deviation high limit)	10: Internal Event 1 (Setting = 32: Timer (Status))
Input assignment C	Dlx.5	0: Normally opened. (Normally Off = 0)	0: Normally opened. (Normally Off = 0)
Input assignment D	Dlx.6	0: Normally opened. (Normally Off = 0)	0: Normally opened. (Normally Off = 0)
Polarity A	Dlx.7	0: Direct	0: Direct
Polarity B	Dlx.7	0: Direct	1: Reverse
Polarity C	Dlx.7	0: Direct	0: Direct
Polarity D	Dlx.7	0: Direct	0: Direct
Polarity	Dlx.8	0: Direct	1: Reverse
Event channel definitions	Dlx.9	1	----

Note. The internal DI No. is indicated at the mark of "x" shown in the display column.

◆ Setting points

The timer startup conditions are set to logical AND of DI1 and temperature attainment (Internal Event 2: Deviation high limit).

The mode (RUN/READY) selection is used as conditions for logical AND of the A contact of DI1 and the B contact of the timer. However, since the mode is the READY mode when the contact is ON, it is reversed in the final stage of internal contact 2.

DI Assignment (Internal Contact 1): Input/Output port setup

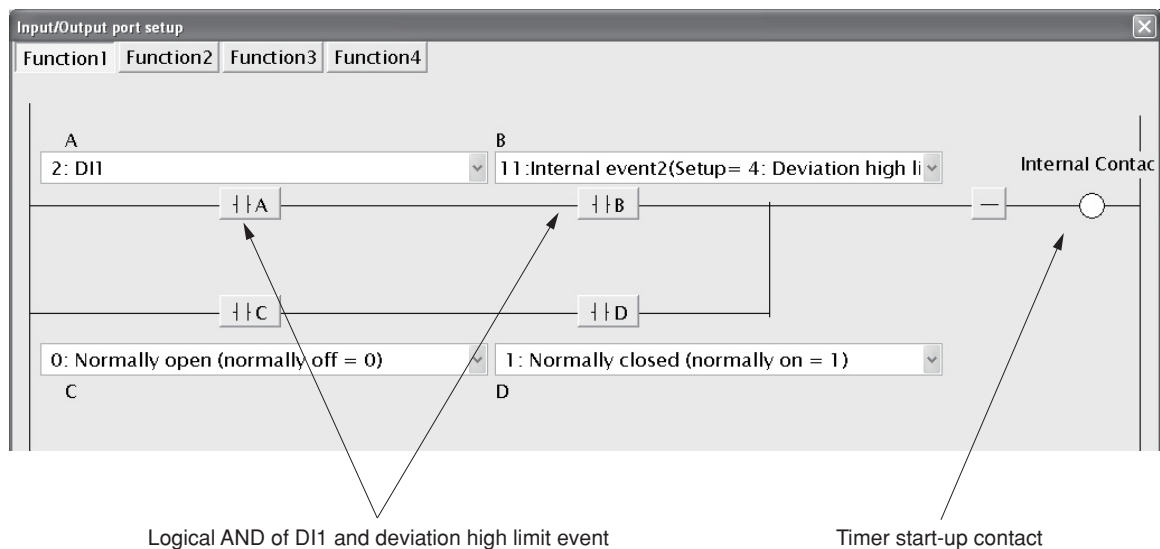

DI Assignment (Internal Contact 2): Input/Output port setup

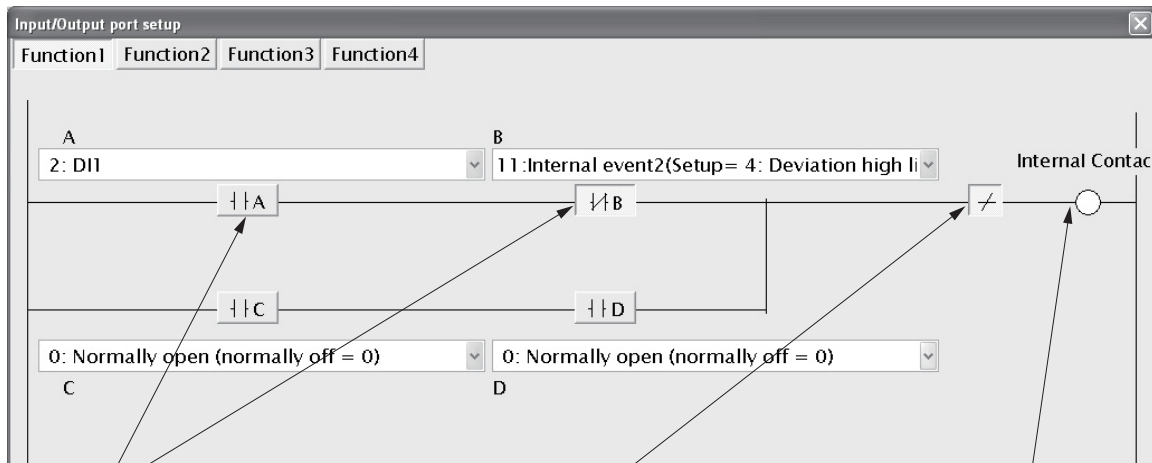

Logical AND of DI1 (A-contact) and timer (B-contact)

Reversed at this point since the mode is the READY mode when turned ON.

Mode (RUN/READY) selection contact

● Example 3 Simple pattern

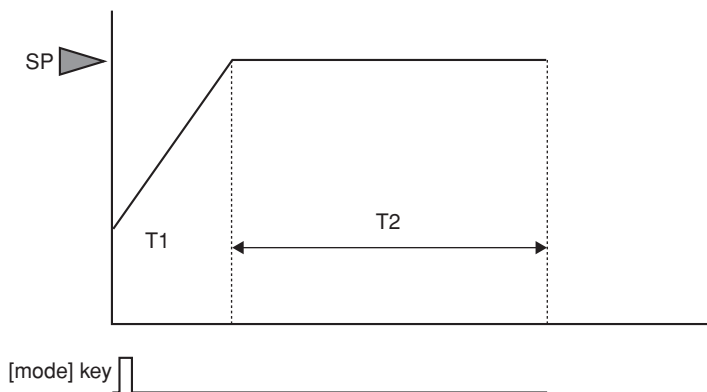

◆ Explanation

When the [mode] key is pressed, the mode is changed to the RUN mode and the PV is started.

The SP value moves up (or down) along with the ramp-up (or ramp-down) set value.

When the SP value reaches the final SP value and the PV value enters the constant range, the counting is started. After the T2 time has elapsed, the mode is changed to the READY mode.

◆ Setting example

• Event

Event	Display	Internal Event 1	Internal Event 2
Operation type	Ex.C1	9: Deviation high/low limit (Final SP reference)	32: Timer (Status)
Direct/reverse	Ex.C2	1: Reversed.	----
Standby	Ex.C2	0: No standby	----
EVENT state at READY	Ex.C2	1: EVENT state at READY is forcibly turned OFF.	0: EVENT state at READY is continued.
Alarm OR	Ex.C3	0: None	0: None
Special OFF setup	Ex.C3	0: As usual.	----
Delay time unit	Ex.C3	0: 0.1s	0: 0.1s
Event main setting (low limit)	Ex	3	----
Event sub setting (high limit)	Ex.SB	3	----
Hysteresis	Ex.HY	9999	----
ON delay	Ex.ON	2	15
OFF delay	Ex.OF	0	0

Note. The internal event No. is indicated at the mark of "x" shown in the display column.

• DI Assignment

DI Assignment	Display	Internal Contact 1	Internal Contact 2
Operation type	Dlx.1	7: RUN/READY	17: Timer stop/start
Input bit function	Dlx.2	1: Function 1 (A and B) or (C and D)	1: Function 1 (A and B) or (C and D)
Input assignment A	Dlx.3	18: COM DI 1	10: Internal Event 1 (Setting = 9: Deviation high/low limit (Final SP reference))
Input assignment B	Dlx.4	11: Internal Event 2 (Setting = 32: Timer (Status))	26: During SP ramp
Input assignment C	Dlx.5	0: Normally opened. (Normally Off = 0)	18: COM DI 1
Input assignment D	Dlx.6	0: Normally opened. (Normally Off = 0)	11: Internal Event 2 (Setting = 32: Timer (Status))
Polarity A	Dlx.7	0: Direct	0: Direct
Polarity B	Dlx.7	1: Reverse	1: Reverse
Polarity C	Dlx.7	0: Direct	0: Direct
Polarity D	Dlx.7	0: Direct	0: Direct
Polarity	Dlx.8	1: Reverse	0: Direct
Event channel definitions	Dlx.9	----	2

Note. The internal DI No. is indicated at the mark of "x" shown in the display column.

◆ Others

C72 [mode key function]: 7 (COM DI1 selection)
 SP ramp-up/ramp-down: Desired value

◆ Setting points

The internal EV1 is substituted for the guarantee soak.
 Therefore, “9999” is set to the hysteresis of Event 1 so that Event 1 is not turned OFF after it has been turned ON even though the PV fluctuates.

DI Assignment (Internal Contact 1): Input/Output port setup

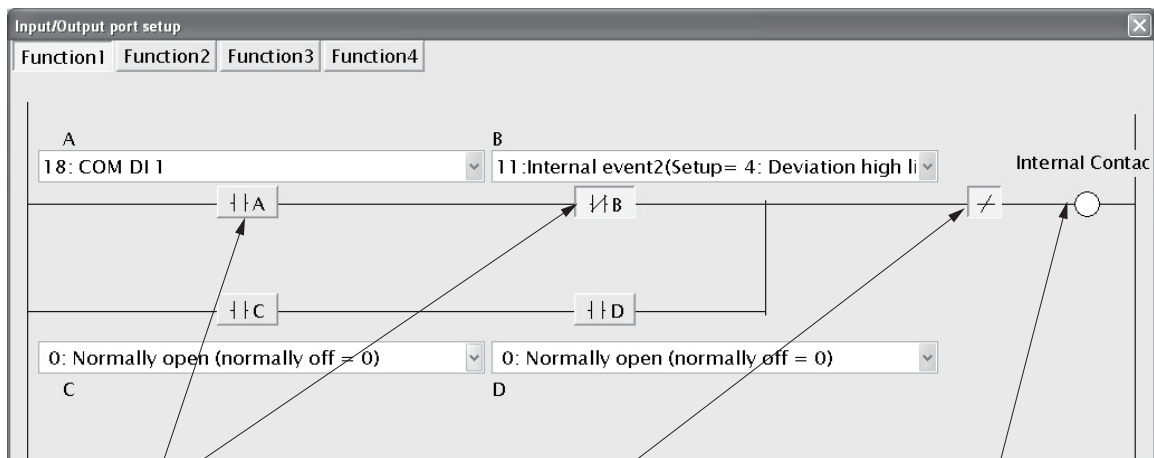

Logical AND of COM DI1 (A-contact) and timer (B-contact)

Reversed at this point since the mode is the READY mode when turned ON.

Mode (RUN/READY) selection contact

Conditions for guarantee soak (ramp is completed and operation enters within the deviation of the final SP.)

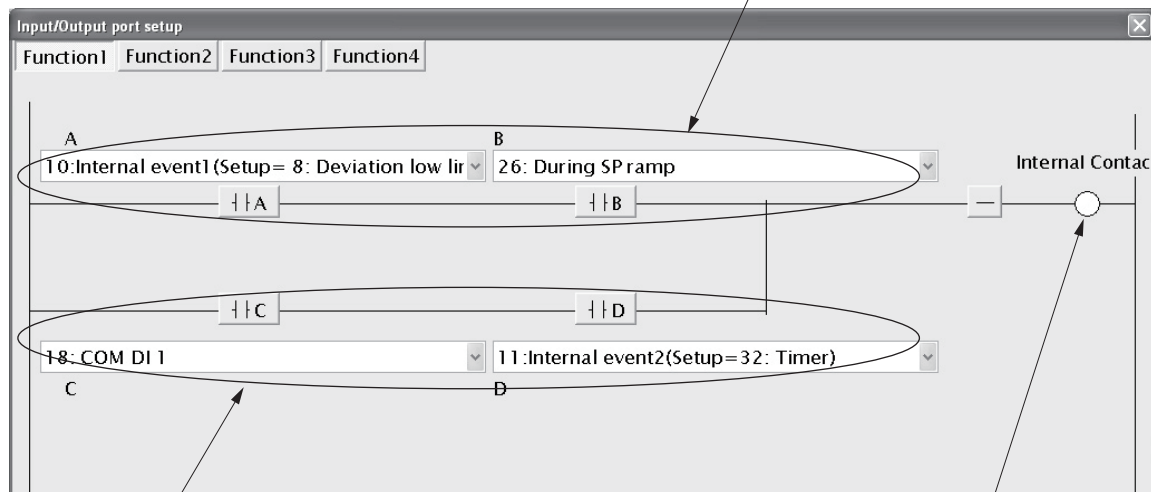

The timer start is self-retained at time-up so that the timer is not restarted due to change in PV.

Timer start-up contact

DI Assignment (Internal Contact 2): Input/Output port setup

5 - 11 Continuous Output

The following shows the functional block diagram of the continuous output:

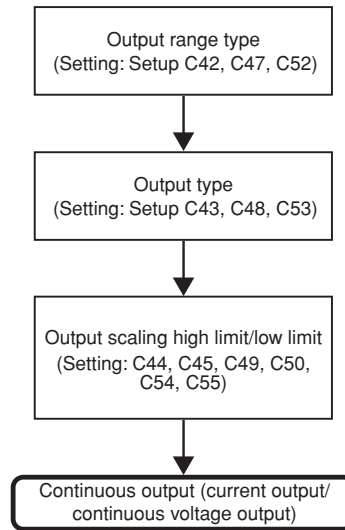

■ Output range

The output range of the current output and continuous voltage output can be set.

Item (Bank)	Display	Contents	Initial value	User level
Control output 1 range (Setup bank)	C 42	Current output 1: 4 to 20mA 2: 0 to 20mA	1	Basic, Standard, High function
Control output 2 range (Setup bank)	C 47		1	
Auxiliary output range (Setup bank)	C 52	Continuous voltage output 1: 1 to 5V 2: 0 to 5V 3: 0 to 10V	1	

- When the object control output is the current output or continuous voltage output, the display and setting can be configured.

■ Output type

The output type of the current output and continuous voltage output can be set.

Item (Bank)	Display	Contents	Initial value	User level
Control output 1 type (Setup bank)	C 43	0: Manipulated variable (MV) 1: Heat MV (for heat/cool control) 2: Cool MV (for heat/cool control) 3: PV 4: PV before ratio, bias, and filter 5: SP 6: Deviation (PV-SP) 7: CT1 current value 8: CT2 current value 9: MFB (including estimated MFB) 10: SP+MV 11: PV+MV	0	Basic, Standard, High function
Control output 2 type (Setup bank)	C 48		3	
Auxiliary output type (Setup bank)	C 53		3	

- When the object control output is the current output or continuous voltage output, the display and setting can be configured.
- MV scalable bandwidth is used to calculate SP+PV and PV+MV. For details, refer to MV scaling range (on page 5-89).
- If ROM version 1 of the instrument information bank is prior to 2.04, SP+MV and PV+MV cannot be selected.

■ Output scaling low limit/high limit

The output scaling low limit and high limit of the current output and continuous voltage output can be set.

Item (Bank)	Display	Contents	Initial value	User level
Control output 1 scaling low limit (Setup bank)	C 44	-1999 to +9999 The decimal point position may vary so that it meets the output type. The unit depend on the output type are as follows: •When the output type is 0 to 2, % of manipulated variable •When the output type is 3 to 6, same as PV(°C etc.) •When the output type is 7 and 8, ampere(current value) •When the output type is 9, % of MFB	0.0	Basic, Standard, High function
Control output 1 scaling high limit (Setup bank)	C 45		100.0	
Control output 2 scaling low limit (Setup bank)	C 49		0	
Control output 2 scaling high limit (Setup bank)	C 50		1000	
Auxiliary output scaling low limit (Setup bank)	C 54		0	
Auxiliary output scaling high limit (Setup bank)	C 55		1000	

- When the object control output is the current output or continuous voltage output, the display and setting can be configured.
- The following figures show the relationship between the numeric value and output of the output type using the output scaling low limit/high limit settings:

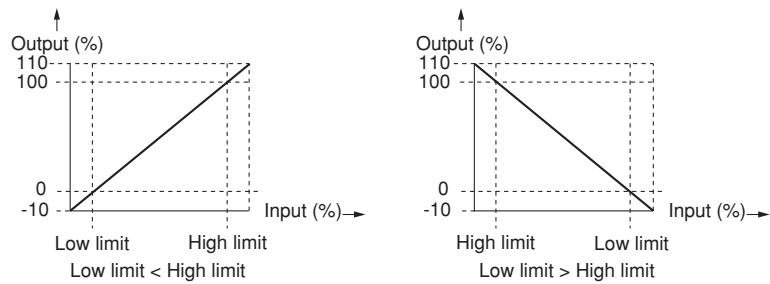

However, the output is 0 to 110% in a range of 0 to 20mA.

■ MV scaling range

When the control output type is set to either SP+MV or PV+MV, the control output is a continuous output in which the amount of change in the MV is added to the SP or PV.

Item (Bank)	Display	Contents	Initial value	User level
Control output 1 MV scaling range (Setup bank)	46	0 to 9999 The decimal point position and unit are same as those of the PV input range type.	200	Simple, Standard, High function
Control output 2 MV scaling range (Setup bank)	51		200	
Auxiliary output MV scaling range (Setup bank)	56		200	

- When the output type of control output 1, control output 2 or the auxiliary output is SP+MV or PV+MV, this item is displayed and can be set.
- The value calculated by the following formula is output according to the output scaling low/high limit settings:
 In case of SP+MV, $(MV-50.0)/100.0 \times MV \text{ scaling range} + SP$
 In case of PV+MV, $(MV-50.0)/100.0 \times MV \text{ scaling range} + PV$

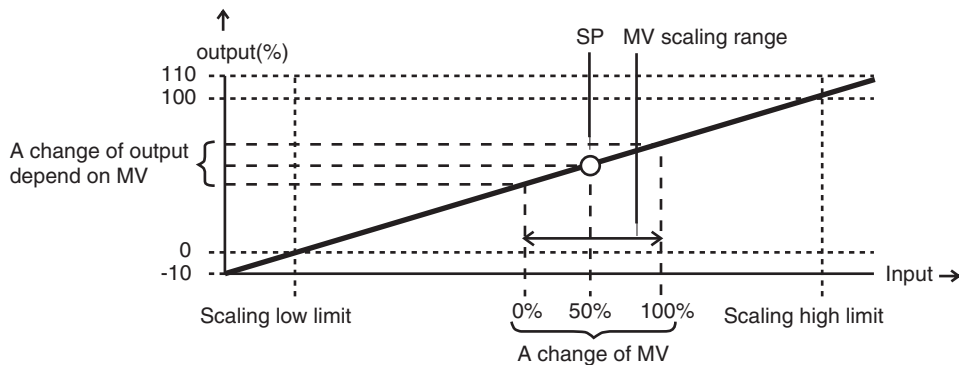

An example of the output type is SP+MV

⚠ Handling Precautions

- This function is used for cascade control when the continuous output of this controller is connected to the RSP (remote SP) of another controller, with this controller as master and the other controller as slave. Set the RSP range to MV scaling range, which changes in proportion to a change in the MV (0–100%) of this controller.
- If ROM version 1 of the instrument information bank (1.02) is prior to version 2.04, neither SP+MV nor PV+MV can be selected as an output type. The MV scaling range is not displayed and cannot be set.

5 - 12 Current Transformer (CT) Input

For CT input, two kinds of current values are provided.

- Current value at output ON: This current value is used for the heater burnout/over-current event. This current value is displayed as CT current value.
- Current value at output OFF: This current value is used for the heater short-circuit event. This current value cannot be displayed.

When [CT type] is set at “heater burnout detection” (C36 = 0 or C39 = 0), the following operation is performed: The current value at output ON becomes the CT current value measured when the output specified in [CT output] is turned ON.

The current value at output OFF becomes the CT current value measured when the output specified in [CT output] is turned OFF.

When [CT type] is set at “current value measurement” (C36 = 1 or C39 = 1), the following operation is performed: The current value at output ON becomes the measured CT current value regardless of the output ON/OFF status. The current value at output OFF is fixed at “0.0A”.

The following shows the functional block diagram of the current transformer (CT) input:

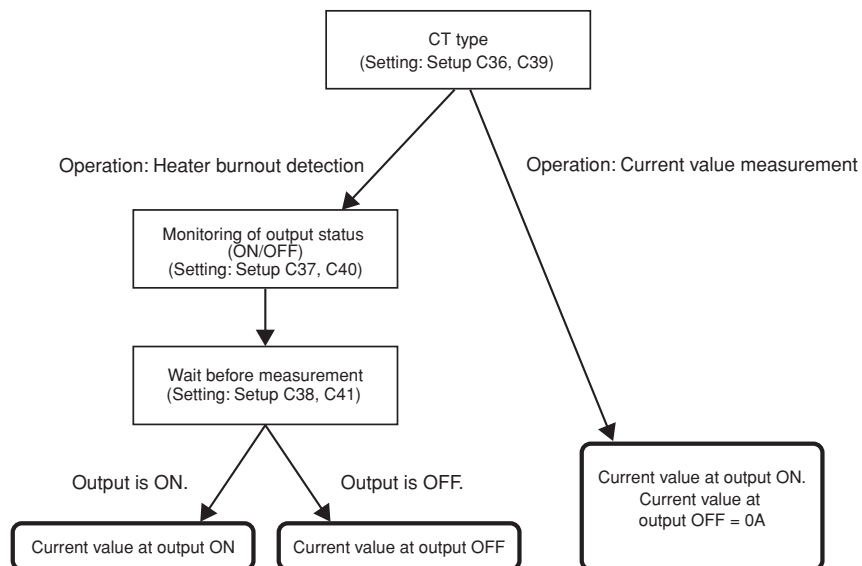

! Handling Precautions

- The current value at output ON is used when the operation type of the Internal Event is set at [heater burnout/over-current]. The current value at output OFF is used when the operation type of the Internal Event is set at [heater short-circuit].
- If a change in current value is 2.5A or less, the CT input suppresses this change through the filter process. This prevents the heater burnout event from malfunctioning due to fluctuation of the current value by variations in heater power voltage. If the heater current is 2.5A or less, the filter process is activated when this unit is powered ON or the heater is powered ON. Therefore, it takes 3 to 5s that the heater current becomes equivalent to the actual current value. When setting the heater burnout event is set at such low current level, an ON delay of 3 to 5s is set so that the event is not turned ON accidentally.

■ CT type

A desired operation type can be set for each of CT input 1 or CT input 2.

Item (Bank)	Display	Contents	Initial value	User level
CT1 operation type (Setup bank)	36	0: Heater burnout detection 1: Current value measurement	0	Basic, Standard, High function
CT2 operation type (Setup bank)	39		0	

- When the optional model has two CT input points, the display and setting can be made.
- When the CT type is set at “current value measurement”, the current value at output ON is updated regardless of the output ON/OFF status and the current value at output OFF is fixed at “0.0A”.

■ CT output

When the CT type is set at “heater burnout detection”, the output of the output ON/OFF monitor object can be set.

Item (Bank)	Display	Contents	Initial value	User level
CT1 output (Setup bank)	37	0: Control output 1 1: Control output 2 2: Event output 1 3: Event output 2 4: Event output 3	0	Basic, Standard, High function
CT2 output (Setup bank)	40		0	

- When the optional model has two CT input points and the CT type is set at “heater burnout detection”, the display and setting can be made.

■ CT measurement wait time

When the CT type is set at “heater burnout detection”, a period of time between changing of the output ON/OFF and starting of the current value measurement can be set.

Item (Bank)	Display	Contents	Initial value	User level
CT1 measurement wait time (Setup bank)	38	30 to 300ms	30ms	Basic, Standard, High function
CT2 measurement wait time (Setup bank)	41		30ms	

- When the optional model has two CT input points and the CT type is set at “heater burnout detection”, the display and setting can be made.
- When the measurement wait time has elapsed after the ON/OFF status of the output to be monitored has been changed, the measurement of the current value is started. When 100ms have elapsed after that, the measurement of the current value is completed.

■ Number of CT turns and number of CT power wire loops

Each CT of CT inputs 1 and 2 can be set.

Item (Bank)	Display	Contents	Initial value	User level
Number of CT1 turns (Setup bank)	C 90	0: 800 turns 1 to 40: CT turns divided by 100	8	High function
Number of CT1 power wire loops(Setup bank)	C 91	0: 1 times 1 to 6: Number of times	1	
Number of CT2 turns (Setup bank)	C 92	0: 800 turns 1 to 40: CT turns divided by 100	8	
Number of CT2 power wire loops(Setup bank)	C 93	0: 1 time 1 to 6: Number of times	1	

- If the controller has two CT inputs, this item is displayed and can be set.
- For the number of turns, use the number of CT turns divided by 100. For example, if the number of CT turns is 400, set at 4. (However, a setting of 0 has the same meaning as 8, namely 800 CT turns.) If using the optional QN206A or QN212A, which have 800 turns, set at 8.
- For the number of power wire loops, use the number of times the power wire passes through the CT hole. For example, if the power wire passes through the CT hole 2 times, set at 2. (However, a setting of 0 has the same meaning as 1, namely that there is 1 power wire loop).

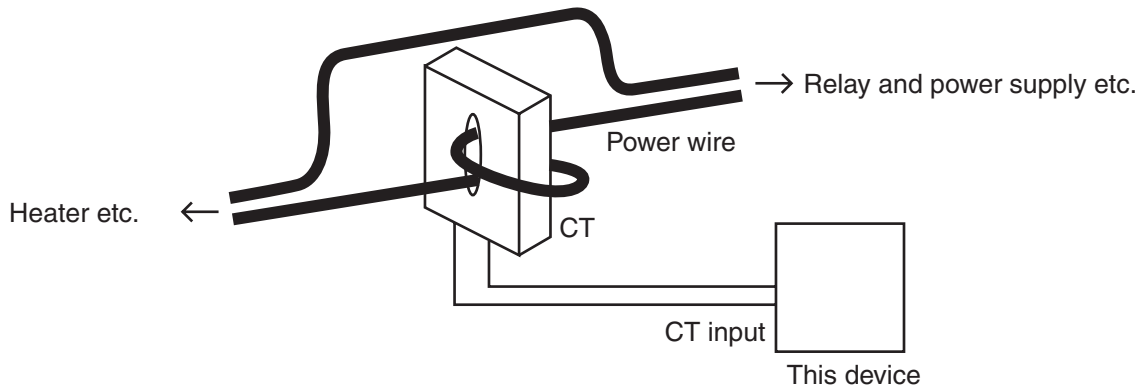

Handling Precautions

- Do not allow the current to exceed the upper limit of the CT input display range. Doing so might cause a malfunction.
- If a current exceeding the upper limit of the CT input display range is detected, the CT input failure alarm (AL11) is displayed. However, if the excessive current is very large, the CT input failure alarm is not displayed.
- The CT input display range and measurement current range change according to the number of CT turns and the number of CT power wire loops. Set for the number of CT turns and the number of CT power wire loops suitable for the conditions of the CT connected. The display range and the measurement current range are calculated by the formulas shown below. (The internal calculations of this device have an error of less than 0.1A.)

Display range lower limit (A) = 0.0

Display range upper limit (A) = Number of turns ÷ (16 x number of power wire loops) X 1.4

Measurement current range lower limit (A) = Number of turns ÷ (2000 X number of power wire loops)

Measurement current range upper limit (A) = Number of turns ÷ (16 X number of power wire loops)

The table below shows examples of how display range and measurement current range change according to the number of CT turns and the number of CT power wire loops. Measurement current range is shown in parentheses.

Number of turns \ Number of power wire loops	100 turns	400 turns	800 turns	1600 turns	4000 turns
1 time	0.0 to 8.7A (0.1 to 6.2A)	0.0 to 35.0A (0.2 to 25.0A)	0.0 to 70.0A (0.4 to 50.0A)	0.0 to 140.0A (0.8 to 100.0A)	0.0 to 350.0A (2.0 to 250.0A)
2 times	0.0 to 4.3A (0.1 to 3.1A)	0.0 to 17.5A (0.1 to 12.5A)	0.0 to 35.0A (0.2 to 25.0A)	0.0 to 70.0A (0.4 to 50.0A)	0.0 to 175.0A (1.0 to 125.0A)
6 times	0.0 to 1.4A (0.1 to 1.0A)	0.0 to 5.8A (0.1 to 4.1A)	0.0 to 11.6A (0.1 to 8.3A)	0.0 to 23.3A (0.2 to 16.6A)	0.0 to 58.3A (0.4 to 41.6A)

- If ROM version 1 of the instrument information bank (*1202*) is prior to version 2.04, the operation is always performed on the basis of 800 CT turns and one CT power wire loop. The number of CT1/CT2 turns and power wire loops is not displayed and cannot be set.
- If ROM version 1 of the instrument information bank (*1202*) is prior to version 2.04, the CT input failure alarm (AL11) is not displayed.

5 - 13 Console Display and Key Operation

It is possible to make the setting so that the console display and key operation are customized.

■ Key operation type

Two kinds of general key operation flows are provided, standard key operation type and special key operation type. A desired key operation type can be selected. (For details about two kinds of key operation types,  2-2, Key Operation (on page 2-2).)

Item (Bank)	Display	Contents	Initial value	User level
Key operation type (Setup bank)	 71	0: Standard type 1: Special type	0	High function

■ [mode] key function

The selection operation when the [mode] key is kept pressed for 1s or longer in the operation display mode can be set.

Item (Bank)	Display	Contents	Initial value	User level
[mode] key function (Setup bank)	 72	0: Invalid 1: AUTO/MANUAL selection 2: RUN/READY selection 3: AT Stop/Start 4: LSP group selection 5: Release all DO latches 6: LSP/RSP selection 7: Communication DI1 selection 8: Invalid	0	Basic, Standard, High function

Handling Precautions

- When [Ctrl: Control method] is set at “0” (ON/OFF control), the AUTO/MANUAL selection becomes invalid.
- When [Ctrl: Control method] is set at “0” (ON/OFF control) or if the PV high limit/low limit alarm occurs, the AT stop/start selection becomes invalid.
- When [C30: LSP system group] is set at “1”, the LSP group selection becomes invalid.

■ MODE display setup

The mode related setup items of the parameter setting and mode bank to be displayed can be set.

Item (Bank)	Display	Contents	Initial value	User level
MODE display setup (Setup bank)	[73	Whether or not the mode bank setup is displayed is determined by the sum of the following weights: Bit 0: AUTO/MANUAL display Disabled: 0, Enabled: +1 Bit 1: RUN/READY display Disabled: 0, Enabled: +2 Bit 2: LSP/RSP display Disabled: 0, Enabled: +4 Bit 3: AT stop/start display Disabled: 0, Enabled: +8 Bit 4: Release all DO latches display Disabled: 0, Enabled: +16 Bit 5: Communication D11 ON/OFF display Disabled: 0, Enabled: +32 Other invalid settings, 0, +64, +128	255	Standard, High function

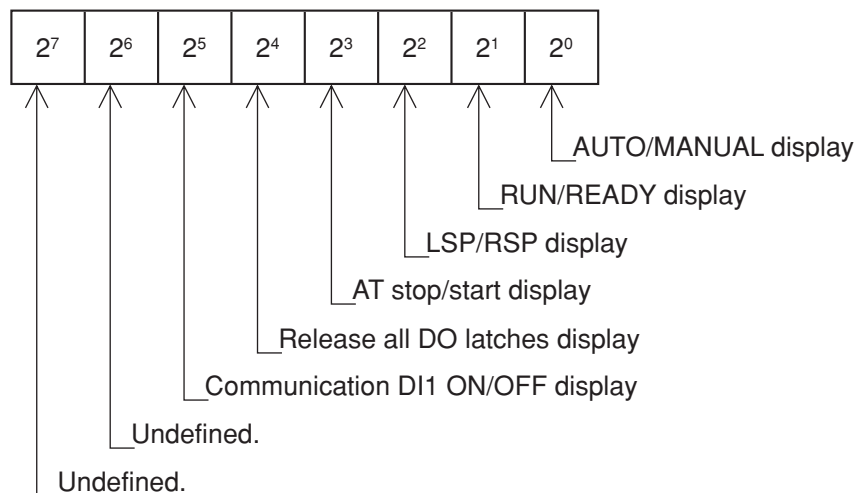

- When using the SLP-C35 Smart Loader Package, not only the numeric value, but also the bit input can be used to set [C73: MODE display setup].

⚠ Handling Precautions

- Even though the AUTO/MANUAL display is set at [Displayed], the AUTO/MANUAL is not displayed when [Ctrl: Control method] is set at "0" (ON/OFF control).
- Even though the AT stop/start display is set at [Displayed], the AT stop/start is not displayed when [Ctrl: Control method] is set at "0" (ON/OFF control).
- Even though the LSP/RSP display is set at [Enabled], the LSP/RSP is not displayed if the model does not provide the RSP input.

■ PV/SP display setup

The PV/SV value related items to be displayed in the operation display mode can be set.

Item (Bank)	Display	Contents	Initial value	User level
PV/SP display setup (Setup bank)		Whether or not the PV/SP value related items are displayed in the operation display mode is determined by the sum of the following weights: Bit 0: PV display Disabled: 0, Enabled: +1 Bit 1: SP display Disabled: 0, Enabled: +2 Bit 2: LSP group number display Disabled: 0, Enabled: +4 Other invalid settings, 0, +8	15	Standard, High function

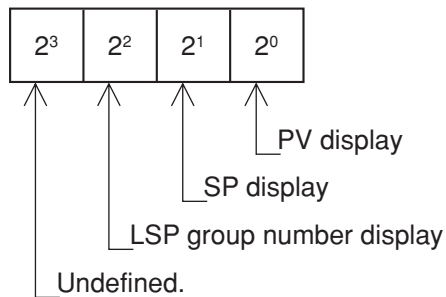

- When using the SLP-C35 Smart Loader Package, not only the numeric value, but also the bit input can be used to set [C74: PV/SP display setup].

⚠ Handling Precautions

- Even though the LSP group number display is set at [Enabled], the LSP group number is not displayed when [C30: LSP system group] is set at “1”.

■ MV display setup

The MV related items to be displayed in the operation display mode can be set.

Item (Bank)	Display	Contents	Initial value	User level
MV display setup (Setup bank)		Whether or not the MV value related items are displayed in the operation display mode is determined by the sum of the following weights: Bit 0: MV display Disabled: 0, Enabled: +1 Bit 1: Heat MV/cool MV display Disabled: 0, Enabled: +2 Bit 2: MFB display Disabled: 0, Enabled: +4 Bit 3: AT progress display Disabled: 0, Enabled: +8	15	Standard, High function

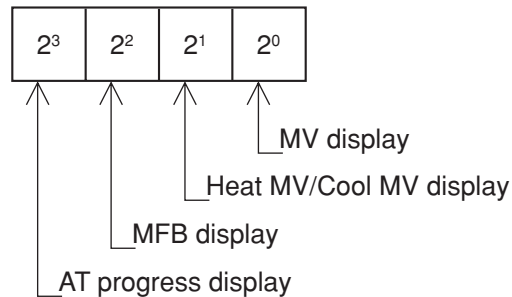

- When using the SLP-C35 Smart Loader Package, not only the numeric value, but also the bit input can be used to set [C75: MV display setup].

⚠ Handling Precautions

- Even though the heat MV/cool MV display is set at [Enabled], the heat MV/cool MV is not displayed when [Heat/Cool control: C26] is set at "0" (Disabled).
- Even though the AT progress display is set at [Enabled], the AT progress is not displayed while the AT is stopping.
- Even though the MFB display is set at [Enabled], the MFB is not displayed if the model does not provide the position proportional output.

■ EV display setup

The main setting and sub-setting of Internal Events 1 to 3 to be displayed in the operation display mode can be set.

Item (Bank)	Display	Contents	Initial value	User level
EV display setup (Setup bank)	[76	0: Internal Event set value is not displayed in the operation display mode. 1: Set value of Internal Event 1 is displayed in the operation display mode. 2: Set values of Internal Events 1 to 2 are displayed in the operation display mode. 3: Set values of Internal Events 1 to 3 are displayed in the operation display mode.	0	Standard, High function

! Handling Precautions

- Even though the Internal Event set value is set at [Enabled], the Internal Event set values are not displayed when the main setting and sub-setting are not necessary according to the operation type of Internal Event.
- The main setting and sub-setting of Internal Events 4 to 8 cannot be displayed in the operation display mode.

■ Timer remaining time display setup

The ON delay/OFF delay remaining time of Internal Events 1 to 3 to be displayed in the operation display mode can be set.

Item (Bank)	Display	Contents	Initial value	User level
Timer remaining time display setup (Setup bank)	[77	0: ON/OFF delay remaining time of Internal Event is not displayed in the operation display mode. 1: ON/OFF delay remaining time of Internal Event 1 is displayed in the operation display mode. 2: ON/OFF delay remaining time of Internal Events 1 to 2 are displayed in the operation display mode. 3: ON/OFF delay remaining time of Internal Events 1 to 3 are displayed in the operation display mode.	0	Standard, High function

! Handling Precautions

- Even though the Internal Event timer remaining time is set at [Enabled], the timer remaining time is not displayed when the timer remaining time display is not necessary according to the operation type of Internal Event.
- The timer remaining time of Internal Events 4 to 8 cannot be displayed in the operation display mode.

■ CT display setup

The CT current value to be displayed in the operation display mode can be set.

Item (Bank)	Display	Contents	Initial value	User level
CT display setup (Setup bank)		0: CT current value is not displayed in the operation display mode. 1: CT1 current value is displayed in the operation display mode. 2: CT1 to 2 current values are displayed in the operation display mode.	0	Standard, High function

- When the optional model has two CT input points, the display and setting can be made.

■ User level

The user level of the console display can be set.

As a larger value is set, the number of possible displays/settings is increased.

Item (Bank)	Display	Contents	Initial value	User level
User level (Setup bank)		0: Basic configuration 1: Standard configuration 2: High function configuration	1	Basic, Standard, High function







■ Communication monitoring display

The function of the decimal point LED at the right end digit of the lower display (lower 4-digit display) can be set.

Item (Bank)	Display	Contents	Initial value	User level
Communication monitoring display (Setup bank)		0: Disabled 1: Flashing while data is being sent through RS-485 communication. 2: Flashing while data is being received through RS-485 communication. 3: Logical OR of all DI statuses 4: Flashing in READY mode	0	High function

■ Multi Status (MS) display

The lighting conditions for the Multi Status (MS) display located at the center of the console and three groups of the lighting statuses can be set with the priority put.

Item (Bank)	Display	Contents	Initial value	User level
Multi Status (MS) display, Condition (top priority) (Setup bank)	 81	0: Normally open (Normally OFF=0) 1: Normally close (Normally ON=1) 2 to 9: Internal event 1 to 8 10 to 13: Undefined. 14: MV1 (ON/OFF, Time proportional 1, Heat-side, OPEN-side output) 15: MV2 (Time proportional 2, Cool-side, CLOSE-side output) 16 to 17: Undefined. 18 to 21: DI1 to DI4 22 to 25: Undefined. 26 to 30: Internal contact 1 to 5 31 to 33: Undefined. 34 to 37: Communication DI1 to DI4 38: MANUAL 39: READY 40: RSP 41: AT 42: During ramp 43: Undefined. 44: Alarm 45: PV alarm 46: Undefined. 47: [mode] key pressing status 48: Event output 1 terminal status 49: Control output 1 terminal status	39	High function
Multi Status (MS) display, Status (top priority) (Setup bank)	 82	0: Lit. 1: Slow flashing 2: Flashing twice 3: Fast flashing 4: Left to right 5: Right to left 6: Reciprocating between left and right 7: Deviation OK 8: Deviation graph 9: MV graph 10: Heat-side MV graph (For heat/cool control) 11: Cool-side MV graph (For heat/cool control) 12: MFB graph (including MFB being estimated) 13: DI monitor 14: Internal contact monitor 15: Internal event monitor	1	High function
Multi Status (MS) display, Condition (second priority) (Setup bank)	 83	Same as Multi Status (MS) display, Condition (top priority).	44	High function
Multi Status (MS) display, Status (second priority) (Setup bank)	 84	Same as Multi Status (MS) display, Status (top priority).	6	
Multi Status (MS) display, Condition (third priority) (Setup bank)	 85	Same as Multi Status (MS) display, Condition (top priority).	1	High function
Multi Status (MS) display, Status (third priority) (Setup bank)	 86	Same as Multi Status (MS) display, Status (top priority).	9	
Multi Status (MS) display, Deviation range (Setup bank)	 87	0 to 9999U	5U	High function

- The lighting conditions are satisfied when the status set as conditions is ON (example: Internal event 1) or the status set as conditions is met (example: MANUAL). Therefore, if the lighting conditions are set at “0”, the conditions are always not satisfied. If the lighting conditions are set at “1”, the conditions are always satisfied.
 - When the lighting conditions having the top priority are satisfied, the operation enters the lighting status having the top priority.
 - When the lighting conditions having the top priority are not satisfied and the lighting conditions having the second priority are satisfied, the operation enters the lighting status having the second priority.
 - When the lighting conditions having the top and second priorities are not satisfied and the lighting conditions having the third priority are satisfied, the operation enters the lighting status having the third priority.
 - When the lighting conditions having the top to third priorities are not satisfied, the Multi Status (MS) display becomes off.
- When the lighting status is set at “7” (deviation OK), the Multi Status (MS) display is lit or off as shown in the following Figure:
If the deviation range of the Multi Status (MS) display is set at “0U”, the Multi Status (MS) display is lit only when the PV display value equals SP (PV=SP).

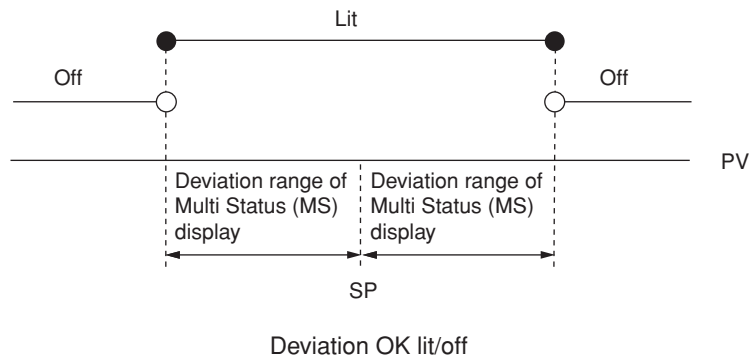

- When the lighting status is set at “8” (deviation graph), the Multi Status (MS) display is lit as shown in the following Figure:
The deviation range of the Multi Status (MS) display is set to “1U” or more. If this range is set at “0U”, the Multi Status (MS) display becomes off.

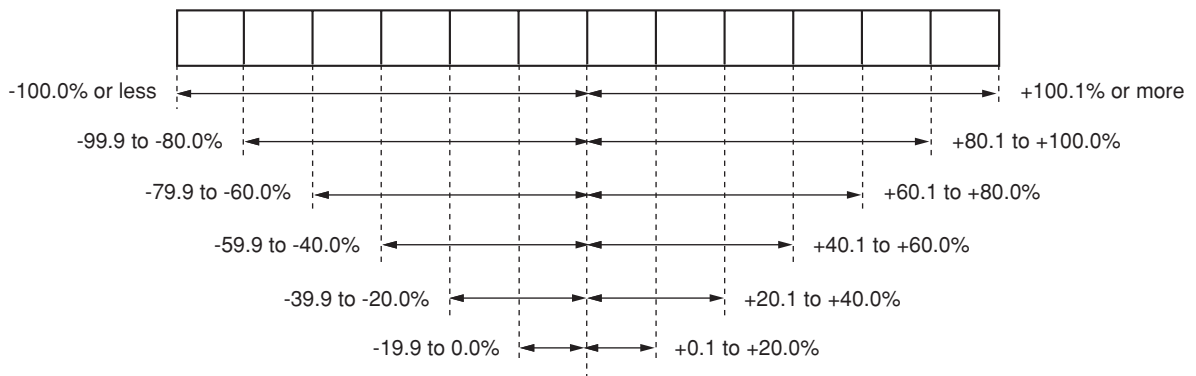

Lighting range of deviation graph (Ratio of deviation (PV-SP) to Multi Status (MS) display deviation range)

- When the lighting status is set at “9” (MV graph), “10” (Heat-side MV graph), “11” (Cool-side MV graph), or “12” (MFB graph), the Multi Status (MS) display is lit as shown in the following Figure:

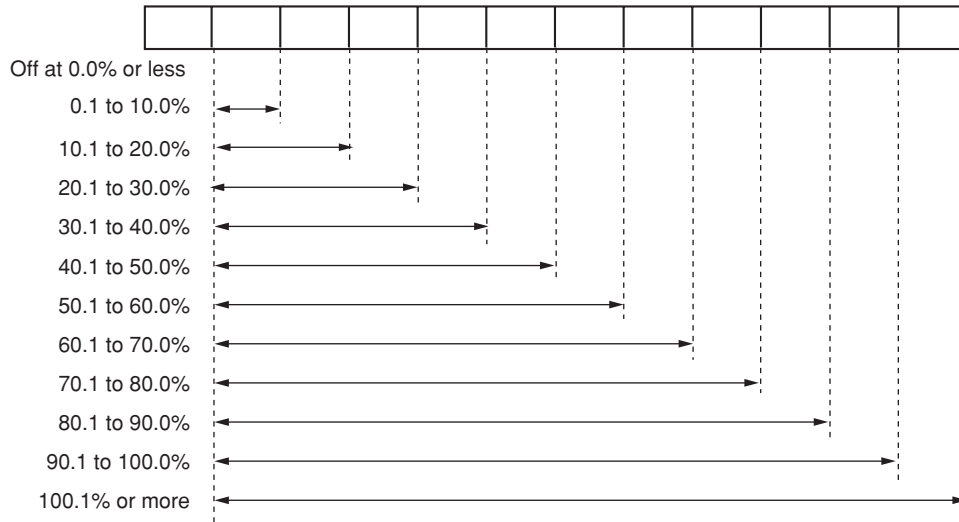

Lighting range of MV graph (This explanation also applies to the heat MV, cool MV, and MFB.)

- When the lighting status is set at “13” (DI monitor), “14” (Internal contact monitor), or “15” (Internal event monitor), the Multi Status (MS) display is lit as shown in the following Figure:

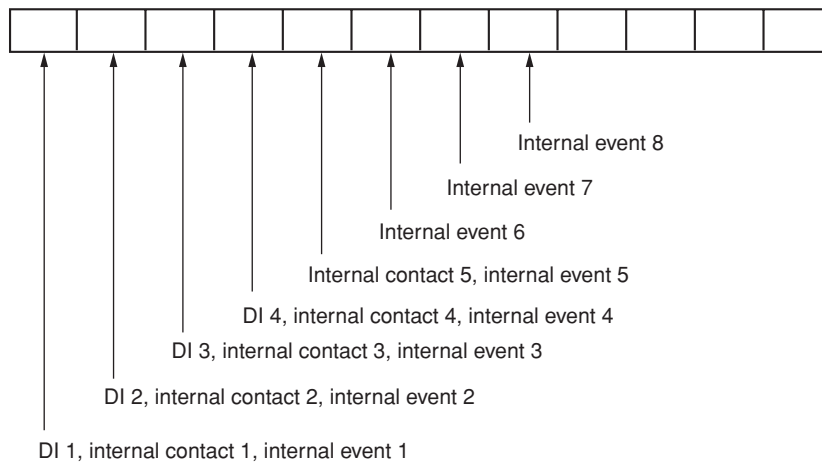

Lighting of DI, internal contact, and internal event

■ User Function

Up to eight settings selected from various settings can be added to the operation display.

Item (Bank)	Display	Contents	Initial value	User level
User Function 1 (User Function bank)	UF-1	Each setting is set on the upper display. The following shows the setting exceptions: ---- : Not registered.	----	Standard, High function
User Function 2 (User Function bank)	UF-2	P- : Proportional band of currently used PID group I- : Integral time of currently used PID group	----	
User Function 3 (User Function bank)	UF-3	d- : Derivative time of currently used PID group rE- : Manual reset of currently used PID group	----	
User Function 4 (User Function bank)	UF-4	oL- : Output low limit of currently used PID oH- : Output high limit of currently used PID group	----	
User Function 5 (User Function bank)	UF-5	P- ϵ : Proportional band for cool side of currently used PID group I- ϵ : Integration time for cool side of currently used PID group	----	
User Function 6 (User Function bank)	UF-6	d- ϵ : Derivative time for cool side of currently used PID group oL- ϵ : Output low limit for cool side of currently used PID group	----	
User Function 7 (User Function bank)	UF-7	oH- ϵ : Output high limit for cool side of currently used PID group	----	
User Function 8 (User Function bank)	UF-8		----	

- Only settings which can be displayed can be registered. (For example, manual reset of the PID constant can be registered only if integral time (I) is set at 0.)
- Setting cannot be made from the console by using a parameter number displayed on the setup screen of the SLP-C35 Smart Loader Package.
- The following keys can be used to select a parameter to be set:
 - [<] key: Moves to the top parameter of the next parameter bank.
 - [v] key: Displays the next parameter.
 - [^] key: Displays the previous parameter.
 - [enter] key: Executes the start and confirmation of a setting change.
- When using the SLP-C35 Smart Loader Package, [User Function] can be registered even though the conditions for instrument status are set as display disabled.

Handling Precautions

Settings registered as user functions are displayed as if the user level is High function, in spite of the actual user level setting in setup C79. Otherwise the display is according to the C79 setting.

● **User Function setting procedures**

This section describes an example of setting with the Smart Loader Package SLP-C35.

When registering the user function, up to eight parameters can be registered to the [para] key.

When frequently used functions are registered, this ensures convenient operation. In this example, the main setting of event 1 is registered into UF1.

1. To register a user function from the user function item:

When using this function, first set the user level to “Standard configuration” or “High function configuration”.

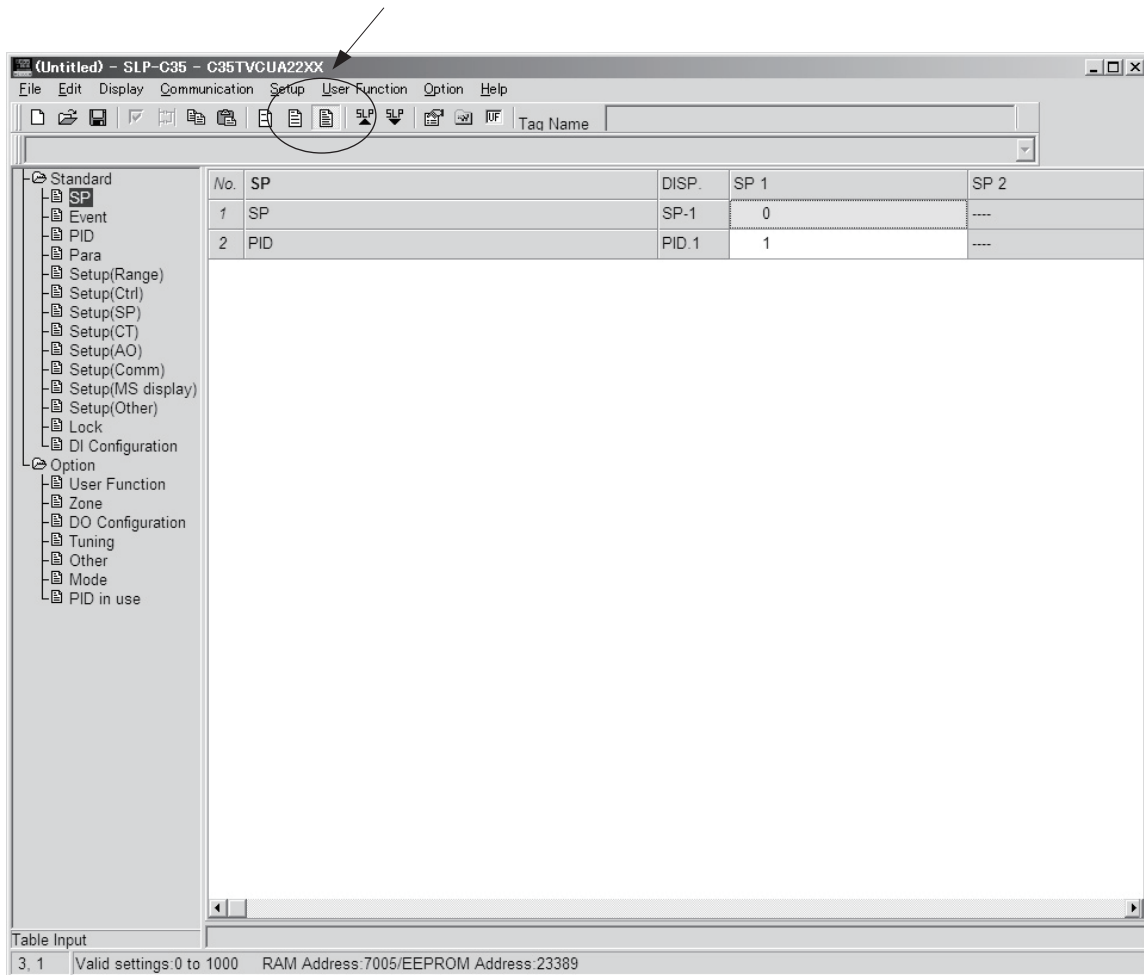

- (1) Select [Option] → [User Function].
- (2) Select [1: Event] in [Group select].
- (3) Select [801: Event value] in [Item select].

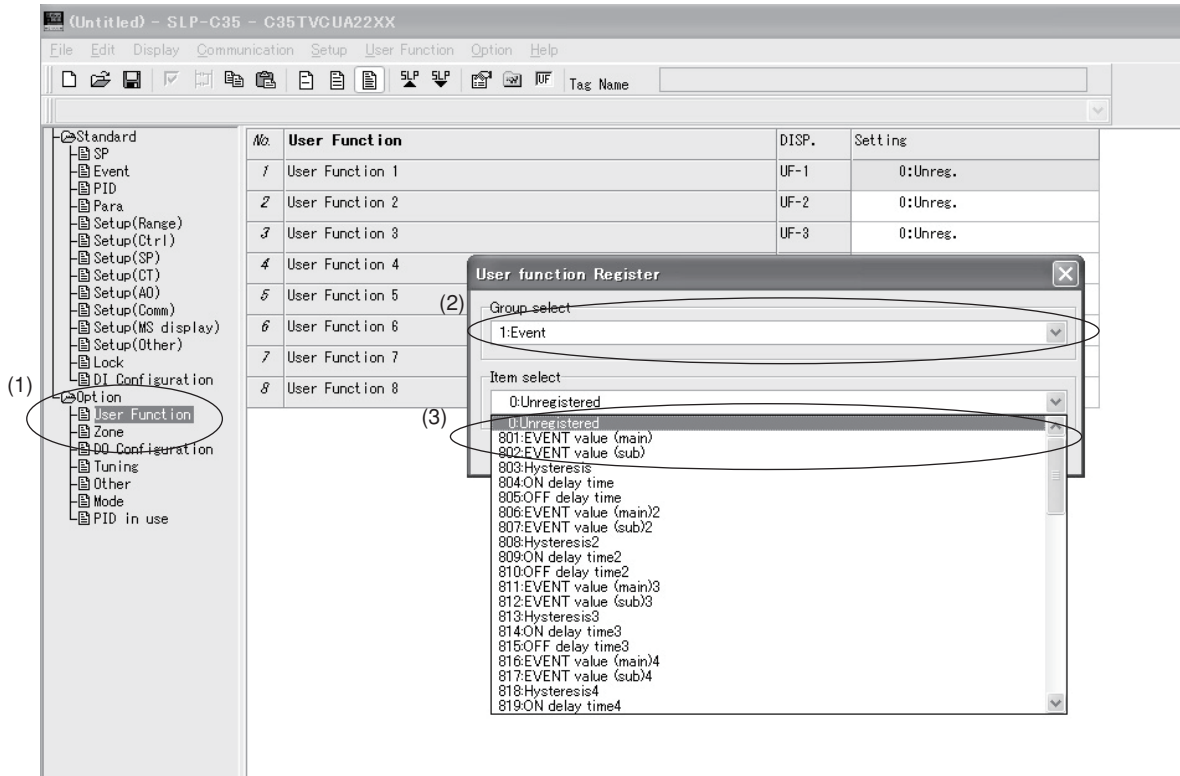

2. To register currently setting item into the user function:

If there are any parameters you wish to register into the user function during setting, follow the steps below to register such parameters.

(1) Keep the cursor placed in an item you wish to register and set, and then left-click the [UF] icon.

>> The user function register box will appear.

(2) Check on Nos. you wish to register and click [Register].

>> Items you have checked on are then registered.

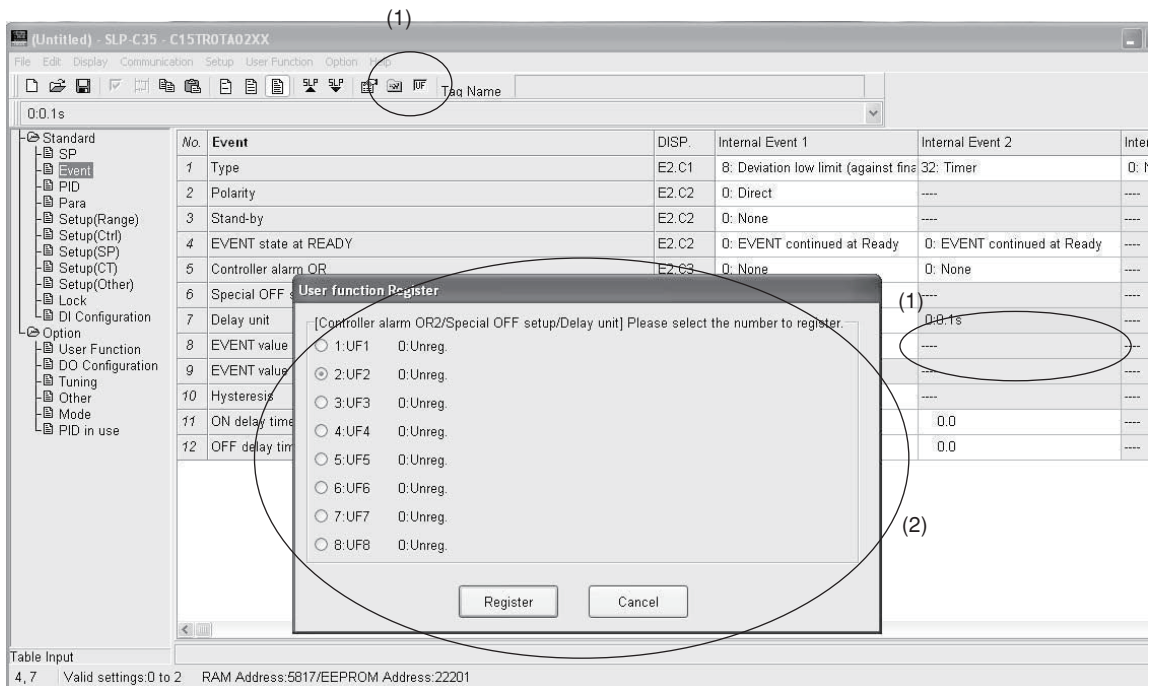

Note

The registered contents can also be checked by selecting [Option] → [User Function].

■ **Key lock, communications lock, and loader lock**

The setting (changing) or display can be set disabled using the key lock.

Item (Bank)	Display	Contents	Initial value	User level
Key lock (Lock bank)	LoL	0: All settings are possible. 1: Mode, event, operation display, SP, UF, lock, manual MV, and mode key can be set. 2: Operation display, SP, UF, lock, manual MV, and mode key can be set. 3: UF, lock, manual MV, and mode key can be set.	0	Basic, Standard, High function
Communications lock (Lock bank)	CLoL	0: RS-485 communications read/write enabled. 1: RS-485 communications read/write disabled. *	0	High function
Loader lock (Lock bank)	LLoL	0: Loader communications read/write enabled. 1: Loader communications read/write disabled. *	0	High function

Communications can be disabled by using the communications lock and loader lock.

- When using only the key lock setting, key lock objects can be displayed, but the setting (changing) cannot be configured.
- When locked with the password, the display and setting of key lock objects cannot be configured.

* Even with a communications lock or loader lock, read/write of the parameters below is possible.

Bank	Item
Setup	Decimal point position
SP	RSP
Mode	AUTO/MANUAL
	RUN/READY
	LSP/RSP
	AT stop/start
	Release all DO latches
Operation display	PV
	SP (Target value)
	LSP group selection
	PID group being selected.
	Manipulated Variable (MV)
	Heat Manipulated Variable (Heat MV)
	Cool Manipulated Variable (Cool MV)
	Motor opening feedback value (MFB)
AT progress	

Bank	Item
Operation display	Current transformer (CT) current value 1
	Current transformer (CT) current value 2
	Timer remaining time 1
	Timer remaining time 2
	Timer remaining time 3
	Timer remaining time 4
	Timer remaining time 5
	Timer remaining time 6
	Timer remaining time 7
	Timer remaining time 8
	STEP operation No.
	STEP operation remaining time
	STEP operation remaining time (sec.)
	LSP value in use
PV before ratio, bias, and filter	
RSP before ratio, bias, and filter	
Status	Input alarm status

■ Password

The setting (changing) of the key lock, communication lock, and loader lock can be set disabled using the password.

Item (Bank)	Display	Contents	Initial value	User level
Password display (Lock bank)	PASS	0 to 15 5: Password 1A to 2B display	0 (The initial value becomes "0" when the power is turned ON.)	Basic, Standard, High function
Password 1A (Lock bank)	PS1A	0000 to FFFF (Hexadecimal value)	0000	Basic, Standard, High function
Password 2A (Lock bank)	PS2A	0000 to FFFF (Hexadecimal value)	0000	
Password 1B (Lock bank)	PS1b	0000 to FFFF (Hexadecimal value)	0000	
Password 2B (Lock bank)	PS2b	0000 to FFFF (Hexadecimal value)	0000	

- When using only the key lock setting, the display can be made, but the setting (changing) cannot be made.
- When locked with the password, the display and setting cannot be made.
- The display and setting of [Password 1A: PS1A] and [Password 2A: PS2A] can be made only when [Password display: PASS] is "5" and the passwords of two groups (1A and 1B, 2A and 2B) are matched.
- The display and setting of [Password1B: PS1b] and [Password 2B: PS2b] can be made only when [Password display: PASS] is "5".
- The value set in [Password1A: PS1A] is automatically set to [Password1B: PS1b].
- The value set in [Password2A: PS2A] is automatically set to [Password2B: PS2b].

! Handling Precautions

- Before setting the passwords 1A to 2B, determine two hexadecimal values to be used as passwords and make a note of them for future reference.
- [PASS] is used to prevent incorrect password setting by limiting the display conditions of passwords 1A to 2B.
- When other values are set for passwords 1B and 2B after the values to be used as passwords have been set for passwords 1A and 2A, the passwords 1A and 2A cannot be displayed and the key lock, communication lock and loader lock cannot be changed. This status is called "password lock status".
- The settings, which cannot be changed by the key lock, cannot be displayed in the password lock mode.
- If the password lock cannot be unlocked, contact the azbil Group or its dealer. At Azbil Corporation's factory, the password lock can be unlocked by returning the setting to the initial setting. In this case, note that the data, which has been set by the customer, cannot be saved (retained).

5 - 14 Position Proportional Control

When the control output type of the model is R1 (motor drive relay output), the position proportional control is performed. In the position proportional control, the ON/OFF control of the relays on the open and close sides is performed so that the MV (manipulated variable) by the PID control, MANUAL operation, and output at READY meets the opening (MFB) of the motor.

■ Position proportional type

Item (Bank)	Display	Contents	Initial value	User level
Position proportional type (Setup bank)	 57	0: MFB control and Estimated position control 1: MFB control 2: Estimated position control (MFB disabled) 3: Estimated position control (MFB disabled) + Position adjustment at power ON.	0	Basic, Standard, High function

- On position proportional control models (with code R1 in the control output segment of the model No.), the factory setting for At-d (AT derivative time adjustment coefficient) in the Extended tuning bank is 0.00, and therefore the derivative time is 0 seconds when AT is complete. To have the AT result affect control, change the At-d setting to 1.00 and re-execute AT. For details,  ■ Auto turning (AT) (on page 5-26).
- When the control output type is R1 (motor drive relay output), the Heat/Cool control is not enabled.
- When the control output type is R1 (motor drive relay output), the display and setting can be performed.
- In case of the position proportional control model, the Heat/Cool control is not enabled.

Handling Precautions

- When [C57: Position proportional type] is set to [0: MFB control + Estimated position control] or [1: MFB control], set [C60: Motor auto adjust] to [1: Start] and execute the motor auto adjust. For details,  ■ Motor auto adjust (on page 5-111).
When [C57: Position proportional type] is set to [2: Estimated position control (MFB disabled)] or [3: Estimated position control (MFB disabled) + Position adjustment at power ON], set the precise value to [C63: Motor full close-full open time].

● Setting 0 (MFB control + Estimated position control)

When the Motor Feed Back (MFB) input is correct, the motor position is controlled by actually measured MFB.

When using this setting, the setup (C60) is set at “1” to perform the motor auto adjust.

- If the MFB input is faulty, the motor position is controlled by the estimated MFB value. This status is called “estimated position control status”.
For example, if the motor is rotated to the position where the feedback potentiometer deteriorates, the MFB input is changed rapidly.
This rapid change is detected as error to estimate the correct MFB position. Additionally, if the MFB burnout alarm occurs, the motor position is also controlled by the estimated MFB value.

- In the estimated position control status, an error occurs between the actual motor opening and estimated MFB value.

Therefore, if the output (MV) $\leq 0.0\%$, the relay on the close side is always turned ON. If the output (MV) $\geq 100.0\%$, the relay on the open side is always turned ON.

According to the above control, the motor is put in the fully closed status or fully opened status to correct the error.

However, the error is not corrected if the MV value is limited to a range of 0.1 to 99.9% by the output limiter or if the MV value does not become 0.0% or less or 100% or more according to the control status.

- The following may be the cause if the estimated position control is activated easily.
 - The motor opening is adjusted incorrectly.
 - The feedback potentiometer deteriorates or the resolution is insufficient.
 - The MFB wiring is faulty.

● **Setting 1 (MFB control)**

The motor is controlled by actually measured MFB. If the MFB burnout alarm (AL07) occurs, the MFB is changed to “150%” so that the relay on the close side is always turned ON. When using this setting, the setup (C60) is set at “1” to perform the motor auto adjust.

● **Setting 2 (Estimated position control)**

- The motor is always controlled in the estimated position control status. Regardless of the presence of the MFB wiring, the motor position is controlled by the estimated MFB value.
- When using this setting, [C63: Motor full close-full open time] must be input correctly.
- The MFB burnout alarm does not occur.
- The error between the actual motor opening and estimated MFB value is corrected by forcibly moving the motor continuously in the close or open direction when the MV is 0.0% or 100%.

● **Setting 3 (Estimated position control + Position adjustment at power ON)**

When the power is turned ON, the relay on the close side is kept turned ON for a period of time set in [C63: Motor full close-full open time] to make “0%” of the estimated MFB matched with the motor opening. Subsequent operation is the same as that described for setting 2 (Estimated position control).

When using Setting 3, set the precise value to [C63: Motor full close–full open time].

■ Position proportional deadband

Item (Bank)	Display	Contents	Initial value	User level
Position proportional deadband (Setup bank)		0.5 to 25.0%	10.0%	Basic, Standard, High function

- When the control output type is R1 (motor drive relay output), the display and setting can be performed. However, if [C59: Motor long life mode] is set at “1” (aiming at the service life of the potentiometer), the display and setting cannot be performed.

The deadband between the motor open and motor close in the position proportional control is set.

For setting reference, this deadband is changed when the manual output is output at a constant rate. The value, which is obtained when the hunting of the motor is stopped, is the minimum value of the deadband.

If the exactly minimum value is set, the motor is always moved, causing the service life of the motor to be shortened extremely.

The default setting before shipment is “10.0%”. With this default value used as reference value, the setting is made correctly by taking the control results and service life of the motor into consideration.

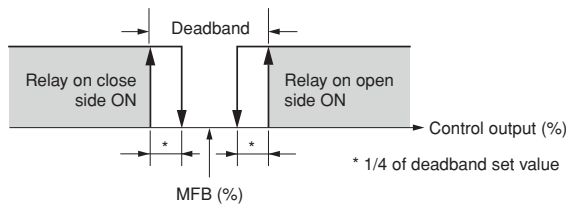

■ Motor long life mode

Item (Bank)	Display	Contents	Initial value	User level
Motor long life mode (Setup bank)		0: Aiming at controllability 1: Aiming at service life of potentiometer	1	Basic, Standard, High function

- When the control output type is R1 (motor drive relay output), the display and setting can be performed.
- When this setting is set at “1” (aiming at service life of potentiometer), the values set in [oUtL: Output variation limit] and [C58: Position proportional deadband] become invalid and the value suitable for aiming at the service life of the potentiometer is calculated automatically.

■ Motor auto adjust

Item (Bank)	Display	Contents	Initial value	User level
Motor auto adjust (Setup bank)		0: Stop 1: Start	0	Basic, Standard, High function

⚠ Handling Precautions

When [C57: Position proportional type] is set at “0” or “1,” be sure to perform [C60: Motor auto adjust].

- When the control output type is R1 (motor drive relay output), the display and setting can be performed. However, when [C57: Position proportional type] is set at “2” (Estimated position control) or “3” (Estimated position control + Position adjustment at power ON), the display and setting cannot be performed.
- When using the motor auto adjust function of the position proportional control, [C61: Input with motor fully closed], [C62: Input with motor fully open], and [C63: Motor full close-full open time] are set automatically.
- Motor auto adjusting procedures
 1. Set “0” or “1” to [C57: Position proportional type].
 2. Set “1” to [C60: Motor auto adjust] and press the [enter] key.
When this setup (C60) is already set at “1”, press the [enter] key twice.
 3. The motor auto adjust is then started.
 - The upper display shows \overline{REL} and the relay on the close side is turned ON.
 - The motor is moved toward the close side and the MFB count value is shown on the lower display. When the counting becomes stable, the fully closed adjustment is completed. This count value is then written into [C61: Input with motor fully closed].
 - The upper display shows \overline{ROP} and the relay on the open side is turned ON.
 - The motor is moved toward the open side and the MFB count value is shown on the lower display. When the counting becomes stable, the fully open adjustment is completed. This count value is then written into [C62: Input with motor fully open]. Additionally, a period of time, which has elapsed from the fully closed position to the fully open position, is written into [C63: Motor full close-full open time].
 - When the motor auto adjust has been completed, the basic display screen will appear.
 4. To cancel the adjustment, press the [display] key.
When the motor auto adjust is started, keys other than the [display] key used to cancel the adjustment cannot be operated.
If any of the following arises, each value is returned to its default setting before shipment and “AL10” is shown as the troubleshooting process.
“AL10” is cleared only when the motor auto adjust is restarted and completed correctly or when the power is reset.
 - The count value between the fully closed position and fully open position is less than “260”.
 - The fully closed count is greater than the fully open count.
 - The period of time from the fully closed position to the fully open position is less than 5s or 240.0s or more.
 - The MFB burnout alarm (AL07) is continued or occurs frequently.
 - The period of time that the MFB count value becomes stable exceeds 5min.
 - The MFB or open/close relay has faulty wiring.
(However, all of faulty wiring cannot be detected as error.)
- As the data is written into the motor auto adjust (decimal address: 5260) through the CPL or Modbus communication, the starting of the motor auto adjust can be cancelled. To start the motor auto adjust, “1” is written. On the contrary, to cancel the motor auto adjust, “0” is written.

Handling Precautions

- If the power to the measuring instrument is turned OFF during motor auto adjust of the position proportional control, the motor auto adjust is cancelled when the power is turned ON again.
- Even though the AUTO/MANUAL mode, RUN/READY mode, or LSP/RSP is changed during motor auto adjust, the motor auto adjust is continued.

■ Motor wiring and motor auto adjust operation

For wiring method between the motor and controller, two kinds of wiring methods, direct wiring and reverse wiring, are provided as described below. The direct wiring means that the motor is rotated clockwise (CW, ↻) as the output of the controller increases.

If it is required to rotate the motor counterclockwise according to the control contents, such as cooling control, two kinds of methods are provided as described below.

- The wiring is not changed and the control action direction is changed on the controller side.
- The wiring is changed to construct the reverse wiring.

In this unit, the control action (Direct/Reverse) can be changed.

If the direct wiring is used for the wiring to the motor, the thinking way of each control is simplified and the trouble can be solved easily.

Therefore, it is recommended to perform the direct wiring where possible.

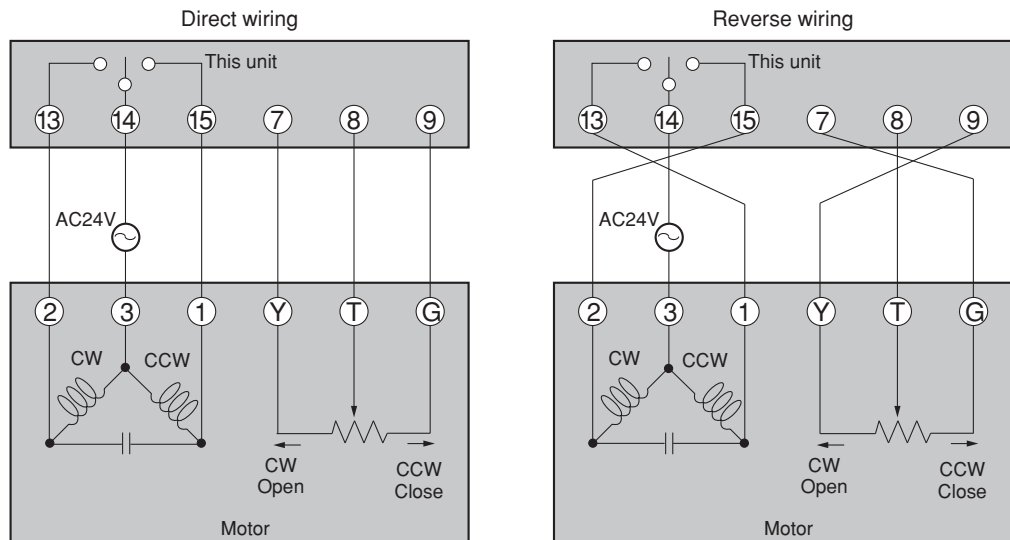

CW: Clock Wise (Clockwise, ↻)

CCW: Counter Clock Wise (Counterclockwise, ↻)

This unit has functions (AL07, AL10) that detect incorrect wiring with the motor and the MFB burnout or short-circuit.

In the same manner as described for the direct wiring, the unit judges the reverse wiring as correct and does not give any alarm.

Additionally, when [C57: Position proportional type] is set at [0: MFB control + estimated position control], the operation continues even though the MFB burnout is detected.

The following Tables summarize symptoms of each wiring method during motor auto adjust ([C60: Motor auto adjust] is set at [1: Start]).

At this time, note that the motor is started from the fully closed position (position where the motor rotated counterclockwise fully). Numeric values shown in the lower display column of the Tables show examples. The lit LED column in the Tables shows examples with initial values of the DO Assignment, that is, control output 1 uses the open side and control output 2 uses the close side. Additionally, the alarm is shown after the motor has been closed or opened fully.

● Correct direct wiring

Upper display	Lit LED	Lower display	Motor motion	Notes
\overline{RCL}	ot2	Decreases like 2000 → 1500 and becomes stable.	CCW	When the motor is moved CCW with "ot2" lit, the motor terminals 1 and 2 are the direct wiring.
↓ \overline{Rop}	ot1	Increases like 1500 → 3500 and becomes stable.	CW	



● Correct reverse wiring

Upper display	Lit LED	Lower display	Motor motion	Notes
\overline{RCL}	ot2	Decreases like 3500 → 1500 and becomes stable.	CW	When the motor is moved CW with 1 and 2 connected reversely, G and Y connected reversely, and "ot2" lit, the motor terminals 1 and 2 are the reverse wiring.
↓ \overline{Rop}	ot1	Increases like 1500 → 3500 and becomes stable.	CCW	

● Alarm indications and causes due to incorrect wiring

Upper display	Lit LED	Lower display	Motor motion	Alarm indication	Cause
\overline{RCL}	ot2	Increases and becomes stable.	CCW	$RL \neq 0$	G and Y are connected reversely.
↓ \overline{Rop}	ot1	Decreases and becomes stable.	CW		
\overline{RCL}	ot2	Decreases and becomes stable.	CCW	None. However, the MFB value does not meet the motor opening.	T and G are connected reversely.
↓ \overline{Rop}	ot1	Increases and becomes stable.	CW		
\overline{RCL}	ot2	Decrease or increase is unclear. (Motor motion is changed before fully closed or opened.)	CCW	$RL \neq 0$ or none.	T and Y are connected reversely.
↓ \overline{Rop}	ot1		CW		
\overline{RCL}	ot2	Increases and becomes stable.	CW	$RL \neq 0$	1 and 2 are connected reversely.
↓ \overline{Rop}	ot1	Decreases and becomes stable.	CCW		
\overline{RCL}	ot2	Increases and becomes stable.	CW	$RL \neq 0$	1 and 2 are connected reversely; T and G are connected reversely.
↓ \overline{Rop}	ot1		Decreases and becomes stable.		
\overline{RCL}	ot2	Decrease or increase is unclear. (Motor motion is changed before fully closed or opened.)	CW	$RL \neq 0$ or none.	1 and 2 are connected reversely; T and Y are connected reversely.
↓ \overline{Rop}	ot1		CCW		

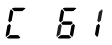
■ Input with motor fully closed and input with motor fully open

Item (Bank)	Display	Contents	Initial value	User level
Input with motor fully closed (Setup bank)		0 to 9999	1000	Basic, Standard, High function
Input with motor fully closed (Setup bank)		0 to 9999	3000	

- When the control output type is R1 (motor drive relay output), the display and setting can be performed. However, if [C57: Position proportional type] is set at “2” (Estimated position control) or “3” (Estimated position control + Position adjustment at power ON), the display and setting cannot be performed.
- If you use the motor auto adjust function of the position proportional control, these parameters can be set automatically. Additionally, they can also be set manually in the same manner as described for normal set values.

Note

For details about motor auto adjust,

 ■ Motor auto adjust (on page 5-111).

■ Motor full close–full open time

Item (Bank)	Display	Contents	Initial value	User level
Motor full close–full open time (Setup bank)		5.0 to 240.0s	30.0s	Basic, Standard, High function

- When the control output type is R1 (motor drive relay output), the display and setting can be performed.
- When using the motor auto adjust function of the position proportional control with [C57: Position proportional type] set at “0” (MFB control + Estimated position control) or “1” (MFB control), the motor full close–full open time can be set automatically. Additionally, this time can also be set manually in the same manner as described for normal set values.

Note

For details about motor auto adjust,

 ■ Motor auto adjust (on page 5-111).

- When [C57: Position proportional type] is set at “2” (Estimated position control) or “3” (Estimated position control + Position adjustment at power ON), the actually measured motor full open time is set.

Chapter 6. LIST OF DISPLAYS AND SETTING DATA

6 - 1 List of Operation Displays

The following shows the meanings of the values stated in the “User Level” column:

- 0: Basic, Standard, and High function configuration
- 1: Standard and High function configuration
- 2: High function configuration

■ Operation displays

Display	Item	Contents	Initial value	User level	Notes
Upper display: PV Lower display: SP	SP (Target value)	SP low limit (C07) to SP high limit (C08)	0	0	Whether or not this item is displayed is selected by the PV/SP display setup (C74).
<i>LSP 1</i> (Display example) Lower display: LSP	LSP group number (1st digit: Value at the right end digit)	1 to LSP system group (C30, Max. 8)	1	0	Displayed when LSP system group (C30) is “2” or more. The lower display shows the LSP set value corresponding to the LSP group number. Whether or not this item is displayed is selected by the PV/SP display setup (C74).
<i>St. 1</i> (Display example) Lower display: Step remain time	Step No. and step remain time	Setting is disabled. Upper display shows the step No. (1 to 8), and distinction among the soak, up ramp, and down ramp on the right of “St.”. Lower display shows the soak remain time or ramp remain time.	1	0	Regardless of the soak or ramp operation, the remain time is displayed in step time unit (setup C33). When the unit is 1s, “min.s” is displayed. When the unit is 1min, “h.min” is displayed.
Upper display: PV Lower display: MV	MV (Manipulated Variable)	-10.0 to +110.0% Setting is disabled in AUTO mode. (Numeric value does not flash.) Setting is enabled in MANUAL mode. (Numeric value flashes.)	—	0	In the ON/OFF control (Ctrl = 0), “100.0” is displayed at ON and “0.0” is displayed at OFF. Whether or not this item is displayed is selected by the MV display setup (C75).
<i>HEAT</i>	Heat MV (Manipulated Variable)	Setting is disabled. -10.0 to +110.0%	—	0	This item is displayed when using the Heat/Cool control (C26 = 1). Whether or not this item is displayed is selected by the MV display setup (C75).
<i>Cool</i>	Cool MV (Manipulated Variable)		—	0	
<i>Fb</i>	MFB (Motor opening feedback value)	Setting is disabled. -10.0 to +110.0% Flashing when the value is 0.0 to 100.0% during estimate.	—	0	Displayed when the output type is the position proportional output. Whether or not the MFB is displayed is selected using the MV display setup (C75).
Upper display: PV <i>At 1</i> (Display example)	AT progress display (1st digit = Numeric value at right end digit)	Setting is disabled. Lower display shows the AT progress value on the right of “At”. 1 - : During execution of AT (Value is decreased.) 0: Completion of AT	—	0	Displayed during execution of AT. (The display is continued even after completion of AT.) Whether or not this item is displayed is selected by the MV display setup (C75).
<i>ct 1</i>	CT (Current transformer) current value 1	Setting is disabled.	—	0	Displayed when the optional model has two current transformer points. Whether or not this item is displayed is selected by the CT display setup (C78).
<i>ct 2</i>	CT (Current transformer) current value 2	Setting is disabled.	—	0	
<i>E 1</i>	Internal Event 1 main setting	The allowable setting range may vary depending on the operation type of the internal event. -1999 to +9999U: Set value is other than the following values: 0 to 9999U: Set value is an absolute value. -199.9 to +999.9%: Set value is MV.	0	0	Setting required by the operation type of the internal event is displayed. Whether or not this item is displayed is selected by the EV display setup (C76).
<i>E 1sb</i>	Internal Event 1 sub setting		0	0	

Chapter 6. LIST OF DISPLAYS AND SETTING DATA

Display	Item	Contents	Initial value	User level	Notes
<i>E1</i>	Timer remain time 1	Setting is disabled. Upper display: Displays the distinction between ON delay and OFF delay next to "t1." Lower display: Displays in the unit (any of 0.1s, s, and min), which is determined according to the delay time unit of internal event 1 (3rd digit of E1.C3).	—	0	Whether or not this item is displayed is selected by the timer remain time display setup (C77). "F" is displayed at the right end digit when using the ON delay time. "L" is displayed at the right end digit when using the OFF delay time.
<i>E2</i>	Internal Event 2 main setting	The allowable setting range may vary depending on the operation type of the internal event. -1999 to +9999U: Set value is other than the following values: 0 to 9999U: Set value is an absolute value. -199.9 to +999.9%: Set value is MV.	0	0	Setting required by the operation type of the internal event is displayed. Whether or not this item is displayed is selected by the EV display setup (C76).
<i>E2.5b</i>	Internal Event 2 sub setting		0	0	
<i>E2</i>	Timer remain time 2	Setting is disabled. Upper display: Displays the distinction between ON delay and OFF delay next to "t2." Lower display: Displays in the unit (any of 0.1s, s, and min), which is determined according to the delay time unit of internal event 2 (3rd digit of E2.C3).	—	0	Whether or not this item is displayed is selected by the timer remain time display setup (C77). "F" is displayed at the right end digit when using the ON delay time. "L" is displayed at the right end digit when using the OFF delay time.
<i>E3</i>	Internal Event 3 main setting	The allowable setting range may vary depending on the operation type of the internal event. -1999 to +9999U: Set value is other than the following values. 0 to 9999U: Set value is an absolute value. -199.9 to +999.9%: Set value is MV.	0	0	Setting required by the operation type of the internal event is displayed. Whether or not this item is displayed is selected by the EV display setup (C76).
<i>E3.5b</i>	Internal Event 3 sub setting		0	0	
<i>E3</i>	Timer remain time 3	Setting is disabled. Upper display: Displays the distinction between ON delay and OFF delay next to "t3." Lower display: Displays in the unit (any of 0.1s, s, and min), which is determined according to the delay time unit of internal event 3 (3rd digit of E3.C3).	—	0	Whether or not this item is displayed is selected by the timer remain time display setup (C77). "F" is displayed at the right end digit when using the ON delay time. "L" is displayed at the right end digit when using the OFF delay time.

6 - 2 List of Parameter Setting Displays

The following shows the meanings of the values stated in the “User Level” column:

0: Basic, Standard, and High function configuration

1: Standard and High function configuration

2: High function configuration

The initial value may vary depending on the model No.

■ Mode bank

Bank selection: *mode*

Display	Item	Contents	Initial value	User level	Notes
<i>A--\bar{n}</i>	AUTO/MANUAL	AUto: AUTO mode MAn: MANUAL mode	AUTO	0	Displayed when the control method is other than the ON/OFF control (Ctrl \neq 0). Whether or not this item is displayed is selected by the display mode setup (C73).
<i>r---r</i>	RUN/READY	rUn: RUN mode rdy: READY mode	RUN	0	Whether or not this item is displayed is selected by the display mode setup (C73).
<i>L---r</i>	LSP/RSP	LSP: LSP mode rSP: RSP mode	LSP	0	When the model provides the RSP input, the display is possible. Whether or not this item is displayed is selected by the display mode setup (C73).
<i>At</i>	AT stop/start	At.oF: AT stop At.on: AT start	AT stop	0	Displayed when the control method is other than the ON/OFF control (Ctrl \neq 0). Whether or not this item is displayed is selected by the display mode setup (C73).
<i>doLl</i>	Release all DO latches	Lt.on: Latch continue Lt.oF: Latch release	Latch continue	0	All DO latches such as control outputs (relay and voltage pulse) and event outputs can be released. Whether or not this item is displayed is selected by the display mode setup (C73).
<i>[d] i</i>	Communication DI	dl.oF: OFF dl.on: ON	OFF	0	Whether or not this item is displayed is selected by the display mode setup (C73).

■ SP bank

Bank selection: *SP*

Display	Item	Contents	Initial value	User level	Notes
<i>rSP</i>	RSP	Setting is disabled.	—	0	Displayed when the optional model provides the RSP input.
<i>PI dr</i>	PID group No. (For RSP)	1 to 8	1	1	Displayed when the optional model provides the RSP input, the control is other than ON/OFF control (Ctrl≠0), and the zone PID is not used (C24=0).
<i>SP-1</i>	SP of LSP 1 group	SP low limit (C07) to SP high limit (C08)	0	0	
<i>PI dl</i>	PID group No. (For LSP1)	1 to 8	1	1	Displayed when the control is other than ON/OFF control (Ctrl≠0) and the zone PID is not used (C24=0).
<i>rñP.1</i>	Ramp (For LSP1)	0 to 9999 (The decimal point position is determined by the decimal point position of PV and the SP ramp unit.)	0	1	Displayed when the SP ramp type (C31) is "1" or more.
<i>tñ.1</i>	Time (For LSP1)	0.0 to 999.9 (The time unit of the step operation is "0.1s") 0 to 9999 (The time unit of the step operation is "1s" or "1min".)	0	1	Displayed when the SP ramp type (C31) is "2" or more.
<i>SP-2</i>	SP of LSP 2 group	Same as LSP1 group.	0	0	Displayed when the LSP system group (C30) is "2" or more and the same conditions as those for the LSP1 group are satisfied.
<i>PI d2</i>	PID group No. (For LSP2)		1	1	
<i>rñP.2</i>	Ramp (For LSP2)		0	1	
<i>tñ.2</i>	Time (For LSP2)		0	1	
<i>SP-3</i>	SP of LSP 3 group	Same as LSP1 group.	0	0	Displayed when the LSP system group (C30) is "3" or more and the same conditions as those for the LSP1 group are satisfied.
<i>PI d3</i>	PID group No. (For LSP3)		1	1	
<i>rñP.3</i>	Ramp (For LSP3)		0	1	
<i>tñ.3</i>	Time (For LSP3)		0	1	
<i>SP-4</i>	SP of LSP 4 group	Same as LSP1 group.	0	0	Displayed when the LSP system group (C30) is "4" or more and the same conditions as those for the LSP1 group are satisfied.
<i>PI d4</i>	PID group No. (For LSP4)		1	1	
<i>rñP.4</i>	Ramp (For LSP4)		0	1	
<i>tñ.4</i>	Time (For LSP4)		0	1	
<i>SP-5</i>	SP of LSP 5 group	Same as LSP1 group.	0	0	Displayed when the LSP system group (C30) is "5" or more and the same conditions as those for the LSP1 group are satisfied.
<i>PI d5</i>	PID group No. (For LSP5)		1	1	
<i>rñP.5</i>	Ramp (For LSP5)		0	1	
<i>tñ.5</i>	Time (For LSP5)		0	1	
<i>SP-6</i>	SP of LSP 6 group	Same as LSP1 group.	0	0	Displayed when the LSP system group (C30) is "6" or more and the same conditions as those for the LSP1 group are satisfied.
<i>PI d6</i>	PID group No. (For LSP6)		1	1	
<i>rñP.6</i>	Ramp (For LSP6)		0	1	
<i>tñ.6</i>	Time (For LSP6)		0	1	
<i>SP-7</i>	SP of LSP 7 group	Same as LSP1 group.	0	0	Displayed when the LSP system group (C30) is "7" or more and the same conditions as those for the LSP1 group are satisfied.
<i>PI d7</i>	PID group No. (For LSP7)		1	1	
<i>rñP.7</i>	Ramp (For LSP7)		0	1	
<i>tñ.7</i>	Time (For LSP7)		0	1	
<i>SP-8</i>	SP of LSP 8 group	Same as LSP1 group.	0	0	Displayed when the LSP system group (C30) is "8" or more and the same conditions as those for the LSP1 group are satisfied.
<i>PI d8</i>	PID group No. (For LSP8)		1	1	
<i>rñP.8</i>	Ramp (For LSP8)		0	1	
<i>tñ.8</i>	Time (For LSP8)		0	1	

■ Event bank

Bank selection: *Eu*

Display	Item	Contents	Initial value	User level	Notes
<i>E 1</i>	Internal Event 1 main setting	-1999 to +9999 The decimal point position may vary so that it meets the operation type of the internal event.	0	0	Necessary settings are displayed according to Internal Event 1 operation type (E1.C1).
<i>E 1Sb</i>	Internal Event 1 sub-setting		The above value becomes 0 to 9999 in some operation types.	0	
<i>E 1HY</i>	Internal Event 1 Hysteresis	0 to 9999 The decimal point position may vary so that it meets the operation type of the internal event.	5	0	
<i>E 1on</i>	Internal Event 1 ON delay time	0.0 to 999.9 (Delay unit is 0.1s.) 0 to 9999 (Delay unit is other than 0.1s.)	0	2	
<i>E 1oF</i>	Internal Event 1 OFF delay time		0	2	
<i>E 2</i>	Internal Event 2 main setting	Same as Internal Event 1.	0	0	Necessary settings are displayed according to Internal Event 2 operation type (E2.C1).
<i>E 2Sb</i>	Internal Event 2 sub-setting		0	0	
<i>E 2HY</i>	Internal Event 2 Hysteresis		5	0	
<i>E 2on</i>	Internal Event 2 ON delay time		0	2	
<i>E 2oF</i>	Internal Event 2 OFF delay time		0	2	
<i>E 3</i>	Internal Event 3 main setting	Same as Internal Event 1.	0	0	Necessary settings are displayed according to Internal Event 3 operation type (E3.C1).
<i>E 3Sb</i>	Internal Event 3 sub-setting		0	0	
<i>E 3HY</i>	Internal Event 3 Hysteresis		5	0	
<i>E 3on</i>	Internal Event 3 ON delay time		0	2	
<i>E 3oF</i>	Internal Event 3 OFF delay time		0	2	
<i>E 4</i>	Internal Event 4 main setting	Same as Internal Event 1.	0	0	Necessary settings are displayed according to Internal Event 4 operation type (E4.C1).
<i>E 4Sb</i>	Internal Event 4 sub-setting		0	0	
<i>E 4HY</i>	Internal Event 4 Hysteresis		5	0	
<i>E 4on</i>	Internal Event 4 ON delay time		0	2	
<i>E 4oF</i>	Internal Event 4 OFF delay time		0	2	
<i>E 5</i>	Internal Event 5 main setting	Same as Internal Event 1.	0	0	Necessary settings are displayed according to Internal Event 5 operation type (E5.C1).
<i>E 5Sb</i>	Internal Event 5 sub-setting		0	0	
<i>E 5HY</i>	Internal Event 5 Hysteresis		5	0	
<i>E 5on</i>	Internal Event 5 ON delay time		0	2	
<i>E 5oF</i>	Internal Event 5 OFF delay time		0	2	

(Continue on next page.)

Chapter 6. LIST OF DISPLAYS AND SETTING DATA

Display	Item	Contents	Initial value	User level	Notes
<i>E6</i>	Internal Event 6 main setting	Same as Internal Event 1.	0	0	Necessary settings are displayed according to Internal Event 6 operation type (E6.C1).
<i>E6.5b</i>	Internal Event 6 sub-setting		0	0	
<i>E6.HY</i>	Internal Event 6 Hysteresis		5	0	
<i>E6.on</i>	Internal Event 6 ON delay time		0	2	
<i>E6.oF</i>	Internal Event 6 OFF delay time		0	2	
<i>E7</i>	Internal Event 7 main setting	Same as Internal Event 1.	0	0	Necessary settings are displayed according to Internal Event 7 operation type (E7.C1).
<i>E7.5b</i>	Internal Event 7 sub-setting		0	0	
<i>E7.HY</i>	Internal Event 7 Hysteresis		5	0	
<i>E7.on</i>	Internal Event 7 ON delay time		0	2	
<i>E7.oF</i>	Internal Event 7 OFF delay time		0	2	
<i>E8</i>	Internal Event 8 main setting	Same as Internal Event 1.	0	0	Necessary settings are displayed according to Internal Event 8 operation type (E8.C1).
<i>E8.5b</i>	Internal Event 8 sub-setting		0	0	
<i>E8.HY</i>	Internal Event 8 Hysteresis		5	0	
<i>E8.on</i>	Internal Event 8 ON delay time		0	2	
<i>E8.oF</i>	Internal Event 8 OFF delay time		0	2	

■ PID bank

Bank selection: *P I d*

Display	Item	Contents	Initial value	User level	Notes
<i>P-1</i>	Proportional band (PID 1)	0.1 to 999.9%	5.0	0	Displayed when the control method is other than the ON/OFF control (Ctrl≠0).
<i>I-1</i>	Integral time (PID 1)	0 to 9999s or 0.0 to 999.9s (Note) (No integration control action when set at "0".)	120	0	
<i>d-1</i>	Derivative time (PID 1)	0 to 9999s or 0.0 to 999.9s (Note) (No derivative control action when set at "0".)	30	0	
<i>rE-1</i>	Manual reset (PID 1)	-10.0 to +110.0%	50.0	0	Displayed when the control method is other than the ON/OFF control (Ctrl≠0) and the I (Integral time) in the same PID group is "0".
<i>oL-1</i>	MV low limit (PID 1)	-10.0 to +110.0%	0.0	1	Displayed when the control method is other than the ON/OFF control (Ctrl≠0) or Displayed when the control method is other than the ON/OFF control (Ctrl≠0) and the Heat/Cool control is used (C26 = 1).
<i>oH-1</i>	MV high limit (PID 1)	-10.0 to +110.0%	100.0	1	
<i>P-1C</i>	Proportional band for cool side (PID 1)	0.1 to 999.9%	5.0	0	
<i>I-1C</i>	Integral time for cool side (PID 1)	0 to 9999s or 0.0 to 999.9s (Note) (No integration control action when set at "0".)	120	0	
<i>d-1C</i>	Derivative time for cool side (PID 1)	0 to 9999s or 0.0 to 999.9s (Note) (No derivative control action when set at "0".)	30	0	
<i>oL.1C</i>	Output low limit for cool side (PID 1)	-10.0 to +110.0%	0.0	1	
<i>oH.1C</i>	Output high limit for cool side (PID 1)	-10.0 to +110.0%	100.0	1	
<i>P-2</i>	Proportional band (PID 2)	Same as PID 1	5.0	0	
<i>I-2</i>	Integral time (PID 2)		120	0	
<i>d-2</i>	Derivative time (PID 2)		30	0	
<i>rE-2</i>	Manual reset (PID 2)		50.0	0	
<i>oL-2</i>	MV low limit (PID 2)		0.0	1	
<i>oH-2</i>	MV high limit (PID 2)		100.0	1	
<i>P-2C</i>	Proportional band for cool side (PID 2)		5.0	0	
<i>I-2C</i>	Integral time for cool side (PID 2)		120	0	
<i>d-2C</i>	Derivative time for cool side (PID 2)		30	0	
<i>oL.2C</i>	Output low limit for cool side (PID 2)		0.0	1	
<i>oH.2C</i>	Output high limit for cool side (PID 2)		100.0	1	

(Note) For presence of the decimal point, when [C23: PID Decimal point position] is set at "0", the decimal point does not exist. When this setting is set at "1", the decimal point exists.

(Continue on next page.)

Chapter 6. LIST OF DISPLAYS AND SETTING DATA

Display	Item	Contents	Initial value	User level	Notes
<i>P-3</i>	Proportional band (PID 3)	Same as PID 1	5.0	0	Same as PID 1
<i>I-3</i>	Integral time (PID 3)		120	0	
<i>d-3</i>	Derivative time (PID 3)		30	0	
<i>rE-3</i>	Manual reset (PID 3)		50.0	0	
<i>oL-3</i>	MV low limit (PID 3)		0.0	1	
<i>oH-3</i>	MV high limit (PID 3)		100.0	1	
<i>P-3C</i>	Proportional band for cool side (PID 3)		5.0	0	
<i>I-3C</i>	Integral time for cool side (PID 3)		120	0	
<i>d-3C</i>	Derivative time for cool side (PID 3)		30	0	
<i>oL3C</i>	Output low limit for cool side (PID 3)		0.0	1	
<i>oH3C</i>	Output high limit for cool side (PID 3)		100.0	1	
<i>P-4</i>	Proportional band (PID 4)		Same as PID 1	5.0	
<i>I-4</i>	Integral time (PID 4)	120		0	
<i>d-4</i>	Derivative time (PID 4)	30		0	
<i>rE-4</i>	Manual reset (PID 4)	50.0		0	
<i>oL-4</i>	MV low limit (PID 4)	0.0		1	
<i>oH-4</i>	MV high limit (PID 4)	100.0		1	
<i>P-4C</i>	Proportional band for cool side (PID 4)	5.0		0	
<i>I-4C</i>	Integral time for cool side (PID 4)	120		0	
<i>d-4C</i>	Derivative time for cool side (PID 4)	30		0	
<i>oL4C</i>	Output low limit for cool side (PID 4)	0.0		1	
<i>oH4C</i>	Output high limit for cool side (PID 4)	100.0		1	
<i>P-5</i>	Proportional band (PID 5)	Same as PID 1		5.0	0
<i>I-5</i>	Integral time (PID 5)		120	0	
<i>d-5</i>	Derivative time (PID 5)		30	0	
<i>rE-5</i>	Manual reset (PID 5)		50.0	0	
<i>oL-5</i>	MV low limit (PID 5)		0.0	1	
<i>oH-5</i>	MV high limit (PID 5)		100.0	1	
<i>P-5C</i>	Proportional band for cool side (PID 5)		5.0	0	
<i>I-5C</i>	Integral time for cool side (PID 5)		120	0	
<i>d-5C</i>	Derivative time for cool side (PID 5)		30	0	
<i>oL5C</i>	Output low limit for cool side (PID 5)		0.0	1	
<i>oH5C</i>	Output high limit for cool side (PID 5)		100.0	1	

(Continue on next page.)

Display	Item	Contents	Initial value	User level	Notes
<i>P-6</i>	Proportional band (PID 6)	Same as PID 1	5.0	0	Same as PID 1
<i>I-6</i>	Integral time (PID 6)		120	0	
<i>d-6</i>	Derivative time (PID 6)		30	0	
<i>rE-6</i>	Manual reset (PID 6)		50.0	0	
<i>oL-6</i>	MV low limit (PID 6)		0.0	1	
<i>oH-6</i>	MV high limit (PID 6)		100.0	1	
<i>P-6C</i>	Proportional band for cool side (PID 6)		5.0	0	
<i>I-6C</i>	Integral time for cool side (PID 6)		120	0	
<i>d-6C</i>	Derivative time for cool side (PID 6)		30	0	
<i>oL6C</i>	Output low limit for cool side (PID 6)		0.0	1	
<i>oH6C</i>	Output high limit for cool side (PID 6)		100.0	1	
<i>P-7</i>	Proportional band (PID 7)		Same as PID 1	5.0	
<i>I-7</i>	Integral time (PID 7)	120		0	
<i>d-7</i>	Derivative time (PID 7)	30		0	
<i>rE-7</i>	Manual reset (PID 7)	50.0		0	
<i>oL-7</i>	MV low limit (PID 7)	0.0		1	
<i>oH-7</i>	MV high limit (PID 7)	100.0		1	
<i>P-7C</i>	Proportional band for cool side (PID 7)	5.0		0	
<i>I-7C</i>	Integral time for cool side (PID 7)	120		0	
<i>d-7C</i>	Derivative time for cool side (PID 7)	30		0	
<i>oL.7C</i>	Output low limit for cool side (PID 7)	0.0		1	
<i>oH.7C</i>	Output high limit for cool side (PID 7)	100.0		1	
<i>P-8</i>	Proportional band (PID 8)	Same as PID 1		5.0	0
<i>I-8</i>	Integral time (PID 8)		120	0	
<i>d-8</i>	Derivative time (PID 8)		30	0	
<i>rE-8</i>	Manual reset (PID 8)		50.0	0	
<i>oL-8</i>	MV low limit (PID 8)		0.0	1	
<i>oH-8</i>	MV high limit (PID 8)		100.0	1	
<i>P-8C</i>	Proportional band for cool side (PID 8)		5.0	0	
<i>I-8C</i>	Integral time for cool side (PID 8)		120	0	
<i>d-8C</i>	Derivative time for cool side (PID 8)		30	0	
<i>oL.8C</i>	Output low limit for cool side (PID 8)		0.0	1	
<i>oH.8C</i>	Output high limit for cool side (PID 8)		100.0	1	

■ Parameter bank

Bank selection: *PARA*

Display	Item	Contents	Initial value	User level	Notes
<i>Ctrl</i>	Control method	0: ON/OFF control 1: Fixed PID	0 or 1	0	The initial value is "0" when the control output uses only one point and is the relay output. The initial value is "1" in other cases.
<i>Atol</i>	MV low limit at AT	-10.0 to +110.0%	0.0	0	Displayed when the control method is other than the ON/OFF control (Ctrl≠0).
<i>Atoh</i>	MV high limit at AT	-10.0 to +110.0%	100.0	0	
<i>dIFF</i>	Differential (for ON/OFF control)	0 to 9999U	5	0	Displayed when the control method is the ON/OFF control (Ctrl=0).
<i>OFF5</i>	ON/OFF control action point offset	-1999 to +9999U	0	2	
<i>FL</i>	PV filter	0 to 120.0s	0.0	0	
<i>rR</i>	PV ratio	0.001 to 9.999	1.000	1	
<i>b1</i>	PV bias	-1999 to +9999U	0	0	
<i>FL2</i>	RSP filter	0.0 to 120.0s	0.0	1	Displayed when the model provides the RSP input.
<i>rR2</i>	RSP ratio	0.001 to 9.999	1.000	1	
<i>b12</i>	RSP bias	-1999 to +9999U	0	1	
<i>CYU</i>	Time proportional cycle unit 1 (for MV1)	0: 1s unit 1: Cycle fixed at 0.5s. 2: Cycle fixed at 0.25s. 3: Cycle fixed at 0.1s If the set value is other than "0", the time proportional cycle 1 (Cy) cannot be set.	0	2	Displayed under the same conditions as <i>CY</i> except that a relay is not included in the output.
<i>CY</i>	Time proportional cycle 1 (for MV1)	5 to 120s (Output destination of MV1 includes the relay output.) 1 to 120s (Output destination of MV1 does not include the relay output.) If the time proportional unit 1 (CyU) ≠ 0, this setting becomes invalid and the setting becomes impossible.	10 or 2	0	Displayed when MV1 (time proportional output (heat) of Heat/Cool control) is connected to the relay control output, voltage pulse output, or event output in the DO Assignment. The initial value of time proportional cycle 1 is "10" when the control output is the relay output. The initial value is "2" in other cases.
<i>CYU2</i>	Time proportional cycle unit 2 (for MV2)	0: 1s unit 1: Cycle fixed at 0.5s. 2: Cycle fixed at 0.25s. 3: Cycle fixed at 0.1s If the set value is other than "0", the time proportional cycle 2 (Cy2) cannot be set.	0	2	Displayed under the same conditions as <i>CY2</i> except that a relay is not included in the output.
<i>CY2</i>	Time proportional cycle 2 (for MV2)	5 to 120s (Output destination of MV2 includes the relay output.) 1 to 120s (Output destination of MV2 does not include the relay output.) If the time proportional unit 2 (CyU2) ≠ 0, this setting becomes invalid and the setting becomes impossible.	10 or 2	0	Displayed when the Heat/Cool control is used (C26=1) and MV2 (time proportional output (cool) of Heat/Cool control) is connected to the relay control output, voltage pulse control output, or event output. The initial value of time proportional cycle 2 is "10" when the model has one control output point. The initial value is "2" in other cases.

Display	Item	Contents	Initial value	User level	Notes
<i>tP.tY</i>	Time proportional cycle mode	0: Controllability aiming type 1: Actuator service life aiming type (Only one ON/OFF operation within time proportional cycle)	0 or 1	2	The initial value is "1" when control output 1 is the relay output. The initial value is "0" in other cases.
<i>oU.tL</i>	Output variation limit	0.0: No limit. 0.1 to 999.9%/s	0.0	2	Not displayed when the model provides the motor drive relay output and [aiming at service life of potentiometer] is set (C59=1).
<i>SP.U</i>	SP ramp-up	0.0 to 999.9U (No ramp when set at "0.0U")	0.0	2	Time unit of the ramp is selected by the SP ramp unit (C32). Displayed when the SP ramp type is set at "standard" (C31=0).
<i>SP.d</i>	SP ramp-down		0.0	2	

■ **Extended tuning bank**

Bank selection: *Et*

Display	Item	Contents	Initial value	User level	Notes
<i>At.tY</i>	AT type	0: Normal (Standard control characteristics) 1: Immediate response (Control characteristics that respond immediately to external disturbance.) 2: Stable (Control characteristics having less up/down fluctuation of PV)	0	0	Displayed when the control method is other than the ON/OFF control (Ctrl≠0). The initial value of "At-d" is "0.00" when the control output type is R1. The initial value of "At-d" is "1.00" when the control output type is other than R1.
<i>JF.bd</i>	Just-FiTTER settling band	0.00 to 10.00	0.30	2	
<i>SP.Lg</i>	SP lag constant	0.0 to 999.9	0.0	2	
<i>At-P</i>	AT Proportional band adjust	0.00 to 99.99	1.00	2	
<i>At-I</i>	AT Integral time adjust	0.00 to 99.99	1.00	2	
<i>At-d</i>	AT Derivative time adjust	0.00 to 99.99	1.00 or 0.00	2	
<i>Ctrl.A</i>	Control algorithm	0: PID (Conventional PID) 1: RationalLOOP (High-performance PID)	0	1	
<i>JF.ov</i>	Just-FiTTER overshoot limit/restraint/control coefficient	0 to 100	0	1	

■ **Zone bank**

Bank selection: *Zone*

Display	Item	Contents	Initial value	User level	Notes
<i>zn-1</i>	Zone 1	-1999 to +9999U	9999U	2	Displayed when the zone PID operation is used (C24≠0).
<i>zn-2</i>	Zone 2		9999U	2	
<i>zn-3</i>	Zone 3		9999U	2	
<i>zn-4</i>	Zone 4		9999U	2	
<i>zn-5</i>	Zone 5		9999U	2	
<i>zn-6</i>	Zone 6		9999U	2	
<i>zn-7</i>	Zone 7		9999U	2	
<i>zn.dF</i>	Zone hysteresis	0 to 9999	5U	2	

6 - 3 List of Setup Setting Displays

The following shows the meanings of the values stated in the “User Level” column:

- 0: Basic, Standard, and High function configuration
- 1: Standard and High function configuration
- 2: High function configuration

Initial value may differ depending on model No.

■ Setup bank

Bank selection: *SETUP*

Display	Item	Contents	Initial value	User level	Notes
<i>C 01</i>	PV input range type	Range of thermocouple: 1 to 26 Range of RTD: 41 to 68 Range of DC voltage and DC current: 81 to 84, 86 to 90	88	0	For details, refer to the PV Input Range Table (on page 5-2).
<i>C 02</i>	Temperature unit	0: Celsius (°C) 1: Fahrenheit (°F)	0	0	Displayed when the PV input range type is thermocouple or RTD.
<i>C 03</i>	Cold junction compensation (T/C)	0: Cold junction compensation (T/C) is performed (internal). 1: Cold junction compensation (T/C) is not performed (external).	0	2	Displayed when the PV input range type is thermocouple.
<i>C 04</i>	Decimal point position	0: No decimal point 1: 1 digit after decimal point 2: 2 digits after decimal point 3: 3 digits after decimal point (Range with decimal point of thermocouple/RTD: 0 to 1)	0	0	Displayed when the PV input type is DC voltage/DC current or thermocouple/RTD having the range with the decimal point.
<i>C 05</i>	PV input range low limit	When the PV input range type is thermocouple or RTD, the input range low limit selected with the PV input range type (C01) is displayed, but the setting is disabled. When the PV input range type is DC voltage/DC current, a value ranging from -1999 to +9999 is set.	0	0	
<i>C 06</i>	PV input range high limit	When the PV input range type is thermocouple or RTD, the input range high limit selected with the PV input range type (C01) is displayed, but the setting is disabled. When the PV input type is DC voltage/DC current, a value ranging from -1999 to +9999 is set.	1000	0	
<i>C 07</i>	SP low limit	PV input range low limit to PV input range high limit	0	1	
<i>C 08</i>	SP high limit		1000	1	
<i>C 09</i>	PV square root extraction dropout	0.0 to 100.0 (PV square root extraction is not performed when set at “0.0”.)	0.0	2	Displayed when the PV input range type is DC voltage/DC current.
<i>C 10</i>	RSP input type	0: 4 to 20mA 1: 0 to 20mA 2: 0 to 5V 3: 1 to 5V 4: 0 to 10V	0	0	Displayed when the model provides the RSP input.
<i>C 11</i>	RSP input range low limit	-1999 to +9999U	0	0	
<i>C 12</i>	RSP input range high limit	-1999 to +9999U	1000	0	
<i>C 13</i>	PID calculation adjustment function	0: Enabled 1: Disabled	0	2	Normally, the PV filter is used with an initial value. If ROM version 1 in the instrument information bank (<i>1 002</i>) is 2.26 or earlier, this item cannot be displayed.
<i>C 14</i>	Control action (Direct/Reverse)	0: Reverse action (Heat) 1: Direct action (Cool)	0	0	Displayed when the heat/cool control is not used (C26=0).

(Continue on next page.)

Display	Item	Contents	Initial value	User level	Notes
C 15	Output operation at PV alarm	0: Control calculation is continued. 1: Output at PV alarm is output.	0	2	
C 16	Output at PV alarm	-10.0 to +110.0%	0.0	2	
C 17	Output at READY (Heat)	-10.0 to +110.0%	0.0	1	
C 18	Output at READY (Cool)	-10.0 to +110.0%	0.0	1	Displayed when the control method is other than the ON/OFF control (Ctrl≠0) and the heat/cool control (C26 = 1) is used.
C 19	Output operation at changing Auto/Manual	0: Bumpless transfer 1: Preset	0	1	Displayed when the control method is other than the ON/OFF control (Ctrl≠0). When the operation mode is the MANUAL mode at power ON, the preset MANUAL value (C20) becomes the Manipulated Variable (MV).
C 20	Preset MANUAL value	-10.0 to +110.0% (Used when the operation mode is the MANUAL mode at power ON.)	0.0 or 50.0	1	
C 21	Initial output type (mode) of PID control	0: Auto 1: Not initialized. 2: Initialized (If SP value different from the current value is input.)	0	2	
C 22	Initial output of PID control	-10.0 to +110.0%	0.0 or 50.0	2	
C 23	PID Decimal point position	0: No decimal point 1: 1 digit after decimal point (Decimal point of integral time and derivative time)	0	2	Displayed when the control method is other than the ON/OFF control (Ctrl≠0).
C 24	Zone PID operation	0: Disabled. 1: Changed by SP. 2: Changed by PV.	0	2	
C 26	Heat/Cool control	0: Not used. 1: Used.	0	0	Displayed when the control output type is other than R1 (motor drive relay output), and when the control method is other than the ON/OFF control (Ctrl≠0). When set at "1", the control action is set to the reverse action (C14 = 0), the preset MANUAL value (C20) is set to "50.0", and the initial output of the PID control (C22) is changed to "50.0".
C 27	Heat/Cool selection	0: Normal 1: Energy saving	0	1	Displayed when the Heat/Cool control is used (C26 = 1).
C 28	Heat/Cool control deadband	-100.0 to +100.0%	0.0	0	
C 29	Heat/Cool control change point	-10.0 to +110.0%	50.0	2	
C 30	LSP system group	1 to 8	1	0	
C 31	SP ramp type	0: Standard 1: Multi-ramp 2: Step operation When the power is turned ON again, the step operation is stopped (READY). 3: Step operation When the power is turned ON again, the step operation is reset.	0	2	
C 32	SP ramp unit	0: 0.1U/s 1: 0.1U/min 2: 0.1U/h	1	2	"0.1U" shows that the decimal point position of the PV is shifted one digit rightward.
C 33	STEP time unit	0: 0.1s 1: 1s ("min. s" is displayed on the console.) 2: 1min ("h. min" is displayed on the console.)	0	2	Displayed when the SP ramp type is the step operation (C31≥2).

(Continue on next page.)

Chapter 6. LIST OF DISPLAYS AND SETTING DATA

Display	Item	Contents	Initial value	User level	Notes
[34	STEP PV start	0: None 1: Up start 2: Down start	0	2	Displayed when the SP ramp type is the step operation (C31≥2).
[35	STEP loop	0: Stop (No loop) 1: Loop 2: Final step continued. (No loop)	0	2	
[36	CT1 operation type	0: Heater burnout detection 1: Current value measurement	0	0	Displayed when the optional model has two current transformer input points.
[37	CT1 output	0: Control output 1 1: Control output 2 2: Event output 1 3: Event output 2 4: Event output 3	0	0	Displayed when the optional model has two current transformer input points and the CT1 operation type is set to "heater burnout detection" (C36 = 0).
[38	CT1 measurement wait time	30 to 300ms	30	0	
[39	CT2 operation type	Same as CT1 operation type	0	0	Displayed when the optional model has two current transformer input points.
[40	CT2 output	Same as CT1 output	0	0	Displayed when the optional model has two current transformer input points and the CT2 operation type is set to "heater burnout detection" (C39 = 0).
[41	CT2 measurement wait time	Same as CT1 measurement wait time	30	0	
[42	Control output 1 range	Current output 1: 4 to 20mA 2: 0 to 20mA Continuous voltage output 1: 1 to 5V 2: 0 to 5V 3: 0 to 10V	1	0	Displayed when control output 1 of the model is the current output or continuous voltage output. The decimal point position of the scaling low limit/high limit becomes 1 digit after the decimal point when the control output 1 type is related to the MV and CT. When the control output 1 type is related to the PV and SP, the decimal point position becomes the same as that of the PV. The unit of scaling low limit/high limit depends on the output type of control output 1. When the output type relative to MV and MFB; %.
[43	Control output 1 type	0: MV 1: Heat MV (for heat/cool control) 2: Cool MV (for heat/cool control) 3: PV 4: PV before ratio, bias, and filter 5: SP 6: Deviation 7: CT1 current value 8: CT2 current value 9: MFB (including estimated MFB) 10: SP+MV 11: PV+MV	0	0	
[44	Control output 1 scaling low limit	-1999 to +9999 The decimal point position and unit may vary depending on control output 1 type.	0	0	When the output type relative to PV and SP; same as PV. When the output type relative to CT; ampere (current value).
[45	Control output 1 scaling high limit		100.0	0	
[46	Control output 1 MV scaling range	0 to 9999 The decimal point position and unit are same as for PV.	200.0	0	If the controller model uses current output for control output 1 and if the control output 1 type is SP+MV or PV+MV, this setting is displayed.
[47	Control output 2 range	Same as control output 1.	1	0	Displayed when control output 2 of the model is the current output or continuous voltage output.
[48	Control output 2 type		3	0	
[49	Control output 2 scaling low limit	-1999 to +9999 The decimal point position and unit may vary depending on control output 2 type.	0	0	The decimal point position and unit is same as that of control output 1.
[50	Control output 2 scaling high limit		1000	0	
[51	Control output 2 MV scaling range	0 to 9999 The decimal point position and unit are same as for PV.	200.0	0	If the controller model uses current output for control output 2 and if the control output 2 type is SP+MV or PV+MV, this setting is displayed.

Display	Item	Contents	Initial value	User level	Notes
[52	AUX range type	Same as control output 1. -1999 to +9999 (The decimal point position and unit may vary depending on the AUX type.)	1	0	Displayed when the auxiliary output of the model is the current output or continuous voltage output. The decimal point position and unit is the same as that of the control output 1.
[53	AUX type		3	0	
[54	AUX Value at 0% output		0	0	
[55	AUX Value at 100% output		1000	0	
[56	Auxiliary output MV scaling range	0 to 9999 The decimal point position and unit are same as for PV.	200.0	0	If the controller model uses current output for the auxiliary output and if the auxiliary output type is SP+MV or PV+MV, this setting is displayed.
[57	Position proportional type	0: MFB control + Estimated position control 1: MFB control 2: Estimated position control (MFB disabled) 3: Estimated position control (MFB disabled) + Position adjustment at power ON.	0	0	Displayed when the model provides the position proportional output.
[58	Position proportional deadband	0.5 to 25.0%	10.0	0	
[59	Motor long life mode	0: Aiming at controllability 1: Aiming at service life of potentiometer	1	0	
[60	Motor auto adjust	0: Stop 1: Start	0	0	Displayed when the model provides the position proportional output. The motor adjust is stopped using the [disp] or [mode] key through the control operation. It is impossible to write data through the loader.
[61	Input with motor fully closed	0 to 9999	1000	0	Displayed when the model provides the position proportional output. It is impossible to write data through the loader.
[62	Input with motor fully open	0 to 9999	3000	0	
[63	Motor full close-full open time	5.0 to 240.0s	30.0	0	
[64	CPL/Modbus	0: CPL 1: Modbus (ASCII format) 2: Modbus (RTU format)	0	0	Displayed when the optional model has RS-485.
[65	Station address	0 to 127 (Communication is disabled when set at "0".)	0	0	
[66	Transmission speed	0: 4800bps 1: 9600bps 2: 19200bps 3: 38400bps	2	0	
[67	Data format (Data length)	0: 7 bits 1: 8 bits	1	0	
[68	Data format (Parity)	0: Even parity 1: Odd parity 2: No parity	0	0	

(Continue on next page.)

! Handling Precautions

- If ROM version 1 of the instrument information bank(*id02*) is prior to 2.04, SP+MV and PV+MV cannot be set in [Control output 1 type], [Control output 2 type], and [Auxiliary output type].
- If ROM version 1 of the instrument information bank(*id02*) is prior to 2.04, SP+MV and PV+MV cannot be set in [Control output 1 MV scaling range], [Control output 2 MV scaling range], and [Auxiliary output MV scaling range].

Chapter 6. LIST OF DISPLAYS AND SETTING DATA

Display	Item	Contents	Initial value	User level	Notes
[69	Data format (Stop bit)	0: 1 bit 1: 2 bits	0	0	Displayed when the optional model has RS-485.
[70	Response time-out	1 to 250ms	3	2	
[71	Key operation type	0: Standard type 1: Special type	0	2	
[72	[mode] key function	0: Invalid 1: AUTO/MANUAL selection 2: RUN/READY selection 3: AT Stop/Start 4: LSP group selection 5: Release all DO latches 6: LSP/RSP selection 7: Communication DI1 selection 8: Invalid	1	0	
[73	MODE display setup	Whether or not the mode bank setup is displayed is determined by the sum of the following weights: Bit 0: AUTO/MANUAL display Disabled: 0, Enabled: +1 Bit 1: RUN/READY display Disabled: 0, Enabled: +2 Bit 2: LSP/RSP display Disabled: 0, Enabled: +4 Bit 3: AT stop/start display Disabled: 0, Enabled: +8 Bit 4: Release all DO latches display Disabled: 0, Enabled: +16 Bit 5: Communication DI1 ON/OFF display Disabled: 0, Enabled: +32 Other invalid settings, 0, +64, +128	255	1	
[74	PV/SP display setup	Whether or not the PV/SP value related items are displayed in the basic display mode is determined by the sum of the following weights: Bit 0: PV display Disabled: 0, Enabled: +1 Bit 1: SP display Disabled: 0, Enabled: +2 Bit 2: LSP group number display Disabled: 0, Enabled: +4 Other invalid settings, 0, +8	15	1	
[75	MV display setup	Whether or not the PV/SP value related items are displayed in the basic display mode is determined by the sum of the following weights: Bit 0: MV display Disabled: 0, Enabled: +1 Bit 1: Heat MV/cool MV display Disabled: 0, Enabled: +2 Bit 2: MFB display Disabled: 0, Enabled: +4 Bit 3: AT progress display Disabled: 0, Enabled: +8	15	1	
[76	EV display setup	0: Internal Event set value is not displayed in the operation display mode. 1: Set value of Internal Event 1 is displayed in the operation display mode. 2: Set values of Internal Events 1 to 2 are displayed in the operation display mode. 3: Set values of Internal Events 1 to 3 are displayed in the operation display mode.	0	1	

(Continue on next page.)

Display	Item	Contents	Initial value	User level	Notes
[77	Timer remaining time display setup	0: ON/OFF delay remaining time of Internal Event is not displayed in the operation display mode. 1: ON/OFF delay remaining time of Internal Event 1 is displayed in the operation display mode. 2: ON/OFF delay remaining time of Internal Events 1 to 2 are displayed in the operation display mode. 3: ON/OFF delay remaining time of Internal Events 1 to 3 are displayed in the operation display mode.	0	1	
[78	CT display setup	0: CT current value is not displayed in the operation display mode. 1: CT1 current value is displayed in the operation display mode. 2: CT1 to 2 current values are displayed in the operation display mode.	0	1	
[79	User level	0: Basic configuration 1: Standard configuration 2: High function configuration	0	1	
[80	Communication monitoring display	0: Not used. 1: Flashing while data is being sent through RS-485 communication. 2: Flashing while data is being received through RS-485 communication. 3: Logical OR of all DI statuses 4: Flashing in READY mode	0	2	
[81	Multi Status (MS) display, Condition (top priority)	0: Normally open (Normally OFF=0) 1: Normally close (Normally ON=1) 2 to 9: Internal event 1 to 8 10 to 13: Undefined. 14: MV1 (ON/OFF, Time proportional 1, Heat-side, OPEN-side output) 15: MV2 (Time proportional 2, Cool-side, CLOSE-side output) 16 to 17: Undefined. 18 to 21: DI1 to DI4 22 to 25: Undefined. 26 to 30: Internal contact 1 to 5 31 to 33: Undefined. 34 to 37: Communication DI1 to DI4 38: MANUAL 39: READY 40: RSP 41: AT 42: During ramp 43: Undefined. 44: Alarm 45: PV alarm 46: Undefined. 47: [mode] key pressing status 48: Event output 1 terminal status 49: Control output 1 terminal status	39	2	

(Continue on next page.)

Chapter 6. LIST OF DISPLAYS AND SETTING DATA

Display	Item	Contents	Initial value	User level	Notes
[82	Multi Status (MS) display, Status (top priority)	0: Lit. 1: Slow flashing 2: Flashing twice 3: Fast flashing 4: Left to right 5: Right to left 6: Reciprocating between left and right 7: Deviation OK 8: Deviation graph 9: MV graph 10: Heat-side MV graph (For heat/cool control) 11: Cool-side MV graph (For heat/cool control) 12: MFB graph (including MFB being estimated) 13: DI monitor 14: Internal contact monitor 15: Internal event monitor	1	2	
[83	Multi Status (MS) display, Condition (second priority)	Same as Multi Status (MS) display, Condition (top priority)	44	2	
[84	Multi Status (MS) display, Status (second priority)	Same as Multi Status (MS) display, Status (top priority)	6	2	
[85	Multi Status (MS) display, Condition (third priority)	Same as Multi Status (MS) display, Condition (top priority)	1	2	
[86	Multi Status (MS) display, Status (third priority)	Same as Multi Status (MS) display, Status (top priority)	9	2	
[87	Multi Status (MS) display, deviation range	0 to 9999U	5	2	
[88	Special function	0 to 15 (This value becomes "0" when the power is turned ON.)	0	2	
[89	Zener barrier adjustment	The value can be changed with the adjustment. The numeric value cannot be directly input with the manual operation.	0.00	2	Displayed when the PV range type is RTD and the special function (C88) is set at "5".
[90	Number of CT1 turns	0: 800 turns 1 to 40: CT turns divided by 100.	8	2	If the controller model has 2 current transformer inputs, this setting is displayed.
[91	Number of CT1 power wire loops	0: 1 time 1 to 6: Number of times	1	2	
[92	Number of CT2 turns	0: 800 turns 1 to 40: CT turns divided by 100.	8	2	
[93	Number of CT2 power wire loops	0: 1 time 1 to 6: Number of times	1	2	
[97	PV input failure (under range) type	0: -10 %FS 1: -5 mV	0	0	If ROM version 1 in the instrument information bank ([802] is 2.26 or earlier, this item cannot be selected.

⚠ Handling Precautions

- If ROM version 1 of the instrument information bank ([802] is prior to 2.04, the setting options for [Number of CT1 turns], [Number of CT1 power wire loops], [Number of CT2 turns] and [Number of CT2 power wire loops] are not displayed.

■ Event configuration bank

Bank selection: *EUCF*

Display	Item	Contents	Initial value	User level	Notes
<i>E 1.1</i>	Internal Event 1 Configuration 1 Operation type	0: No event 1: PV high limit 2: PV low limit 3: PV high/low limit 4: Deviation high limit 5: Deviation low limit 6: Deviation high/low limit 7: Deviation high limit (Final SP reference) 8: Deviation low limit (Final SP reference) 9: Deviation high/low limit (Final SP reference) 10: SP high limit 11: SP low limit 12: SP high/low limit 13: MV high limit 14: MV low limit 15: MV high/low limit 16: CT1 heater burnout/over-current 17: CT1 heater short-circuit 18: CT2 heater burnout/over-current 19: CT2 heater short-circuit 20: Loop diagnosis 1 21: Loop diagnosis 2 22: Loop diagnosis 3 23: Alarm (status) 24: READY (status) 25: MANUAL (status) 26: RSP (status) 27: During AT execution (status) 28: During SP ramp (status) 29: Control direct action (status) 30: ST setting standby (status) (Invalid in this unit.) 31: During estimate of motor opening (status) 32: Timer (status) 33: High and low limits of MFB value	0	0	
<i>E 1.2</i>	Internal Event 1 Configuration 2	Digits are assigned from right to left in the order 1, 2, 3, 4.	0000	0	
	1st digit: Direct/Reverse	0: Direct 1: Reverse			
	2nd digit: Standby	0: None 1: Standby 2: Standby + Standby at SP change			
	3rd digit: EVENT state at READY	0: Continue 1: Forced OFF			
	4th digit: Undefined	0			

⚠ Handling Precautions

- If ROM version 1 of the instrument information bank (*1.02*) is prior to 2.04, “33” cannot be set as [Internal Event configuration 1 operation type].

(Continue on next page.)

Chapter 6. LIST OF DISPLAYS AND SETTING DATA

Display	Item	Contents	Initial value	User level	Notes
<i>E 1.C 3</i>	Internal Event Configuration 3	Digits are assigned from right to left in the order 1, 2, 3, 4.	0000	2	
	1st digit: Controller alarm OR	0: None 1: Alarm direct + OR operation 2: Alarm direct + AND operation 3: Alarm reverse + OR operation 4: Alarm reverse + AND operation			
	2nd digit: Special OFF setup	0: As usual. 1: When the event set value (main setting) is "0", the event is "OFF".			
	3rd digit: Delay unit	0: 0.1s 1: 1s 2: 1min			
	4th digit: Undefined.	0			
<i>E 2.C 1</i>	Internal Event 2 Configuration 1 Operation type	Same as Internal Event 1 Configuration 1.	0	0	
<i>E 2.C 2</i>	Internal Event 2 Configuration 2 1st digit: Direct/Reverse 2nd digit: Standby 3rd digit: EVENT state at READY 4th digit: Undefined.	Same as Internal Event 1 Configuration 2.	0000	0	
<i>E 2.C 3</i>	Internal Event 2 Configuration 3 1st digit: Controller alarm OR 2nd digit: Special OFF setup 3rd digit: Delay unit 4th digit: Undefined.	Same as Internal Event 1 Configuration 3.	0000	2	
<i>E 3.C 1</i>	Internal Event 3 Configuration 1 Operation type	Same as Internal Event 1 Configuration 1.	0	0	
<i>E 3.C 2</i>	Internal Event 3 Configuration 2 1st digit: Direct/Reverse 2nd digit: Standby 3rd digit: EVENT state at READY 4th digit: Undefined.	Same as Internal Event 1 Configuration 2.	0000	0	
<i>E 3.C 3</i>	Internal Event 3 Configuration 3 1st digit: Controller alarm OR 2nd digit: Special OFF setup 3rd digit: Delay unit 4th digit: Undefined.	Same as Internal Event 1 Configuration 3.	0000	2	
<i>E 4.C 1</i>	Internal Event 4 Configuration 1 Operation type	Same as Internal Event 1 Configuration 1.	0	0	
<i>E 4.C 2</i>	Internal Event 4 Configuration 2 1st digit: Direct/Reverse 2nd digit: Standby 3rd digit: EVENT state at READY 4th digit: Undefined.	Same as Internal Event 1 Configuration 2.	0000	2	
<i>E 4.C 3</i>	Internal Event 4 Configuration 3 1st digit: Controller alarm OR 2nd digit: Special OFF setup 3rd digit: Delay unit 4th digit: Undefined.	Same as Internal Event 1 Configuration 3.	0000	2	
<i>E 5.C 1</i>	Internal Event 5 Configuration 1 Operation type	Same as Internal Event 1 Configuration 1.	0	0	

(Continue on next page.)

Display	Item	Contents	Initial value	User level	Notes
<i>E5C2</i>	Internal Event 5 Configuration 2 1st digit: Direct/ Reverse 2nd digit: Standby 3rd digit: EVENT state at READY 4th digit: Undefined.	Same as Internal Event 1 Configuration 2.	0000	0	
<i>E5C3</i>	Internal Event 5 Configuration 3 1st digit: Controller alarm OR 2nd digit: Special OFF setup 3rd digit: Delay unit 4th digit: Undefined.	Same as Internal Event 1 Configuration 3.	0000	2	
<i>E6C1</i>	Internal Event 6 Configuration 1 Operation type	Same as Internal Event 1 Configuration 1.	0	0	
<i>E6C2</i>	Internal Event 6 Configuration 2 1st digit: Direct/ Reverse 2nd digit: Standby 3rd digit: EVENT state at READY 4th digit: Undefined.	Same as Internal Event 1 Configuration 2.	0000	0	
<i>E6C3</i>	Internal Event 6 Configuration 3 1st digit: Controller alarm OR 2nd digit: Special OFF setup 3rd digit: Delay unit 4th digit: Undefined.	Same as Internal Event 1 Configuration 3.	0000	2	
<i>E7C1</i>	Internal Event 7 Configuration 1 Operation type	Same as Internal Event 1 Configuration 1.	0	0	
<i>E7C2</i>	Internal Event 7 Configuration 2 1st digit: Direct/ Reverse 2nd digit: Standby 3rd digit: EVENT state at READY 4th digit: Undefined.	Same as Internal Event 1 Configuration 2.	0000	0	
<i>E7C3</i>	Internal Event 7 Configuration 3 1st digit: Controller alarm OR 2nd digit: Special OFF setup 3rd digit: Delay unit 4th digit: Undefined.	Same as Internal Event 1 Configuration 3.	0000	2	
<i>E8C1</i>	Internal Event 8 Configuration 1 Operation type	Same as Internal Event 1 Configuration 1.	0	0	
<i>E8C2</i>	Internal Event 8 Configuration 2 1st digit: Direct/ Reverse 2nd digit: Standby 3rd digit: EVENT state at READY 4th digit: Undefined.	Same as Internal Event 1 Configuration 2.	0000	0	
<i>E8C3</i>	Internal Event 8 Configuration 3 1st digit: Controller alarm OR 2nd digit: Special OFF setup 3rd digit: Delay unit 4th digit: Undefined.	Same as Internal Event 1 Configuration 3.	0000	2	

■ DI Assignment bank

Bank selection: *di*

Display	Item	Contents	Initial value	User level	Notes
<i>di 1.1</i>	Internal Contact 1 Operation type	0: No function 1: LSP group selection (0/+1) 2: LSP group selection (0/+2) 3: LSP group selection (0/+4) 4: PID group selection (0/+1) 5: PID group selection (0/+2) 6: PID group selection (0/+4) 7: RUN/READY selection 8: AUTO/MANUAL selection 9: LSP/RSP selection 10: AT Stop/Start 11: Invalid 12: Control action direct/reverse selection (As setting/opposite operation of setting) 13: SP RAMP enabled/disabled 14: PV Hold (No-hold/Hold) 15: PV maximum value hold (No-hold/Hold) 16: PV minimum value hold (No-hold/Hold) 17: Timer Stop/Start 18: Release all DO latches (Continue/Release) 19: Advance (No-advance/Advance) 20: Step hold (No-hold/Hold)	0	0	
<i>di 1.2</i>	Internal Contact 1 Input bit function	0: Not used (Default input) 1: Function 1 ((A and B) or (C and D)) 2: Function 2 ((A or B) and (C or D)) 3: Function 3 (A or B or C or D) 4: Function 4 (A and B and C and D)	0	2	When using internal contact 1, the default input is digital input (DI) 1.

(Continue on next page.)

Display	Item	Contents	Initial value	User level	Notes
<i>d1 13</i>	Internal Contact 1 Input assignment A	0: Normally opened. (OFF, 0) 1: Normally closed. (ON, 1) 2: DI1 3: DI2 4: DI3 5: DI4	2	2	Displayed when internal contact 1 Input bit function is set 1 to 4 (DI1.2≠0).
<i>d1 14</i>	Internal Contact 1 Input assignment B	6 to 9: Undefined. 10: Internal Event 1 11: Internal Event 2 12: Internal Event 3	0	2	
<i>d1 15</i>	Internal Contact 1 Input assignment C	13: Internal Event 4 14: Internal Event 5 15: Internal Event 6 16: Internal Event 7 17: Internal Event 8	0	2	
<i>d1 16</i>	Internal Contact 1 Input assignment D	18: Communication DI1 19: Communication DI2 20: Communication DI3 21: Communication DI4 22: MANUAL mode 23: READY mode 24: RSP mode 25: AT running 26: During SP ramp 27: Undefined. 28: Alarm occurs. 29: PV alarm occurs. 30: Undefined. 31: mode key pressing status 32: Event output 1 status 33: Control output 1 status	0	2	
<i>d1 17</i>	Internal Contact 1 Polarity A to D 1st digit: Polarity A (Polarity of Input assignment A) 2nd digit: Polarity B (Polarity of Input assignment B) 3rd digit: Polarity C (Polarity of Input assignment C) 4th digit: Polarity D (Polarity of Input assignment D)	Digits are assigned from right to left in the order 1, 2, 3, 4. 0: Direct 1: Reverse	0000	2	
<i>d1 18</i>	Internal Contact 1 Polarity	0: Direct 1: Reverse	0	2	
<i>d1 19</i>	Internal Contact 1 Event channel def.	0: Every Internal Event 1 to 8: Internal Event No.	0	2	Displayed when the operation type of internal contact 1 is timer stop/start (DI1.1 = 17).
<i>d1 21</i>	Internal Contact 2 Operation type	Same as Internal Contact 1 Operation type.	0	0	
<i>d1 22</i>	Internal Contact 2 Input bit function	Same as Internal Contact 1 Input bit function. 0: Not used. (Default input) 1 to 4: Function 1 to 4	0	2	When using internal contact 2, the default input is digital input (DI) 2.

(Continue on next page.)

Chapter 6. LIST OF DISPLAYS AND SETTING DATA

Display	Item	Contents	Initial value	User level	Notes
<i>d1 23</i>	Internal Contact 2 Input assignment A	Same as Internal Contact 1 Input assignment A to D.	3	2	Displayed when internal contact 2 Input bit function is set 1 to 4 (DI2.2≠0).
<i>d1 24</i>	Internal Contact 2 Input assignment B		0	2	
<i>d1 25</i>	Internal Contact 2 Input assignment C		0	2	
<i>d1 26</i>	Internal Contact 2 Input assignment D		0	2	
<i>d1 27</i>	Internal Contact 2 Polarity A to D 1st digit: Polarity A 2nd digit: Polarity B 3rd digit: Polarity C 4th digit: Polarity D	Same as Internal Contact 1 Polarity A to D The following setting applies to each digit: 0: Direct 1: Reverse	0000	2	
<i>d1 28</i>	Internal Contact 2 Polarity	0: Direct 1: Reverse	0	2	
<i>d1 29</i>	Internal Contact 2 Event channel def.	0: Every Internal Event 1 to 8: Internal Event No.	0	2	Displayed when the operation type of internal contact 2 is timer stop/start (DI2.1 = 17).
<i>d1 31</i>	Internal Contact 3 Operation type	Same as Internal Contact 1 Operation type.	0	0	
<i>d1 32</i>	Internal Contact 3 Input bit function	Same as Internal Contact 1 Input bit function. 0: Not used. (Default input) 1 to 4: Function 1 to 4	0	2	When using internal contact 3, the default input is digital input (DI) 3.
<i>d1 33</i>	Internal Contact 3 Input assignment A	Same as Internal Contact 1 Input assignment A to D.	4	2	Displayed when internal contact 3 Input bit function is set 1 to 4 (DI3.2≠0).
<i>d1 34</i>	Internal Contact 3 Input assignment B		0	2	
<i>d1 35</i>	Internal Contact 3 Input assignment C		0	2	
<i>d1 36</i>	Internal Contact 3 Input assignment D		0	2	
<i>d1 37</i>	Internal Contact 3 Polarity A to D 1st digit: Polarity A 2nd digit: Polarity B 3rd digit: Polarity C 4th digit: Polarity D	Same as Internal Contact 1 Polarity A to D The following setting applies to each digit: 0: Direct 1: Reverse	0000	2	
<i>d1 38</i>	Internal Contact 3 Polarity	0: Direct 1: Reverse	0	2	
<i>d1 39</i>	Internal Contact 3 Event channel def.	0: Every Internal Event 1 to 8: Internal Event No.	0	2	Displayed when the operation type of internal contact 3 is timer stop/start (DI3.1 = 17).
<i>d1 41</i>	Internal Contact 4 Operation type	Same as Internal Contact 1 Operation type.	0	0	
<i>d1 42</i>	Internal Contact 4 Input bit function	Same as Internal Contact 1 Input bit function. 0: Not used. (Default input) 1 to 4: Function 1 to 4	0	2	When using internal contact 4, the default input is digital input (DI) 4.

(Continue on next page.)

Display	Item	Contents	Initial value	User level	Notes
<i>d1 4.3</i>	Internal Contact 4 Input assignment A	Same as Internal Contact 1 Input assignment A to D.	5	2	Displayed when internal contact 4 input bit function is set 1 to 4 (DI4.2≠0).
<i>d1 4.4</i>	Internal Contact 4 Input assignment B		0	2	
<i>d1 4.5</i>	Internal Contact 4 Input assignment C		0	2	
<i>d1 4.6</i>	Internal Contact 4 Input assignment D		0	2	
<i>d1 4.7</i>	Internal Contact 4 Polarity A to D 1st digit: Polarity A 2nd digit: Polarity B 3rd digit: Polarity C 4th digit: Polarity D	Same as Internal Contact 1 Polarity A to D The following setting applies to each digit: 0: Direct 1: Reverse	0000	2	
<i>d1 4.8</i>	Internal Contact 4 Polarity	0: Direct 1: Reverse	0	2	
<i>d1 4.9</i>	Internal Contact 4 Event channel def.	0: Every Internal Event 1 to 8: Internal Event No.	0	2	Displayed when the operation type of internal contact 4 is timer stop/start (DI4.1 = 17).
<i>d1 5.1</i>	Internal Contact 5 Operation type	Same as Internal Contact 1 Operation type.	0	0	
<i>d1 5.2</i>	Internal Contact 5 Input bit function	Same as Internal Contact 1 Input bit function. 0: Not used. (Default input) 1 to 4: Function 1 to 4	0	2	When using internal contact 4, the default input is invalid.
<i>d1 5.3</i>	Internal Contact 5 Input assignment A	Same as Internal Contact 1 Input assignment A to D.	0	2	Displayed when internal contact 5 input bit function is set 1 to 4 (DI5.2≠0).
<i>d1 5.4</i>	Internal Contact 5 Input assignment B		0	2	
<i>d1 5.5</i>	Internal Contact 5 Input assignment C		0	2	
<i>d1 5.6</i>	Internal Contact 5 Input assignment D		0	2	
<i>d1 5.7</i>	Internal Contact 5 Polarity A to D 1st digit: Polarity A 2nd digit: Polarity B 3rd digit: Polarity C 4th digit: Polarity D	Same as Internal Contact 1 Polarity A to D The following setting applies to each digit: 0: Direct 1: Reverse	0000	2	
<i>d1 5.8</i>	Internal Contact 5 Polarity	0: Direct 1: Reverse	0	2	
<i>d1 5.9</i>	Internal Contact 5 Event channel def.	0: Every Internal Event 1 to 8: Internal Event No.	0	2	Displayed when the operation type of internal contact 5 is timer stop/start (DI5.1 = 17).

■ DO Assignment bank

Bank selection: *do*

Display	Item	Contents	Initial value	User level	Notes
<i>ot 11</i>	Control output 1 Operation type	0: Default output 1: MV 1 (ON/OFF control output, time proportional output, and time proportional output (heat) of Heat/Cool control.) 2: MV2 (Time proportional output (cool) of Heat/Cool control) 3: Function 1 ((A and B) or (C and D)) 4: Function 2 ((A or B) and (C or D)) 5: Function 3 (A or B or C or D) 6: Function 4 (A and B and C and D)	0	2	Displayed when control output 1 of the model is relay output or voltage pulse output. When using control output 1, the default output is MV1.
<i>ot 12</i>	Control output 1 Output assignment A	0: Normally opened. (OFF, 0) 1: Normally closed. (ON, 1) 2: Internal Event 1 3: Internal Event 2 4: Internal Event 3 5: Internal Event 4 6: Internal Event 5 7: Internal Event 6 8: Internal Event 7 9: Internal Event 8 10 to 13: Undefined. 14: MV1 15: MV2 16 to 17: Undefined. 18: DI1 19: DI2 20: DI3 21: DI4	14	2	Displayed when control output 1 of the model is relay output or voltage pulse output, and the operation type of control output 1 is set 1 to 4 (<i>ot1.1</i> > 2).
<i>ot 13</i>	Control output 1 Output assignment B	22 to 25: Undefined. 26: Internal Contact 1 27: Internal Contact 2 28: Internal Contact 3 29: Internal Contact 4 30: Internal Contact 5 31 to 33: Undefined. 34: Communication DI1 35: Communication DI2 36: Communication DI3 37: Communication DI4 38: MANUAL mode 39: READY mode 40: RSP mode 41: AT running 42: During SP ramp 43: Undefined. 44: Alarm occurs. 45: PV alarm occurs. 46: Undefined. 47: mode key pressing status 48: Event output 1 status 49: Control output 1 status	0	2	
<i>ot 14</i>	Control output 1 Output assignment C		0	2	
<i>ot 15</i>	Control output 1 Output assignment D		0	2	
<i>ot 16</i>	Control output 2 Polarity A to D 1st digit: Polarity A 2nd digit: Polarity B 3rd digit: Polarity C 4th digit: Polarity D	Digits are assigned from right to left in the order 1, 2, 3, 4. 0: Direct 1: Reverse	0000	2	
<i>ot 17</i>	Control output 1 Polarity	0: Direct 1: Reverse	0	2	
<i>ot 18</i>	Control output 1 Latch	0: None 1: Latch (Latch at ON) 2: Latch (Latch at OFF except for initialization at power ON)	0	2	

(Continue on next page.)

Display	Item	Contents	Initial value	User level	Notes
ot2.1	Control output 2 Operation type	Same as Control output 1 Operation type. 0: Default output 1: MV1 2: MV2 3 to 6: Function 1 to 4	0	2	Displayed when the control output of the model is set to the position proportional output or the control output 2 of the model is voltage pulse output. When using control output 2, the default output is MV2.
ot2.2	Control output 2 Output assignment A	Same as Control output 1 Output assignment A to D.	15	2	Displayed when control output 2 of the model is set to the voltage pulse output and the operation type of control output 2 is set 1 to 4 (ot2.1 > 2).
ot2.3	Control output 2 Output assignment B		0	2	
ot2.4	Control output 2 Output assignment C		0	2	
ot2.5	Control output 2 Output assignment D		0	2	
ot2.6	Control output 2 Polarity A to D 1st digit: Polarity A 2nd digit: Polarity B 3rd digit: Polarity C 4th digit: Polarity D	Same as Control output 1 Polarity A to D. The following setting applies to each digit: 0: Direct 1: Reverse	0000	2	
ot2.7	Control output 2 Polarity	0: Direct 1: Reverse	0	2	
ot2.8	Control output 2 Latch	0: None 1: Latch (Latch at ON) 2: Latch (Latch at OFF except for initialization at power ON)	0	2	
Ev1.1	Event output 1 Operation type	Same as Control output 1 Operation type. 0: Default output 1: MV1 2: MV2 3 to 6: Function 1 to 4	0	2	Displayed when the optional model has Event output 1. When using Event output 1, the default output is Internal Event 1.
Ev1.2	Event output 1 Output assignment A	Same as Control output 1 Output assignment A to D.	2	2	Displayed when the optional model has Event output 1 and the operation type of Event output 1 is set 1 to 4 (Ev1.1 > 2).
Ev1.3	Event output 1 Output assignment B		0	2	
Ev1.4	Event output 1 Output assignment C		0	2	
Ev1.5	Event output 1 Output assignment D		0	2	
Ev1.6	Event output 1 Polarity A to D 1st digit: Polarity A 2nd digit: Polarity B 3rd digit: Polarity C 4th digit: Polarity D	Same as Control output 1 Polarity A to D. The following setting applies to each digit: 0: Direct 1: Reverse	0000	2	
Ev1.7	Event output 1 Polarity	0: Direct 1: Reverse	0	2	
Ev1.8	Event output 1 Latch	0: None 1: Latch (Latch at ON) 2: Latch (Latch at OFF except for initialization at power ON)	0	2	

(Continue on next page.)

Chapter 6. LIST OF DISPLAYS AND SETTING DATA

Display	Item	Contents	Initial value	User level	Notes
Ev2.1	Event output 2 Operation type	Same as Control output 1 Operation type. 0: Default output 1: MV1 2: MV2 3 to 6: Function 1 to 4	0	2	Displayed when the optional model has Event output 2. When using Event output 2, the default output is Internal Event 2.
Ev2.2	Event output 2 Output assignment A	Same as Control output 1 Output assignment A to D.	3	2	
Ev2.3	Event output 2 Output assignment B		0	2	
Ev2.4	Event output 2 Output assignment C		0	2	
Ev2.5	Event output 2 Output assignment D		0	2	
Ev2.6	Event output 2 Polarity A to D 1st digit: Polarity A 2nd digit: Polarity B 3rd digit: Polarity C 4th digit: Polarity D	Same as Control output 1 Polarity A to D. The following setting applies to each digit: 0: Direct 1: Reverse	0000	2	
Ev2.7	Event output 2 Polarity	0: Direct 1: Reverse	0	2	
Ev2.8	Event output 2 Latch	0: None 1: Latch (Latch at ON) 2: Latch (Latch at OFF except for initialization at power ON)	0	2	
Ev3.1	Event output 3 Operation type	Same as Control output 1 Operation type. 0: Default output 1: MV1 2: MV2 3 to 6: Function 1 to 4	0	2	Displayed when the optional model has Event output 3. When using Event output 3, the default output is Internal Event 3.
Ev3.2	Event output 3 Output assignment A	Same as Control output 1 Output assignment A to D.	4	2	Displayed when the optional model has Event output 3 and the operation type of Event output 3 is set 1 to 4 (Ev3.1 > 2).
Ev3.3	Event output 3 Output assignment B		0	2	
Ev3.4	Event output 3 Output assignment C		0	2	
Ev3.5	Event output 3 Output assignment D		0	2	
Ev3.6	Event output 3 Polarity A to D 1st digit: Polarity A 2nd digit: Polarity B 3rd digit: Polarity C 4th digit: Polarity D	Same as Control output 1 Polarity A to D. The following setting applies to each digit: 0: Direct 1: Reverse	0000	2	
Ev3.7	Event output 3 Polarity	0: Direct 1: Reverse	0	2	
Ev3.8	Event output 3 Latch	0: None 1: Latch (Latch at ON) 2: Latch (Latch at OFF except for initialization at power ON)	0	2	

■ User Function bank

Bank selection: *UF*

Display	Item	Contents	Initial value	User level	Notes
<i>UF-1</i>	User Function 1	Each setting is set on the upper display.	----	1	It is possible to register only the settings, which can be displayed. (Example: Manual reset of the PID constant can be registered when the I (Integral time) is set at "0".) The registered setting is added to the end of the display order of the basic display.
<i>UF-2</i>	User Function 2	The following shows the setting exceptions:	----	1	
<i>UF-3</i>	User Function 3	---- : Not registered.	----	1	
<i>UF-4</i>	User Function 4	<i>P</i> - : Proportional band of currently used PID group	----	1	
<i>UF-5</i>	User Function 5	<i>I</i> - : Integral time of currently used PID group	----	1	
<i>UF-6</i>	User Function 6	<i>D</i> - : Derivative time of currently used PID group	----	1	
<i>UF-7</i>	User Function 7	<i>rE</i> - : Manual reset of currently used PID group	----	1	
<i>UF-8</i>	User Function 8	<i>oL</i> - : Output low limit of currently used PID	----	1	
		<i>oH</i> - : Output high limit of currently used PID group			
		<i>P</i> - <i>ℓ</i> : Proportional band for cool side of currently used PID group			
		<i>I</i> - <i>ℓ</i> : Integration time for cool side of currently used PID group			
		<i>D</i> - <i>ℓ</i> : Derivative time for cool side of currently used PID group			
		<i>oL</i> - <i>ℓ</i> : Output low limit for cool side of currently used PID group			
		<i>oH</i> - <i>ℓ</i> : Output high limit for cool side of currently used PID group			

■ Lock bank

Bank selection: *LoC*

Display	Item	Contents	Initial value	User level	Notes
<i>LoC</i>	Key lock	0: All settings are possible. 1: Mode, event, operation display, SP, UF, lock, and manual MV can be set. 2: Operation display, SP, UF, lock, and manual MV can be set. 3: UF, lock, and manual MV can be set.	0	0	When two sets of passwords (1A and 1B, 2A and 2B) are matched, the setting is possible. [mode] key operation, MV setting in MANUAL mode, key lock, password display, and password 1A to 2B can be set when the key lock (LoC) is a value of 0 to 3.
<i>CLoC</i>	Communication lock	0: RS-485 communication read/write enabled. 1: RS-485 communication read/write disabled.	0	2	
<i>LLoC</i>	Loader lock	0: Loader communication read/write enabled. 1: Loader communication read/write disabled.	0	2	
<i>PASS</i>	Password display	0 to 15 5: Password 1A to 2B display	0	0	
<i>P51A</i>	Password 1A	0000 to FFFF (Hexadecimal value)	0000	0	Displayed when the password display (PASS) is "5" and two sets of passwords (1A and 1B, 2A and 2B) are matched.
<i>P52A</i>	Password 2A	0000 to FFFF (Hexadecimal value)	0000	0	
<i>P51B</i>	Password 1B	0000 to FFFF (Hexadecimal value)	0000	0	Displayed when the password display (PASS) is "5".
<i>P52B</i>	Password 2B	0000 to FFFF (Hexadecimal value)	0000	0	

■ Instrument information bank

Bank selection: *Id*

Display	Item	Contents	Initial value	User level	Notes
<i>Id01</i>	ROM ID	2 fixed	—	2	Identification of ROM firmware setting is disabled.
<i>Id02</i>	ROM Version 1	XX.XX (2 digits after decimal point)	—	2	
<i>Id03</i>	ROM Version 2	XX.XX (2 digits after decimal point)	—	2	
<i>Id04</i>	LOADER Information		—	2	
<i>Id05</i>	EST Information		—	2	
<i>Id06</i>	Manufacturing date code (year)	Year - 2000 Example: "3" means the year 2003.	—	2	Manufacturing date and unit identification No. setting is disabled.
<i>Id07</i>	Manufacturing date code (month, day)	Month + Day ÷ 100. Example: "12.01" means the 1st day of December.	—	2	
<i>Id08</i>	Serial No.		—	2	

Chapter 7. CPL COMMUNICATION FUNCTION

7 - 1 Outline of Communication

If the optional model is provided with the RS-485 communication function, communication with a PC, PLC or other host devices are available using a user-configured program.

The communication protocol can be selected from the Controller Peripheral Link (CPL) communication (Azbil Corporation's host communication protocol) and the Modbus communication. This chapter describes the CPL communications.

■ Features

The features of the SDC35/36's communication function are as follows:

- Up to 31 units can be connected to a single master station as a host device.
- When the communication specifications of the host device conform to the RS-232C interface, the communication converter CMC10L (sold separately) is required. The CMC10L allows the conversion between RS-232C and RS-485.
- Almost all of the device parameters can be communicated.

For details on communication parameters,

➞ Chapter 9, LIST OF COMMUNICATION DATA.

- Random access commands are available.

Two or more number of parameters at separated addresses can be read or written by a single command.

■ Setup

The following setups are required for performing the CPL communications:

The items on the table below can be displayed and set up only when the optional model number is provided with the RS-485 communication function.

Item (Setting display/bank)	Display	Contents	Initial value	User level
CPL/Modbus (Setup setting/Setup bank)	Ⓒ 54	0: CPL 1: Modbus ASCII format 2: Modbus RTU format	0	Basic, Standard, High function
Station address (Same as above)	Ⓒ 55	0: Does not communicate 1 to 127	0	
Transmission speed (Same as above)	Ⓒ 56	0: 4800bps 1: 9600bps 2: 19200bps 3: 38400bps	2	
Data format (Data length) (Same as above)	Ⓒ 57	0: 7 bits 1: 8 bits	1	
Data format (Parity) (Same as above)	Ⓒ 58	0: Even parity 1: Odd parity 2: No parity	0	
Data format (Stop bit) (Same as above)	Ⓒ 59	0: 1 stop bit 1: 2 stop bits	0	
Response time-out	Ⓒ 70	1 to 250ms	3	High function

⚠ Handling Precautions

- Setups can be performed through key operation on the console or the SLP-C35 Smart Loader Package. However, they cannot be performed via RS-485 communications.
- If you use the Azbil Corporation CMC10L as an RS-232C/RS-485 converter, set the response time-out (C70) to 3ms or longer.

■ Communication procedures

The communication procedure is as follows:

- (1) The instruction message is sent from the host device (master station) to one unit (slave station) to communicate with.
- (2) The slave station receives the instruction message, and performs read or write processing according to the content of the message.
- (3) The slave station sends a message corresponding to the processing content as a response message.
- (4) The master station receives the response message.

❗ Handling Precautions

It is not allowed to use two or more number of protocols together on a single RS-485 transmission line such as CPL, Modbus ASCII format, and Modbus RTU format.

● List of data link layer data definitions

The following list shows the definitions for data in the data link layer:

Data name	Character code	Number of characters	Meaning of data
STX	02H	1	Start of message
Station address	0 to 7FH are expressed as hexadecimal character codes.	2	Identification of device to communicate with
Sub-address	"00" (30H, 30H)	2	No function
Device code	"X" (58H) or "x" (78H)	1	Device type
ETX	ETX (03H)	1	End position of the application layer
Checksum	00H to FFH are expressed as two-digit hexadecimal character codes.	2	Checksum of message
CR	0DH	1	End of message (1)
LF	0AH	1	End of message (2)

● Description of data items

- STX (02H)

When STX is received, the device judges this to be the start of the send message. For this reason, the device returns to the initial state whatever reception state it was in, and processing is started on the assumption that the STX, the first character, has been received. The purpose of this is to enable recovery of the device's response at the next correct message (e.g. RETRY message) from the master station in the event that noise, for example, causes an error in the sent message.

- Station address

Of the messages sent by the master station, the device creates response messages only when station addresses are the same. Station addresses in the messages are expressed as two-digit hexadecimal characters.

The station address is set up by the station address setup (setup setting C65).

However, when the station address is set to 0 (30H 30H), the device creates no response even if station addresses match.

The device returns the same station address as that of the received message.

- Sub-address

The C35/36 does not use the sub-address. For this reason, set "00" (30H 30H).

The device returns the same sub-address as that of the received message.

- Device code

The device sets X (58H) or x (78H) as the device code. This code is determined for each device series, and other codes cannot be selected. The device returns the same device code as that of the received message. X (58H) is used as the default, and x (78H) is used for judging the message as the resend message.

- ETX

ETX indicates the end of the application layer.

- Checksum

This value is for checking whether or not some abnormality (e.g. noise) causes the message content to change during communications.

The checksum is expressed as two hexadecimal characters.

- How to calculate a checksum

- (1) Add the character codes in the message from STX through ETX in single byte units.
- (2) Take two's complement of the low-order one byte of the addition result.
- (3) Convert the obtained two's complement to a two-byte ASCII code.

The following is a sample checksum calculation:

[Sample message]

```

STX: 02H
'0': 30H (1st byte of the station address)
'1': 31H (2nd byte of the station address)
'0': 30H (1st byte of the sub-address)
'0': 30H (2nd byte of the sub-address)
'X': 58H (device code)
'R': 52H (1st byte of the command)
'S': 53H (2nd byte of the command)
',': 2CH (3rd byte of the command)
'1': 31H (4th byte of the command)
'5': 35H (5th byte of the command)
'0': 30H (6th byte of the command)
'1': 31H (7th byte of the command)
'W': 57H (8th byte of the command)
',': 2CH (9th byte of the command)
'1': 31H (10th byte of the command)
(omitted)
ETX: 03H

```

- (1) Add the character codes in the message from STX through ETX in single byte units.

The add operation in single byte units is as follows:

$$02H + 30H + 31H + 30H + 30H + 58H + 52H + 53H + \dots + 03H.$$

Assume that the result is 376H.

- (2) The low-order one byte of the addition result 376H is 76H. The two's complement of 76H is 8AH.
- (3) Convert the obtained 8AH to a two-byte ASCII code.

The result is:

'8': 38H

'A': 41H,

and the two bytes, '8'(38H) and 'A'(41H), are the checksum.

- CR/LF

This indicates the end of the message. Immediately after LF is received, the device enters a state allowed to process the received message.

■ **Application layer**

The table below shows the configuration of the application layer.

Item	Description
Command	"RS" (decimal number format continuous address data read command)
	"WS" (decimal number format continuous address data write command)
	"RD" (hexadecimal number format continuous address data read command)
	"WD" (hexadecimal number format continuous address data write command)
	"RU" (hexadecimal number format random address data read command)
	"WU" (hexadecimal number format random address data write command)
Data delimiter	RS, WS: "," (comma) Other commands: None
Word address	RS, WS: "501W", etc. Other commands: "01F5", etc.
Read count	Numerical value of characters expressed as "1" for example
Numerical value to be written	RS, WS: Numerical value of characters expressed as "100" for example Other commands: Numerical value of characters expressed in hexadecimal as "0064" for example

7 - 3 Description of Commands

■ Continuous data read command (RS command)

This command reads data of continuous addresses by a single command.

● Send message

This command enables the content of continuous data addresses starting with the specified read start address to be read as a single message. The figure below shows the structure of the application layer of the send message when the data is read.

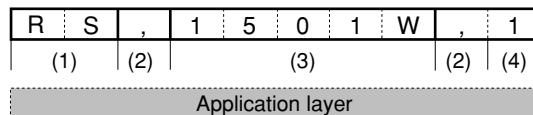

- (1) Continuous read command
- (2) Data delimiter
- (3) Data address
- (4) Number of read data

● Response message

If the message is correctly received, a response message corresponding to the command content is returned.

The figure below shows the structure of the application layer of the response message when the data is read.

- Normal termination (reading of single data item)

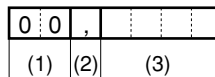

- Normal termination (reading of multiple data items)

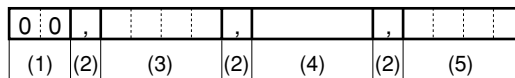

- Abnormal termination



The abnormal termination code is entered at XX.
For details of codes,
 7-6, List of Termination Codes (on page 7-15).

- (1) Termination code
- (2) Data delimiter
- (3) Data
- (4) Data 2 to (n-1)
- (5) Data n

● Maximum number of read data per message

Up to 16 words for both RAM and EEPROM areas

■ Continuous data write command (WS command)

This command writes data to continuous addresses.

● Send message

The figure below shows the structure of the application layer of the send message for the data write command.

W	S	,	1	5	0	1	W	,	1	,	6	5
(1)	(2)		(3)				(2)	(4)	(2)		(5)	

- (1) Write command
- (2) Data delimiter
- (3) Start write data address
- (4) Write data (first word)
- (5) Write data (second word)

● Response message

The figure below shows the structure of the application layer of the response message for the data write command.

- Normal termination

0	0
(1)	

- Abnormal termination or warning

X	X
(1)	

The abnormal termination code is entered at XX.
For details of codes,
 7-6, List of Termination Codes (on page 7-15).

- (1) Termination code

● Maximum number of write data per message

Up to 16 words for both RAM and EEPROM areas

■ **Fixed length continuous data read command (RD command)**

This command reads continuous data in two-byte units. This command is suitable for handling data in ladder programs sent by PLC communications as the data is of a fixed length.

The start data address is expressed as four hexadecimal digits. The number of read data is expressed as four digits, and data is expressed as four X n (n is a positive integer) hexadecimal digits.

● **Send message**

The read start data address (four hexadecimal digits) and the number of read data (four hexadecimal digits) are sent.

R	D						
(1)	(2)	(3)					

- (1) Fixed length continuous data read command
- (2) Start data address
- (3) Number of read data

● **Response message**

If the message is sent successfully, the termination code is taken to be normal (two decimal digits) and returned appended with the number of read data (four hexadecimal digits X number of read data) specified by the command. If message transmission ends in error, the termination code is taken to be in error (two decimal digits) and returned without the read data.

- Normal termination (reading of single data item)

0	0				
(1)	(2)				

- Normal termination (reading of multiple data items)

0	0						
(1)	(2)	(3)	(4)				

- Abnormal termination

X	X
(1)	

The abnormal termination code is entered at XX.
 For details of codes,  7-6, List of Termination Codes (on page 7-15).

- (1) Termination code
- (2) Data
- (3) Data 2 to data (n-1)
- (4) Data n

● **Maximum number of read data per message**

Up to 28 words for both RAM and EEPROM areas

■ Fixed length continuous data write command (WD command)

This command writes continuous data in two-byte units. This command is suitable for handling data in ladder programs sent by PLC communications as the data is of a fixed length.

The start data address is expressed as four hexadecimal digits. Data is expressed as four X n (n is a positive integer) hexadecimal digits.

● Send message

The write start data address (four hexadecimal digits) and the number of write data (four X n hexadecimal digits) are sent.

- Writing of single data item

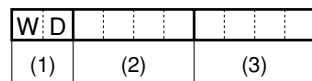

- Writing of multiple data items

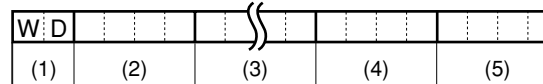

- (1) Fixed length continuous data write command
- (2) Start data address
- (3) Data 1
- (4) Data 2 to data (n-1)
- (5) Data n

● Response message

If writing is successful, the normal termination code (two decimal digits) is returned. If only part of the data is written, and the remaining data is not written, the warning termination code (two decimal digits) is returned. If none of the data is written, the abnormal termination code (two decimal digits) is returned.

- Normal termination



- Abnormal termination or warning



The abnormal termination code is entered at XX.
For details of codes, 7-6, List of Termination Codes (on page 7-15).

- (1) Termination code

● Maximum number of write data per message

RAM area: Up to 27 words

EEPROM area: Up to 16 words

■ Fixed length random data read command (RU command)

This command reads random data in two-byte units.

● Send message

The data address (four hexadecimal digits) of the data to be read is sent in the specified order.

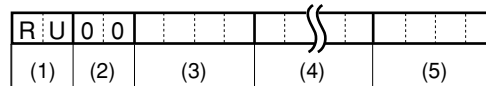

- (1) Fixed length random data write command
- (2) Sub-command: fixed to "00".
- (3) Data address 1
- (4) Data address 2
- (5) Data address n

● Response message

If the message is sent successfully, the termination code is taken to be normal (two decimal digits) and returned appended with the number of read data (four hexadecimal digits X number of read data) specified by the command. If message transmission ends in error, the termination code is taken to be in error (two decimal digits) and returned without the read data.

• Normal termination

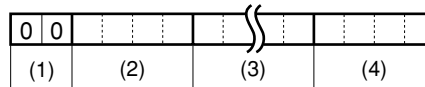

• Abnormal termination

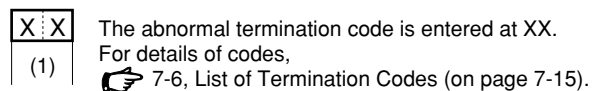

- (1) Termination code
- (2) Data 1
- (3) Data 2 to data (n-1)
- (4) Data n

● Maximum number of read data per message

Up to 28 words for both RAM and EEPROM areas

■ **Fixed length random data write command (WU command)**

This command writes data to random addresses in two-byte units. Data is expressed in four hexadecimal digits.

● **Send message**

Data is sent for the specified number of write data with the data address (four hexadecimal digits) of the data to be written and the data (four hexadecimal digits) as a pair.

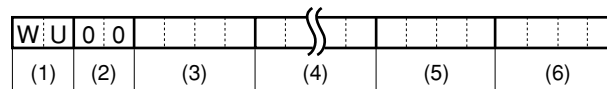

- (1) Fixed length random data write command
- (2) Sub-command: fixed to "00".
- (3) Data address 1
- (4) Write data 1
- (5) Data address n
- (6) Write data n

● **Response message**

If writing is successful, the normal termination code (two decimal digits) is returned. If only part of the data is written, and the remaining data is not written, the warning termination code (two decimal digits) is returned. If none of the data is written, the abnormal termination code (two decimal digits) is returned.

- Normal termination



- Abnormal termination or warning

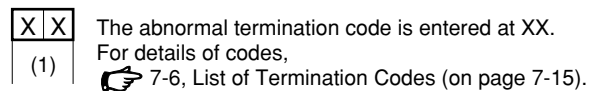

- (1) Termination code

● **Maximum number of write data per message**

Up to 14 words for both RAM and EEPROM areas

7 - 4 Definition of Data Addresses

- **RAM and EEPROM areas of data addresses**

Data addresses are categorized as follows:

Data address (hexadecimal notation)	Name	Notes
273W to 14859W (0111 to 3A0B)	RAM access data address	Reading and writing of these addresses are both performed on RAM. Since writing is not performed to EEPROM, the value returns to that stored in EEPROM after restarted.
16657W to 31243W (4111 to 7A0B)	EEPROM access data address	Writing is performed to both RAM and EEPROM; reading is performed only on RAM. Since writing is also performed to EEPROM, the value does not change even after restarted.

 **Handling Precautions**

EEPROM's erase/write cycles are limited to about 100,000. Accordingly, it is recommended that very frequently written parameters be written to RAM, which does not have a limitation on cycles.

Note, with regard to writing to RAM, that data in EEPROM is transferred to RAM when the power is turned ON again.

- **Write data range**

If the write value exceeds the range determined by parameters, writing is not performed and an abnormal termination code is returned.

- **Write conditions**

An abnormal termination code is also returned when the writing is not possible due to the conditions.

7 - 5 Numeric Representation in the Application Layer

The specifications of numeric representation are decimal variable-length (zero suppress) for RS and WS commands and hexadecimal fixed-length for RD, WD, RU and WU commands. Details are as follows:

● RS and WS commands

Item	Specifications	Remedies
Unwanted space	Cannot be appended.	The message processing is aborted and an abnormal termination code is returned as a response message.
Unwanted zero	Cannot be appended.	
Numerical value = zero	Cannot be omitted. Be sure to use "0".	
Other unwanted characters	Numerical values may be prefixed with a "-" expressing a negative number. Any other character cannot be appended. The "+" sign must not be appended to indicate positive numerical values.	
Range of available numerical values	-32768 to +32767 Values out of this range are not allowed.	

● RD, WD, RU and WU commands

Item	Specifications	Remedy
Unwanted space	Cannot be appended.	The message processing is aborted and an abnormal termination code is returned as a response message.
Unwanted zero	Cannot be appended.	
Numerical value = zero	Cannot be omitted. Be sure to use "0000".	
Other unwanted characters	Cannot be appended.	
Range of available numerical values	0000H to FFFFH	

7 - 6 List of Termination Codes

When an error occurred in the application layer, an abnormal termination code is returned as a response message.

Termination code	Description	Remedies	Example
00	Normal termination	All the processing has normally completed.	
99	Undefined command Other error	Only the termination code is returned but the message processing is not performed.	AA,1001W,1 RX03E80001
10	Conversion error of a numerical value <ul style="list-style-type: none"> • A numerical value of 7 digits or more • A figure other than 0 of which the leading digit is 0 • The conversion result is 65535 or greater, or -65536 or smaller. • Other obvious illegal representation of an integer 	Processing is aborted just when a conversion error or a range error has occurred. (Processing is performed just before an error has occurred.)	RS,1001W,100000 RS,01001W,1 RS,+1001W,1 WS,10?1W,1 RD03E9000> RU0103E9
22	The value of written data is out of the specified range.	Processing is continued excluding the data address with abnormal data.	(Example: Specified range for 500W is 0 to 1) (Processing aborted) WS,5001W,3000 WD13890BB8 WU0013890BB8
23	Writing disabled due to instrument set value conditions, instrument external conditions, etc.	Processing is continued excluding the data address with abnormal data.	
	Writing/reading disabled because communications/loader locked	Only the termination code is returned but the message processing is not performed.	
40	Read/write word count error	Only the termination code is returned but the message processing is not performed.	RS,1001W,100 RD03E90064
41	Data address is out of the range. <ul style="list-style-type: none"> • Out of the range between 256 and 65534 	Only the termination code is returned but the message processing is not performed.	RS,100000W,1 RD03G90001 RU00\$3E903EA WS,03E9W,1 WD0XXX0001 WU00o3E9001
42	Value of data is out of the specified range. <ul style="list-style-type: none"> • -32769 or smaller, or 32768 or greater 	Processing is performed up to the data address with abnormal data; the succeeding processing is not performed.	WS,2101W,100,XXX WS,2101W,100000 WD03E900010XXX

7 - 7 Reception and Transmission Timing

■ Timing specifications for instruction and response message

The cautions below are required with regard to the timing to transmit a instruction message from the master station and a response message from the slave station.

● Response monitor time

The maximum response time from the end of the instruction message transmission by the master station until when the master station receives a response message from the slave station is two seconds ((1) in the figure below). So, the response monitor time should be set to two seconds.

Generally, when a response time-out occurs, the instruction message is resent.

● Transmission start time

A wait time of 10ms is required before the master station starts to transmit the next instruction message (to the same slave station or a different slave station) after the end of receiving response message ((2) in the figure below).

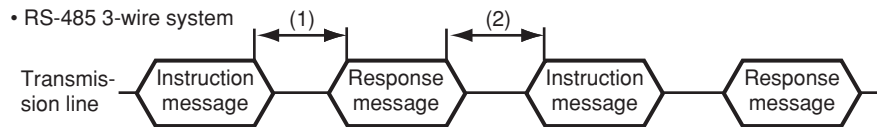

- (1) End of master station transmission -
Transmission start time of slave station = Max. 2000ms
- (2) End of slave station transmission -
Transmission start time of master station = Min. 10ms

■ RS-485 driver control timing specifications

When the transmission/reception on the RS-485 3-wire system is directly controlled by the master station, care should be paid to the following timing:

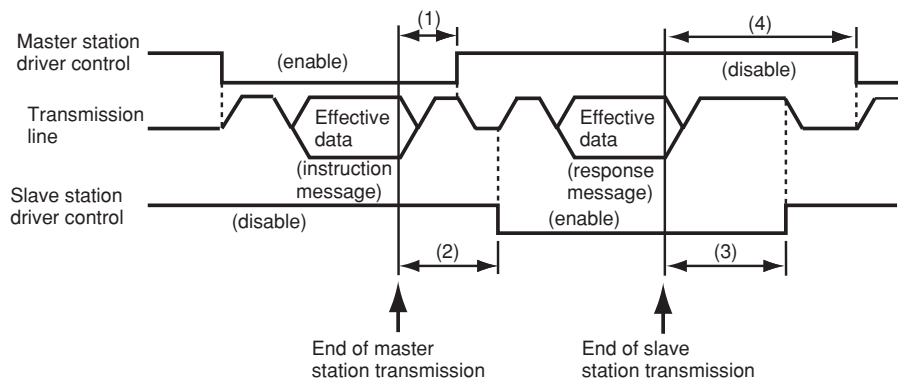

- (1) End of master station transmission - Driver disable time = Max. 500 μ s
- (2) End of slave station reception - Driver enable time = Response time-out setup setting (C70) or greater
- (3) End of slave station transmission - Driver disable time = Max. 10ms
- (4) End of master station reception - Driver enable time = Min. 10ms

7 - 8 Cautions when Making Communication Programs for the Master Station

Pay attention to the following points when making communication programs:

- The longest response time on the device is two seconds. For this reason, set the response monitor time to two seconds.
- Resend the same message if there is no response within two seconds. Set a communication error to occur if there is no response even after two retries.
- Be sure to make the above resends to guard against the case when the message cannot be send correctly due to the influence of noise, for example, during communications.



Note

When the master station resends the message, alternatively use the device ID codes "X" and "x." This is convenient as you can tell whether or not the received message is the previously received message.

■ Example of communications program

A sample program is installed in the folder in which the SLP-C35 Smart Loader Package has been installed.

In the default setting, the directory is "c:\program files\slp\slpc35\cpl.cpp". This program is written in C++. Microsoft's Visual C++ 2008 can be used to compile it.

The program is supplied for purposes of reference to assist the user in making a program, and its operation is not 100% guaranteed.

You can download Visual C++ 2008 Express Edition from the Microsoft website at <http://www.microsoft.com/express/>.



Handling Precautions

Azbil Corporation assumes no responsibility with regard to any trouble caused by using this program.

● Prior to running the sample program

Make sure to check the settings for communications type, station address, transmission speed and data format of the instrument.

● Compiling

At the Visual Studio 2008 command prompt, enter "cl" to begin compiling.

Example of compilation result

```
C:\sample>cl cpl.cpp
Microsoft(R) 32-bit C/C++ Optimizing Compiler Version 15.00.30729.01 for 80x86
Copyright (C) Microsoft Corporation. All rights reserved.

cpl.cpp
Microsoft (R) Incremental Linker Version 9.00.30729.01
Copyright (C) Microsoft Corporation. All rights reserved.

/out:cpl.exe
cpl.obj
```

● **Running the sample program**

This program is used for reading and writing data. When the program is executed, the application layers of the instruction message and response message communicated are indicated.

```
command:RS,14356W,2
result:00,0,0
command:WS,14357W,2
result:00
```

Sample indication of execution results

● **Processing of the sample program**

- Communication settings
Call `open()` and initialize the RS-232C serial port.
- Command execution
Set a desired character string in 'command' and call `AppCPL()`.

Chapter 8. Modbus COMMUNICATION FUNCTION

8 - 1 Outline of Communication

If the optional model is provided with the RS-485 communications function, communication with a PC, PLC or other host devices are available using a user-configured program.

The communication protocol can be selected from the Controller Peripheral Link (CPL) communication (Azbil Corporation's host communication protocol) and the Modbus communication. This chapter describes the Modbus communications.

■ Features

The features of the C35/36's communication function are as follows:

- Up to 31 units can be connected to a single master station as a host device.
- When the communication specifications of the host device conform to the RS-232C interface, the communication converter CMC10L (sold separately) is required. The CMC10L allows the conversion between RS-232C and RS-485.
- Almost all of the device parameters can be communicated.

For details on communication parameters,

➞ Chapter 9, LIST OF COMMUNICATION DATA.

■ Setup

The following setups are required for performing the Modbus communication:

Item (Setting display/bank)	Display	Contents	Initial value	User level
CPL/Modbus (Setup setting/Setup bank)	Ⓒ 54	0: CPL 1: Modbus ASCII format 2: Modbus RTU format	0	Basic, Standard, High function
Station address (Same as above)	Ⓒ 55	0: Does not communicate 1 to 127	0	
Transmission speed (Same as above)	Ⓒ 56	0: 4800bps 1: 9600bps 2: 19200bps 3: 38400bps	2	
Data format (Data length) (Same as above)	Ⓒ 57	0: 7 bits 1: 8 bits	1	
Data format (Parity) (Same as above)	Ⓒ 58	0: Even parity 1: Odd parity 2: No parity	0	
Data format (Stop bit) (Same as above)	Ⓒ 59	0: 1 stop bit 1: 2 stop bits	0	
Response time-out	Ⓒ 70	1 to 250ms	3	High function

- If the optional model number is provided with the RS-485 communications function, display and setup are available.
- If the communications type is set to Modbus RTU format, data format (data length) cannot be displayed nor set up, and the action is fixed to 8-bit data.

ⓘ Handling Precautions

- Setups can be performed through key operation on the console or the SLP-C35 Smart Loader Package. However, they cannot be performed via RS-485 communications.
- If you use the Azbil Corporation CMC10L as an RS-232C/RS-485 converter, set the response time-out (C70) to 3ms or longer.

■ Communication procedures

The communication procedure is as follows:

- (1) The instruction message is sent from the host device (master station) to one unit (slave station) to communicate with.
- (2) The slave station receives the instruction message, and performs read or write processing according to the content of the message.
- (3) The slave station sends a message corresponding to the processing content as a response message.
- (4) The master station receives the response message.

❗ Handling Precautions

It is not allowed to use two or more number of protocols together on a single RS-485 transmission line such as CPL, Modbus ASCII format, and Modbus RTU format.

- (2) Take two's complement of the addition result.
- (3) Convert the low-order one byte of the addition result to a character code.

The following is a sample checksum calculation:

[Sample message]

: : 3AH (start of the message)
'0' : 30H (first byte of the station address)
'A' : 41H (second byte of the station address)
'0' : 30H (first byte of the read command)
'3' : 33H (second byte of the read command)
'0' : 30H (first byte of the start data address)
'3' : 33H (second byte of the start data address)
'E' : 45H (third byte of the start data address)
'9' : 39H (fourth byte of the start data address)
'0' : 30H (first byte of the number of read data)
'0' : 30H (second byte of the number of read data)
'0' : 30H (third byte of the number of read data)
'2' : 32H (fourth byte of the number of read data)

- (1) Add the data from the top up to just before the checksum.

The add operation is as follows:

$0AH + 03H + 03H + E9H + 00H + 02H$

The result is FBH.

- (2) The low-order byte of the addition result FBH is FBH as is. The two's complement of FBH is 05H.

- (3) Convert the obtained 05H to a two-byte ASCII code.

The result is:

'0' : 30H

'5' : 35H,

and the two bytes, '0' (30H) and '5' (35H), are the checksum.

- CR/LF

This indicates the end of the message. After LF is received, the device immediately stands by for permission to process the received message.

● Modbus RTU

All messages are written in binary data.

A Modbus RTU message consists of (1) to (3) below.

The part of (2) stores commands, which are transmission contents from the master station and responses, which are transmission contents from the slave station.

All messages use binary data. (Each slot below corresponds to one character.)

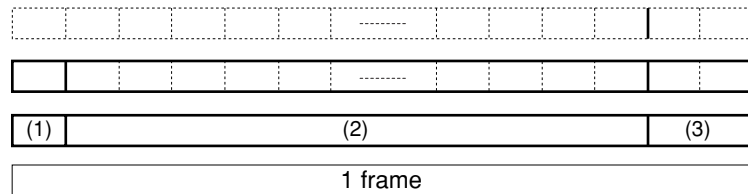

- (1) Station address (1 byte)
- (2) Send message, response message
- (3) Checksum (2 bytes)

• Station address

Of the messages sent by the master station, the device creates response messages only when station addresses are the same. Station addresses in the messages are expressed in one byte. The station address is set up by the station address setup (setup setting C65). However, when the station address is set to 0, the device creates no response even if station addresses match. The device returns the same station address as that of the received message.

• Checksum (CRC)

This value is for checking whether or not some abnormality (e.g. noise) causes the message content to change during communications. The checksum is expressed as 2 bytes.

The checksum (CRC) creation method is shown below.

```

/* CRC calculation */
/* Input   unsigned char length : Number of transmission bytes */
/*         unsigned char *top   : Transmission data start pointer */
/* Output  unsigned short CRC   : CRC calculation result      */
unsigned short crc16( unsigned char length, unsigned char *top )
{
    unsigned short CRC= 0xffff;
    unsigned short next;
    unsigned short carry;
    unsigned short n;
    unsigned char crcl;

    while ( length-- ) {
        next = (unsigned short)*top;
        CRC ^= next;
        for ( n = 0; n < 8; n++ ) {
            carry = CRC & 1;
            CRC >>= 1;
            if (carry) { CRC ^= 0xA001; }
        }
        top++;
    }

    crcl = (CRC & 0xff00)>>8;
    CRC <<= 8;
    CRC |= crcl;

    return CRC;
}

```

- 1-frame end judgment

A message end (1-frame end) is determined when a time period specified for each transmission speed has passed during which no character is received. It is considered that 1 frame has ended when the next character is not received before the time-out time shown below passes.

However, the time-out time has a fluctuation of ± 1 ms from the values in the table below.

Set transmission speed (bps)	Time-out time
4800	16ms or more
9600	8ms or more
19200	4ms or more
38400	2ms or more

■ Command type

There are two command (send message) types as shown below.

Command	Description	
	ASCII	RTU (binary)
Read command	"03" (sample)	03H (sample)
Write command	"10" (sample)	10H (sample)

■ Other specifications

- Supporting the Modbus Class 0
- Abnormal termination codes

Code	Description
01	Command error
02	Address error
03	Data error

- Maximum number of communication data words

Command	Number of data	
	ASCII	RTU
03 (READ)	16	16
10 (WRITE)	16	16

- The others

For the details of Modbus specifications,

 OPEN Modbus/TCP SPECIFICATION (Release 1.0) by Modicon Inc.

8 - 3 Description of Commands

■ Read command (03H)

● Send Message

This is a command capable of reading the contents of continuous data addresses from a specified read start data address with a single message. The following is an example of send message while reading data:

Modbus ASCII

3AH	30H	41H	30H	33H	30H	33H	45H	39H	30H	30H	30H	32H	30H	35H	0DH	0AH
:	0	A	0	3	0	3	E	9	0	0	0	2	0	5	CR	LF
(1)	(2)	(3)	(4)				(5)			(6)	(7)					

- (1) Start of message
- (2) Station address
- (3) Read command
- (4) Start data address
- (5) Number of read data
- (6) Checksum (LRC)
- (7) Delimiter

Modbus RTU

0AH	03H	03H	E9H	00H	02H	14H	C0H
(1)	(2)	(3)	(4)	(5)			

- (1) Station address
- (2) Read command
- (3) Start data address
- (4) Number of read data
- (5) Checksum (CRC)

● Response Message

A response message corresponding to the command content is returned when the message is correctly received.

The figure below shows the structure of the response message while reading data.

Modbus ASCII

• Example in case of normal reception

3AH	30H	41H	30H	33H	30H	34H	30H	33H	30H	31H	30H	30H	30H	33H	45H	38H	D0H	0AH
:	0	A	0	3	0	4	0	3	0	1	0	0	0	3	E	8	CR	LF
(1)	(2)	(3)	(4)	(5)				(6)			(7)	(8)						

- (1) Start of message
- (2) Station address
- (3) Read command
- (4) Number of read data X 2
- (5) Read data 1
- (6) Read data 2
- (7) Checksum (LRC)
- (8) Delimiter

• Example in case of error

3AH	30H	41H	38H	34H	30H	31H	37H	31H	0DH	0AH
:	0	A	8	4	0	1	7	1	CR	LF
(1)	(2)	(3)	(4)	(5)	(6)					

- (1) Start of message
- (2) Station address
- (3) Error flag (since undefined "04" is sent as a command with a send message, the most significant bit is turned ON and sent back as "84".)
- (4) Abnormal termination code (☞ page 8-6)
- (5) Checksum (LRC)
- (6) Delimiter

Modbus RTU

• Example in case of normal reception

0AH	03H	04H	03H	01H	00H	03H	51H	76H
(1)	(2)	(3)	(4)	(5)	(6)			

- (1) Station address
- (2) Read command
- (3) Number of read data X 2 (bytes)
- (4) Read data 1
- (5) Read data 2
- (6) Checksum (CRC)

• Example in case of error

0AH	84H	01H	F3H	02H
(1)	(2)	(3)	(4)	

- (1) Station address
- (2) Error flag (since undefined "04H" is sent as a command with a send message, the most significant bit is turned ON and sent back as "84H".)
- (3) Abnormal termination code (☞ page 8-6)
- (4) Checksum (CRC)

■ Write command (10H)

● Send Message

This is a command capable of writing the contents of continuous data addresses from a specified write start data address with a single message. The following is an example of send message while writing data:

(Example) Writing 01A0H and 0E53H in the continuous data addresses consisting of 2 words following 1501W (05DDH).

Modbus ASCII

3AH	30H	31H	31H	30H	30H	35H	44H	44H	30H	30H	30H	32H	30H	34H
:	0	1	1	0	0	5	D	D	0	0	0	2	0	4
(1)	(2)	(3)	(4)				(5)			(6)				

30H	31H	41H	30H	30H	45H	35H	33H	30H	35H	0DH	0AH	
0	1	A	0	0	E	5	3	0	5	CR	LF	
(7)				(8)			(9)		(10)			

- (1) Start of message
- (2) Station address
- (3) Write command 10H
- (4) Start data address
- (5) Number of write data
- (6) Number of write data X 2
- (7) Write data 1
- (8) Write data 2
- (9) Checksum
- (10) Delimiter

Modbus RTU

01H	10H	05H	DDH	00H	02H	04H	01H	A0H	0EH	53H	45H	B9H
(1)	(2)	(3)	(4)	(5)	(6)	(7)	(8)					

- (1) Station address
- (2) Write command 10H
- (3) Start data address
- (4) Number of write data
- (5) Number of write data x 2
- (6) Write data 1
- (7) Write data 2
- (8) Checksum

● **Response Message**

A response message corresponding to the command content is returned when the message is correctly received.

The figure below shows the structure of the response message when the data is written.

Modbus ASCII

3AH	30H	31H	31H	30H	30H	35H	44H	44H	30H	30H	30H	32H	30H	42H	0DH	0AH
:	0	1	1	0	0	5	D	D	0	0	0	2	0	B	CR	LF
(1)	(2)	(3)	(4)				(5)			(6)		(7)				

- (1) Start of message
- (2) Station address
- (3) Write command 10H
- (4) Start data address
- (5) Number of write data
- (6) Checksum
- (7) Delimiter

Modbus RTU

01H	10H	05H	DDH	00H	02H	D1H	3EH
(1)	(2)	(3)	(4)	(5)			

- (1) Station address
- (2) Write command 10H
- (3) Start data address
- (4) Number of write data
- (5) Checksum

 **Note**

The response message at the time of abnormal termination is the same as that for the read command.

8 - 4 Specifications Common with CPL Communication Function

■ Definition of data addresses

 7-4 Definition of Data Addresses (on page 7-13)

■ Numeric representation

The specifications of numeric representation is the same as the following:

 ● RD, WD, RU and WU commands in 7-5 Numeric Representation in the Application Layer (on page 7-14).

■ RS-485 driver control timing specifications

 7-7 Reception and Transmission Timing (on page 7-16).

Chapter 9. LIST OF COMMUNICATION DATA

■ List of communication data

The following shows the meanings of the symbols stated in the “RAM/EEPROM Read/Write” columns:

- No symbol: Possible.
- *: Possible according to the conditions.
- Δ: Possible, but data is invalid.
- X: Impossible.

Note: When reading the EEPROM address, data in the RAM is read in the same manner as reading of the RAM address.

- Decimal point information: No decimal point
- 1 to 3: Decimal point position (The communication data becomes that the original value is multiplied by 10, 100, or 1000.)
- P: Follows the PV input range.
- S: Follows various conditions.

RS/WS commands of CPL communication

Decimal data address with “W” attached next to it is used.

RD/WD/RU/WU commands of CPL communication: Hexadecimal data address is used.

Commands of Modbus communication: Hexadecimal data address is used.

Bank	Item name	RAM address		EEPROM address		RAM		EEPROM		Decimal point information	Notes
		Decimal	Hexadecimal	Decimal	Hexadecimal	Read	Write	Read	Write		
Instrument information	ROM ID	273	0111	16657	4111		X		X	—	"2" when using SDC35/36.
	ROM Version 1	274	0112	16658	4112		X		X	2	
	ROM Version 2	275	0113	16659	4113		X		X	2	
	LOADER Information	276	0114	16660	4114		X		X	—	
	EST Information	277	0115	16661	4115		X		X	—	
	Manufacturing date code (year)	278	0116	16662	4116		X		X	—	Year - 2000 Example: Year of 2003 is expressed as "3"
	Manufacturing date code (month, day)	279	0117	16663	4117		X		X	2	Month + (Day ÷ 100) Example: Dec. 1st is expressed as "12.01".
	Serial No.	280	0118	16664	4118		X		X	—	
Lock	Key lock	5001	1389	21385	5389					—	
	Communication lock	5002	138A	21386	538A	*	X	*	X	—	When the communication lock exists, the error response is sent.
	Loader lock	5003	138B	21387	538B		X		X	—	
	Password display	5004	138C	21388	538C				X	—	
	Password 1A	—	—	—	—	X	X	X	X	—	Communication and loader cannot read and write the password.
	Password 2A	—	—	—	—	X	X	X	X	—	Same as above.
	Password 1B	—	—	—	—	X	X	X	X	—	Same as above.
	Password 2B	—	—	—	—	X	X	X	X	—	Same as above.
User Function	User Function 1	5101	13ED	21485	53ED					—	
	User Function 2	5102	13EE	21486	53EE					—	
	User Function 3	5103	13EF	21487	53EF					—	
	User Function 4	5104	13F0	21488	53F0					—	
	User Function 5	5105	13F1	21489	53F1					—	
	User Function 6	5106	13F2	21490	53F2					—	
	User Function 7	5107	13F3	21491	53F3					—	
	User Function 8	5108	13F4	21492	53F4					—	
Setup	PV input range type	5201	1451	21585	5451					—	
	Temperature unit	5202	1452	21586	5452		*		*	—	
	Cold junction compensation (T/C)	5203	1453	21587	5453		*		*	—	
	Decimal point position	5204	1454	21588	5454		*		*	—	

(Continue on next page.)

Chapter 9. LIST OF COMMUNICATION DATA

Bank	Item name	RAM address		EEPROM address		RAM		EEPROM		Decimal point information	Notes
		Decimal	Hexadecimal	Decimal	Hexadecimal	Read	Write	Read	Write		
Setup	PV input range low limit	5205	1455	21589	5455		*		*	P	
	PV input range high limit	5206	1456	21590	5456		*		*	P	
	SP low limit	5207	1457	21591	5457					P	
	SP high limit	5208	1458	21592	5458					P	
	PV square root extraction dropout	5209	1459	21593	5459		*		*	1	
	RSP input type	5210	145A	21594	545A		*		*	—	
	RSP input range low limit	5211	145B	21595	545B		*		*	P	
	RSP input range high limit	5212	145C	21596	545C		*		*	P	
	PID calculation adjustment function	5213	145D	21597	545D					—	(Note 1)
	Control action (Direct/Reverse)	5214	145E	21598	545E					—	
	Output operation at PV alarm	5215	145F	21599	545F					—	
	Output at PV alarm	5216	1460	21600	5460					1	
	Output at READY (Heat)	5217	1461	21601	5461					1	
	Output at READY (Cool)	5218	1462	21602	5462					1	
	Output operation at changing Auto/Manual	5219	1463	21603	5463					—	
	Preset MANUAL value	5220	1464	21604	5464					1	
	Initial output type (mode) of PID control	5221	1465	21605	5465					—	
	Initial output of PID control	5222	1466	21606	5466					1	
	PID decimal point position	5223	1467	21607	5467					—	
	Zone PID operation	5224	1468	21608	5468					—	
	(Reserved for future extension.)	5225	1469	21609	5469	Δ	X	Δ	X	—	
	Heat/Cool control	5226	146A	21610	546A					—	
	Heat/Cool selection	5227	146B	21611	546B					—	
	Heat/Cool control deadband	5228	146C	21612	546C					1	
	Heat/Cool control change point	5229	146D	21613	546D					1	
	LSP system group	5230	146E	21614	546E					—	
	SP ramp type	5231	146F	21615	546F					—	
	SP ramp unit	5232	1470	21616	5470					—	
	STEP time unit	5233	1471	21617	5471					—	
	STEP PV start	5234	1472	21618	5472					—	
	STEP loop	5235	1473	21619	5473					—	
	CT1 operation type	5236	1474	21620	5474					—	
	CT1 output	5237	1475	21621	5475					—	
	CT1 measurement wait time	5238	1476	21622	5476					—	
	CT2 operation type	5239	1477	21623	5477					—	
	CT2 output	5240	1478	21624	5478					—	
	CT2 measurement wait time	5241	1479	21625	5479					—	
	Control output 1 range	5242	147A	21626	547A					—	
	Control output 1 type	5243	147B	21627	547B					—	
	Control output 1 scaling low limit	5244	147C	21628	547C					S	
	Control output 1 scaling high limit	5245	147D	21629	547D					S	
	Control output 1 MV scaling	5246	147E	21630	547E					P	(Note 2)
Control output 2 range	5247	147F	21631	547F					—		
Control output 2 type	5248	1480	21632	5480					—		
Control output 2 scaling low limit	5249	1481	21633	5481					S		
Control output 2 scaling high limit	5250	1482	21634	5482					S		
Control output 2 MV scaling	5251	1483	21635	5483					P	(Note 2)	
AUX output range	5252	1484	21636	5484					—		
AUX output type	5253	1485	21637	5485					—		

(Continue on next page.)

Bank	Item name	RAM address		EEPROM address		RAM		EEPROM		Decimal point information	Notes
		Decimal	Hexadecimal	Decimal	Hexadecimal	Read	Write	Read	Write		
Setup	AUX output scaling low limit	5254	1486	21638	5486					S	
	AUX output scaling high limit	5255	1487	21639	5487					S	
	AUX output MV scaling	5256	1488	21640	5488					P	(Note 2)
	Position proportional type	5257	1489	21641	5489		*		*	—	
	Position proportional deadband	5258	148A	21642	548A		*		*	1	
	Motor long life mode	5259	148B	21643	548B		*		*	—	
	Motor auto adjust	5260	148C	21644	548C		*		*	—	
	Input with motor fully closed	5261	148D	21645	548D		*		*	—	
	Input with motor fully open	5262	148E	21646	548E		*		*	—	
	Motor full close-full open time	5263	148F	21647	548F		*		*	1	
	CPL/Modbus	5264	1490	21648	5490		X		X	—	
	Station address	5265	1491	21649	5491		X		X	—	
	Transmission speed	5266	1492	21650	5492		X		X	—	
	Data format (Data length)	5267	1493	21651	5493		X		X	—	
	Data format (Parity)	5268	1494	21652	5494		X		X	—	
	Data format (Stop bit)	5269	1495	21653	5495		X		X	—	
	Response time-out	5270	1496	21654	5496		X		X	—	
	Key operation type	5271	1497	21655	5497					—	
	[mode] key function	5272	1498	21656	5498					—	
	MODE display setup	5273	1499	21657	5499					—	
	PV/SP display setup	5274	149A	21658	549A					—	
	MV display setup	5275	149B	21659	549B					—	
	EV display setup	5276	149C	21660	549C					—	
	Timer remaining time display setup	5277	149D	21661	549D					—	
	CT display setup	5278	149E	21662	549E					—	
	User level	5279	149F	21663	549F					—	
	Communication monitoring display	5280	14A0	21664	54A0					—	
	Multi Status (MS) display, Condition (top priority)	5281	14A1	21665	54A1					—	
	Multi Status (MS) display, Status (top priority)	5282	14A2	21666	54A2					—	
	Multi Status (MS) display, Condition (second priority)	5283	14A3	21667	54A3					—	
	Multi Status (MS) display, Status (second priority)	5284	14A4	21668	54A4					—	
	Multi Status (MS) display, Condition (third priority)	5285	14A5	21669	54A5					—	
	Multi Status (MS) display, Status (third priority)	5286	14A6	21670	54A6					—	
Multi Status (MS) display, deviation range	5287	14A7	21671	54A7					—		
Special function	5288	14A8	21672	54A8				X	—		
Zener barrier adjustment	5289	14A9	21673	54A9		X		X	—		
CT1 turns	5290	14AA	21674	54AA					—	(Note 2)	
Number of CT1 power wire loops	5291	14AB	21675	54AB					—	(Note 2)	
CT2 turns	5292	14AC	21676	54AC					—	(Note 2)	
Number of CT2 power wire loops	5293	14AD	21677	54AD					—	(Note 2)	
PV input failure (under range) type	5297	14B1	21681	54B1					—	(Note 1)	
DI Assignment	Internal Contact 1 Operation type	5401	1519	21785	5519					—	
	Internal Contact 1 Input bit function	5402	151A	21786	551A					—	
	Internal Contact 1 Input assignment A	5403	151B	21787	551B					—	
	Internal Contact 1 Input assignment B	5404	151C	21788	551C					—	
	Internal Contact 1 Input assignment C	5405	151D	21789	551D					—	
	Internal Contact 1 Input assignment D	5406	151E	21790	551E					—	

(Continue on next page.)

(Note 1) If ROM version 1 in the instrument information bank (1002) is 2.26 or earlier, write accessibility is X and read accessibility is Δ.

(Note 2) If ROM version 1 in the instrument information bank (1002) is 2.04 or earlier, this item is reserved for future extension, write accessibility is X and read accessibility is Δ for both RAM and EEPROM.

Chapter 9. LIST OF COMMUNICATION DATA

Bank	Item name	RAM address		EEPROM address		RAM		EEPROM		Decimal point information	Notes
		Decimal	Hexadecimal	Decimal	Hexadecimal	Read	Write	Read	Write		
DI Assignment	Internal Contact 1 Polarity A	5407	151F	21791	551F					—	
	Internal Contact 1 Polarity B	5408	1520	21792	5520					—	
	Internal Contact 1 Polarity C	5409	1521	21793	5521					—	
	Internal Contact 1 Polarity D	5410	1522	21794	5522					—	
	Internal Contact 1 Polarity	5411	1523	21795	5523					—	
	Internal Contact 1 Event channel definition	5412	1524	21796	5524					—	
	Internal Contact 2 Operation type	5413	1525	21797	5525					—	
	Internal Contact 2 Input bit function	5414	1526	21798	5526					—	
	Internal Contact 2 Input assignment A	5415	1527	21799	5527					—	
	Internal Contact 2 Input assignment B	5416	1528	21800	5528					—	
	Internal Contact 2 Input assignment C	5417	1529	21801	5529					—	
	Internal Contact 2 Input assignment D	5418	152A	21802	552A					—	
	Internal Contact 2 Polarity A	5419	152B	21803	552B					—	
	Internal Contact 2 Polarity B	5420	152C	21804	552C					—	
	Internal Contact 2 Polarity C	5421	152D	21805	552D					—	
	Internal Contact 2 Polarity D	5422	152E	21806	552E					—	
	Internal Contact 2 Polarity	5423	152F	21807	552F					—	
	Internal Contact 2 Event channel definition	5424	1530	21808	5530					—	
	Internal Contact 3 Operation type	5425	1531	21809	5531					—	
	Internal Contact 3 Input bit function	5426	1532	21810	5532					—	
	Internal Contact 3 Input assignment A	5427	1533	21811	5533					—	
	Internal Contact 3 Input assignment B	5428	1534	21812	5534					—	
	Internal Contact 3 Input assignment C	5429	1535	21813	5535					—	
	Internal Contact 3 Input assignment D	5430	1536	21814	5536					—	
	Internal Contact 3 Polarity A	5431	1537	21815	5537					—	
	Internal Contact 3 Polarity B	5432	1538	21816	5538					—	
	Internal Contact 3 Polarity C	5433	1539	21817	5539					—	
	Internal Contact 3 Polarity D	5434	153A	21818	553A					—	
	Internal Contact 3 Polarity	5435	153B	21819	553B					—	
	Internal Contact 3 Event channel definition	5436	153C	21820	553C					—	
	Internal Contact 4 Operation type	5437	153D	21821	553D					—	
	Internal Contact 4 Input bit function	5438	153E	2182	553E					—	
	Internal Contact 4 Input assignment A	5439	153F	2182	553F					—	
	Internal Contact 4 Input assignment B	5440	1540	21824	5540					—	
	Internal Contact 4 Input assignment C	5441	1541	21825	5541					—	
	Internal Contact 4 Input assignment D	5442	1542	21826	5542					—	
	Internal Contact 4 Polarity A	5443	1543	21827	5543					—	
	Internal Contact 4 Polarity B	5444	1544	21828	5544					—	
	Internal Contact 4 Polarity C	5445	1545	21829	5545					—	
	Internal Contact 4 Polarity D	5446	1546	21830	5546					—	
	Internal Contact 4 Polarity	5447	1547	21831	5547					—	
	Internal Contact 4 Event channel definition	5448	1548	21832	5548					—	
	Internal Contact 5 Operation type	5449	1549	21833	5549					—	
	Internal Contact 5 Input bit function	5450	154A	21834	554A					—	
	Internal Contact 5 Input assignment A	5451	154B	21835	554B					—	
	Internal Contact 5 Input assignment B	5452	154C	21836	554C					—	
	Internal Contact 5 Input assignment C	5453	154D	21837	554D					—	
	Internal Contact 5 Input assignment D	5454	154E	21838	554E					—	

(Continue on next page.)

Bank	Item name	RAM address		EEPROM address		RAM		EEPROM		Decimal point information	Notes
		Decimal	Hexadecimal	Decimal	Hexadecimal	Read	Write	Read	Write		
DI Assignment	Internal Contact 5 Polarity A	5455	154F	21839	554F					—	
	Internal Contact 5 Polarity B	5456	1550	21840	5550					—	
	Internal Contact 5 Polarity C	5457	1551	21841	5551					—	
	Internal Contact 5 Polarity	5458	1552	21842	5552					—	
	Internal Contact 5 Polarity	5459	1553	21843	5553					—	
	Internal Contact 5 Event channel definition	5460	1554	21844	5554					—	
DO Assignment	Control output 1 Operation type	5601	15E1	21985	55E1					—	
	Control output 1 Output assignment A	5602	15E2	21986	55E2					—	
	Control output 1 Output assignment B	5603	15E3	21987	55E3					—	
	Control output 1 Output assignment C	5604	15E4	21988	55E4					—	
	Control output 1 Output assignment D	5605	15E5	21989	55E5					—	
	Control output 1 Polarity A	5606	15E6	21990	55E6					—	
	Control output 1 Polarity B	5607	15E7	21991	55E7					—	
	Control output 1 Polarity C	5608	15E8	21992	55E8					—	
	Control output 1 Polarity D	5609	15E9	21993	55E9					—	
	Control output 1 Polarity	5610	15EA	21994	55EA					—	
	Control output 1 Latch	5611	15EB	21995	55EB					—	
	Control output 2 Operation type	5612	15EC	21996	55EC					—	
	Control output 2 Output assignment A	5613	15ED	21997	55ED					—	
	Control output 2 Output assignment B	5614	15EE	21998	55EE					—	
	Control output 2 Output assignment C	5615	15EF	21999	55EF					—	
	Control output 2 Output assignment D	5616	15F0	22000	55F0					—	
	Control output 2 Polarity A	5617	15F1	22001	55F1					—	
	Control output 2 Polarity B	5618	15F2	22002	55F2					—	
	Control output 2 Polarity C	5619	15F3	22003	55F3					—	
	Control output 2 Polarity D	5620	15F4	22004	55F4					—	
	Control output 2 Polarity	5621	15F5	22005	55F5					—	
	Control output 2 Latch	5622	15F6	22006	55F6					—	
	Event output 1 Operation type	5623	15F7	22007	55F7					—	
	Event output 1 Output assignment A	5624	15F8	22008	55F8					—	
	Event output 1 Output assignment B	5625	15F9	22009	55F9					—	
	Event output 1 Output assignment C	5626	15FA	22010	55FA					—	
	Event output 1 Output assignment D	5627	15FB	22011	55FB					—	
	Event output 1 Polarity A	5628	15FC	22012	55FC					—	
	Event output 1 Polarity B	5629	15FD	22013	55FD					—	
	Event output 1 Polarity C	5630	15FE	22014	55FE					—	
	Event output 1 Polarity D	5631	15FF	22015	55FF					—	
	Event output 1 Polarity	5632	1600	22016	5600					—	
	Event output 1 Latch	5633	1601	22017	5601					—	
	Event output 2 Operation type	5634	1602	22018	5602					—	
	Event output 2 Output assignment A	5635	1603	22019	5603					—	
	Event output 2 Output assignment B	5636	1604	22020	5604					—	
	Event output 2 Output assignment C	5637	1605	22021	5605					—	
	Event output 2 Output assignment D	5638	1606	22022	5606					—	
	Event output 2 Polarity A	5639	1607	22023	5607					—	
	Event output 2 Polarity B	5640	1608	22024	5608					—	
	Event output 2 Polarity C	5641	1609	22025	5609					—	
	Event output 2 Polarity D	5642	160A	22026	560A					—	
	Event output 2 Polarity	5643	160B	22027	560B					—	
	Event output 2 Latch	5644	160C	22028	560C					—	

(Continue on next page.)

Chapter 9. LIST OF COMMUNICATION DATA

Bank	Item name	RAM address		EEPROM address		RAM		EEPROM		Decimal point information	Notes
		Decimal	Hexadecimal	Decimal	Hexadecimal	Read	Write	Read	Write		
DO Assignment	Event output 3 Operation type	5645	160D	22029	560D					—	
	Event output 3 Output assignment A	5646	160E	22030	560E					—	
	Event output 3 Output assignment B	5647	160F	22031	560F					—	
	Event output 3 Output assignment C	5648	1610	22032	5610					—	
	Event output 3 Output assignment D	5649	1611	22033	5611					—	
	Event output 3 Polarity A	5650	1612	22034	5612					—	
	Event output 3 Polarity B	5651	1613	22035	5613					—	
	Event output 3 Polarity C	5652	1614	22036	5614					—	
	Event output 3 Polarity D	5653	1615	22037	5615					—	
	Event output 3 Polarity	5654	1616	22038	5616					—	
	Event output 3 Latch	5655	1617	22039	5617					—	
Event Configuration	Internal Event 1 Operation type	5801	16A9	22185	56A9					—	
	Internal Event 1 Direct/Reverse	5802	16AA	22186	56AA					—	
	Internal Event 1 Standby	5803	16AB	22187	56AB					—	
	Internal Event 1 state at READY	5804	16AC	22188	56AC					—	
	(Reserved for future extension.)	5805	16AD	22189	56AD	Δ	Δ	Δ	Δ	—	
	Internal Event 1 Alarm OR	5806	16AE	22190	56AE					—	
	Internal Event 1 Special OFF	5807	16AF	22191	56AF					—	
	Internal Event 1 Delay time unit	5808	16B0	22192	56B0					—	
	(Reserved for future extension.)	5809	16B1	22193	56B1	Δ	Δ	Δ	Δ	—	
	Internal Event 2 Operation type	5810	16B2	22194	56B2					—	
	Internal Event 2 Direct/Reverse	5811	16B3	22195	56B3					—	
	Internal Event 2 Standby	5812	16B4	22196	56B4					—	
	Internal Event 2 state at READY	5813	16B5	22197	56B5					—	
	(Reserved for future extension.)	5814	16B6	22198	56B6	Δ	Δ	Δ	Δ	—	
	Internal Event 2 Alarm OR	5815	16B7	22199	56B7					—	
	Internal Event 2 Special OFF	5816	16B8	22200	56B8					—	
	Internal Event 2 Delay time unit	5817	16B9	22201	56B9					—	
	(Reserved for future extension.)	5818	16BA	22202	56BA	Δ	Δ	Δ	Δ	—	
	Internal Event 3 Operation type	5819	16BB	22203	56BB					—	
	Internal Event 3 Direct/Reverse	5820	16BC	22204	56BC					—	
	Internal Event 3 Standby	5821	16BD	22205	56BD					—	
	Internal Event 3 state at READY	5822	16BE	22206	56BE					—	
	(Reserved for future extension.)	5823	16BF	22207	56BF	Δ	Δ	Δ	Δ	—	
	Internal Event 3 Alarm OR	5824	16C0	22208	56C0					—	
	Internal Event 3 Special OFF	5825	16C1	22209	56C1					—	
	Internal Event 3 Delay time unit	5826	16C2	22210	56C2					—	
	(Reserved for future extension.)	5827	16C3	22211	56C3	Δ	Δ	Δ	Δ	—	
	Internal Event 4 Operation type	5828	16C4	22212	56C4					—	
	Internal Event 4 Direct/Reverse	5829	16C5	22213	56C5					—	
	Internal Event 4 Standby	5830	16C6	22214	56C6					—	
	Internal Event 4 state at READY	5831	16C7	22215	56C7					—	
	(Reserved for future extension.)	5832	16C8	22216	56C8	Δ	Δ	Δ	Δ	—	
	Internal Event 4 Alarm OR	5833	16C9	22217	56C9					—	
	Internal Event 4 Special OFF	5834	16CA	22218	56CA					—	
	Internal Event 4 Delay time unit	5835	16CB	22219	56CB					—	
	(Reserved for future extension.)	5836	16CC	22220	56CC	Δ	Δ	Δ	Δ	—	
	Internal Event 5 Operation type	5837	16CD	22221	56CD					—	
	Internal Event 5 Direct/Reverse	5838	16CE	22222	56CE					—	
	Internal Event 5 Standby	5839	16CF	22223	56CF					—	

(Continue on next page.)

Bank	Item name	RAM address		EEPROM address		RAM		EEPROM		Decimal point information	Notes
		Decimal	Hexadecimal	Decimal	Hexadecimal	Read	Write	Read	Write		
Event Configuration	Internal Event 5 state at READY	5840	16D0	22224	56D0					—	
	(Reserved for future extension.)	5841	16D1	22225	56D1	Δ	Δ	Δ	Δ	—	
	Internal Event 5 Alarm OR	5842	16D2	22226	56D2					—	
	Internal Event 5 Special OFF	5843	16D3	22227	56D3					—	
	Internal Event 5 Delay time unit	5844	16D4	22228	56D4					—	
	(Reserved for future extension.)	5845	16D5	22229	56D5	Δ	Δ	Δ	Δ	—	
	Internal Event 6 Operation type	5846	16D6	22230	56D6					—	
	Internal Event 6 Direct/Reverse	5847	16D7	22231	56D7					—	
	Internal Event 6 Standby	5848	16D8	22232	56D8					—	
	Internal Event 6 state at READY	5849	16D9	22233	56D9					—	
	(Reserved for future extension.)	5850	16DA	22234	56DA	Δ	Δ	Δ	Δ	—	
	Internal Event 6 Alarm OR	5851	16DB	22235	56DB					—	
	Internal Event 6 Special OFF	5852	16DC	22236	56DC					—	
	Internal Event 6 Delay time unit	5853	16DD	22237	56DD					—	
	(Reserved for future extension.)	5854	16DE	22238	56DE	Δ	Δ	Δ	Δ	—	
	Internal Event 7 Operation type	5855	16DF	22239	56DF					—	
	Internal Event 7 Direct/Reverse	5856	16E0	22240	56E0					—	
	Internal Event 7 Standby	5857	16E1	22241	56E1					—	
	Internal Event 7 state at READY	5858	16E2	22242	56E2					—	
	(Reserved for future extension.)	5859	16E3	22243	56E3	Δ	Δ	Δ	Δ	—	
	Internal Event 7 Alarm OR	5860	16E4	22244	56E4					—	
	Internal Event 7 Special OFF	5861	16E5	22245	56E5					—	
	Internal Event 7 Delay time unit	5862	16E6	22246	56E6					—	
	(Reserved for future extension.)	5863	16E7	22247	56E7	Δ	Δ	Δ	Δ	—	
	Internal Event 8 Operation type	5864	16E8	22248	56E8					—	
	Internal Event 8 Direct/Reverse	5865	16E9	22249	56E9					—	
	Internal Event 8 Standby	5866	16EA	22250	56EA					—	
	Internal Event 8 state at READY	5867	16EB	22251	56EB					—	
	(Reserved for future extension.)	5868	16EC	22252	56EC	Δ	Δ	Δ	Δ	—	
	Internal Event 8 Alarm OR	5869	16ED	22253	56ED					—	
	Internal Event 8 Special OFF	5870	16EE	22254	56EE					—	
	Internal Event 8 Delay time unit	5871	16EF	22255	56EF					—	
(Reserved for future extension.)	5872	16F0	22256	56F0	Δ	Δ	Δ	Δ	—		
Parameter	Control method	6001	1771	22385	5771					—	
	MV low limit at AT	6002	1772	22386	5772					1	
	MV high limit at AT	6003	1773	22387	5773					1	
	Differential (for ON/OFF control)	6004	1774	22388	5774					P	
	ON/OFF control action point offset	6005	1775	22389	5775					P	
	PV filter	6006	1776	22390	5776					1	
	PV ratio	6007	1777	22391	5777					3	
	PV bias	6008	1778	22392	5778					P	
	RSP filter	6009	1779	22393	5779					1	
	RSP ratio	6010	177A	22394	577A					3	
	RSP bias	6011	177B	22395	577B					P	
	Time proportional unit 1	6012	177C	22396	577C					—	
	Time proportional cycle 1	6013	177D	22397	577D					—	
	Time proportional unit 2	6014	177E	22398	577E					—	
	Time proportional cycle 2	6015	177F	22399	577F					—	
	Time proportional cycle mode	6016	1780	22400	5780					—	
	Output variation limit	6017	1781	22401	5781					1	

(Continue on next page.)

Chapter 9. LIST OF COMMUNICATION DATA

Bank	Item name	RAM address		EEPROM address		RAM		EEPROM		Decimal point information	Notes
		Decimal	Hexadecimal	Decimal	Hexadecimal	Read	Write	Read	Write		
Parameter	SP ramp-up	6018	1782	22402	5782					S	
	SP ramp-down	6019	1783	22403	5783					S	
	(Reserved for future extension.)	6020	1784	22404	5784	Δ	Δ	Δ	Δ	P	
Zone	Zone 1	6201	1839	22585	5839					P	
	Zone 2	6202	183A	22586	583A					P	
	Zone 3	6203	183B	22587	583B					P	
	Zone 4	6204	183C	22588	583C					P	
	Zone 5	6205	183D	22589	583D					P	
	Zone 6	6206	183E	22590	583E					P	
	Zone 7	6207	183F	22591	583F					P	
	Zone hysteresis	6208	1840	22592	5840					P	
SP	RSP	7001	1B59	23385	5B59		X		X	P	
	PID group number for RSP	7002	1B5A	23386	5B5A					—	
	(Reserved for future extension.)	7003	1B5B	23387	5B5B	Δ	Δ	Δ	Δ	S	
	(Reserved for future extension.)	7004	1B5C	23388	5B5C	Δ	Δ	Δ	Δ	S	
	LSP1	7005	1B5D	23389	5B5D					P	Same as RAM address 13312 (decimal).
	PID group number for LSP1	7006	1B5E	23390	5B5E					—	
	Ramp for LSP1	7007	1B5F	23391	5B5F					S	
	Time for LSP1	7008	1B60	23392	5B60					S	
	LSP2	7009	1B61	23393	5B61					P	Same as RAM address 13313 (decimal).
	PID group number for LSP2	7010	1B62	23394	5B62					—	
	Ramp for LSP2	7011	1B63	23395	5B63					S	
	Time for LSP2	7012	1B64	23396	5B64					S	
	LSP3	7013	1B65	23397	5B65					P	Same as RAM address 13314 (decimal).
	PID group number for LSP3	7014	1B66	23398	5B66					—	
	Ramp for LSP3	7015	1B67	23399	5B67					S	
	Time for LSP3	7016	1B68	23400	5B68					S	
	LSP4	7017	1B69	23401	5B69					P	Same as RAM address 13315 (decimal).
	PID group number for LSP4	7018	1B6A	23402	5B6A					—	
	Ramp for LSP4	7019	1B6B	23403	5B6B					S	
	Time for LSP4	7020	1B6C	23404	5B6C					S	
	LSP5	7021	1B6D	23405	5B6D					P	Same as RAM address 13316 (decimal).
	PID group number for LSP5	7022	1B6E	23406	5B6E					—	
	Ramp for LSP5	7023	1B6F	23407	5B6F					S	
	Time for LSP5	7024	1B70	23408	5B70					S	
	LSP6	7025	1B71	23409	5B71					P	Same as RAM address 13317 (decimal).
	PID group number for LSP6	7026	1B72	23410	5B72					—	
	Ramp for LSP6	7027	1B73	23411	5B73					S	
	Time for LSP6	7028	1B74	23412	5B74					S	
	LSP7	7029	1B75	23413	5B75					P	Same as RAM address 13318 (decimal).
	PID group number for LSP7	7030	1B76	23414	5B76					—	
	Ramp for LSP7	7031	1B77	23415	5B77					S	
	Time for LSP7	7032	1B78	23416	5B78					S	

(Continue on next page.)

Bank	Item name	RAM address		EEPROM address		RAM		EEPROM		Decimal point information	Notes
		Decimal	Hexadecimal	Decimal	Hexadecimal	Read	Write	Read	Write		
SP	LSP8	7033	1B79	23417	5B79					P	Same as RAM address 13319 (decimal).
	PID group number for LSP8	7034	1B7A	23418	5B7A					—	
	Ramp for LSP8	7035	1B7B	23419	5B7B					S	
	Time for LSP8	7036	1B7C	23420	5B7C					S	
Event	Internal Event 1 main setting	7501	1D4D	23885	5D4D					S	Same as RAM address 13056 (decimal).
	Internal Event 1 sub-setting	7502	1D4E	23886	5D4E					S	Same as RAM address 13057 (decimal).
	Internal Event 1 Hysteresis	7503	1D4F	23887	5D4F					S	
	Internal Event 1 ON delay time	7504	1D50	23888	5D50					S	
	Internal Event 1 OFF delay time	7505	1D51	23889	5D51					S	
	Internal Event 2 main setting	7506	1D52	23890	5D52					S	Same as RAM address 13058 (decimal).
	Internal Event 2 sub-setting	7507	1D53	23891	5D53					S	Same as RAM address 13059 (decimal).
	Internal Event 2 Hysteresis	7508	1D54	23892	5D54					S	
	Internal Event 2 ON delay time	7509	1D55	23893	5D55					S	
	Internal Event 2 OFF delay time	7510	1D56	23894	5D56					S	
	Internal Event 3 main setting	7511	1D57	23895	5D57					S	Same as RAM address 13060 (decimal).
	Internal Event 3 sub-setting	7512	1D58	23896	5D58					S	Same as RAM address 13061 (decimal).
	Internal Event 3 Hysteresis	7513	1D59	23897	5D59					S	
	Internal Event 3 ON delay time	7514	1D5A	23898	5D5A					S	
	Internal Event 3 OFF delay time	7515	1D5B	23899	5D5B					S	
	Internal Event 4 main setting	7516	1D5C	23900	5D5C					S	Same as RAM address 13062 (decimal).
	Internal Event 4 sub-setting	7517	1D5D	23901	5D5D					S	Same as RAM address 13063 (decimal).
	Internal Event 4 Hysteresis	7518	1D5E	23902	5D5E					S	
	Internal Event 4 ON delay time	7519	1D5F	23903	5D5F					S	
	Internal Event 4 OFF delay time	7520	1D60	23904	5D60					S	
	Internal Event 5 main setting	7521	1D61	23905	5D61					S	Same as RAM address 13064 (decimal).
	Internal Event 5 sub-setting	7522	1D62	23906	5D62					S	Same as RAM address 13065 (decimal).
	Internal Event 5 Hysteresis	7523	1D63	23907	5D63					S	
	Internal Event 5 ON delay time	7524	1D64	23908	5D64					S	
	Internal Event 5 OFF delay time	7525	1D65	23909	5D65					S	
	Internal Event 6 main setting	7526	1D66	23910	5D66					S	Same as RAM address 13066 (decimal).
	Internal Event 6 sub-setting	7527	1D67	23911	5D67					S	Same as RAM address 13067 (decimal).
	Internal Event 6 Hysteresis	7528	1D68	23912	5D68					S	
Internal Event 6 ON delay time	7529	1D69	23913	5D69					S		
Internal Event 6 OFF delay time	7530	1D6A	23914	5D6A					S		
Internal Event 7 main setting	7531	1D6B	23915	5D6B					S	Same as RAM address 13068 (decimal).	
Internal Event 7 sub-setting	7532	1D6C	23916	5D6C					S	Same as RAM address 13069 (decimal).	
Internal Event 7 Hysteresis	7533	1D6D	23917	5D6D					S		

(Continue on next page.)

Chapter 9. LIST OF COMMUNICATION DATA

Bank	Item name	RAM address		EEPROM address		RAM		EEPROM		Decimal point information	Notes
		Decimal	Hexadecimal	Decimal	Hexadecimal	Read	Write	Read	Write		
Event	Internal Event 7 ON delay time	7534	1D6E	23918	5D6E					S	
	Internal Event 7 OFF delay time	7535	1D6F	23919	5D6F					S	
	Internal Event 8 main setting	7536	1D70	23920	5D70					S	Same as RAM address 13070 (decimal).
	Internal Event 8 sub-setting	7537	1D71	23921	5D71					S	Same as RAM address 13071 (decimal).
	Internal Event 8 Hysteresis	7538	1D72	23922	5D72					S	
	Internal Event 8 ON delay time	7539	1D73	23923	5D73					S	
	Internal Event 8 OFF delay time	7540	1D74	23924	5D74					S	
Extended tuning	AT type	8501	2135	24885	6135					—	
	(Reserved for future extension.)	8502	2136	24886	6136	Δ	X	Δ	X	—	
	Just-FITTER settling band	8503	2137	24887	6137					—	
	SP lag constant	8504	2138	24888	6138					1	
	(Reserved for future extension.)	8505	2139	24889	6139	Δ	X	Δ	X	—	
	AT Proportional band adjust	8506	213A	24890	613A					2	
	AT Integral time adjust	8507	213B	24891	613B					2	
	AT Derivative time adjust	8508	213C	24892	613C					2	
	Control algorithm	8509	213D	24893	613D					—	
	Just-FITTER overshoot limit/restraint/control coefficient	8510	213E	24894	613E					—	
	(Reserved for future extension.)	8511	213F	24895	613F	Δ	X	Δ	X	—	
	(Reserved for future extension.)	8512	2140	24896	6140	Δ	X	Δ	X	—	
	(Reserved for future extension.)	8513	2141	24897	6141	Δ	X	Δ	X	—	
	(Reserved for future extension.)	8514	2142	24898	6142	Δ	X	Δ	X	—	
	(Reserved for future extension.)	8515	2143	24899	6143	Δ	Δ	Δ	Δ	2	
	(Reserved for future extension.)	8516	2144	24900	6144	Δ	Δ	Δ	Δ	2	
(Reserved for future extension.)	8517	2145	24901	6145	Δ	Δ	Δ	Δ	2		
(Reserved for future extension.)	8518	2146	24902	6146	Δ	Δ	Δ	Δ	—		
Mode	AUTO/MANUAL	9001	2329	25385	6329		*		*	—	Same as RAM address 14596 (decimal). Writing is enabled under no DI Assignment and other conditions.
	RUN/READY	9002	232A	25386	632A		*		*	—	Same as RAM address 14595 (decimal). Writing is enabled under no DI Assignment conditions.
	LSP/RSP	9003	232B	25387	632B		*		*	—	Same as RAM address 14598 (decimal). Writing is enabled under no DI Assignment conditions.
	AT stop/start	9004	232C	25388	632C		*		*	—	Same as RAM address 14597 (decimal). Writing is enabled under no DI Assignment and other conditions.
	Release all DO latches	9005	232D	25389	632D		*		*	—	Writing is enabled under no DI Assignment conditions.
Operation display	PV	9101	238D	25485	638D		X		X	P	Same as RAM address 14356 (decimal).
	SP (Target value)	9102	238E	25486	638E					P	(Note 3)
	LSP group selection	9103	238F	25487	638F		*		*	—	Same as RAM address 14592 (decimal). Writing is enabled under no DI Assignment conditions. (Note 4)
	PID group being selected.	9104	2390	25488	6390		X		X	—	

(Continue on next page.)

Bank	Item name	RAM address		EEPROM address		RAM		EEPROM		Decimal point information	Notes
		Decimal	Hexadecimal	Decimal	Hexadecimal	Read	Write	Read	Write		
Operation display	Manipulated Variable (MV)	9105	2391	25489	6391		*		*	1	Same as RAM address 14594 (decimal). Writing is enabled in the MANUAL mode.
	Heat Manipulated Variable (Heat MV)	9106	2392	25490	6392		X		X	1	Same as RAM address 14420 (decimal).
	Cool Manipulated Variable (Cool MV)	9107	2393	25491	6393		X		X	1	Same as RAM address 14421 (decimal).
	Motor opening feedback value (MFB)	9108	2394	25492	6394		X		X	1	Same as RAM address 14417 (decimal).
	AT progress	9109	2395	25493	6395		X		X	—	
	Current transformer (CT) current value 1	9110	2396	25494	6396		X		X	1	Same as RAM address 14418 (decimal).
	Current transformer (CT) current value 2	9111	2397	25495	6397		X		X	1	Same as RAM address 14419 (decimal).
	Timer remaining time 1	9112	2398	25496	6398		X		X	S	
	Timer remaining time 2	9113	2399	25497	6399		X		X	S	
	Timer remaining time 3	9114	239A	25498	639A		X		X	S	
	Timer remaining time 4	9115	239B	25499	639B		X		X	S	
	Timer remaining time 5	9116	239C	25500	639C		X		X	S	
	Timer remaining time 6	9117	239D	25501	639D		X		X	S	
	Timer remaining time 7	9118	239E	25502	639E		X		X	S	
	Timer remaining time 8	9119	239F	25503	639F		X		X	S	
	STEP operation No.	9120	23A0	25504	63A0		X		X	S	
	STEP operation remaining time	9121	23A1	25505	63A1		X		X	S	
	STEP operation remaining time (sec.)	9122	23A2	25506	63A2		X		X	S	
	LSP value in use	9123	23A3	25507	63A3					P	Same as RAM address 14593 (decimal). (Note 3)
	PV before ratio, bias, and filter	9124	23A4	25508	63A4		X		X	P	
RSP before ratio, bias, and filter	9125	23A5	25509	63A5		X		X	P		
Status	Input alarm status	9201	23F1	25585	63F1		X		X	—	Bit 0: AL01 (PV over-range) Bit 1: AL01 (PV under-range) Bit 2: AL03 (CJ, RTD burnout) Bit 3: Undefined. Bit 4: AL05 (RSP over-range) Bit 5: AL06 (RSP under-range) Bit 6: AL07 (MFB burnout) Bit 7 to 8: Undefined. Bit 9: AL10 (Motor adjustment failure) Bit 10: AL11(CT over-range) Bit 11 to 15: Undefined.

(Note 3) If the value is read immediately after it has been written into the SP or the LSP in use, the value still may not be changed. The value is updated after the cycle time has elapsed.

(Note 4) If the SP or the LSP in use is read immediately after the value has been written into the LSP group selection, the value still may not be changed. The value is updated after the cycle time has elapsed.

(Continue on next page.)

Chapter 9. LIST OF COMMUNICATION DATA

Bank	Item name	RAM address		EEPROM address		RAM		EEPROM		Decimal point information	Notes
		Decimal	Hexadecimal	Decimal	Hexadecimal	Read	Write	Read	Write		
Status	Instrument alarm status	9202	23F2	25586	63F2		X		X	—	Bits 0 to 1: Undefined. Bit 2: AL70 (A/D) Bit 3: AL95 (Set data) Bit 4: AL96 (Adjustment data) Bit 5: AL97 (Set data/RAM) Bit 6: AL98 (Adjustment data/RAM) Bit 7: AL99 (ROM) Bits 8 to 15 Undefined.
	Internal Event/Internal Contact function	9203	23F3	25587	63F3		X		X	—	Bit 0 to 7: Internal event 1 to 8 Bit 8 to 12: Internal contact 1 to 5 Bit 13 to 15: Undefined.
	Control status	9204	23F4	25588	63F4		X		X	—	Bit 0: MANUAL mode Bit 1: READY mode Bit 2: RSP mode Bit 3: During AT Bit 4: During ST (Invalid in this unit) Bit 5: During SOAK of step operation Bit 6: During SP ramp Bit 7: During SP ramp-up Bit 8: During SP ramp-down Bits 9 to 10: Undefined. Bit 11: During estimate of MFB Bit 12: During adjustment of MFB Bit 13: PID (Heat) is being used. Bit 14: PID (Cool) is being used. Bit 15: Undefined.
	DO status	9205	23F5	25589	63F5		X		X	—	Same as RAM address 14337 (decimal). Bit 0: Control output 1 Bit 1: Control output 2 Bit 2: Event output 1 Bit 3: Event output 2 Bit 4: Event output 3 Bits 5 to 15: Undefined.
	DI status	9206	23F6	25590	63F6		X		X	—	Same as RAM address 14338 (decimal). Bit 0: DI1 Bit 1: DI2 Bit 2: DI3 Bit 3: DI4 Bits 4 to 15: Undefined.
	Communication DI (DI1 to 4)	9207	23F7	25591	63F7					—	Bit 0: Communication DI1 Bit 1: Communication DI2 Bit 2: Communication DI3 Bit 3: Communication DI4
	Communication DI1	9208	23F8	25592	63F8					—	
	Communication DI2	9209	23F9	25593	63F9					—	
	Communication DI3	9210	23FA	25594	63FA					—	
	Communication DI4	9211	23FB	25595	63FB					—	
Tag	Tag 1	9301	2455	25685	6455					—	Display and setting cannot be made with the console.
	Tag 2	9302	2456	25686	6456					—	Same as above.
	Tag 3	9303	2457	25687	6457					—	Same as above.

(Continue on next page.)

Bank	Item name	RAM address		EEPROM address		RAM		EEPROM		Decimal point information	Notes	
		Decimal	Hexadecimal	Decimal	Hexadecimal	Read	Write	Read	Write			
Tag	Tag 4	9304	2458	25688	6458					—	Display and setting cannot be made with the console.	
	Tag 5	9305	2459	25689	6459					—	Same as above.	
	Tag 6	9306	245A	25690	645A					—	Same as above.	
	Tag 7	9307	245B	25691	645B					—	Same as above.	
	Tag 8	9308	245C	25692	645C					—	Same as above.	
	Tag 9	9309	245D	25693	645D					—	Same as above.	
	Tag 10	9310	245E	25694	645E					—	Same as above.	
	Tag 11	9311	245F	25695	645F					—	Same as above.	
	Tag 12	9312	2460	25696	6460					—	Same as above.	
	Tag 13	9313	2461	25697	6461					—	Same as above.	
	Tag 14	9314	2462	25698	6462					—	Same as above.	
	Tag 15	9315	2463	25699	6463					—	Same as above.	
	Tag 16	9316	2464	25700	6464					—	Same as above.	
	PID	Proportional band (P-1)	12288	3000	28672	7000					1	
		Integral time (I-1)	12289	3001	28673	7001					S	
		Derivative time (D-1)	12290	3002	28674	7002					S	
Manual reset (RE-1)		12291	3003	28675	7003					1		
Output low limit (OL-1)		12292	3004	28676	7004					1		
Output high limit (OH-1)		12293	3005	28677	7005					1		
Proportional band (P-2)		12294	3006	28678	7006					1		
Integral time (I-2)		12295	3007	28679	7007					S		
Derivative time (D-2)		12296	3008	28680	7008					S		
Manual reset (RE-2)		12297	3009	28681	7009					1		
Output low limit (OL-2)		12298	300A	28682	700A					1		
Output high limit (OH-2)		12299	300B	28683	700B					1		
Proportional band (P-3)		12300	300C	28684	700C					1		
Integral time (I-3)		12301	300D	28685	700D					S		
Derivative time (D-3)		12302	300E	28686	700E					S		
Manual reset (RE-3)		12303	300F	28687	700F					1		
Output low limit (OL-3)		12304	3010	28688	7010					1		
Output high limit (OH-3)		12305	3011	28689	7011					1		
Proportional band (P-4)		12306	3012	28690	7012					1		
Integral time (I-4)		12307	3013	28691	7013					S		
Derivative time (D-4)		12308	3014	28692	7014					S		
Manual reset (RE-4)		12309	3015	28693	7015					1		
Output low limit (OL-4)		12310	3016	28694	7016					1		
Output high limit (OH-4)		12311	3017	28695	7017					1		
Proportional band (P-5)		12312	3018	28696	7018					1		
Integral time (I-5)		12313	3019	28697	7019					S		
Derivative time (D-5)		12314	301A	28698	701A					S		
Manual reset (RE-5)		12315	301B	28699	701B					1		
Output low limit (OL-5)		12316	301C	28700	701C					1		
Output high limit (OH-5)		12317	301D	28701	701D					1		
Proportional band (P-6)		12318	301E	28702	701E					1		
Integral time (I-6)		12319	301F	28703	701F					S		
Derivative time (D-6)	12320	3020	28704	7020					S			
Manual reset (RE-6)	12321	3021	28705	7021					1			
Output low limit (OL-6)	12322	3022	28706	7022					1			
Output high limit (OH-6)	12323	3023	28707	7023					1			
Proportional band (P-7)	12324	3024	28708	7024					1			

(Continue on next page.)

Chapter 9. LIST OF COMMUNICATION DATA

Bank	Item name	RAM address		EEPROM address		RAM		EEPROM		Decimal point information	Notes
		Decimal	Hexadecimal	Decimal	Hexadecimal	Read	Write	Read	Write		
PID	Integral time (I-7)	12325	3025	28709	7025					S	
	Derivative time (D-7)	12326	3026	28710	7026					S	
	Manual reset (RE-7)	12327	3027	28711	7027					1	
	Output low limit (OL-7)	12328	3028	28712	7028					1	
	Output high limit (OH-7)	12329	3029	28713	7029					1	
	Proportional band (P-8)	12330	302A	28714	702A					1	
	Integral time (I-8)	12331	302B	28715	702B					S	
	Derivative time (D-8)	12332	302C	28716	702C					S	
	Manual reset (RE-8)	12333	302D	28717	702D					1	
	Output low limit (OL-8)	12334	302E	28718	702E					1	
	Output high limit (OH-8)	12335	302F	28719	702F					1	
	Proportional band for cool side (P-1.C)	12336	3030	28720	7030					1	
	Integral time for cool side (I-1.C)	12337	3031	28721	7031					S	
	Derivative time for cool side (D-1.C)	12338	3032	28722	7032					S	
	(Reserved for future extension.)	12339	3033	28723	7033	Δ	Δ	Δ	Δ	—	
	Output low limit for cool side (OL1.C)	12340	3034	28724	7034					1	
	Output high limit for cool side (OH1.C)	12341	3035	28725	7035					1	
	Proportional band for cool side (P-2.C)	12342	3036	28726	7036					1	
	Integral time for cool side (I-2.C)	12343	3037	28727	7037					S	
	Derivative time for cool side (D-2.C)	12344	3038	28728	7038					S	
	(Reserved for future extension.)	12345	3039	28729	7039	Δ	Δ	Δ	Δ	—	
	Output low limit for cool side (OL2.C)	12346	303A	28730	703A					1	
	Output high limit for cool side (OH2.C)	12347	303B	28731	703B					1	
	Proportional band for cool side (P-3.C)	12348	303C	28732	703C					1	
	Integral time for cool side (I-3.C)	12349	303D	28733	703D					S	
	Derivative time for cool side (D-3.C)	12350	303E	28734	703E					S	
	(Reserved for future extension.)	12351	303F	28735	703F	Δ	Δ	Δ	Δ	—	
	Output low limit for cool side (OL3.C)	12352	3040	28736	7040					1	
	Output high limit for cool side (OH3.C)	12353	3041	28737	7041					1	
	Proportional band for cool side (P-4.C)	12354	3042	28738	7042					1	
	Integral time for cool side (I-4.C)	12355	3043	28739	7043					S	
	Derivative time for cool side (D-4.C)	12356	3044	28740	7044					S	
	(Reserved for future extension.)	12357	3045	28741	7045	Δ	Δ	Δ	Δ	—	
	Output low limit for cool side (OL4.C)	12358	3046	28742	7046					1	
	Output high limit for cool side (OH4.C)	12359	3047	28743	7047					1	
	Proportional band for cool side (P-5.C)	12360	3048	28744	7048					1	
	Integral time for cool side (I-5.C)	12361	3049	28745	7049					S	
	Derivative time for cool side (D-5.C)	12362	304A	28746	704A					S	
	(Reserved for future extension.)	12363	304B	28747	704B	Δ	Δ	Δ	Δ	—	
	Output low limit for cool side (OL5.C)	12364	304C	28748	704C					1	
	Output high limit for cool side (OH5.C)	12365	304D	28749	704D					1	
	Proportional band for cool side (P-6.C)	12366	304E	28750	704E					1	
Integral time for cool side (I-6.C)	12367	304F	28751	704F					S		
Derivative time for cool side (D-6.C)	12368	3050	28752	7050					S		
(Reserved for future extension.)	12369	3051	28753	7051	Δ	Δ	Δ	Δ	—		
Output low limit for cool side (OL6.C)	12370	3052	28754	7052					1		
Output high limit for cool side (OH6.C)	12371	3053	28755	7053					1		
Proportional band for cool side (P-7.C)	12372	3054	28756	7054					1		
Integral time for cool side (I-7.C)	12373	3055	28757	7055					S		
Derivative time for cool side (D-7.C)	12374	3056	28758	7056					S		

(Continue on next page.)

Bank	Item name	RAM address		EEPROM address		RAM		EEPROM		Decimal point information	Notes
		Decimal	Hexadecimal	Decimal	Hexadecimal	Read	Write	Read	Write		
PID	(Reserved for future extension.)	12375	3057	28759	7057	Δ	Δ	Δ	Δ	—	
	Output low limit for cool side (OL7.C)	12376	3058	28760	7058					1	
	Output high limit for cool side (OH7.C)	12377	3059	28761	7059					1	
	Proportional band for cool side (P-8.C)	12378	305A	28762	705A					1	
	Integral time for cool side (I-8.C)	12379	305B	28763	705B					S	
	Derivative time for cool side (D-8.C)	12380	305C	28764	705C					S	
	(Reserved for future extension.)	12381	305D	28765	705D	Δ	Δ	Δ	Δ	—	
	Output low limit for cool side (OL8.C)	12382	305E	28766	705E					1	
	Output high limit for cool side (OH8.C)	12383	305F	28767	705F					1	
Event	Internal Event 1 main setting	13056	3300	29440	7300					S	
	Internal Event 1 sub-setting	13057	3301	29441	7301					S	
	Internal Event 2 main setting	13058	3302	29442	7302					S	
	Internal Event 2 sub-setting	13059	3303	29443	7303					S	
	Internal Event 3 main setting	13060	3304	29444	7304					S	
	Internal Event 3 sub-setting	13061	3305	29445	7305					S	
	Internal Event 4 main setting	13062	3306	29446	7306					S	
	Internal Event 4 sub-setting	13063	3307	29447	7307					S	
	Internal Event 5 main setting	13064	3308	29448	7308					S	
	Internal Event 5 sub-setting	13065	3309	29449	7309					S	
	Internal Event 6 main setting	13066	330A	29450	730A					S	
	Internal Event 6 sub-setting	13067	330B	29451	730B					S	
	Internal Event 7 main setting	13068	330C	29452	730C					S	
	Internal Event 7 sub-setting	13069	330D	29453	730D					S	
	Internal Event 8 main setting	13070	330E	29454	730E					S	
	Internal Event 8 sub-setting	13071	330F	29455	730F					S	
LSP	LSP1	13312	3400	29696	7400					P	
	LSP2	13313	3401	29697	7401					P	
	LSP3	13314	3402	29698	7402					P	
	LSP4	13315	3403	29699	7403					P	
	LSP5	13316	3404	29700	7404					P	
	LSP6	13317	3405	29701	7405					P	
	LSP7	13318	3406	29702	7406					P	
	LSP8	13319	3407	29703	7407					P	
Instrument status 1	Typical alarm	14336	3800	30720	7800		X		X	—	Bit 0: PV failure (AL01 to 03) Bits 1 to 11: Undefined. Bit 12: Hardware failure (AL70) Bit 13: Parameter failure (AL95/97) Bit 14: Adjustment data failure (AL96/98) Bit 15: ROM failure (AL99)
	DO status	14337	3801	30721	7801		X		X	—	Same as RAM address 9205 (decimal).
	DI status	14338	3802	30722	7802		X		X	—	Same as RAM address 9206 (decimal).

(Continue on next page.)

Chapter 9. LIST OF COMMUNICATION DATA

Bank	Item name	RAM address		EEPROM address		RAM		EEPROM		Decimal point information	Notes
		Decimal	Hexadecimal	Decimal	Hexadecimal	Read	Write	Read	Write		
Instrument status 2	RUN/READY	14352	3810	30736	7810		X		X	—	
	AUTO/MANUAL	14353	3811	30737	7811		X		X	—	
	AT stop/start	14354	3812	30738	7812		X		X	—	
	LSP/RSP	14355	3813	30739	7813		X		X	—	Writing is enabled under no DI Assignment conditions. Same as RAM address 9003(decimal).
	PV	14356	3814	30740	7814		X		X	P	
	SP (Target value)	14357	3815	30741	7815		X		X	P	
	Manipulated Variable (MV)	14358	3816	30742	7816		X		X	1	
Instrument status 3	RSP	14416	3850	30800	7850		X		X	P	Same as RAM address 7001 (decimal).
	MFB (Motor opening feedback value)	14417	3851	30801	7851		X		X	1	Same as RAM address 9108 (decimal).
	Current transformer (CT) input 1 current value	14418	3852	30802	7852		X		X	1	Same as RAM address 9110 (decimal).
	Current transformer (CT) input 2 current value	14419	3853	30803	7853		X		X	1	Same as RAM address 9111 (decimal).
	Heat MV (for heat/cool control)	14420	3854	30804	7854		X		X	1	Same as RAM address 9106 (decimal).
	Cool MV (for heat/cool control)	14421	3855	30805	7855		X		X	1	Same as RAM address 9107 (decimal).
Operation	LSP group selection	14592	3900	30976	7900		*		*	—	Writing is enabled under no DI Assignment conditions. Same as RAM address 9103 (decimal).
	LSP value in use	14593	3901	30977	7901					P	Same as RAM address 9123 (decimal).
	Manual manipulated variable (MV)	14594	3902	30978	7902		*		*	1	Writing is enabled in the MANUAL mode. Same as RAM address 9105 (decimal).
	RUN/READY	14595	3903	30979	7903		*		*	—	Writing is enabled under no DI Assignment conditions. Same as RAM address 9002 (decimal).
	AUTO/MANUAL	14596	3904	30980	7904		*		*	—	Writing is enabled under no DI Assignment and other conditions. Same as RAM address 9001 (decimal).
	AT stop/start	14597	3905	30981	7905		*		*	—	Writing is enabled under no DI Assignment and other conditions. Same as RAM address 9004 (decimal).
	LSP/RSP	14598	3906	30982	7906		*		*	—	Writing is enabled under no DI Assignment conditions. Same as RAM address 9003 (decimal).

(Continue on next page.)

Bank	Item name	RAM address		EEPROM address		RAM		EEPROM		Decimal point information	Notes
		Decimal	Hexadecimal	Decimal	Hexadecimal	Read	Write	Read	Write		
PID group in use	Proportional band (P)	14848	3A00	31232	7A00					1	
	Integral time (I)	14849	3A01	31233	7A01					S	
	Derivative time (D)	14850	3A02	31234	7A02					S	
	Manual reset	14851	3A03	31235	7A03					1	
	MV low limit	14852	3A04	31236	7A04					1	
	MV high limit	14853	3A05	31237	7A05					1	
	Proportional band for cool side	14854	3A06	31238	7A06					1	
	Integral time for cool side	14855	3A07	31239	7A07					S	
	Derivative time for cool side	14856	3A08	31240	7A08					S	
	(Reserved for future extension.)	14857	3A09	31241	7A09	Δ	Δ	Δ	Δ	1	
	Output low limit for cool side	14858	3A0A	31242	7A0A					1	
Output high limit for cool side	14859	3A0B	31243	7A0B					1		

Chapter 10. MAINTENANCE AND TROUBLESHOOTING

■ Maintenance

● Cleaning

When removing dirt from the instrument, wipe it off with a soft cloth rag. At this time, do not use any organic solvent, such as paint thinner or benzene.

● Part replacement

Do not replace any parts of this unit.

● Fuse replacement

When replacing the fuse connected to the electric wiring, always use the specified standard fuse.

Standard	IEC127
Shut-down speed	Slow-action type (T)
Rated voltage	250V
Rated current	0.5A

■ Alarm displays and corrective action

The following table shows the alarm displays and corrective actions if any failure occurs in this unit:

Alarm code	Failure name	Cause	Corrective action
<i>AL01</i>	PV input failure (Over-range)	Sensor burnout, incorrect wiring, incorrect PV input type setting	Check the wiring. Set the PV input type again.
<i>AL02</i>	PV input failure (Under-range)	Sensor burnout, incorrect wiring, incorrect PV input type setting	
<i>AL03</i>	CJ failure	Terminal temperature is faulty (thermocouple).	Check the ambient temperature.
	PV input failure	Sensor burnout, incorrect wiring (RTD)	Check the wiring.
<i>AL05</i>	RSP input failure (Over-range) (Displayed only in the RSP mode.)	Sensor burnout, incorrect wiring, incorrect RSP input type setting	Check the wiring. Set the RSP input type again.
<i>AL06</i>	RSP input failure (Under-range) (Displayed only in the RSP mode.)	Sensor burnout, incorrect wiring, incorrect RSP input type setting	Check the wiring. Set the RSP input type again.
<i>AL07</i>	MFB input failure	Burnout, incorrect wiring	Check the wiring. Check the MFB input value.
<i>AL10</i>	Motor adjustment failure	Check for burnout or incorrect wiring. Motor power shutdown.	Readjust the motor after checking the wiring and motor power.
<i>AL11</i>	CT input failure (over-range) (CT input 1 or 2, or both)	A current exceeding the upper limit of the display range was measured. The number of CT turns or the number of CT power wire loops is incorrectly set, or wiring is incorrect.	Use a CT with the correct number of turns for the display range, reset the number of CT turns, reset the number of CT power wire loops, and/or check the wiring.
<i>AL70</i>	A/D conversion failure	A/D converter is faulty.	Replace the unit.
<i>AL95</i>	Parameter failure	Data is corrupted by noise, or power is shut-down while the data is being set.	<ul style="list-style-type: none"> • Restart the unit. • Set the data again (set data for AL95/97 and adjustment data for AL96/98). • Replace the unit.
<i>AL96</i>	Adjustment data failure	Data is corrupted by noise, or power is shut-down while the data is being set.	
<i>AL97</i>	Parameter failure (RAM area)	Data is corrupted by noise.	
<i>AL98</i>	Adjustment data failure (RAM area)	Data is corrupted by noise.	
<i>AL99</i>	ROM failure	ROM (memory) is faulty.	<ul style="list-style-type: none"> • Restart the unit. • Replace the unit.

⚠ Handling Precautions

- If ROM version 1 of the instrument information bank (*AL02*) is prior to 2.04, CT input failure (AL11) is not displayed.

■ Behavior in case of PV input failure

(1) AL01, 02, or 03 occurs.

Control output: It is possible to make the settings so that the control action is continued or stopped.

Other actions: Actions are continued.

(2) Alarm occurs other than those shown above.

All actions are continued.

The following table shows the indications and alarms of this unit by the sensor type if PV input failure occurs:

● Thermocouple

Failure status	Range No.	Indication value	Alarm code
Sensor burnout		Upscale (110%FS)	AL01
CJ failure		PV having incorrect cold junction compensation.	AL03
Over-range, burnout	19 (PLII)	1365°C (105%FS)	AL01

● RTD

Failure status	Range No.	Indication value	Alarm code
RTD burnout		Upscale (110%FS)	AL01
A-wire burnout		Upscale (110%FS)	AL01
B-wire burnout		Upscale (110%FS)	AL01, AL03
C-wire burnout		Upscale (110%FS)	AL01, AL03
2 or 3-wire burnout		Upscale (110%FS)	AL01, AL03
A and B-wire short-circuit		Downscale (-10%FS)	AL02
A and C-wire short-circuit		Downscale (-10%FS)	AL02
A and B-wire/A and C-wire short-circuit	41,43 (Pt100)	-235°C (-5%FS)	AL02
A and B-wire/A and C-wire short-circuit	42,44 (JPt100)	-235°C (-5%FS)	AL02

● DC voltage/DC current

Failure status	Range No.	Indication value	Alarm code
Burnout	81 (0 to 10mV)	Upscale (110%FS)	AL01
	82 (-10 to +10mV)	Upscale (110%FS)	AL01
	83 (0 to 100mV)	Upscale (110%FS)	AL01
	84 (0 to 1V)	Downscale (-3%FS)	AL02
	86 (1 to 5V)	Downscale (-10%FS)	AL02
	87 (0 to 5V)	Downscale (-3%FS)	AL02
	88 (0 to 10V)	Downscale (0%FS)	None
	89 (0 to 20mA)	Indefiniteness (around 0%FS)	None
	90 (4 to 20mA)	Downscale (-10%FS)	AL02

■ Behavior in case of RSP input failure

When an alarm occurs, all actions are continued.

The following table shows the indications and alarms of this unit if RSP input failure occurs:

Failure status	Range No.	Indication value	Alarm code
Burnout	0 (4 to 20mA)	Downscale (-10%FS)	AL06
	1 (0 to 20mA)	Indefiniteness (around 0%FS)	None
	2 (0 to 5V)	Downscale (-10%FS)	AL06
	3 (1 to 5V)	Downscale (-10%FS)	AL06
	4 (0 to 10V)	Downscale (-10%FS)	AL06

Chapter 11. CALIBRATION

CAUTION



Do not change the mode to the calibration mode while the control object is being operated.
When this unit is put in the calibration mode, the control output and event output enter the fixed status and they do not function. Always start the calibration by considering this point carefully.

Handling Precautions

It may be required to disconnect and reconnect the wiring for calibration. At this time, strictly observe the warnings and cautions about wiring stated in Chapter 4, WIRING.

This chapter describes how to calibrate this unit.

To calibrate this unit, the SLP-C35 Smart Loader Package is required.

■ Starting the calibration

Start up the SLP-C35 Smart Loader Package. On the menu screen, select [Calibration (J)] from the [Menu (M)] pull-down menu. The [Calibrate] confirmation screen will appear.

On this screen, select [OK]. The Calibration screen will appear and this unit enters the calibration mode.

When this unit is in the calibration mode, “tEst” will appear on the lower display. However, note that another message appears when inspecting the LED.

Handling Precautions

- Azbil Corporation shall not be held responsible for any defects arising from improper calibration made by the customer.
- To return the unit to the calibration status of the default settings before shipment during calibration, follow the steps below. From the pull-down menu, select [Command] → [Data retrieval]. The data, which has been calibrated, is disposed of and the data is then returned to the default settings before shipment. If this operation is performed accidentally during calibration, all contents, which have been calibrated by the customer, will be lost.

■ Exiting the calibration

To exit the calibration, perform either of the following operations:

- (1) On the Calibration screen of the Smart Loader Package, select [Quit (Q)] from the [File (F)] pull-down menu.
- (2) Click [X] at the upper right corner of the Calibration screen to close the screen. The screen will be returned to the menu screen and the unit also returns to the normal mode.

Handling Precautions

If the loader cable is disconnected before starting the calibration exit operation with the Smart Loader Package, this unit is continuously kept in the calibration mode. At this condition, turn OFF the power, and turn it ON again. The unit will return to the normal mode.

■ Cautions before starting the calibration

When calibrating the unit, strictly observe the following cautions. Failure to do so may cause inaccuracy:

- Before starting the calibration, supply the power to this unit for at least 1 hr.
- The ambient temperature of the calibration place must conform to the standard conditions specified in the unit specifications.
- Do not calibrate the unit in a place where it is in contact with the wind or during ambient temperature fluctuation.
- Do not calibrate the unit with the measuring instruments having lower specifications stated in the next section, **■ Measuring instruments required for calibration**.

■ Measuring instruments required for calibration

Measuring instrument	Specifications
Reference current/voltage generator	Accuracy: $\pm 0.1\%$ or less, Minimum resolution: 100 μV or less (voltage), Minimum resolution: 100 μA or less (current)
Resistor	Accuracy: $\pm 0.1\%$ or less, Minimum resolution: 0.1 Ω or less
Ammeter	Accuracy: $\pm 0.1\%$ or less, Minimum resolution: 1 μA or less
Voltmeter	Accuracy: $\pm 0.1\%$ or less, Minimum resolution: 1mV or less
Thermometer	Accuracy: $\pm 0.1^\circ\text{C}$ or less, Minimum resolution: 0.1 $^\circ\text{C}$ or less

■ Calibration procedures

● **I/O check**

- (1) Select the [I/O Check] tab.
- (2) Select a desired item from the check contents.
- (3) Click [Execute].

The input system (key and digital input) is shown on the personal computer screen while the input status (ON/OFF) of this unit is being read continuously.

For the output system (control output and event output), the status (ON/OFF) you have checked on desired check boxes is output from the output terminal of this unit.

● **PV input calibration**

- (1) Select the [PV Calibration] tab.
- (2) Select the model, [4: C25/26/35/36 T/C], [5: C25/26/35/36 RTD], or [6: C25/26/35/36 LIN].
- (3) Select the gain No. in the ascending order and perform the operation from step (4).
- (4) Click [Read].
- (5) Apply the voltage, current, and resistance values written next to the gain No. to the PV input terminal.

For details about how to connect measuring instruments in the apply status, refer to the following figures:

- The PV input type is T/C (thermocouple).

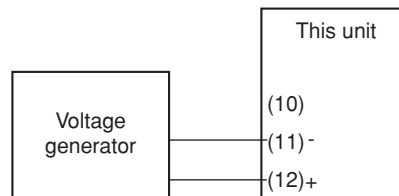

- The PV input type is RTD.

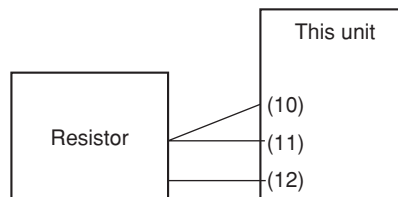

- The PV input type is LIN (DC voltage/DC current).

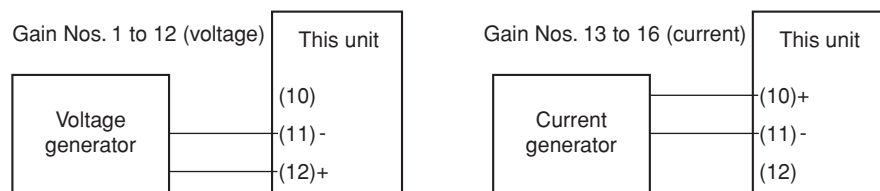

(6) Keep the apply status for approximately 30s.

(7) Click [Write].

(8) Return to step (3) and repeat the procedure until the final gain No. is completed.

! Handling Precautions

- In the PV input calibration, always adjust all gains.
- Do not leave the PV input terminal open during heat-up between power ON of this unit and starting of calibration. When the input type is thermocouple or DC voltage, put the unit in the 0 volt input (or terminals are short-circuited) status. When the input type is RTD, put the unit in the 100 Ω -input (or terminals are short-circuited) status.

● RSP input calibration

- (1) Select the [PV Calibration] tab.
- (2) Select the model [7: C35/36 RSP].
- (3) Select the gain No. in the ascending order and perform the operation from step (4).
- (4) Click [Read].
- (5) Apply the voltage and current values written next to the gain No. to the PV input terminal.

For details about how to connect measuring instruments in the apply status, refer to the following Figures:

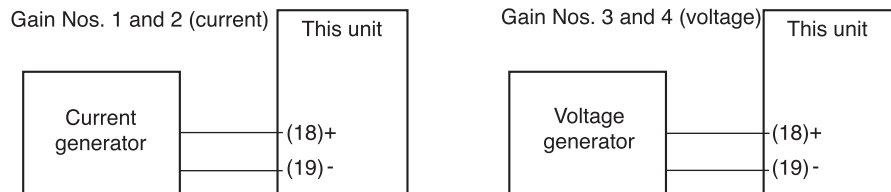

- (6) Keep the apply status for approximately 30s.
- (7) Click [Write].
- (8) Return to step (3) and repeat the procedure until the final gain No. is completed.

! Handling Precautions

- In the RSP input calibration, it is always necessary to adjust all gains.
- Do not leave the RSP input terminal open during heat-up between power ON of this unit and starting of calibration. When the input type is DC voltage, put the unit in the 0 volt input (or terminals are short-circuited) status.

● Current Transformer (CT) input calibration

- (1) Select the [CT input calibration] tab.
- (2) Select a desired channel to be calibrated.
- (3) Select [Zero] from the zero span selection items.
(When selecting a channel, perform the [Zero] calibration first, and then perform the [Span] calibration next since “Zero/Span” is set for one channel.)
- (4) Click [Read].
- (5) A current value of “0” is applied to the CT input terminal of the channel you have selected and keep the apply status for approximately 30 sec. For details about how to connect measuring instruments in the apply status, refer to the following Figures:

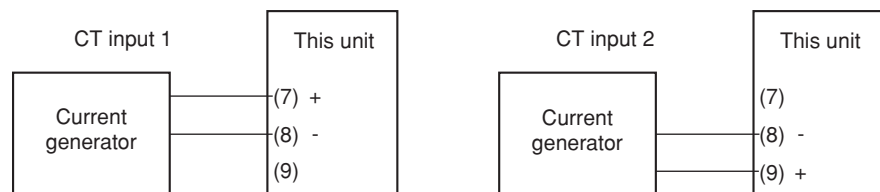

- (6) Click [Write].
- (7) Select [Span] from the zero span selection items.
- (8) Click [Read].
- (9) Apply a span current value to the CT input terminal of the channel you have selected and keep the apply status for approximately 30s.
- (10) Click [Write].
- (11) If any channels to be calibrated remain, return to operation step (2).

ⓘ Handling Precautions

To calibrate the CT input, connect the DC current (mA) to the input terminal.

● **Current output/continuous voltage output calibration**

- (1) Select the [Analog Output Calibration] tab.
- (2) Select a desired channel to be calibrated.
Select [ch1] for control output 1, [ch2] for control output 2, and [ch3] for auxiliary output.
- (3) Select [Zero] from the zero span selection items.
(When selecting a channel, perform the [Zero] calibration first, and then perform the [Span] calibration next since “Zero/Span” is set for one channel.)
- (4) When clicking [Read], the zero calibration current/continuous voltage is output to the output terminal of the channel you have selected.
- (5) Keep this status for approximately 30s.
- (6) Read the current value in units of 0.001 mA from the ammeter or the voltage value in units of 0.001V from the voltmeter, input them in [Current (mA)/Voltage (V)], and click [Write].
- (7) Select [Span] from the zero span selection items.
- (8) When clicking [Read], the span calibration current/continuous voltage is output to the output terminal of the channel you have selected.
- (9) Keep this status for approximately 30s.
- (10) Read the current value in units of 0.001 mA from the ammeter or the voltage value in units of 0.001V from the voltmeter, input them in [Current (mA)/Voltage (V)], and click [Write].
- (11) If any channels to be calibrated remain, return to operation step (2).
For details about how to connect measuring instruments, refer to the following Figures:

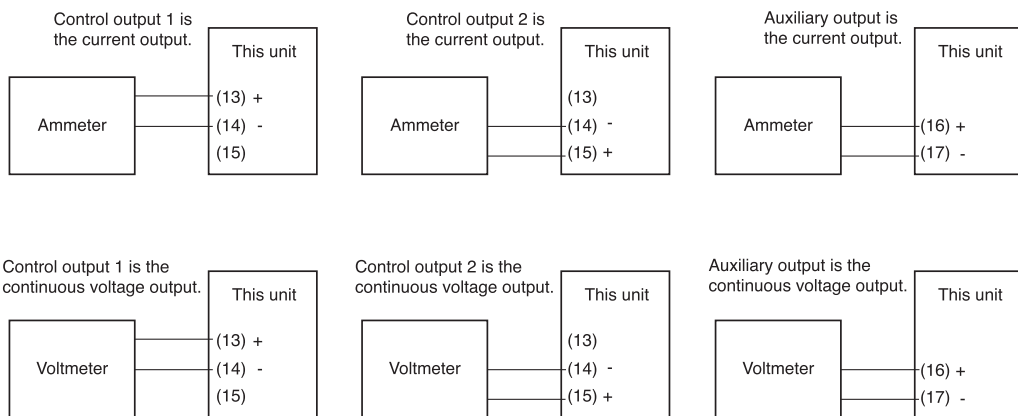

Chapter 12. DISPOSAL

When disposing of this unit, dispose of it appropriately as an industrial waste in accordance with local laws and regulations.

Chapter 13. SPECIFICATIONS

■ Specifications

● PV input

Thermocouple:	K,J,E,T,R,S,B,N (JIS C1602-1995) PL II (Engelhard Industries Data (ITS90)) WRe5-26 (ASTM E988-96(Reapproved 2002)) Ni-NiMo (ASTM E1751-00) PR40-20 (Johnson Matthey Data) DIN U,DIN L (DIN 43710-1985) Gold iron chromel (Hayashidenko Data)
Resistance temperature detector (RTD):	Pt100 (JIS C1604-1997) JPt100 (JIS C1604-1989)
DC voltage:	0 to 10mV, -10 to +10mV, 0 to 100mV, 0 to 1V, 1 to 5V, 0 to 5V, 0 to 10V
DC current:	0 to 20mA, 4 to 20mA
Selection of input type:	A desired type can be selected (full-multi range).
Sampling cycle time:	100ms
Indication accuracy:	$\pm 0.1\%FS \pm 1$ digit, $\pm 0.2\%FS \pm 1$ digit in the negative area of the thermocouple (Specified by the input conversion at an ambient temperature of $23 \pm 2^\circ C$) However, the following ranges have different values: <ul style="list-style-type: none">• Sensor type B (range 17): $\pm 4\%FS$ at $260^\circ C$ or less, $\pm 0.4\%FS$ at 260 to $800^\circ C$, $\pm 0.2\%FS$ at 800 to $1800^\circ C$ The low limit for indication is $20^\circ C$. However, if ROM version 1 of the instrument information bank (2.02) is prior to 2.04, the low limit for indication is $-180^\circ C$.• Sensor type R (range 15), sensor type S (range 16): $\pm 0.2\%FS$ at $100^\circ C$ or less, $\pm 0.15\%FS$ at 100 to $1600^\circ C$• Sensor type PR40-20 (range 23): $\pm 2.5\%FS$ at 0 to $300^\circ C$, $\pm 1.5\%FS$ at 300 to $800^\circ C$, $\pm 0.5\%FS$ at 800 to $1900^\circ C$• Sensor type golden iron chromel (range 26): $\pm 1.5K$• Sensor type Pt, JPt (RTD) (range 55 to 62): $\pm 0.15\%FS$• Sensor type 0 to 10mV (DC voltage) (range 81): $\pm 0.15\%FS$ Note: For the indication accuracy of the unit in combination with zener barriers, see chapter 4.
Cold junction compensation accuracy:	$\pm 0.5^\circ C$ (at an ambient temperature of $23 \pm 2^\circ C$) $\pm 1.0^\circ C$ (at an ambient temperature of 15 to $35^\circ C$) $\pm 1.5^\circ C$ (at an ambient temperature of 0 to $15^\circ C$ or 35 to $50^\circ C$)
Cold junction compensation method:	Compensation inside or outside (only at $0^\circ C$) the measuring instrument can be selected.
PV bias:	-1999 to +9999 or -199.9 to +999.9

• Thermocouple (T/C) input

Input bias current:	+0.2 μA (flows from terminal A.)
Burnout indication:	Upscale + AL01
Diameter of the applicable thermocouple or compensating wire:	0.3 to 0.65mm
Allowabl input voltage:	-0.5 to +12V

• **Resistance temperature detector (RTD) input**

Input bias current: Approx. +1mA (flows from terminal A.)
 Burnout indication: RTD burnout or A-wire burnout Upscale + AL01
 B-wire burnout or C-wire burnout . . . Upscale + AL01, AL03
 2 or more wires burnout Upscale + AL01, AL03

Effect of wiring resistance: Max. $\pm 0.05\%FS/\Omega$

Allowable wiring resistance: 10 Ω or less for range No. 53 to 62 (Zener barrier cannot be used.)
 85 Ω or less for ranges other than above range (including the resistance of the Zener barrier)

Allowable input voltage: -0.5 to +12V

• **DC voltage input**

Input impedance: Min. 1M Ω

Input bias current: 1V range or less Max. 1 μ A (flows to the (+) terminal)
 0 to 5V, 1 to 5V range Max. 3.5 μ A (flows to the (+) terminal)
 0 to 10V range Max. 7 μ A (flows to the (+) terminal)

Burnout indication: Downscale + AL02
 However, the burnout cannot be detected in a range of 0 to 10V.

Allowable input voltage: -0.5 to +12V

• **DC current input**

Input impedance: Max. 100 Ω

Burnout indication: Downscale + AL02
 However, the burnout cannot be detected in a range of 0 to 20mA.

Allowable input current: Max. 30mA

Allowable input voltage: Max.4V (a higher voltage might cause input circuit failure)

* When the power to this controller is turned off, the current input circuit is cut off. If you connect two or more current-input type controllers in series, change the current input to voltage input by connecting a resistor (No. 81401325, sold separately). See Chapter 4.

● **Motor feedback potentiometer input (R1 model)**

Allowable resistance: 100 to 2500 Ω

Burnout detection: AL07 indication

● **RSP input**

Input type: Linear 0 to 20mA/4 to 20mA or linear 0 to 5V/1 to 5V/0 to 10V

Scaling: Possible in a range of -1999 to +9999. It is also possible to set the decimal point position.

Sampling cycle: 100ms

Indication accuracy: $\pm 0.1\%FS \pm 1$ digit (at an ambient temperature of 23 $\pm 2^\circ$ C)

• **Voltage input specifications**

Input impedance: Min. 1M Ω

Input bias current: 0 to 5V, 1 to 5V range Max. 3 μ A (flows to the (+) terminal)
 0 to 10V range Max. 5 μ A (flows to the (+) terminal)

Burnout indication: Downscale + AL06

• **Current input specifications**

Input impedance: Max. 100 Ω

Burnout indication: Downscale + AL06
 However, the burnout cannot be detected in a range of 0 to 20mA.

Allowable input current: Max. 30mA

Allowable input voltage: Max.4V(a higher voltage might cause device failure)

● External contact input

Number of input points:	4 points
Input type:	Potential free contact or open collector
Allowable ON contact resistance:	Max. 250Ω
Allowable OFF contact resistance:	Min.100 kΩ
Allowable ON-state residual voltage:	Max. 1.0V
Open terminal voltage:	DC5.5V±1V
ON terminal current:	Approx. 7.5mA (at short-circuit), Approx. 5.0mA (at contact resistance of 250Ω)
Min. hold time:	200ms or more

● Current transformer input

Number of input points:	2 points
Input object:	Current transformer with 100 to 4,000 turns (availability is by 100-turn units) Optional unit Model No.: QN206A* (800 turns, hole diameter: 5.8 mm) Optional unit Model No.: QN212A* (800 turns, hole diameter: 12mm) * Not UL-certified.
Current measurement lower limit:	0.4Aac (800 turns, 1 time) Formula; Number of turns ÷ (2000 X number of power wire loops)
Current measurement upper limit:	50.0Aac (800 turns, 1 time) Formula; Number of turns ÷ (16 X number of power wire loops)
Allowable measured current:	70.0Aac (800 turns, 1 time) Formula; Number of turns ÷ (16 X number of power wire loops) X 1.4
Display range lower limit:	0.0Aac
Display range upper limit:	70.0Aac (800 turns, 1 time) Formula; Number of turns ÷ (16 X number of power wire loops) X 1.4
Display accuracy:	±5%FS
Display resolution:	0.1Aac

● **Control output**

• **Relay output**

Contact rating: NO side 250Vac/30Vdc, 3A (resistance load)
 NC side 250Vac/30Vdc, 1A (resistance load)

Life: 50,000 cycles or more on NO side
 100,000 cycles or more on NC side

Min. open/close specifications: 5V, 100mA

Min. open time/close times: 250ms

• **Motor relay output (model R1)**

Contact type: 1c (2 circuits: A contacts only)

Contact rating: 250Vac, 8A (resistive load)
 250Vac, 2A (cos ϕ = 0.4)
 24Vdc, 2.5A (L/R = 0.7ms)

Life: At least 120000 cycles (at the rated resistive load)
 At least 100000 cycles (at the rated inductive load)

Minimum requirements for switching: 24Vdc, 40mA

• **Voltage pulse output (For SSR drive)**

Voltage between terminals at open: 19Vdc \pm 15%

Internal resistance: 82 Ω \pm 0.5%

Allowable current: Max. 24mAdc (a higher current might cause output circuit failure)

OFF leak current: Max. 100 μ A

Min. OFF time/ON time: 1ms when the time proportional cycle time is less than 10s.
 250ms when the time proportional cycle time is more than 10s.

• **Current output**

Output type: 0 to 20mAdc or 4 to 20mAdc

Allowance load resistance: Max. 600 Ω

Output accuracy: \pm 0.1%FS (at an ambient temperature of 23 \pm 2 $^{\circ}$ C)
 However, \pm 1.0%FS in a range of 0 to 1mA.

Output resolution: 1/10000

• **Continuous voltage output**

Output type: 0 to 5Vdc, 1 to 5Vdc or 0 to 10Vdc

Allowable load resistance: Min. 1000 Ω

Output accuracy: \pm 0.1%FS (at an ambient temperature of 23 \pm 2 $^{\circ}$ C)
 However, \pm 1%FS at 0 to 0.05V.

Output resolution: 1/10000

● **Auxiliary output**

• **Current output**

Output type: 0 to 20mAdc or 4 to 20mAdc

Allowable load resistance: Max. 600 Ω

Output accuracy: \pm 0.1%FS (at an ambient temperature of 23 \pm 2 $^{\circ}$ C)
 However, \pm 1%FS at 0 to 1mA.

Output resolution: 1/10000

- **Continuous voltage output**

Output type:	0 to 5Vdc, 1 to 5Vdc or 0 to 10Vdc voltage output
Allowable load resistance:	Min. 1000Ω
Output accuracy:	±0.1%FS (at an ambient temperature of 23±2°C) However, ±1%FS at 0 to 0.05V.
Output resolution:	1/10000

- **Event relay output**

Number of output points:	2 to 3 points (This may vary depending on the model.)
Output type:	SPST contact 3 points, 3 points/common; 2 points, Each individual contact
Output rating:	250Vac/30Vdc, 2A (resistive load)
Life:	100,000 cycles or more
Min. open/close specifications:	5V, 10mA (Reference value)

- **RS-485 communication**

Transmission line:	3-wire method
Transmission speed:	4800, 9600, 19200, 38400 bps
Communication distance:	Max. 500m
Communication method:	Half duplex, start/stop synchronization method
Communication protocol:	In conformity with CPL and Modbus
Number of connection units:	Max. 31 units
Terminating resistor:	Connection prohibited.

- **Loader communication**

Transmission line:	3-wire method
Transmission speed:	Fixed at 19200 bps.
Recommended cable:	Included with the SLP-C35J50.

- **Isolation between input and output**

Portions enclosed by solid lines are insulated from other signals.

Portions enclosed by dotted lines are not insulated.

Power supply	Internal circuit	Control output 1
PV input		Control output 2
CT input 1		Auxiliary output
CT input 2		
MFB input		
Loader communication		
Digital input 1		Event output 1 *
Digital input 2		Event output 2 *
Digital input 3		Event output 3
Digital input 4		
RS-485 communication		
RSP input		

The inputs and outputs provided may vary depending upon the model.

* In case of the independent contacts, the output 1 and the output 2 are isolated.

● **Environment conditions**

• **Standard conditions**

Ambient temperature: 23±2°C
 Ambient humidity: 60±5%RH
 Power supply voltage: AC power model, 105Vac±1%, 50/60Hz±1Hz
 DC power model, 24Vac±1%, 50/60Hz±1Hz
 24Vdc±5%
 Vibration: 0m/s²
 Shock: 0m/s²
 Mounting angle: (Reference plane) ±3°

• **Operating conditions**

Ambient temperature: 0 to 50°C (0 to 40°C for gang-mounting)
 Ambient humidity: 10 to 90%RH (non-condensing)
 Rated power supply voltage: AC power model, 100 to 240Vac, 50/60Hz
 DC power model, 24Vac, 50/60Hz or 24Vdc
 Power supply voltage: AC power model, 85 to 264Vac, 50/60Hz±2Hz
 DC power model, 21.6 to 26.4Vac, 50/60±2Hz or 21.6 to 26.4Vdc
 Vibration: 0 to 2m/s² (10 to 60Hz for 2h in each of the X, Y, and Z-direction)
 Shock: 0 to 10m/s²
 Mounting angle: Reference plane (vertical) ±10°

• **Transportation conditions**

Ambient temperature: -20 to +70°C
 Ambient humidity: 10 to 95%RH (non-condensing)

● **Other specifications**

Power consumption: AC power model, Max. 12VA
 DC power model, Max. 12VA (24Vac), Max. 8W (24Vdc)
 Insulation resistance: Between power supply terminal and secondary terminal, 500Vdc, 20MΩ or more
 Dielectric strength: AC power model, Between power supply terminal and secondary terminal, 1500Vac for 1min.
 DC power model, Between power supply terminal and secondary terminal, 500Vac for 1min.
 Inrush current at power ON: AC power model, Max. 20A
 DC power model, Max. 20A
 Non-detected power failure time: Max.20ms (AC model)
 No power failure allowed (DC model)
 Altitude: 2000m or less
 Mass: C35 48 X 96 Approx. 250g (including mounting bracket)
 C36 96 X 96 Approx. 300g (including mounting bracket)
 Terminal screw tightening torque: 0.4 to 0.6N·m or less
 Standards compliance: EN61010-1,
 EN61326-1 (For use in industrial locations)
 During EMC testing, the reading or output may fluctuate by ±10 %FS.
 Over-voltage category: Category II (IEC60364-4-443, IEC60664-1)
 Allowable pollution degree: 2
 Console material: Polycarbonate
 Case material/color: Reformed PPE/Light gray (DIC650)

■ Accessories and optional parts

Name	Model No.
Mounting bracket	81409654-001 (Accessory)
Current transformer	QN206A* (800 turns, 5.8mm hole dia.)
	QN212A* (800 turns, 12mm hole dia.)
Hard cover	81446915-001 (for C35)
	81446916-001 (for C36)
Soft cover	81441121-001 (for C35)
	81441122-001 (for C36)
Terminal cover	81446912-001 (for C35)
	81446913-001 (for C36)
Smart Loader Package	SLP-C35J50

* Not UL-certified.

Appendix

Glossary

Abbreviations are used in the descriptions, tables, and figures in this manual. The following shows the main abbreviations:

AT	Auto Tuning
CT	Current Transformer
DI	Digital Input
DO	Digital Output (Control outputs of relay and voltage pulse, and event output)
EV	Event
LSP	Local Set Point. This value is the SP value stored in the instrument.
MFB	Motor Feed Back. This indicates the feed back of motor opening which is used for position proportional control.
MV	Manipulated Variable
PV	Process Variable
RSP	Remote Set Point. This is the set point which is set by the analog input from an external device.
SP	Set Point
U	Unit. This indicates the minimum digit of the selected PV input range with industrial unit (°C, Pa, L/min., etc.). 1U = 1°C in a range of -200 to +200°C. 1U = 0.1°C in a range of 0.0 to 200.0°C. Additionally, 1U = 0.01 when the DC voltage input is scaled to 0.00 to 10.00. Furthermore, 0.1U means 1/10 of 1U.

Index

-Number-	
3-wire system	4-5
5-wire system	4-6
-A-	
Accessories	1-3
Alarm code	10-2
Application example	5-80
Application layer	7-6, 7-3
AT Derivative time adjust	5-26
AT Integral time adjust	5-26
AT Proportional Band adjust	5-26
AT start	5-29
AT Stop/Start	5-11
AT type	5-26
Auto tuning (AT)	5-26, 5-29
AUTO/MANUAL mode	5-10
Auxiliary relay	4-3
-B-	
Bank selection display	2-3
Bank setup display	2-3
Basic configuration	2-1, 2-7
-C-	
C01 PV input range type	5-1
C02 Temperature unit	5-3
C03 Cold junction compensation (T/C)	5-3
C04 Decimal point position	5-5
C05 PV input range low limit	5-6
C06 PV input range high limit	5-6
C07 SP low limit	5-42
C08 SP high limit	5-42
C09 PV square root extraction dropout	5-4
C10 RSP input type	5-33
C11 RSP input range low limit	5-34
C12 RSP input range high limit	5-34
C14 Control action (Direct/Reverse)	5-15
C15 Output operation at PV alarm	5-15
C16 Output at PV alarm	5-15
C17 Output at READY	5-15
C18 Output at READY (Cool)	5-15
C19 Output operation at changing Auto/Manual	5-16
C20 Preset manual value	5-16
C21 Initial output type (mode) of PID control	5-16
C22 Initial output of PID control	5-17
C23 PID Decimal point position	5-17
C24 Zone PID operation	5-23
C26 Heat/Cool control	5-15
C27 Heat/Cool	5-24
C28 Heat/Cool control deadband	5-24
C29 Heat/Cool change point	5-24
C30 LSP system group	5-33, 5-43
C31 SP ramp type	5-33, 5-44
C32 SP ramp unit	5-38, 5-45
C33 STEP time unit	5-45
C34 STEP PV start	5-46
C35 STEP loop	5-47
C36 CT1 operation type	5-91
C37 CT1 output	5-91
C38 CT1 measurement wait time	5-91
C39 CT2 operation type	5-91
C40 CT2 output	5-91
C41 CT2 measurement wait time	5-91
C42 Output 1 range	5-87
C43 Output1 type	5-87
C44 Output 1 scaling low limit	5-88
C45 Output 1 scaling high limit	5-88
C46 Output 1 MV scaling	5-89
C47 Output 2 range	5-87
C48 Output 2 type	5-87
C49 Output 2 scaling low limit	5-88
C50 Output 2 scaling high limit	5-88
C51 Output 2 MV scaling	5-89
C52 AUX range type	5-87
C53 AUX type	5-87
C54 AUX Value at 0% output	5-88
C55 AUX Value at 100% output	5-88
C56 AUX MV scaling	5-89
C57 Position proportional type	5-109
C58 Position proportional deadband	5-111
C59 Motor long life mode	5-111
C60 Motor auto adjust	5-111
C61 Input with motor fully closed	5-115
C62 Input with motor fully open	5-115
C63 Motor full close-full open time	5-115
C64 CPL/Modbus	7-1
C65 Station address	7-1
C66 Transmission speed	7-1
C67 Data format (Data length)	7-1
C68 Data format (Parity)	7-1
C69 Data format (Stop bit)	7-1

C70 Response time-out	7-1
C71 Key operation mode/type	5-94
C72 [mode] key function	5-94
C73 MODE display setup	5-95
C74 PV/SP display setup	5-96
C75 MV display setup	5-97
C76 EV display setup	5-98
C77 Timer remain time display setup	5-98
C78 CT display setup	5-99
C79 User level	5-99
C80 Communication monitor display	5-99
C81 Multi Status (MS) display, Condition (top priority)	5-100
C82 Multi Status (MS) display, Status (top priority)	5-100
C83 Multi Status (MS) display, Condition (second priority)	5-100
C84 Multi Status (MS) display, Status (second priority)	5-100
C85 Multi Status (MS) display, Condition (third priority)	5-100
C86 Multi Status (MS) display, Status (third priority)	5-100
C87 Multi Status (MS) display, deviation range	5-100
C88 Special function	5-8
C89 Zener barrier adjustment	5-8
C90 Number of CT1 turns	5-92
C91 Number of CT1 power wire loops	5-92
C92 Number of CT2 turns	5-92
C93 Number of CT2 power wire loops	5-92
Calibration of current output/continuous voltage output	11-6
Calibration	11-1
Cap	1-4
CE marking	1-1
Checksum (LRC)	8-3
Checksum	7-4
Cold junction compensation (T/C)	5-1, 5-3
Command	
RD command	7-9
RS command	7-7
RU command	7-11
WD command	7-10
WS command	7-8
WU command	7-12

Communication data	9-1
Communication DI	5-11
Communication lock	5-107
Communication mode	7-1
Communication monitor display	5-99
Communication function	7-1
Communication procedures	7-2, 8-2
Connection of communication cable	4-5
Console display	5-94
Console	1-4, 1-5, 2-2
Constant current type	4-7
Continuous data read	7-7
Continuous data write	7-8
Continuous output	5-87
Continuous voltage output	5-86
Control action (Direct/Reverse)	5-15
Control algorithm	5-28
Control method	5-14
Controller alarm OR	5-67
CPL communication	7-1
CR filter	4-11
Crimp type terminal	4-4
Current transformer (CT) input	2-1, 5-89
CT display setup	5-99
CT input calibration	11-5
CT measurement wait time	5-91
CT operation type	5-89, 5-91
CT output	5-91
Current output	5-87
Current transformer input	2-1
Current transformer	1-3

-D-

Data Address	7-13, 8-11
Data format	7-1
Data link layer	7-3
Data setting procedures	2-4
Decimal point position	5-1, 5-5
Delay unit	5-67
Derivative time	5-19
Device ID code	7-3, 7-4
DI Assignment, Internal contact	5-37, 5-42
DI	2-1, 5-51
Differential (for ON/OFF control)	5-18
Digital input	2-1, 4-5
Display at power ON	2-3

DISPOSAL 12-1
DO 5-71

-E-

Energy saving 5-24
EV display setup 5-98
Event output 2-1
Event 5-58
 Alarm 5-64
 Control action (Direct) 5-64
 Deviation high limit 5-59
 Deviation high/low limit 5-59
 Deviation low limit 5-59
 During AT 5-64
 During SP ramp 5-64
 During estimated position control 5-64
 Heater 1 burnout 5-60
 Heater 1 short-circuit 5-60
 Heater 2 burnout 5-60
 Heater 2 short-circuit 5-60
 Invalid 5-64
 Loop diagnosis 5-61, 5-62, 5-63
 MANUAL 5-64
 MV high limit 5-60
 MV high/low limit 5-60
 MV low limit 5-60
 PV high limit 5-59
 PV high/low limit 5-59
 PV low limit 5-59
 READY 5-64
 RSP 5-64
 SP high limit 5-60
 SP high/low limit 5-60
 SP low limit 5-60
 Timer 5-64
External dimensions 3-2

-F-

Fixed length continuous data read 7-9
Fixed length continuous data write 7-10
Fixed length random data read 7-11
Fixed length random data write 7-12
Fuse replacement 10-1

-G-

Gain adjustment 11-3
Gang-mounting 3-2

-H-

Hard cover 1-3, 3-4
Heat/Cool change point 5-24
Heat/Cool control calculation 5-24
Heat/Cool control deadband 5-24
Heat/Cool control 5-15
Heat/Cool 5-24
High function configuration 2-7
Host device 7-1
Hysteresis 5-68

-I-

I/O check 11-2
IEC directive 1-1
Initial output of PID control 5-17
Initial output 5-19
Initialization 5-16
Input assign polarity 5-56
Input assign 5-55
Input bit function 5-51, 5-54
input types 1-1
Input with motor fully closed 5-115
Input with motor fully open 5-115
Installation place 3-1
Integration time 5-19
Internal contact operation type 5-52
Internal contact 5-51
Internal event No. definition 5-53
Internal Event Operation type 5-65
Internal Event 5-51
Isolation 13-4

-J-

Jack cover 1-4, 1-6
Just-FiTTER overshoot limit/restraint/control
 coefficient 5-28
Just-FiTTER settling band 5-28
Just-FiTTER 1-1, 5-28

-K-

Key lock 5-107
Key operation type 5-91

-L-

Latch 5-78

Line filter 4-11

Loader 1-4, 1-6

Loader lock 5-107

Loop 5-47

Lower display 1-4, 1-5

LSP group No. 5-36

LSP system group 5-33, 5-43

LSP 5-32, 5-33

LSP/RSP mode 5-10

-M-

Main setting 5-68

Maintenance 10-1

Manual reset 5-19

Master station 7-1

Message Structure 7-3, 8-3

MFB input 2-1

MFB 5-109

Modbus ASCII 8-3

Modbus communications 8-1

Modbus RTU 8-5

MODE display setup 5-95

Mode indicators 1-4, 1-6

[mode] key function 5-96

[mode] key operating procedures 2-7

Model selection table 1-2

Motor auto adjust 5-111

Motor drive relay output 4-3

Motor full close-full open time 5-115

Motor long life mode 5-111

Motor wiring 5-115

Mounting bracket 3-3

Mounting procedures 3-3

Multi Status (MS) display 1-4, 1-6, 5-100

Multi Status (MS) display, Condition 5-100

Multi Status (MS) display, Deviation graph 5-101

Multi Status (MS) display, Deviation OK 5-101

Multi Status (MS) display, Monitor 5-102

Multi Status (MS) display, MV graph 5-102

Multi Status (MS) display, Status 5-100

Multi-ramp 5-33, 5-40

MV display setup 5-97

MV high limit at AT 5-26

MV low limit at AT 5-26

MV process 5-72

MV scaling range 5-89

MV 5-19

-N-

Noise Preventive Measures 4-11

Number of connectable units 4-7, 4-8, 4-9

Number of CT turns and number of CT power wire loops 5-92

Number of steps 5-43

Numeric representation 7-14

-O-

OFF delay 5-69

ON delay 5-69

ON/OFF control point 5-18

ON/OFF control 5-14, 5-18

Operation display 2-3

Operation Modes 2-8

Operation type of internal contact 5-50

Optional parts 1-3

Output assign 5-75

Output at PV alarm 5-15

Output at READY 5-15

Output operation at changing Auto/Manual 5-16

Output operation at PV alarm 5-15

Output range 5-87

Output scaling 5-88

Output type 1-1, 5-87

Output 2-1

Over-voltage category 13-5

-P-

Password 5-108

Phase angle control 4-2

PID control initialization 5-16

PID control 5-19

PID decimal point position 5-19

PID fixed control 5-19

PID group No. for LSP 5-35

PID group No. for RSP 5-35

PID group No. 5-36

Polarity of function 5-56, 5-78

Polarity of output assign 5-76

Position proportional control 5-109

Position proportional deadband 5-110

Position proportional type 5-109

Preset MANUAL value	5-16
Proportional band	5-19
PV bias	5-6
PV filter	5-7
PV high limit alarm	5-7
PV high limit	5-7
PV hold	5-7
PV input calibration	
DC voltage/DC current input	11-3
PV input calibration (RTD input)	11-3
PV input calibration (thermocouple input)	11-3
PV input calibration	11-2
PV input failure	10-3
PV input range high limit	5-6
PV input range low limit	5-6
PV input range type	5-1, 5-2
PV input	2-1, 5-1
PV low limit alarm	5-7
PV low limit	5-7
PV range table	5-2
PV ratio	5-6
PV square root extraction	5-1
PV square root extraction dropout	5-4
PV start	5-46
PV/SP display setup	5-96

-R-

RAMP	5-43
Ramp-down	5-38
Ramp-up	5-38
RationalLOOP	1-1, 5-28
RD command	7-9
Read command (03H)	8-6, 8-7
Reception and transmission timing	7-16
Release all DO latches	5-11
Resistor type	4-7
Response monitor time	7-16
Response start conditions	7-3
RS command	7-7
RS-485 driver control timing	7-16
RSP bias	5-34
RSP filter	5-35
RSP high limit alarm	5-35
RSP high limit	5-35
RSP input calibration	11-4

RSP input	2-1
RSP low limit alarm	5-35
RSP low limit	5-35
RSP range high limit	5-34
RSP range low limit	5-34
RSP range	5-34
RSP ratio	5-34
RSP	5-32, 5-35
RTD	5-1, 5-2
RU command	7-11
RUN/READY mode	5-10

-S-

Sample program	7-17, 7-18
Sampling cycle	13-1
Scaling	5-1
Sensor type	5-2
SOAK	5-43
Soft cover	1-3, 3-5
SP high limit	5-42
SP lag	5-28
SP low limit	5-42
SP multi-ramp	5-40
SP ramp disabled	5-42
SP ramp enabled	5-42
SP ramp type	5-33, 5-44
SP ramp unit	5-38, 5-45
SP ramp-down	5-38
SP ramp-up	5-38
SP	5-32
Special function	5-8
Special OFF setup	5-67
Special type	2-5
SSR	4-7
Stand-alone mounting	3-3
Standard ramp	5-33
Standard setup	2-7
Standard type	2-4
Standby	5-66
Station address	7-1, 7-4
Step hold status	5-50
STEP loop	5-47
STEP operation	5-43
STEP PV start	5-46
STEP time unit	5-45
Sub setting	5-68
Sub-address	7-3, 7-4

-T-

Temperature unit	5-1, 5-3
Terminal assignment label	4-2
Terminal cover	1-3, 4-2
Terminal part	1-7
Terminating resistor	4-2, 4-5, 4-6
Termination code	7-15
Thermocouple	5-1
Tightening torque	4-2, 13-5
Time proportional cycle mode	5-72
Time proportional cycle	5-72
Timer remaining time display setup	5-98
Transition	2-8
Transmission speed	7-1
Transmission start time	7-16
Tree structure	2-2

-U-

Upper display	1-4, 1-5
User function	5-103
User level	2-7, 5-99

-V-

Voltage between terminals	4-7, 4-8, 4-9
-------------------------------------	---------------

-W-

WD command	7-10
Wiring resistance	5-9
Write command (10H)	8-9, 8-6
Writing conditions	7-13
Writing data range	7-13
WS command	7-8
WU command	7-12

-Z-

Zener barrier adjustment	5-8
Zone PID	5-23

Revision History

Printed Date	Manual Number	Edition	Revised pages	Description
Feb. 2004	CP-UM-1150E	1st Edition		
Oct. 2004		2nd Edition	1-2, 4-3, 13-5 1-7, 13-5 4-9 4-10 5-59 5-86 5-104 5-106 6-14 13-1	DC power model added. The tightening torque of the terminal screw changed. 0.4N•m or less→0.4 to 0.6 N•m or less. Resistor type SSR added. ■Connection method for the motor drive relay output(R1) added. Note about CT1/2 heater burnout/over-current and short-circuit added. Contents about unit added in the table. Setting 0 and an explanation added in the table. Handling Precautions added. Handling Precautions added. Remarks about C42 to C45 added. A standard of temperature sensor about input type added.
May 2005		3rd Edition	3-4 5-2 5-5 5-13 5-18 5-23 5-24 5-25 5-38 5-51 5-62 5-63 5-85 5-87 5-88, 5-89 5-90, 5-91 5-92 to 5-113 6-14, 6-15 6-18 6-19 7-3 to 7-5 9-2, 9-3 10-2 10-3 to 10-4 13-1 13-3 13-5 to 13-7 13-6	■Mounting procedures 2nd contents changed. ●PV input range table *1,*2 added. Handling Precautions explanation added. MV rate-change limit (Setting: Parameter oUTL) added. ■Output variation limit added. Priorities for PID group change added. Hysteresis for zone added. Change point→50.0% changed. ■SP ramp-up/ramp-down,explanation item added. ■Event channel definitions Contents changed. High and Low limits of MFB value added. Note *1 added. Handling Precautions added. ■Output type Contents No. 10,11 added. explanation 2 item. ■MV scaling range added. Old 5-87 to 5-89 pages. ■Number of CT turns and number of CT power wire loops added. Old 5-89 to 5-110 pages. C46, 51, 56 added. Handling Precautions added. C90 to 93 added. Handling Precautions added. Display E1.C1 Contents 33 added. Handling Precautions added. Device ID code changed to Device code. Control output 1, 2 and Auxiliary output 3 MV scaling added. ■Alarm displays and corrective action AL11 added. Handling Precautions added. Old 10-2 to 10-3 pages. A standard of temperature sensor about input type added. DC voltage input Input impedance added. ●Current transformer input changed. Old 13-4 to 13-6 pages. Non-detected power failure time added.
Sep. 2005		4th Edition	4-5 4-7 5-73 6-10 13-1	Digital input circuit diagram changed. ●Constant current type added. Contents 44 (AL01 to AL99) added. Contents 45 (AL01 to AL03) added. Display CYU, CY2 Remarks changed. Diameter of the applicable thermocouple or compensating wire added.

Printed date	Manual Number	Edition	Revised pages	Description
Feb. 2006	CP-SP-1150E	5th Edition	5-1 5-2 5-5 5-8 5-105 13-2	Manual name changed. ■PV input range type: this item transferred from page 5-2. PV range tables totally changed. Explanation changed in the first item of Handling Precautions. Explanation changed. ●Adjusting procedures (1), table: Applicable PV range type changed for Wiring status 1. Note added to the section on key lock, communications lock, and loader lock. ●DC current input: "Allowable input current: Max. 30mA" added.
June 2006		6th Edition	v 4-11 5-2 5-39 5-64 5-97 5-101 6-4 6-17	Manual name changed. Section 4-2 Recommended Cables added. ●PV input range table (Thermocouple) and ●PV input range table (RTD): range (Fahrenheit) added. ■PV multi-ramp table: user level item high function to standard changed. Table added in the two item of Handling Precautions. ■User level table: Initial value item 0 to 1 changed. ■User Function bank: explanation added. rmP.1 to rmP.8 user level item: 2 to 1 changed, tIm.1 to tIm.8 user level item: 2 to 1 changed. C79 user level item: 0 to 1 changed.
Nov. 2006		7th Edition	1-3 3-1 to 3-4 3-5 5-49 5-51 5-85 6-30 13-6 13-7	Soft cover added. Layout changed. Old 3-1 to 3-6 page. ●Using a soft cover: this item was added. Flow chart for "Input bit function is not used": polarity added. Set value No.8: "(Note 1)" deleted. Set value No.7: "(Note 1)" added. Contents No.6 of ■Out type: "(PV-SP)" added. Contents of ROM ID: 2fixed. Applicable standards: EN61326-1 changed to EN61326. Soft cover added.
Mar. 2007		8th Edition	1-1 5-26 5-31, 5-107 13-2	Various clarifications. Standards compliance: EN61326-1 changed to EN61326. Note of AT derivative time adjustment coefficient: added. Initial value of At-d: changed. Item 1 added. Input impedance of DC voltage input: 1MΩ changed to Min. 1MΩ.
Apr. 2007		9th Edition	5-99	Lighting range of deviation graph: -100.1% or less changed to -100.0% or less.
Jan. 2008		10th Edition	v, vi D-1 to D-8 5-2 5-9 9-11 13-2	Description on SDC35/36 Quick Reference Guide added. SDC35/36 Quick Reference Guide added. Note *3,*4 added. 2nd item of Handling Precautions changed. Remarks of item input alarm status: Description added. Allowable input voltage added.

Printed Date	Manual Number	Edition	Revised pages	Description
Aug. 2008	CP-SP-1150E	11th Edition	v 13-1 13-2	Manual No. CP-UM-5289E to CP-UM-5289JE changed. Sampling cycle time 0.1s to 100ms changed. Input impedance of voltage input specifications: Max. 1M Ω to min. 1M Ω changed. Current input specifications: Allowable input current and allowable input voltage added.
June 2009		12th Edition	End paper i, 1-1, 13-6 D-6 2-3 3-1 4-10 4-12 5-34, 5-35 5-37 5-38 5-39 5-107 6-10 7-5 7-6 7-7 to 7-18 7-17 7-18 13-1, 13-2 End of book	RESTRICTIONS ON USE deleted. Standards compliance: "EN61326" changed to "EN61326-1." Parameter bank note *1 was changed. Description of key operation corrected. Installation locations: item added. "Connection with current-input type controllers" section added. "Noise preventive measures" section was moved to page 4-11. Old page 4-11. "RSP ratio and RSP bias" and "RSP filter" sections: "Standard" was added to the User level. "SP ramp unit" section was moved to page 5-38. SP ramp-up/ramp-down: Explanation added. SP multi-ramp: "High function" was added to the User level. "Modutrol motor" was changed to "motor." User level for RSP filter and RSP bias: "0" changed to "1." Command details were added to the sample message. "Application layer" section was moved from page 7-5. Old page 7-6 to 7-16. "Compiling" section added. "Running the sample program" section added. "Processing of the sample program" sections were moved from page 7-17. • Thermocouple (T/C) input, • Resistance temperature detector (RTD) input and • DC voltage input: Allowable input voltage were added. Terms and Conditions added.
Nov. 2010		13th Edition	iii 2-3 4-1 5-26 5-110 13-4	2nd WARNING: Explanation changed. Figure was changed. 1st WARNING: Explanation changed. AT type: Initial value changed from 0 to 1. 3rd motor auto adjusting procedure: 4th item partly deleted. 4th motor auto adjusting procedure: Description added to 3rd item • Motor drive relay output (R1 model): Description added to contact type • Voltage pulse output (For SSR drive): Description added to allowable current

Printed Date	Manual Number	Edition	Revised pages	Description
June 2011	CP-SP-1150E	14th Edition	5-39, 5-40, 5-49 5-40 to 5-115	Handling Precautions added. Old page 5-39 to 5-113
Apr. 2012		15th Edition		Company name changed.
Aug. 2012		16th Edition	5-45 6-11 10-3	The initial value of AT type was changed from 1 to 0. Handling precautions for STEP time unit were added. Range Nos. 81, 82, and 83: "Downscale (-10, %FS), AL02" was changed to "Upscale (110 %FS), AL02."
Jan. 2013		17th Edition	4-3 13-4	■ Wiring precautions changed. • Motor relay output (model R1) changed.
Nov. 2013		18th Edition	i, 1-3 1-2 1-4 3-1 4-2, 4-3 4-11 5-2 5-8 5-9 5-24, 5-25 13-1 End of the manual	Specifications of common mode voltage to ground were changed. Model selection table was changed. Note 4 was added. Descriptions for figures were added. A location was added to "Installation place." Wiring Precautions were changed. "Wiring with zener barriers" section was added. Handling Precaution was added. Descriptions were changed in "Zener barrier adjustment" section. Handling Precautions were changed and added. "Heat/cool output" section was added. A note was added to the specifications for PV input. Terms and Conditions were changed (to version No. AA511A-014-03).
Mar. 2014		19th Edition	1-3, 13-3, 13-7 4-11	A note was added to the specifications for current transformer input. Azbil Corporation's line filter model No. was changed.
Nov. 2014		20th Edition	Cover iii, 4-1 1-2 6-13 End of the manual	A notice saying "Not for use in Japan" was added. Caution was changed. Table of "■ Model selection table" changed. Table of "■ Setup bank" changed. Terms and Conditions were changed (to version No. AA511A-014-04).
Oct. 2016		21st Edition	i, 10-1 i i, 13-6 D-3, D-6, 6-12, 9-2 D-3, D-7, 5-6, 6-18, 9-3 1-2 5-3 13-5 End of the manual	The 500 mA rated current was rewritten as 0.5 A. Installation location and Altitude were added. STANDARDS COMPLIANCE was changed. C13 was added. C97 was added. The model selection table was changed. Table note of "■ PV input range type" changed. The description of the loader cable specification was changed. Terms and Conditions were changed (to version No. AA511A-014-09).

Terms and Conditions

We would like to express our appreciation for your purchase and use of Azbil Corporation's products. You are required to acknowledge and agree upon the following terms and conditions for your purchase of Azbil Corporation's products (system products, field instruments, control valves, and control products), unless otherwise stated in any separate document, including, without limitation, estimation sheets, written agreements, catalogs, specifications and instruction manuals.

1. Warranty period and warranty scope

1.1 Warranty period

Azbil Corporation's products shall be warranted for one (1) year from the date of your purchase of the said products or the delivery of the said products to a place designated by you.

1.2 Warranty scope

In the event that Azbil Corporation's product has any failure attributable to azbil during the aforementioned warranty period, Azbil Corporation shall, without charge, deliver a replacement for the said product to the place where you purchased, or repair the said product and deliver it to the aforementioned place.

Notwithstanding the foregoing, any failure falling under one of the following shall not be covered under this warranty:

- (1) Failure caused by your improper use of azbil product (noncompliance with conditions, environment of use, precautions, etc. set forth in catalogs, specifications, instruction manuals, etc.);
- (2) Failure caused for other reasons than Azbil Corporation's product;
- (3) Failure caused by any modification or repair made by any person other than Azbil Corporation or Azbil Corporation's subcontractors;
- (4) Failure caused by your use of Azbil Corporation's product in a manner not conforming to the intended usage of that product;
- (5) Failure that the state-of-the-art at the time of Azbil Corporation's shipment did not allow Azbil Corporation to predict; or
- (6) Failure that arose from any reason not attributable to Azbil Corporation, including, without limitation, acts of God, disasters, and actions taken by a third party.

Please note that the term "warranty" as used herein refers to equipment-only-warranty, and Azbil Corporation shall not be liable for any damages, including direct, indirect, special, incidental or consequential damages in connection with or arising out of Azbil Corporation's products.

2. Ascertainment of suitability

You are required to ascertain the suitability of Azbil Corporation's product in case of your use of the same with your machinery, equipment, etc. (hereinafter referred to as "Equipment") on your own responsibility, taking the following matters into consideration:

- (1) Regulations and standards or laws that your Equipment is to comply with.
- (2) Examples of application described in any documents provided by Azbil Corporation are for your reference purpose only, and you are required to check the functions and safety of your Equipment prior to your use.
- (3) Measures to be taken to secure the required level of the reliability and safety of your Equipment in your use

Although azbil is constantly making efforts to improve the quality and reliability of Azbil Corporation's products, there exists a possibility that parts and machinery may break down.

You are required to provide your Equipment with safety design such as fool-proof design, *1 and fail-safe design*2 (anti-flame propagation design, etc.), whereby preventing any occurrence of physical injuries, fires, significant damage, and so forth. Furthermore, fault avoidance,*3 fault tolerance,*4 or the like should be incorporated so that the said Equipment can satisfy the level of reliability and safety required for your use.

*1. A design that is safe even if the user makes an error.

*2. A design that is safe even if the device fails.

*3. Avoidance of device failure by using highly reliable components, etc.

*4. The use of redundancy.

3. Precautions and restrictions on application

Azbil Corporation's products other than those explicitly specified as applicable (e.g. azbil Limit Switch For Nuclear Energy) shall not be used in a nuclear energy controlled area (radiation controlled area).

Any Azbil Corporation's products shall not be used for/with medical equipment.

The products are for industrial use. Do not allow general consumers to install or use any Azbil Corporation's product.

However, azbil products can be incorporated into products used by general consumers. If you intend to use a product for that purpose, please contact one of our sales representatives.

In addition,

you are required to conduct a consultation with our sales representative and understand detail specifications, cautions for operation, and so forth by reference to catalogs, specifications, instruction manual, etc. in case that you intend to use azbil product for any purposes specified in (1) through (6) below.

Moreover, you are required to provide your Equipment with fool-proof design, fail-safe design, anti-flame propagation design, fault avoidance, fault tolerance, and other kinds of protection/safety circuit design on your own responsibility to ensure reliability and safety, whereby preventing problems caused by failure or nonconformity.

- (1) For use under such conditions or in such environments as not stated in technical documents, including catalogs, specification, and instruction manuals
- (2) For use of specific purposes, such as:
 - * Nuclear energy/radiation related facilities
[For use outside nuclear energy controlled areas] [For use of Azbil Corporation's Limit Switch For Nuclear Energy]
 - * Machinery or equipment for space/sea bottom
 - * Transportation equipment
[Railway, aircraft, vessels, vehicle equipment, etc.]
 - * Antidisaster/crime-prevention equipment

- * Burning appliances
 - * Electrothermal equipment
 - * Amusement facilities
 - * Facilities/applications associated directly with billing
- (3) Supply systems such as electricity/gas/water supply systems, large-scale communication systems, and traffic/air traffic control systems requiring high reliability
 - (4) Facilities that are to comply with regulations of governmental/public agencies or specific industries
 - (5) Machinery or equipment that may affect human lives, human bodies or properties
 - (6) Other machinery or equipment equivalent to those set forth in items (1) to (5) above which require high reliability and safety
4. Precautions against long-term use

Use of Azbil Corporation's products, including switches, which contain electronic components, over a prolonged period may degrade insulation or increase contact-resistance and may result in heat generation or any other similar problem causing such product or switch to develop safety hazards such as smoking, ignition, and electrification. Although acceleration of the above situation varies depending on the conditions or environment of use of the products, you are required not to use any Azbil Corporation's products for a period exceeding ten (10) years unless otherwise stated in specifications or instruction manuals.
 5. Recommendation for renewal

Mechanical components, such as relays and switches, used for Azbil Corporation's products will reach the end of their life due to wear by repetitious open/close operations. In addition, electronic components such as electrolytic capacitors will reach the end of their life due to aged deterioration based on the conditions or environment in which such electronic components are used. Although acceleration of the above situation varies depending on the conditions or environment of use, the number of open/close operations of relays, etc. as prescribed in specifications or instruction manuals, or depending on the design margin of your machine or equipment, you are required to renew any Azbil Corporation's products every 5 to 10 years unless otherwise specified in specifications or instruction manuals. System products, field instruments (sensors such as pressure/flow/level sensors, regulating valves, etc.) will reach the end of their life due to aged deterioration of parts. For those parts that will reach the end of their life due to aged deterioration, recommended replacement cycles are prescribed. You are required to replace parts based on such recommended replacement cycles.
 6. Other precautions

Prior to your use of Azbil Corporation's products, you are required to understand and comply with specifications (e.g., conditions and environment of use), precautions, warnings/cautions/notices as set forth in the technical documents prepared for individual Azbil Corporation's products, such as catalogs, specifications, and instruction manuals to ensure the quality, reliability, and safety of those products.
 7. Changes to specifications

Please note that the descriptions contained in any documents provided by azbil are subject to change without notice for improvement or for any other reason. For inquires or information on specifications as you may need to check, please contact our branch offices or sales offices, or your local sales agents.
 8. Discontinuance of the supply of products/parts

Please note that the production of any Azbil Corporation's product may be discontinued without notice. For repairable products, we will, in principle, undertake repairs for five (5) years after the discontinuance of those products. In some cases, however, we cannot undertake such repairs for reasons, such as the absence of repair parts. For system products, field instruments, we may not be able to undertake parts replacement for similar reasons.
 9. Scope of services

Prices of Azbil Corporation's products do not include any charges for services such as engineer dispatch service. Accordingly, a separate fee will be charged in any of the following cases:

 - (1) Installation, adjustment, guidance, and attendance at a test run
 - (2) Maintenance, inspection, adjustment, and repair
 - (3) Technical guidance and technical education
 - (4) Special test or special inspection of a product under the conditions specified by you

Please note that we cannot provide any services as set forth above in a nuclear energy controlled area (radiation controlled area) or at a place where the level of exposure to radiation is equivalent to that in a nuclear energy controlled area.

azbil

Azbil Corporation
Advanced Automation Company

1-12-2 Kawana, Fujisawa
Kanagawa 251-8522 Japan

URL: <http://www.azbil.com>

Specifications are subject to change without notice. (09)

1st edition: Feb. 2004
21st edition: Oct. 2016 (F)