

BC-R35 Series Burner Controller User's Manual



Thank you for purchasing BC-R35 Series. This manual contains information for ensuring the correct use of BC-R35 Series

This manual should be read by those who design and maintain equipment that uses BC-R35 Series.

It also provides necessary information for installation, maintenance, and troubleshooting. Be sure to keep this manual nearby for handy reference.

NOTICE

Be sure that the user receives this manual before the product is used.



Copying or duplicating this user's manual in part or in whole is forbidden. The information and specifications in this manual are subject to change without notice.

Considerable effort has been made to ensure that this manual is free from inaccuracies and omissions. If you should find an error or omission, please contact Azbil Corporation.

In no event is Azbil Corporation liable to anyone for any indirect, special or consequential damages as a result of using this product.

Conventions Used in This Manual

- To prevent injury to the operator and others, and to prevent property damage, the following types of safety precautions are indicated:

 WARNING	Warnings are indicated when mishandling this product might result in death or serious injury.
 CAUTION	Cautions are indicated when mishandling this product might result in minor injury to the user, or physical damage to the product.

- In describing the product, this manual uses the icons and conventions listed below.



Use caution when handling the product.



The indicated action is prohibited.



Be sure to follow the indicated instructions.



Handling Precautions:

Handling Precautions indicate items that the user should pay attention to when handling this module.



Note:

Notes indicate information that might benefit the user.















This indicates the item or page that the user is requested to refer to.

(1)(2)(3)





Numbers within parentheses indicate steps in a sequence or parts of an explanation.

Safety Precautions

WARNING

	Use this device with combustion equipment that is started and stopped at least once in a 24-hour period.
	This device cannot be used with combustion equipment that operates continuously for 24 hours or longer.
	Before removing, mounting, or wiring the BC-R35 Series, be sure to turn off the power to the BC-R35 Series and all connected devices. Failure to do so might cause electric shock.
	If lockout occurs, reset it only after removing the cause. Also, do not enter reset input repeatedly. Operating this product improperly could result in a serious combustion equipment accident.
	Never input a reset command from a remote location. Because it is difficult to make a safety check when far from the equipment, there is an increased risk of explosion.
	This device is equipped with functions that are extremely important for the safe operation of combustion equipment. Be sure to follow the instructions given in this manual.
	Check the model number carefully and check that the sequence timing is as specified by the combustion equipment manufacturer. Installing the wrong model can result in an explosion hazard.
	Do not touch terminal 14 (F) immediately after the power has been turned off. Because the terminal retains an electrical charge, there is a danger of electric shock.
	Do not use the monitor output or alarm relay output as safety output.
	This device has an operating life and should be replaced within that time. Continued use beyond the lifespan may result in device failure.
	Do not start regular operation of the equipment without first completing the adjustments and tests for this device, as well as the tests specified by the equipment manufacturer.
	Do not disassemble this device. Malfunction, device failure, or electric shock may result.

CAUTION

	In order to use this product correctly, be sure to follow this manual, the manuals for any associated devices, and the manuals for the combustion equipment. When designing a flame safeguard control system, please consult with a representative of the azbil Group.
	Installation, wiring, inspection, adjustment, maintenance, etc. should be carried out only by trained and experienced technicians who have knowledge and technical skills related to this product and associated equipment.
	Be sure to use this device correctly, within the ranges specified in this user's manual. Otherwise device failure or malfunction could result.
	Avoid installing the device where it will be subject to conditions such as the following. Otherwise device failure could result. <ul style="list-style-type: none">• Certain chemicals or corrosive gases• High temperatures• Splashing water or excessive humidity.• Prolonged vibration
	Wire this device in compliance with established norms, using the types of wire and wiring methods specified in this manual. Otherwise there is a risk of device failure or malfunction.

CAUTION



Carry out maintenance and inspection correctly according to the methods, procedures, replacement cycles, etc., specified in this manual.



When discarding this product, dispose of it as industrial waste, following local regulations.



Do not connect a load that exceeds the rating stated in the specifications to the control load terminals (terminals 2-1, 2-6, 2-7, or 2-8), and do not short-circuit the load. Doing so will burn out the internal fuse, making the device unusable. To comply with CE standards, it is necessary to take measures to prevent the use of a device whose relay contacts can be damaged by a connected load that exceeds the rating or by a load short-circuit. For this reason, this device uses an internal fuse that cannot be replaced.

Contents

Conventions Used in This Manual Safety Precautions

Chapter 1. Overview

■ Instructions for proper use	1
■ Precautions on facility design	1
■ Most important points in ensuring safety	2
■ Model number	3
■ Related equipment	5

Chapter 2. Installation, Wiring

■ Installation method	7
■ Cautions regarding installation	8
■ Installation orientation	8
■ DIN rail mounting	8
■ Mounting in a Panel	9
■ Mounting / removing the device and sub-base (sold separately)	9
■ Terminal numbers, front panel item names	10
■ Example of wiring connection with external device	12

Chapter 3. Operation

■ Names of parts	17
■ Operation	17
■ Trial operation mode	19
■ Function setting mode (for POC and host communications (RS-485) address)	21
■ Host communication settings using the Smart Loader Package (SLP-BCR)	23

Chapter 4. Explanation of Operation

■ Example of wiring connection with external device	24
■ Operation Sequence	27
■ Alarm and occurrence sequence	52

Chapter 5. Trial Operation and Adjustment

■ Preliminary inspection	53
■ Inspection procedure	53
■ Control motor adjustment, air pressure switch adjustment	54
■ Ignition spark response (UV sensor)	55
■ Measurement of flame voltage	56
■ Pilot turn-down test	58
■ Safety shutoff check	59

Chapter 6. Maintenance and Inspection

- **General maintenance and inspection 60**
- **Maintenance and inspection cycle 60**
- **Alarm codes and details 61**
- **Failure inspection flow 62**

Chapter 7. Specifications

- **External dimensions 65**

Chapter 1. Overview

BC-R35 series burner controllers are designed exclusively for batch operation of combustion equipment (at least one start and stop in a 24-hour period). These combustion safety controllers automatically and safely execute ignition, flame monitoring, and fuel shutoff for proportional control oil burners and gas burners. In addition, they are equipped with a 7-segment display that can be used during maintenance, and a trial-run mode which is useful for test runs and making adjustments. The BC-R35 also features host communications (RS-485) and Smart Loader Package functions to provide more detailed status monitoring and troubleshooting.

- 7-segment display for sequence codes and alarm codes.
- LED indicators show whether there is a flame signal and whether lock-out is present.
- The monitor outputs the operating status of the flame signal, no ignition, flame failure and lock-out interlock.
- Perform fault diagnosis for the internal control relay circuit.
- The product is designed so that it cannot be restarted in the case of lock-out due to no ignition, false flame or other causes, unless it is reset manually.
- The design complies with JIS C 9730-2-5 and JIS C 9730-1.
- The air-flow switch (OFF/ON) is checked before and after startup. (JIS B 8407)
- POC (proof of closure) function based on shutoff valve closure confirmation switch input.
- Host communication (RS-485) allowing remote observation of status.
- DIN rail mounting and sub-base structure are provided for easy installation and replacement
- Three-position control or proportional control of combustion.
- Models with low-fire stop function are available.

■ Instructions for proper use

- This device has functions that are extremely important for the safe operation of combustion equipment. Therefore, use the device correctly, according to this user's manual.
- The device must be installed, wired, maintained, inspected and adjusted by experienced specialists who have gained knowledge and skills concerning combustion equipment and combustion safety devices.

■ Precautions on facility design

The facilities that use the combustion safety device must be designed taking into careful consideration the following safety guidelines and the like.

If the system is designed to a foreign specification, refer to laws and standards in the relevant country.

- "Technical Policy on Safety Standards for Combustion Equipment in Industrial Furnaces" by the Ministry of Health, Labour and Welfare
- "Combustion Equipment in Compliance with the Safety Principles for Industrial Incinerators" - JIS B 8415
- "Forced Draught Burners - Part 1: Gas Burners" - JIS B 8407-1
- "Forced Draught Burners - Part 2: Oil Burners" - JIS B 8407-2
- "Index of Safety Technology of Industrial Gas Combustion Equipment," by Japan Gas Association
- "Index of Safety Technology of Gas Boiler Combustion Facilities," by Japan Gas Association
- Absorption Chiller/Heater Safety Standards," by Japan Refrigeration and Air Conditioning Industry Association

■ **Most important points in ensuring safety**

The design must take into consideration the following points to ensure safety.

1. Connect the load directly to the device.
2. Make sure that the start check circuit operates correctly at startup.
3. Do not make a manual operation circuit or other bypass circuit for any loads.
4. Use a redundant shutdown system for both main valve and pilot valve.

■ Model number

(Note: The dedicated sub-base and sideboard are not provided with the BC-R35 series controller. Order them separately.)

● Flame detector: Flame rod / UV sensor (AUD100/110)

I II III IV V VI VII Example: **BC-R35B1G0500**

I	II	III	IV	V	VI	VII	Description
Base model number	Communications functions	Combustion sensor	Power supply	Function code	Timing Code	Additional functions	
BC-R							Burner Controller
	35						Host communications (RS-485)/Smart Loader Package function
		B					Flame rod (Ionization)
		C					UV sensor (AUD100/110)
			1				100 Vac
			2				200 Vac
			6				220 Vac
				G			Interrupted pilot type (without low fire shutdown)
				J			Interrupted pilot type (with low fire shutdown)
				L			Direct ignition type (without low fire shutdown)
				N			Direct ignition type (without low fire shutdown)
					050		Pre-purge time 35 s
					086		Pre-purge time 45 s
					122		Pre-purge time 60 s
					158		Pre-purge time 3 min
						0	None
						D	Inspection record (with data)

● Flame detector: Visible light flame detector AFD100/110 series

I II III IV V VI VII Example: **BC-R35A7G0500**

I	II	III	IV	V	VI	VII	Description
Base model number	Communications functions	Combustion sensor	Power supply	Function code	Timing Code	Additional functions	
BC-R							Burner Controller
	35						Host communications (RS-485)/Smart Loader Package function
		A					Visible light flame detector
			7				100-230 Vac
				G			Interrupted pilot type (without low fire shutdown)
				L			Direct ignition type (without low fire shutdown)
					050		Pre-purge time 35 s
						0	None
						D	Inspection record (with data)

● Flame detector: Contact input

I II III IV V VI VII Example: **BC-R35F7G0490**

I	II	III	IV	V	VI	VII	Description
Base model number	Communi-cations functions	Combustion sensor	Power supply	Function code	Timing Code	Additional functions	
BC-R							Burner Controller
	35						Host communications (RS-485)/Smart Loader Package function
		F					Contact input
			7				100-230 Vac
				G			Interrupted pilot type (without low fire shutdown)
				L			Direct ignition type (without low fire shutdown)
					049		Pre-purge time 35 s, Flame response timing 1 s max
					121		Pre-purge time 60 s, Flame response timing 1 s max
						0	None
						D	Inspection record (with data)

■ Related equipment

● Compatible flame detector (sold separately)

- UV sensor

Model number	Name	Notes
AUD15C1000	Advanced UV sensor tube device	Use a dedicated socket for the AUD100C/110C/120C
AUD100C100 _	Dedicated socket for the AUD15	AUD15C1000, sold separately
AUD100C1000-A15	Lead wire type	AUD15C1000 in package
AUD110C100 _	Dedicated socket for the AUD15	AUD15C1000, sold separately
AUD110C1000-A15	Terminal board type	AUD15C1000 in package
AUD120C120 _	Dedicated socket for the AUD15	Without G1/2 adapter, AUD15C1000, sold separately
AUD120C121 _	1/2-inch mounting type	With G1/2 adapter, AUD15C1000, sold separately

_ : 0: standard product. D: with inspection record (with data).

T: tropicalization (AUD110C only).

B: inspection record (with data) and tropicalization (AUD110C only).

- Flame rod

Model number	Name	Notes
C7007A	Flame rod holder	
C7008A	Flame rod assembly	

- Visible light flame detector





Model number	Name	Notes
AFD100A0700	Visible light flame detector	Light reception direction: front, top-view type
AFD100B0700		Light reception direction: side, side-view type
AFD110A0000		G3/4-inch flange mounting type

● Options (sold separately)

Model number	Product name	Notes
BC-R05A100	Dedicated sub-base for BC-R	Required for all products in the BC-R30 series
81447514-001	Connector for front wiring	Contains one Weidmueller model number : BL3.5/11F Compatible wire: 0.2-1.5 mm ² (28-14 AWG)
81447514-002	Connector for front wiring (for right-side wiring)	Contains one Weidmueller model number : BL3.5/11/270F Compatible wire: 0.2-1.5 mm ² (28-14 AWG)
81447515-001	Side boards (2)	Contains two Not included in the sub-base
SLP-BCRJ71	Smart Loader Package (no cable)	Compatible with BC-R35 (with communications functions)
81441177-001	USB loader cable	
FSP136A100	Analog flame meter	
81447519-001	Jack cover	Contains one
81447531-001	Front connector cover	Mounting screw supplied

Chapter 2. Installation, Wiring

WARNING

-  Never input a reset command from a remote location. Because it is difficult to make a safety check when far from the equipment, there is an increased risk of explosion.
-  This device is equipped with functions that are extremely important for the safe operation of combustion equipment. Be sure to follow the instructions given in this manual.
-  Check the model number carefully and check that the sequence timing is as specified by the combustion equipment manufacturer. Installing the wrong model can result in an explosion hazard.
-  Connect loads (ignition transformer, solenoid valve, etc.) directly to the output terminals of this device. Combustion safety cannot be assured without a direct connection.

CAUTION

-  A ground-fault detection circuit is included in this device. Even if the power supply does not have high and low potential sides, if a ground fault occurs due to insulation failure of a load such as an ignition transformer, pilot valve, or main valve, this device will detect the ground fault and safely shut off and lock out the equipment.
-  When mounting and wiring, be sure to follow this user's manual or the instruction manuals provided by the equipment or system manufacturer.
-  Carry out the wiring work in conformity with the specified standards.
-  Connect the power supply last to prevent electric shock or damage. Otherwise touching terminals by mistake may cause electric shock or may damage the device.
-  Make sure that loads connected to the terminals do not exceed the rating indicated in the specifications.
-  Supply power at the voltage and frequency indicated on the model number label of the device.
-  In keeping with technical standards for electrical equipment, the burner frame must be connected to an earth ground by a wire having a resistance of less than 100 Ω .
-  Run the high-voltage ignition transformer cable separately and keep it at least 30 cm away from this device.
-  Keep power lines and ignition transformer high-voltage cables separate from the flame detector wires.
-  Make sure that ignition transformer high-voltage cables are properly connected to prevent faulty contact. Faulty contact can generate high-frequency radio waves, causing malfunction.
-  The ignition transformer ground lead should be connected directly to the burner itself or to a metallic part electrically connected to the burner.
-  Be sure to check that the wiring is correct before you turn the power ON. Incorrect wiring can cause damage or malfunction.
-  If the wires from this device exceed the recommended length, to prevent malfunction due to external electrical noise, keep power wiring away from the wires running from the control panel to the burner controller. After wiring, check that the equipment is operating properly.
-  Be sure to connect non-voltage contacts to the inputs of this device (terminals 16 to 29).
-  After the power has been turned ON, leave sufficient time before checking the output. This device does not operate for about 8 seconds after the power has been turned ON.
-  The reset input (terminal 24) must be used by this device only. It cannot be shared with any other BC-R unit.

⚠ CAUTION

- ⚠ Output common terminals 4 and 5, and input common terminals 16 and 17 cannot be shared with any other BC-R unit.
- ⚠ Do not design instrumentation that shuts off the power to this device as soon as alarm output is generated. Doing so can corrupt this device's operation history records.
- ⚠ To prevent malfunction due to external electrical noise, do not operate the device with the loader cable except for trial runs, maintenance, and troubleshooting.
- ⚠ If there is an inverter or the like that generates strong electrical noise near this device, take noise-suppression measures, referring to the user's manual for the noise-generating equipment.

■ Installation method**⚠ WARNING**

- ⚠ Ensure you turn off the power of this device and all auxiliary devices when mounting, removing or connecting the wires of this device. There is a risk of electrical shock.

⚠ CAUTION

- ⚠ Mounting, wiring, maintenance, inspection, calibration, etc. should be carried out by a professional with technical training in combustion systems and combustion safety devices.
- ⚠ Never install in a place characterized by any of the following.
 - Certain chemicals or corrosive gases (ammonia, sulfur, chlorine, ethylene compounds, acids, etc.)
 - Dripping water or excessive humidity
 - High temperatures
 - Sustained long-term vibration
- ⚠ - For mounting and wiring, follow the instructions in this user's manual or in the combustion equipment manufacturer's manual.
- ⚠ Do not connect a load that exceeds the rating stated in the specifications to the control load terminals (terminals 2-1, 2-6, 2-7, or 2-8), and do not short-circuit the load. Doing so will burn out the internal fuse, making the device unusable. To comply with CE standards, it is necessary to take measures to prevent the use of a device whose relay contacts can be damaged by a connected load that exceeds the rating or by a load short-circuit. For this reason, this device uses an internal fuse that cannot be replaced.
- ⚠ When using the device as a burner control system, install it to a control panel that supports IP40 or more. If IP40 is required for this single device, also use a side board (sold separately). The protection structure of the device is equivalent to IP10.

■ Cautions regarding installation

- Take space 50 mm above and 0 below, 50 mm to the left and right, and 80 mm to the front, as **space for removal, wiring, and maintenance**. Also, do not install this device close to electric power devices or other sources of heat.

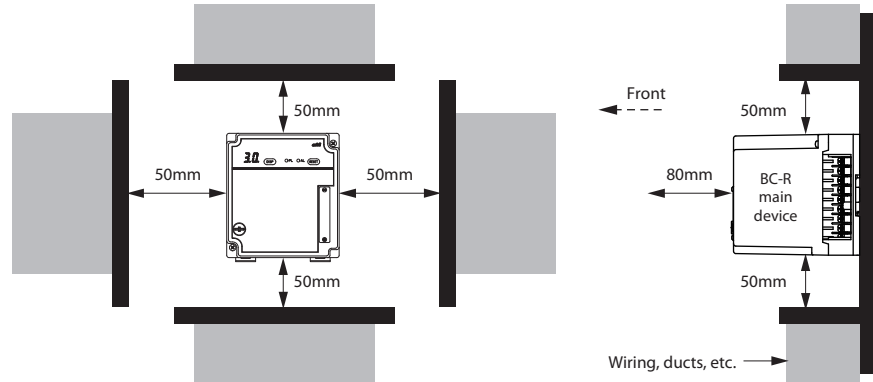

- This device must be grounded within a grounded and conductive control panel to ensure safety.
- Do not pull the wiring while it is attached to the device. Doing so can cause failures of the connectors or the device itself.

■ Installation orientation

Attach the device in the orientation shown below.

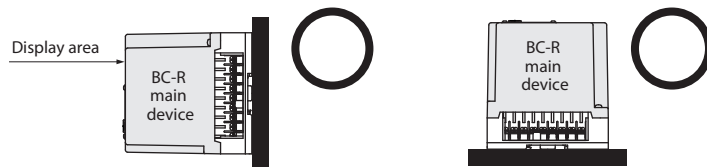

Do not install it in the orientations illustrated below.

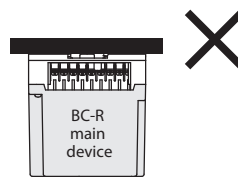

■ DIN rail mounting

- (1) Pull down the sub-base's DIN rail clamp.
- (2) Attach to the DIN rail while checking above and below the sub-base.
- (3) Push up the DIN rail clamp to attach the sub-base to the DIN rail.

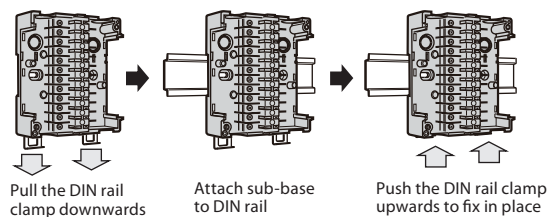

■ Mounting in a Panel

- (1) Drill two M4 screw holes into the panel.

(Unit: mm)

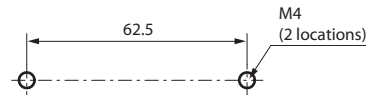

- (2) Use screws to mount the sub-base on the panel.
(Maximum tightening torque: 1.2 N·m)

⚠ CAUTION



Turn the power off before mounting the device on the sub-base.
Otherwise, device failure may occur.

■ Mounting / removing the device and sub-base (sold separately)

(Mounting)

- (1) Align the indentation in the center of the top of the device with the projection on the sub-base.

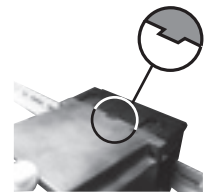

- (2) Once aligned as in (1), push straight downwards slowly.



- (3) Tighten the device's retaining screws to secure it in the sub-base. (Maximum tightening torque: 0.5 N·m)



(Removal)

- (1) Remove the retaining screws from the device.
(2) Pull it out horizontally while holding down the sub-base.



■ Terminal numbers, front panel item names

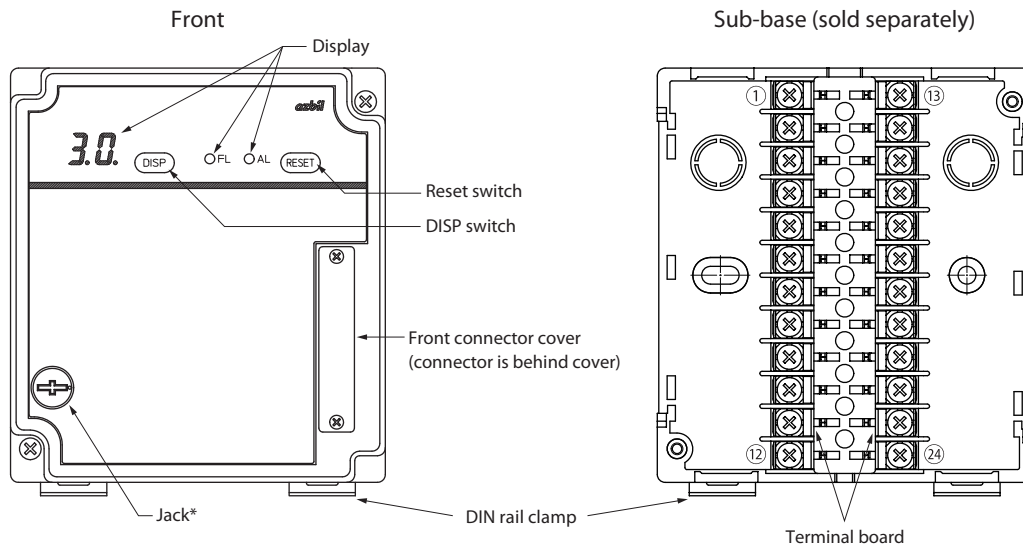

* Set the POC function as disabled
In BC-R35, also used as a smart loader package jack

● Terminal No.

Front terminals

No.	Function	No.	Function
25	Flame voltage output (+)	31	Power supply for monitor output
26	Flame voltage output (-)	32	Monitor output, combustion
27	Host communications (RS-485) DA	33	Monitor output, ignition failure
28	Host communications (RS-485) DB	34	Monitor output, flame failure
29	Host communications (RS-485) SG	35	Monitor output, lock-out interlock input
30	NC		

Sub-base terminals

No.	Function	No.	Function
1	Output for the blower motor (electromagnetic breaker)	13	Alarm output
2	AC power supply (L1)	14	Flame detector (F)
3	AC power supply (L2 (N))	15	Flame detector (G)
4	Output common 1	16	Input common 1
5	Output common 2	17	Input common 2
6	Ignition transformer output	18	Low fire interlock input
7	Pilot valve output	19	High fire interlock input
8	Main valve output	20	Startup input
9	Control motor output common	21	Air-flow switch input
10	Control motor proportional output	22	Lock-out interlock input
11	Control motor open output	23	POC (proof of closure) input
12	Control motor closed output	24	Contact reset input

● Connector for front wiring (81447514-001) terminal layout

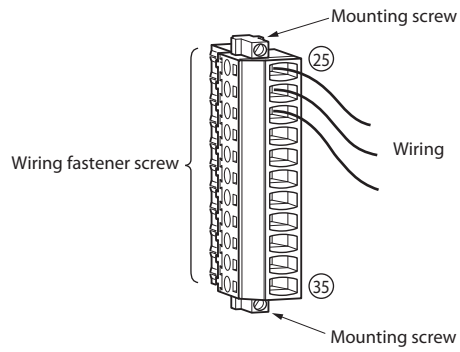

● Connector for front wiring (for right side wiring) (81447514-002) terminal layout

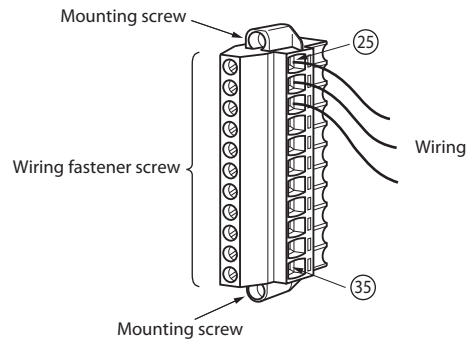

Example of wiring connection with external device

(Terminals 1 to 24: sub-base. Terminals 25 to 35: front connector.)

Interrupted pilot type (excluding the BC-R35F)

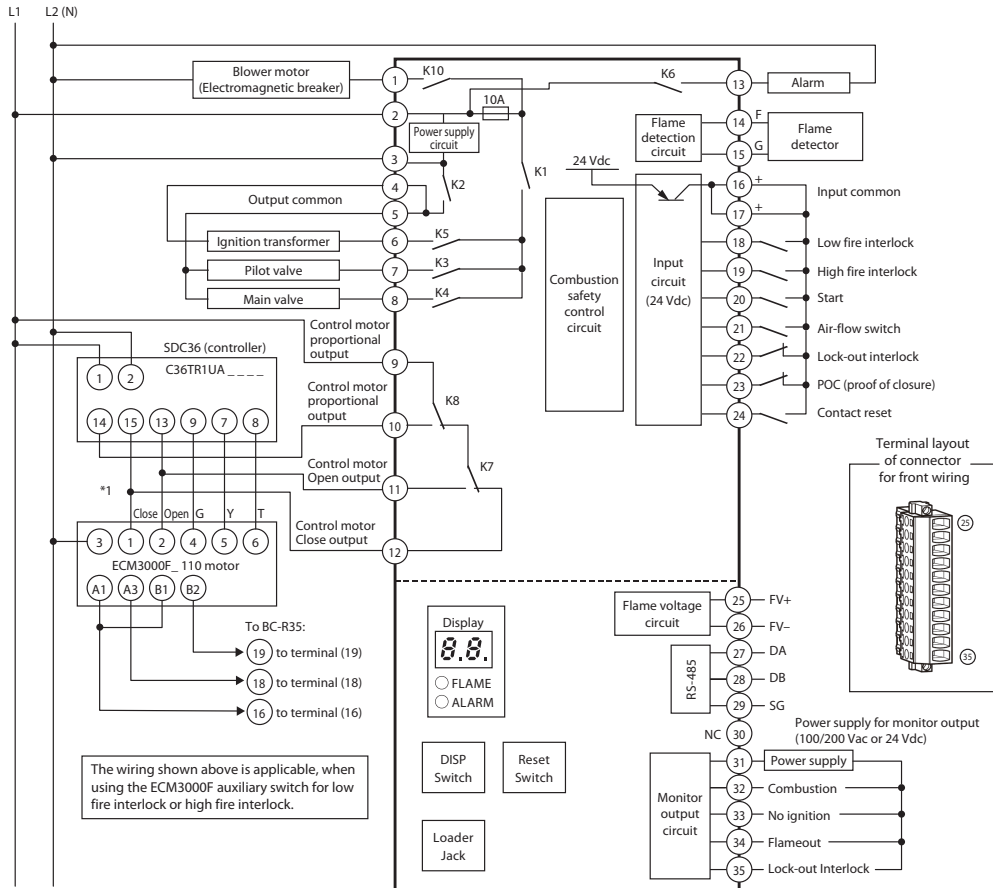

The wiring shown above is applicable, when using the ECM3000F auxiliary switch for low fire interlock or high fire interlock.

- Use contact reset (terminal 24) input in isolation. It cannot be used in conjunction with other BC-R contact reset inputs.
- Output common (terminals 4, 5) and input common (terminal 16, 17) cannot be used in conjunction with other BC-R.

*1 The following wiring is applicable, when using a proportional controller/ECM3000E, instead of the SDC36 controller/ECM3000F.

The wiring shown on the lower is applicable, when using the ECM3000E auxiliary switch for low fire interlock or high fire interlock.

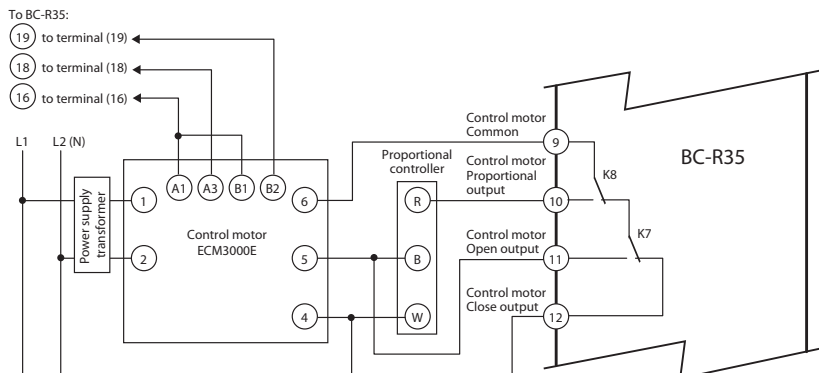

● Direct ignition type

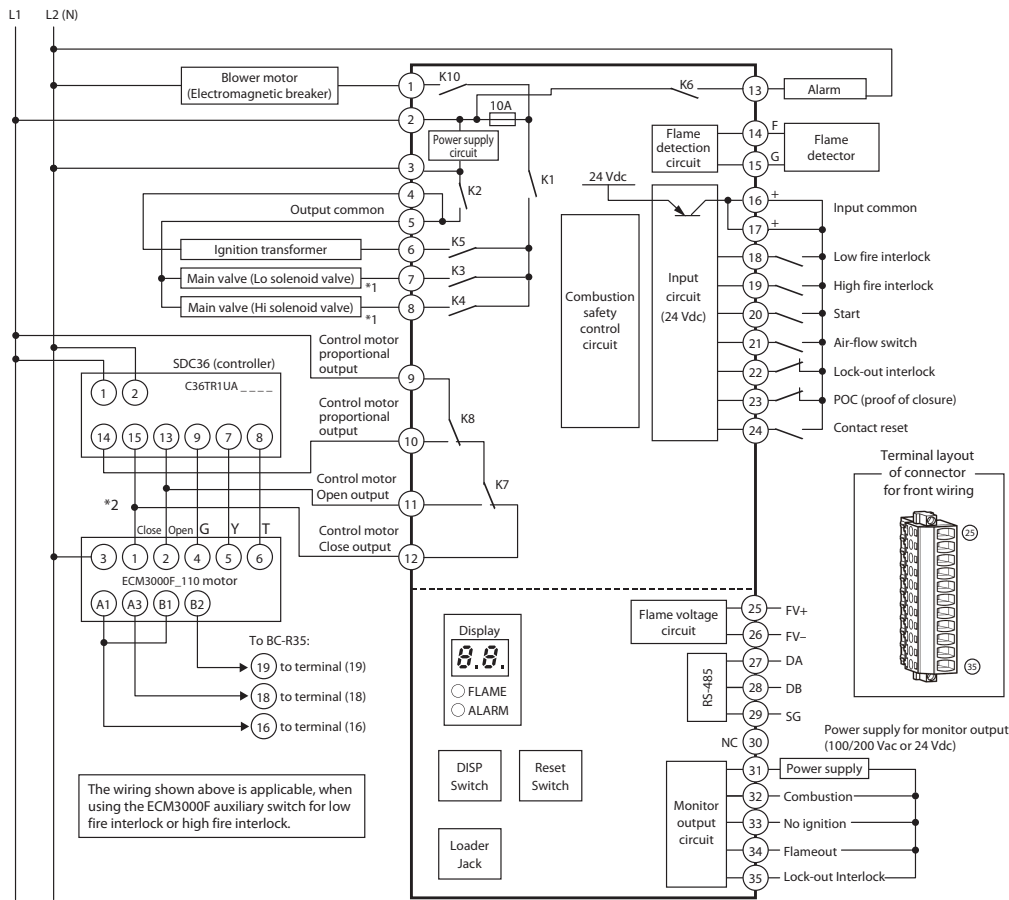

Notes

- Use contact reset (terminal 24) input in isolation. It cannot be used in conjunction with other BC-R contact reset inputs.
- Output common (terminals 4, 5) and input common (terminal 16, 17) cannot be used in conjunction with other BC-R.
- *1 Content in () describes the situation when three-position (Off-Lo-Hi) control is used. If other than three-position control is used, connect to main valve (terminal 7).
- *2 The following wiring is applicable, when using a proportional controller/ECM3000E, instead of the SDC36 controller/ECM3000F.

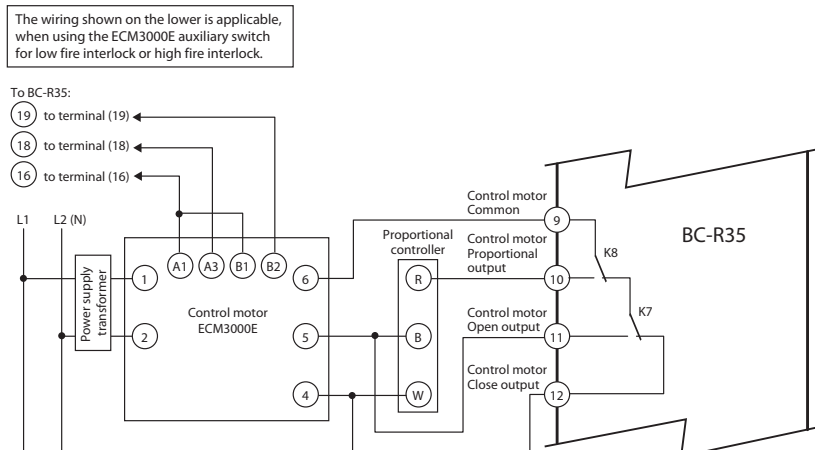

● For compliance with the standard on remote control of boilers (standards circular No. 0331001) when using the BC-R35F

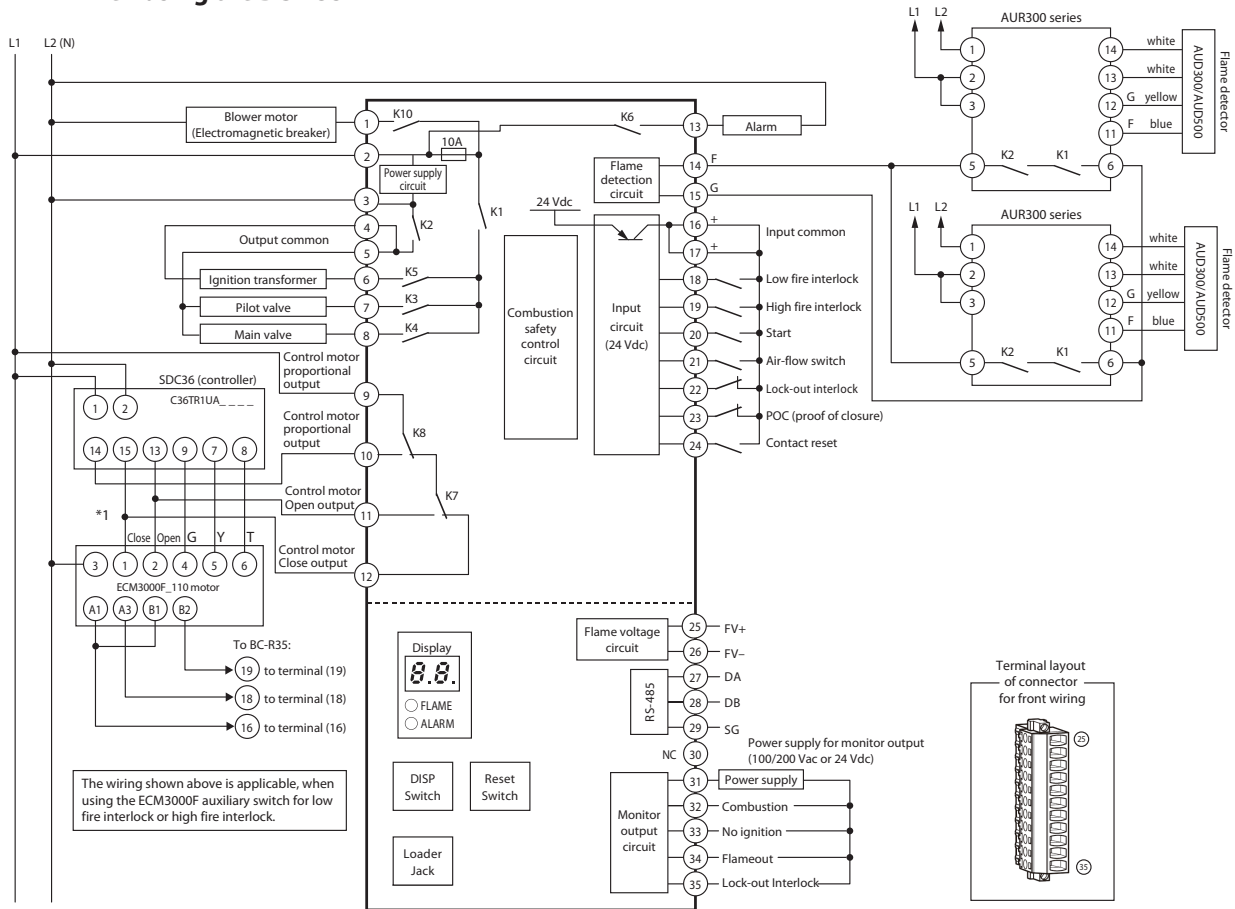

*1 See Page 11 and 12 for the following wiring is applicable, when using a proportional controller/ECM3000E, instead of the SDC36 controller/ECM3000F.

● Wiring with other control motors

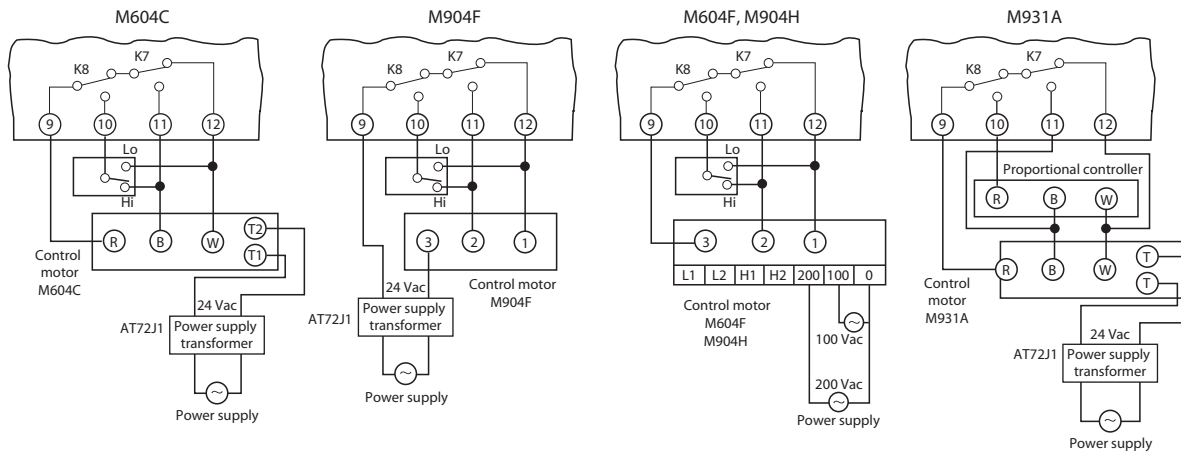

● **Wiring to a flame detector (UV sensor)**

• AUD100C+AUD15C

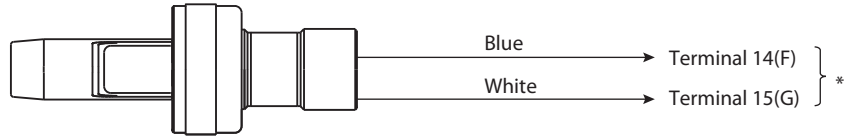

• AUD110C+AUD15C

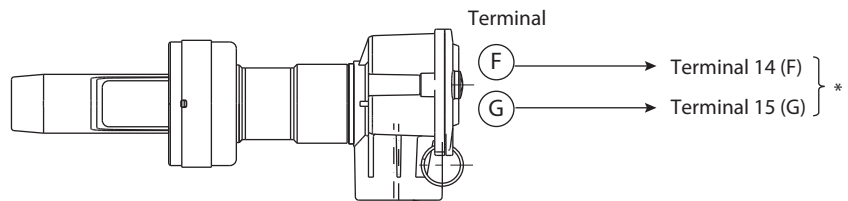

• AUD120C+AUD15C

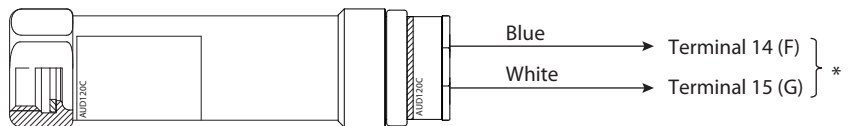

* If connection of the blue and white lead wires is reversed, or if the connections to terminals (F) and (G) are reversed, the AUD15C tube unit may be damaged.

● **Wiring to a rectification flame rod**

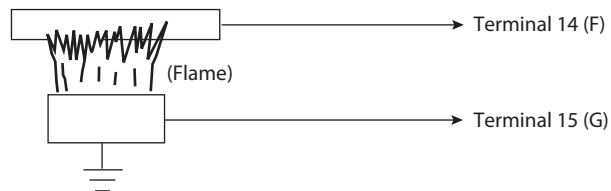

● **Wiring to an+ AFD100 visible light flame detector**

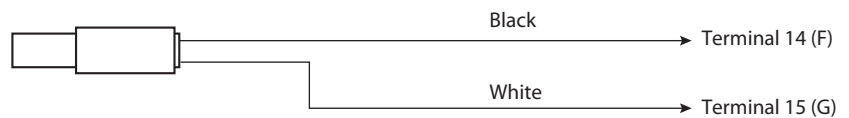

● Wiring to an AUR300C/350C contact input

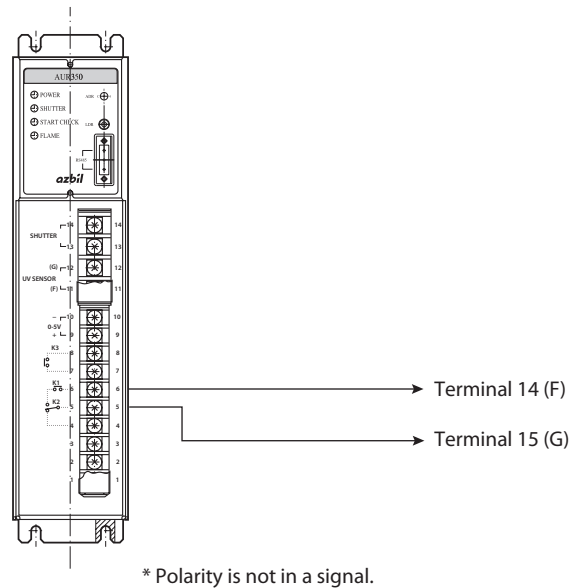

● Example countermeasures against power surges caused by lightning

When using a line surge suppressor as a countermeasure against power surges caused by lightning, connect it between Terminal 3 and the ground, as shown below.

The mounting brackets of the surge suppressor are crimp-on at the grounded side and inside and in conducting state.

Therefore, they can be grounded by simply attaching them to a grounded metal part such as the device cabinet.

When wiring to the power supply, use a lead wire of 0.75mm² (diameter: 0.18, strand count: 30) or more, which complies with JIS C 3306. Attach #187 Faston receptacle at one end and make the wire length as short as possible when connecting it.

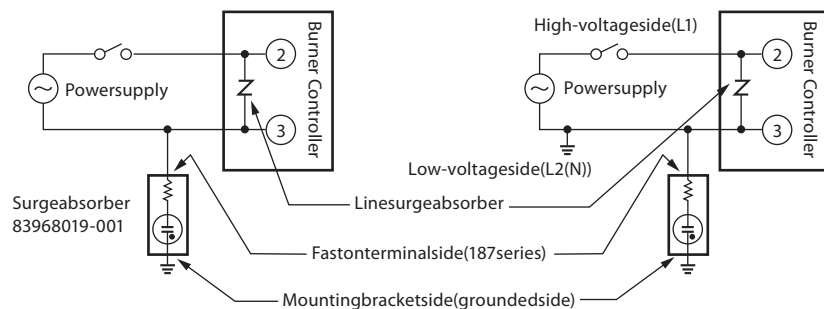

Chapter 3. Operation

Names of parts

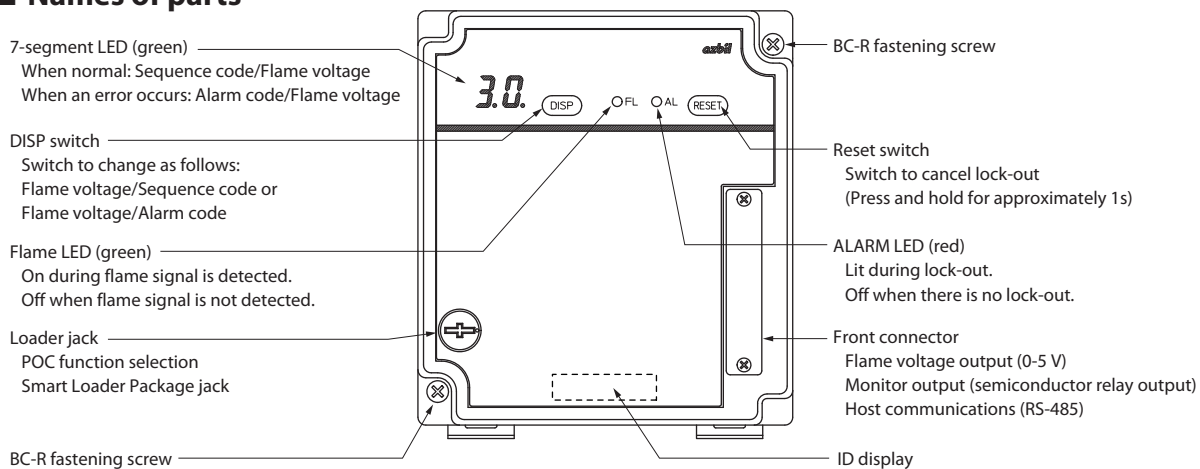

When a lock-out occurs, an alarm code is displayed automatically.
When an alarm occurs, the sequence code and alarm code issued when the lock-out occurred are displayed alternately.

ID display

Item	Notation
- Product number	BC-R35xxxxxxx
- Voltage	AC xxx V
- Flame detector (UV sensor)	UV
(Flame rod)	Ionization
(Visible light flame detector)	Visible
(Contact input)	Contact
- Timing display	
Pre-purge time	PPT xx s
Ignition trial	IGT xx s
Flame failure response time	FFRT xx s

Operation

● Operation switch

During normal operation

The 7-segment display shows a sequence code.
Every time the DISP switch is pressed, the display is changed between the sequence code and flame voltage alternately.

Sequence codes

• Interrupted pilot type

Display	Status content
P1	Start check
P2	Pre-purge
P3	Ignition standby
P4	Ignition trial
P5	Pilot stabilization
P6	Main trial
P7	Main stabilization
P8	RUN
P9	Post-purge
PL	Low fire stop
--	Controlled shutdown

• Direct ignition type

Display	Status content
P1	Start check
P2	Pre-purge
P3	Ignition standby
P4	Ignition trial
P5	Hi-valve ignition standby
P6	Hi-valve ignition
P7	Main stabilization
P8	RUN
P9	Post-purge
PL	Low fire stop
--	Controlled shutdown

When an error occurs

The 7-segment display shows an alarm code and the sequence code for which the alarm was issued alternately.

Every time the DISP switch is pressed, the display is changed between an alarm code and the sequence code for which the alarm was issued alternately as well as the flame voltage.

Alarm codes

Alarm codes	Sub-code	Description
E0	None	Interlock error
E1		False flame
E2		Air-flow switch error [1]
E3		Air-flow switch error [2]
E4		High fire interlock error
E5		Low fire interlock error [1][2]
E6		Ignition failure
E7		Flame failure
E8		POC (proof of closure) error*
E9		01
E9	02	Switch input
E9	03	Internal relay feedback (K1)
E9	04	Terminal 4 and 5 voltage discrepancy (K2)
E9	05	Terminal 7 voltage discrepancy (PV)
E9	06	Terminal 8 voltage discrepancy (MV)
E9	07	Terminal 6 voltage discrepancy (IG)
E9	08	Alarm activation at power ON
E9	50 or more	Device error

* Replace the burner controller, and if there is an alarm code E8, POC may have been set by the equipment manufacturer as disabled.
 In this case, check the equipment specification, and refer to “Function Setup Mode” on p. 20 if necessary.

Example display when an error occurs (Alarm code: Without a sub-code)

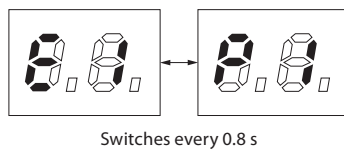

Example display when an error occurs (Alarm code: With a sub-code)

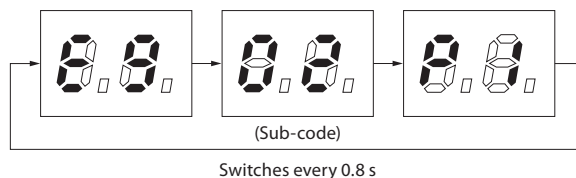

● Reset switch *

Lock-out is canceled when the reset switch is pressed and held for 1 s.

* After the lock-out is canceled, a stabilization time of approximately 5 seconds should be maintained.

During the stabilization time, no start input can be accepted.

- During postpurge, reset is not possible.

■ Trial operation mode

⚠ WARNING



Loads (the blower, ignition transformer, valves, etc.) operate in trial operation mode. They should be operated by a person with expert knowledge and an understanding of the functions. There is a risk of a major accident.

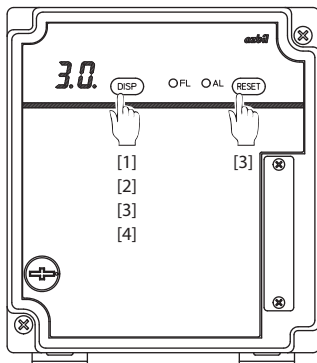

Transition to trial operation mode

- [1] Press and hold the DISP switch for approximately 5s or more during the stop sequence (when the start switch is Off). The 7-segment display changes to [$\mathcal{L}1$] and the system goes into trial operation mode. The central dot of the 7-segment display starts blinking. (on a 1 s cycle).

- [2] Each time the DISP switch is pressed, the display changes through the cycle [$\mathcal{L}1 \rightarrow \mathcal{L}2 \rightarrow \mathcal{L}3 \rightarrow \mathcal{L}4 \rightarrow \mathcal{L}5 \rightarrow \mathcal{L}6$].

Display	Description
$\mathcal{L}1$	Continuous pilot burn mode (only main valve 1 with direct ignition)
$\mathcal{L}2$	Monitor output, combustion
$\mathcal{L}3$	Monitor output, ignition failure
$\mathcal{L}4$	Monitor output, flame failure
$\mathcal{L}5$	Monitor output, lock-out interlock
$\mathcal{L}6$	Forced control motor open output, blower output On
$\mathcal{L}7$	Forced control motor close output, blower output On
$\mathcal{L}8$	Control motor proportional output, blower output On
$\mathcal{L}9$	Forced control motor open output, blower output Off
$\mathcal{L}A$	Forced control motor close output, blower output Off
$\mathcal{L}b$	Control motor proportional output, blower output Off

Trial operation setup

■ Trial-run operation mode selection

- [3] Select test operation type using the DISP switch.

When $\mathcal{L}1$ is selected

- 1 Press the Reset button when $\mathcal{L}1$ is displayed. The 7-segment display shows [- -] blinking.
- 2 The combustion sequence starts when start input is received. At that stage, the sequence code blinks. (It is steadily lit in normal mode.)

When $\mathcal{L}2$ - $\mathcal{L}b$ is selected

- 1 Press the Reset button to enter selection mode. The 7-segment display shows [$\mathcal{L} - / \mathcal{O} \mathcal{F}$].
- 2 When the DISP switch is pressed in this situation, the display toggles between [$\mathcal{L} - / \mathcal{O} \mathcal{F}$] and [$\mathcal{L} - \mathcal{O} \mathcal{N}$], and trial operation runs according to the On/Off selection.
- 3 When the Reset switch is pressed to stop trial operation, the display for selecting types of trial operation ([2] above) is displayed.

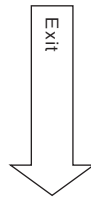

- [4] Press and hold the DISP switch for 5 s or more to end trial operation mode.
Trial operation mode also ends in the following situations.
- Power Off.
 - Alarm is issued during trial operation mode (in continuous pilot burn mode).

1.1 Continuous pilot burn mode (㉟)

In the combustion sequence, only the pilot burns and main ignition is not performed.

A lock-out occurs if there is an error.

1.2 Forced flame monitor output (㉠)

This function forces the monitor output to perform output to check the operations of indicators and other components that are connected to the monitor output terminal.

1.3 Forced ignition failure monitor output (㉡)

This function forces the monitor output to perform output to check the operations of indicators and other components that are connected to the monitor output terminal.

Forces the monitor output (ignition failure) ON or OFF.

1.4 Forced flame failure monitor output (㉢)

This function forces the monitor output to perform output to check the operations of indicators and other components that are connected to the monitor output terminal.

Forces the monitor output (flame failure) ON or OFF.

1.5 Forced lock-out interlock monitor output (㉣)

This function forces the monitor output to perform output to check the operations of indicators and other components that are connected to the monitor output terminal.

Forces the monitor output (lock-out interlock) ON or OFF.

1.6 Forced control motor Hi output, blower output On (㉤)

Allows checking of air-flow when the control motor is open and blower motor (electromagnetic breaker) output is performed.

1.7 Forced control motor Lo output, blower output On (㉥)

Allows checking of air-flow when the control motor is closed and blower motor (electromagnetic breaker) output is performed.

1.8 Control motor proportional output, blower output On (㉦)

Allows checking of air-flow when the control motor is proportional and blower motor (electromagnetic breaker) output is performed.

1.9 Forced control motor Hi output, blower output Off (㉧)

Allows the control motor to be set for opening output for checking the limit switch position.

1.10 Forced control motor Lo output, blower output Off (㉨)

Allows the control motor to be set for closing output for checking the limit switch position.

1.11 Control motor proportional output, blower output Off (㉩)

Allows the control motor to be set for proportional output for checking the limit switch position.

■ Function setting mode (for POC and host communications (RS-485) address)

⚠ CAUTION

- ❗ If POC is selected, the lower right dot of the 7-segment display is lit, regardless of the operation mode. If devices installed in the system are set without selecting POC (proof of closure), an E8 error is issued when this device is replaced, unless the new device is set without POC (proof of closure) selection.
- ❗ In regular modes other than equipment setting mode, remove the dedicated pin plug.

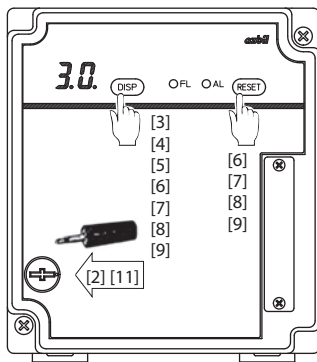

Transition to function setting mode

- [1] Turn the power Off.
- [2] Insert the dedicated pin plug into the loader jack connector. (MP-101MLA made by Marushin Musen)
- [3] Turn on the power while holding the DISP switch down. (approx. 10 seconds).
The 7-segment display shows a blinking [H-], (with a blink cycle of 0.4 seconds) and ALARM LED blinks. (on a 1 s blink cycle).
- [4] Release the DISP switch, then press and hold it again for at least 5 s. The 7-segment display shows [H !], and the mode switches to function selection mode. (The ALARM LED continues to blink)
☞ If the 7-segment display flashes [σ-/-σ] for 2.4 s, the transition to function selection mode has not succeeded. The pin plug may not be inserted correctly.
- [5] Each time the DISP switch is pressed, the display changes through the cycle [→H1→H2→H3→H4 →].

Various settings

Display	Description
H1	POC (proof of closure) selection settings
H2	Communications address setting
H3	Baud rate setting
H4	Communications format setting

• Factory settings

Model number	Settings
BC-R35A	OFF: POC function disabled
BC-R35B/C/F	ON: POC function enabled

■ POC (proof of closure) action selection setting

- [6] Use the DISP switch to select 7-segment display [H !].
 - 1 Press the Reset button.
The 7-segment display shows [H !oF] or [H !oN].
 - 2 When the DISP switch is pressed in this situation, the display toggles between [H !oF] and [H !oN], and the POC action selection is changed between On and Off.

ON	POC function enabled
OFF	POC function disabled
 - 3 After making the selection, press the Reset switch to confirm the setting.
If On (with POC function enabled) is selected at this stage, the display is [H !].
While the POC function is active, a dot appears in the lower right area of the 7 segment display.
While the POC function is inactive, [H !] is active, and no dot appears in the lower right area of the 7 segment display.

• Factory settings

Model number	Settings
BC-R35A/B/C/F	1

• Factory settings

Model number	Settings
BC-R35A/B/C/F	3: 19200 bps

• Factory settings

Model number	Settings
BC-R35A/B/C/F	1: Even parity 1 Stop bit

Various settings

■ **Communications address setting**

[7] Use the DISP switch to select 7 segment display [H2].

- 1 Press the Reset button.
The 7-segment display shows [H2/xx], where xx is the address value.
- 2 When the DISP switch is pressed in this situation, the display toggles between [\rightarrow H2/1 \rightarrow H2/2 \rightarrow H2/3 \dots H2/32 \leftarrow].
Make the address selection.
- 3 After making the selection, press the Reset switch to confirm.
At this stage, the display is [H2].

■ **Baud rate setting**

[8] Use the DISP switch to select 7-segment display [H3].

- 1 Press the Reset button.
The 7-segment display shows [H3/xx], where XX is 1-3
1: 4800 bps
2: 9600 bps
3: 19200 bps
- 2 When the DISP switch is pressed in this situation, the display cycles through [\rightarrow H3/1 \rightarrow H3/2 \rightarrow H3/3 \leftarrow].
Make the baud rate selection.
- 3 After making the selection, press the Reset switch to confirm.
At this stage, the display is [H4].

■ **Communications format setting**

[9] Use the DISP switch to select 7 segment display [H4].

- 1 Press the Reset button.
The 7-segment display shows [H4/xx], where xx is 1-4
1: Even parity, 1 Stop bit
2: Even parity, 2 Stop bits
3: Odd parity, 1 Stop bit
4: Odd parity, 2 Stop bits
- 2 When the DISP switch is pressed in this situation, the display cycles through [\rightarrow H4/1 \rightarrow H4/2 \rightarrow H4/3 \leftarrow].
Select the communications format.
- 3 After making the selection, press the Reset switch to confirm.
At this stage, the display is [H4].

[10] Turn the power Off.

[11] Remove the pin plug.



■ Host communication settings using the Smart Loader Package (SLP-BCR)

Function setting mode [M2], [M3] and [M4] (host communication (RS-485) setting) can also be set using the Smart Loader Package.

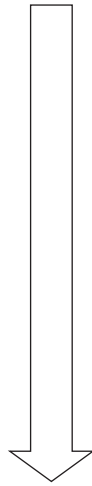

- [1] Turn off the power of the product.
- [2] Remove the wiring of RS-485.
Insert one end of the USB loader cable into the loader jack of the product, and then insert the other end into a USB port of the PC.
- [3] Turn on the power of the product.
- [4] Start SLP-BCR and set host communication.
(Do not turn off the power for 5 seconds after pressing the [Set] button, as data is being written.)
- [5] Turn off the power of the product.
Remove the USB loader cable.
Connect RS-485.
- [6] Turn on the power of the product.
- [7] Start communications with the host device.

Chapter 4. Explanation of Operation

CAUTION



Even if the start input is turned on, this device does not begin operation until approximately 8 seconds after power supply being turned on.

Therefore, give sufficient time after turning on the power, then check the output of the device.



As the start input uses a 24 Vdc input circuit, it takes approximately 1 second to confirm it.

Example of wiring connection with external device

(Terminals 1 to 24: sub-base. Terminals 25 to 35: front connector.)

Interrupted pilot type (excluding the BC-R35F)

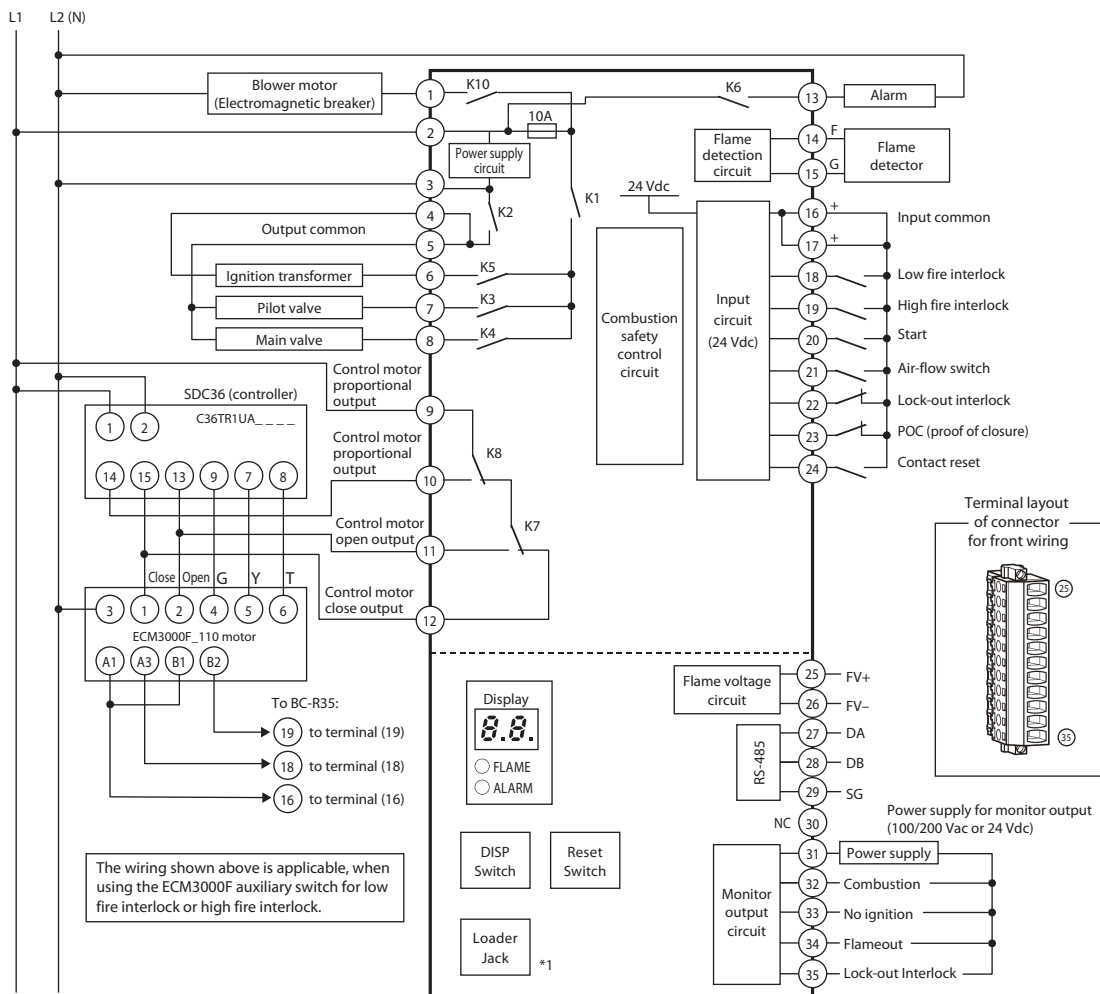

● Direct ignition type

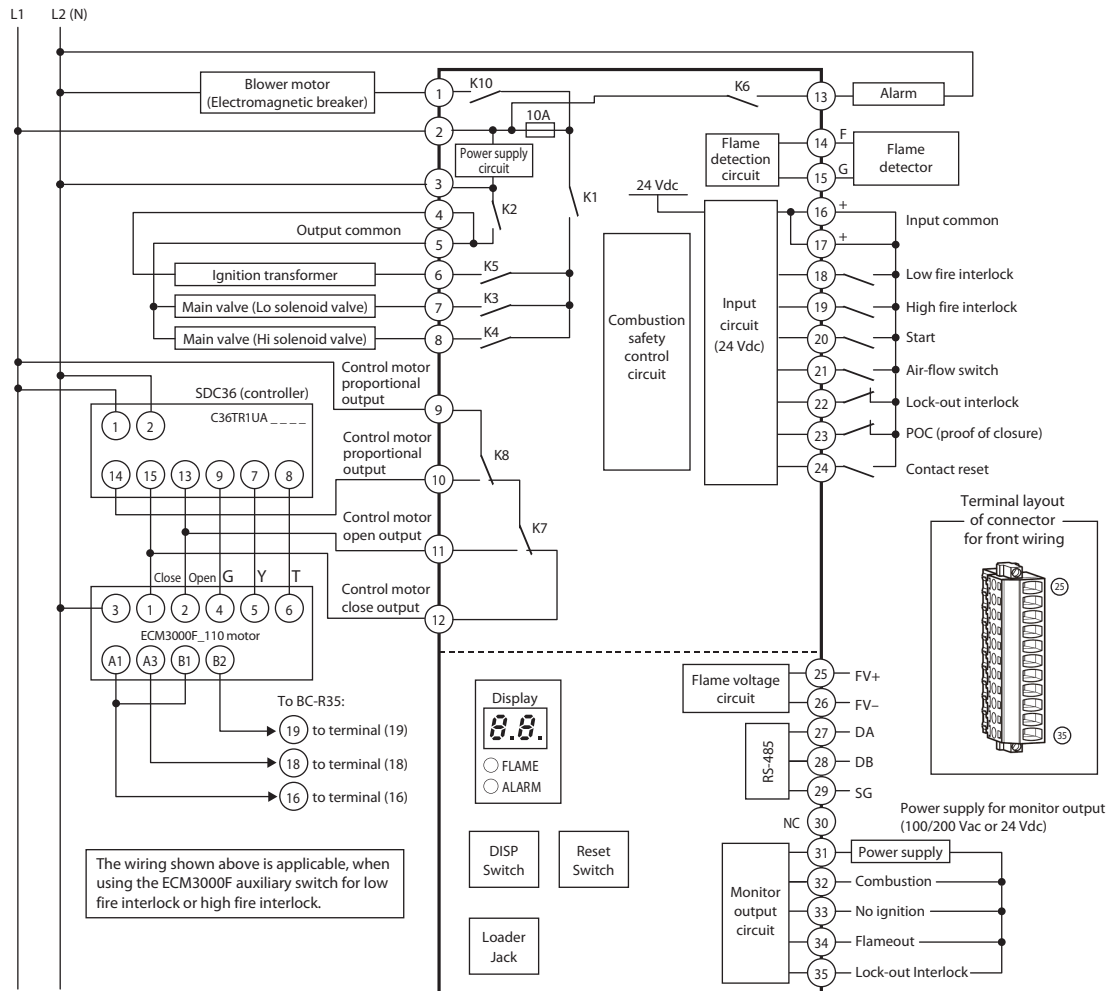

! Handling Precautions

- POC (proof of closure) is checked in synchronization with the operation of the main valve for the interrupted pilot type, or the operation of the Lo solenoid valve (main valve) for the direct ignition type.

● For compliance with the standard on remote control of boilers (Standards circular No. 0331001) when using the BC-R35F

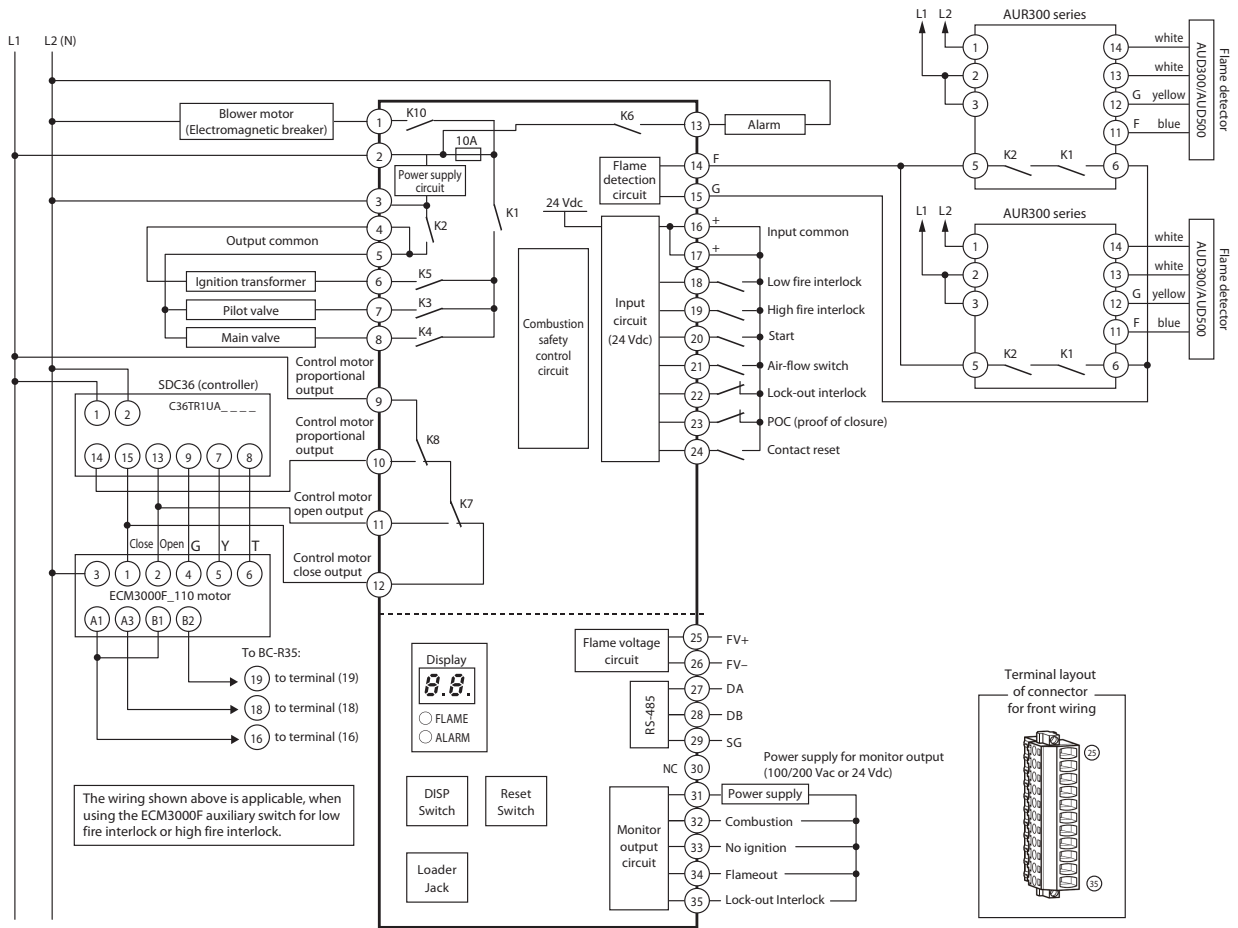

■ Operation Sequence

● Normal operation

- Interrupted pilot type (without low fire shutdown)

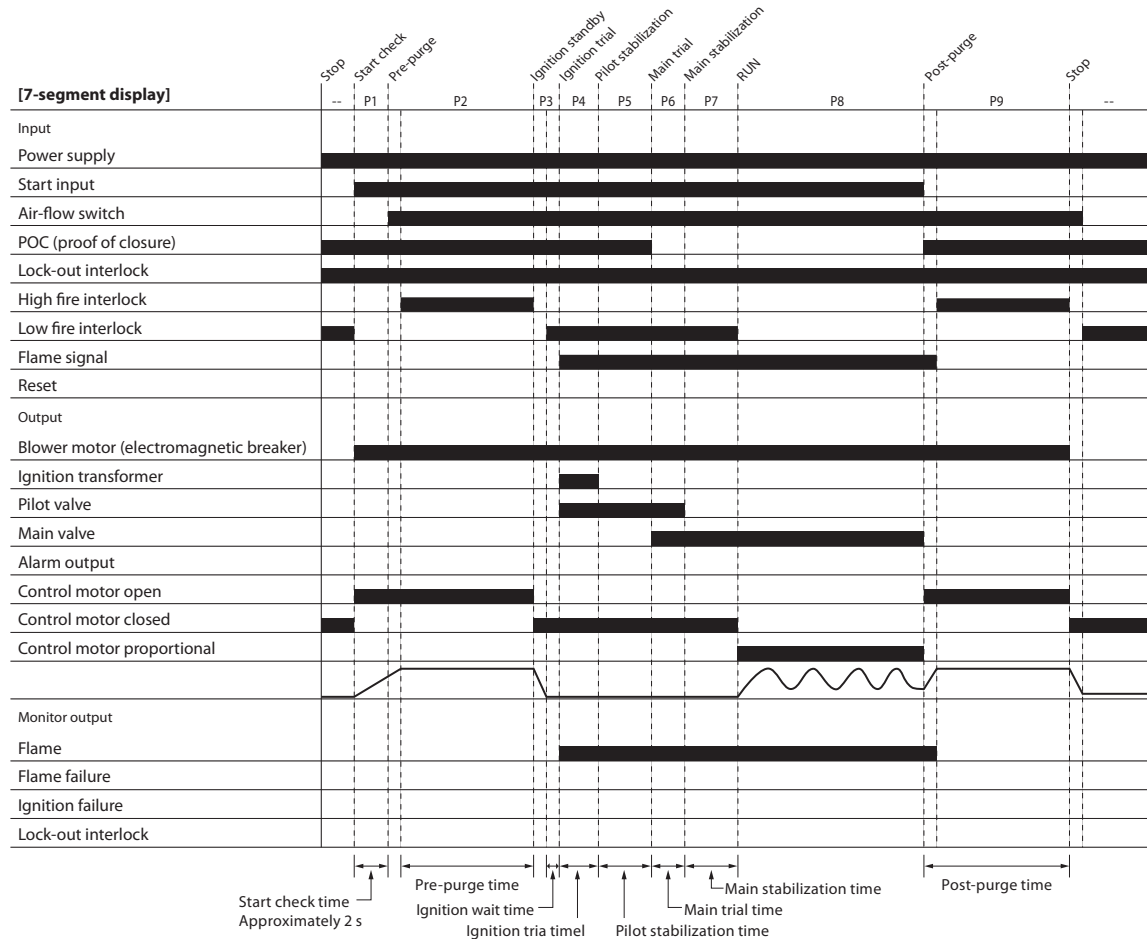

Input	Action	Sequence codes
Startup input ON	When the start input is turned ON, K7 is turned ON and the control motor opening signal is output. When the air-flow switch is confirmed to be OFF, K10 is turned ON and output for the blower motor is turned ON. An internal circuit check is done to make sure that lock-out interlock is ON (normal), and that the shutoff valve proof of closure switch is ON (if the POC function is enabled).	P1
	When the air-flow switch and high fire interlock are turned ON, timing of the pre-purge begins.	P2
	When the pre-purge time has elapsed, K7 is turned OFF, the control motor closure signal is output, and low fire interlock is confirmed to be ON.	P3
	After low fire interlock ON is confirmed, K3 and K5 are turned ON, and output is sent to the ignition transformer and pilot valve.	P4
	If a flame signal can be detected, K5 is turned OFF when the pilot ignition time has elapsed, and the ignition transformer is turned OFF.	P5
	K4 is turned ON and the main valve is turned ON. Within 3 seconds after the main valve is turned ON a check is done to make sure that the shutoff valve proof of closure switch is OFF (if the POC function is enabled).	P6
	When main burner ignition is completed, K3 is turned OFF, the pilot valve is turned OFF, and main burner ignition status is maintained until the main flame stabilization time has elapsed.	P7
	K8 is turned ON and control motor proportioning is output. Normal combustion continues in this state until the start input is turned OFF.	P8
Startup input OFF	When the start input is turned OFF, K8 is turned OFF, K7 is turned ON, and the control motor opening signal is output. At the same time, K1, K2, and K4 are turned OFF and the main valve is turned OFF. K10 remains ON to keep the blower output ON, and timing of the post-purge begins.	P9
	After the post-purge time has elapsed, K10 is turned OFF, output for the blower motor is turned OFF, K7 is turned OFF, and the control motor closure signal is output. The system stands by until the start input is again turned ON.	-

● Normal operation

- Interrupted pilot type (with low fire shutdown)

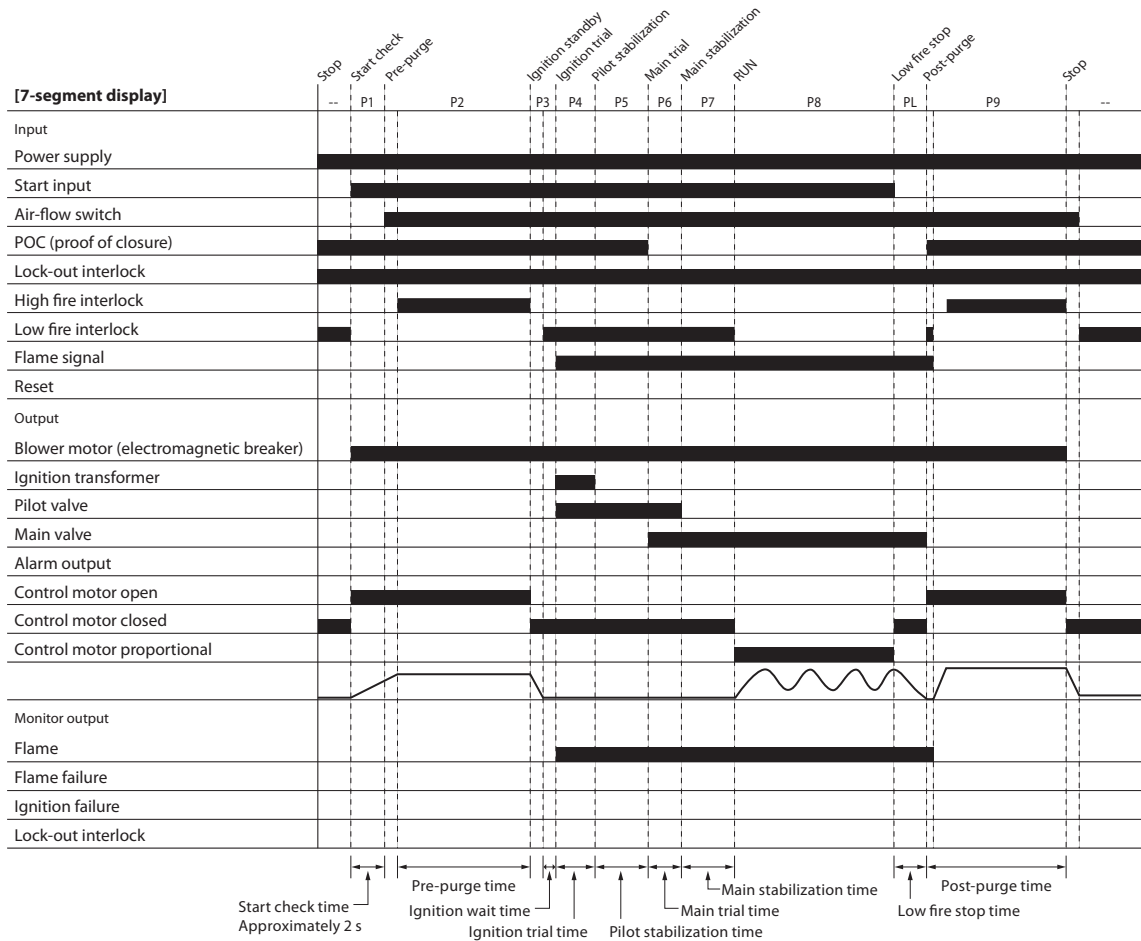

Input	Action	Sequence codes
Startup input ON	When the start input is turned ON, K7 is turned ON and the control motor opening signal is output. When the air-flow switch is confirmed to be OFF, K10 is turned ON and output for the blower motor is turned ON. An internal circuit check is done to make sure that lock-out interlock is ON (normal), and that the shutoff valve proof of closure switch is ON (if the POC function is enabled).	P1
	When the air-flow switch and high fire interlock are turned ON, timing of the pre-purge begins.	P2
	When the pre-purge time has elapsed, K7 is turned OFF, the control motor closure signal is output, and low fire interlock is confirmed to be ON.	P3
	After low fire interlock ON is confirmed, K3 and K5 are turned ON, and output is sent to the ignition transformer and pilot valve.	P4
	If a flame signal can be detected, K5 is turned OFF when the pilot ignition time has elapsed, and the ignition transformer is turned OFF.	P5
	K4 is turned ON and the main valve is turned ON. Within 3 seconds after the main valve is turned ON a check is done to make sure that the shutoff valve proof of closure switch is OFF (if the POC function is enabled).	P6
	When main burner ignition is completed, K3 is turned OFF, the pilot valve is turned OFF, and main burner ignition status is maintained until the main flame stabilization time has elapsed.	P7
K8 is turned ON and control motor proportioning is output. Normal combustion continues in this state until the start input is turned OFF.	P8	
Startup input OFF	When the start input is turned OFF, K8 is turned OFF and the control motor closure signal is output. Under those conditions the low fire shutdown time is then counted down.	PL
	When the low fire shutdown time has elapsed, or when the low fire interlock is turned ON, K7 is turned ON and the control motor opening signal is output. At the same time, K1, K2, and K4 are turned OFF and the main valve is turned OFF. K10 remains ON to keep the blower output ON, and timing of the post-purge begins.	P9
	After the post-purge time has elapsed, K10 is turned OFF, output for the blower motor is turned OFF, K7 is turned OFF, and the control motor closure signal is output. The system stands by until the start input is again turned ON.	-

● Normal operation

- Direct ignition type (without low fire shutdown)

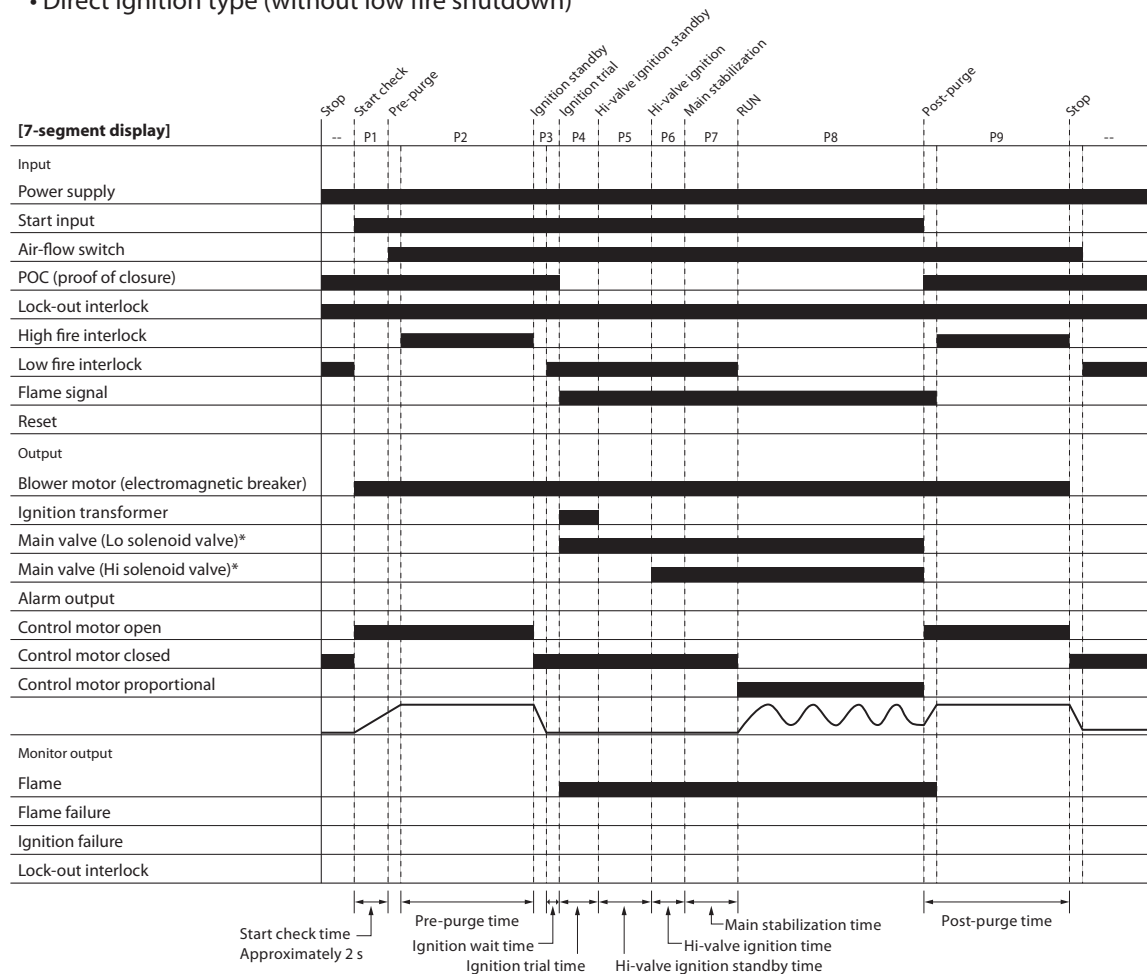

* Content in () describes the situation when three-position (Off-Lo-Hi) control is used.
If other than three-position control is used, only look at the main valve (Lo-valve)

Input	Action	Sequence codes
Startup input ON	When the start input is turned ON, K7 is turned ON and the control motor opening signal is output. When the air-flow switch is confirmed to be OFF, K10 is turned ON and output for the blower motor is turned ON. An internal circuit check is done to make sure that lock-out interlock is ON (normal), and that the shutoff valve proof of closure switch is ON (if the POC function is enabled).	P1
	When the air-flow switch and high fire interlock are turned ON, timing of the pre-purge begins.	P2
	When the pre-purge time has elapsed, K7 is turned OFF, the control motor closure signal is output, and low fire interlock is confirmed to be ON.	P3
	After low fire interlock is confirmed to be ON, K3 and K5 are turned ON, and output to the ignition transformer and Lo solenoid valve is turned ON. Within 3 seconds after the Lo solenoid valve is turned ON, a check is done to make sure that the shutoff valve proof of closure switch is OFF (if the POC function is enabled).	P4
	If a flame signal can be detected, K5 is turned OFF when the ignition time elapses, and the ignition transformer is turned OFF.	P5
	K4 is turned ON and Hi solenoid valve is turned ON.	P6
	The Hi solenoid valve ignition status is maintained until the main flame stabilization time has elapsed.	P7
Startup input OFF	When the main flame stabilization time has elapsed, K8 is turned ON and control motor proportioning is output. Normal combustion continues in this state until the start input is turned OFF.	P8
	When the start input is turned OFF, K8 is turned OFF, K7 is turned ON, and the control motor opening signal is output. At the same time, K1, K2, K3, and K4 are turned OFF, and Hi/Lo solenoid valves are turned OFF. K10 remains ON to keep the blower output ON, and timing of the post-purge begins.	P9
	After the post-purge time has elapsed, K10 is turned OFF, output for the blower motor is turned OFF, K7 is turned OFF, and the control motor closure signal is output. The system stands by until the start input is again turned ON.	-

● Normal operation

- Direct ignition type (with low fire shutdown)

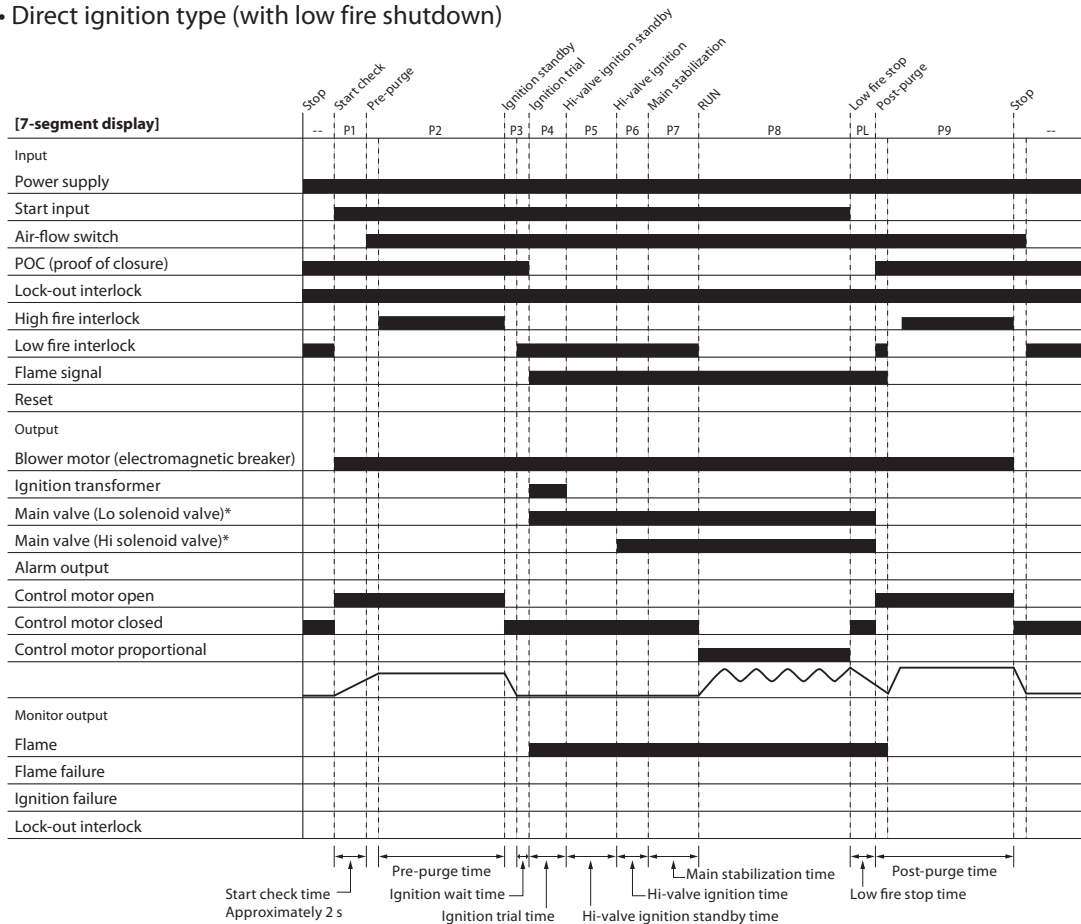

* Content in () describes the situation when three-position (Off-Lo-Hi) control is used. If other than three-position control is used, only look at the main valve (Lo-valve)

Input	Action	Sequence codes
Startup input ON	When the start input is turned ON, K7 is turned ON and the control motor opening signal is output. When the air-flow switch is confirmed to be OFF, K10 is turned ON and output for the blower motor is turned ON. An internal circuit check is done to make sure that lock-out interlock is ON (normal), and that the shutoff valve proof of closure switch is ON (if the POC function is enabled).	P1
	When the air-flow switch and high fire interlock are turned ON, timing of the pre-purge begins.	P2
	When the pre-purge time has elapsed, K7 is turned OFF, the control motor closure signal is output, and low fire interlock is confirmed to be ON.	P3
	After low fire interlock is confirmed to be ON, K3 and K5 are turned ON, and output to the ignition transformer and Lo solenoid valve is turned ON. Within 3 seconds after the Lo solenoid valve is turned ON, a check is done to make sure that the shutoff valve proof of closure switch is OFF (if the POC function is enabled).	P4
	If a flame signal can be detected, K5 is turned OFF when the ignition time elapses, and the ignition transformer is turned OFF.	P5
	K4 is turned ON and Hi solenoid valve is turned ON.	P6
	The Hi solenoid valve ignition status is maintained until the main flame stabilization time has elapsed.	P7
	When the main flame stabilization time has elapsed, K8 is turned ON and control motor proportioning is output. Normal combustion continues in this state until the start input is turned OFF.	P8
Startup input OFF	When the start input is turned OFF, K8 is turned OFF and the control motor closure signal is output. Under those conditions the low fire shutdown time is then counted down.	PL
	When the low fire shutdown time has elapsed, or when the low fire interlock is turned ON, K7 is turned ON and the control motor opening signal is output. At the same time, K1, K2, K3, and K4 are turned OFF, and Hi/Lo solenoid valves are turned OFF. K10 remains ON to keep the blower output ON, and timing of the post-purge begins.	P9
	After the post-purge time has elapsed, K10 is turned OFF, output for the blower motor is turned OFF, K7 is turned OFF, and the control motor closure signal is output. The system stands by until the start input is again turned ON.	-

● Ignition failure

- Interrupted pilot type (with or without low fire shutdown)

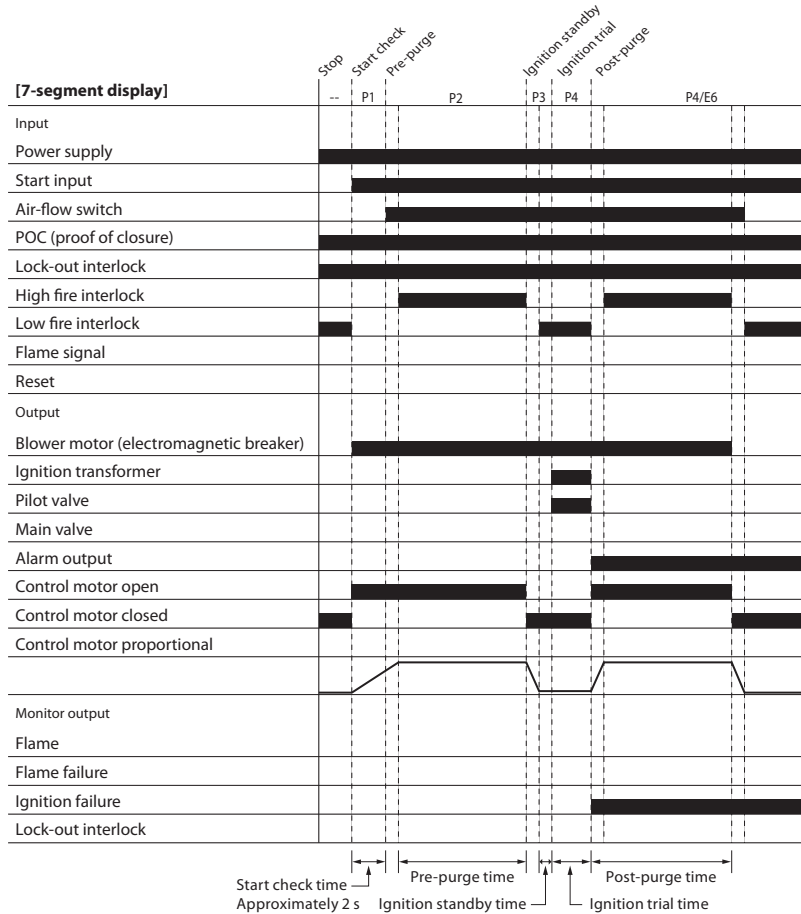

Input	Action	Sequence codes
Startup input ON	When the start input is turned ON, K7 is turned ON and the control motor opening signal is output. When the air-flow switch is confirmed to be OFF, K10 is turned ON and output for the blower motor is turned ON. An internal circuit check is done to make sure that lock-out interlock is ON (normal), and that the shutoff valve proof of closure switch is ON (if the POC function is enabled).	P1
	When the air-flow switch and high fire interlock are turned ON, timing of the pre-purge begins.	P2
	When the pre-purge time has elapsed, K7 is turned OFF, the control motor closure signal is output, and low fire interlock is confirmed to be ON.	P3
	After low fire interlock ON is confirmed, K3 and K5 are turned ON, and output is sent to the ignition transformer and pilot valve.	P4
	If a flame cannot be detected before the pilot ignition time elapses, K3 and K5 are turned OFF, K6 is turned ON, and lock-out occurs. With regards to monitor output, ignition failure output is generated. In that case, K10 remains ON, output for the blower motor continues until post-purge is complete, K8 is turned OFF, K7 is turned ON, and the control motor opening signal is output. After the post-purge time has elapsed, K7 is turned OFF, the control motor closure signal is output, K10 is turned OFF, and output for the blower motor is turned OFF. During post-purge, reset operation is not accepted.	P4/E6

● Ignition failure

- Direct ignition type (with or without low fire shutdown)

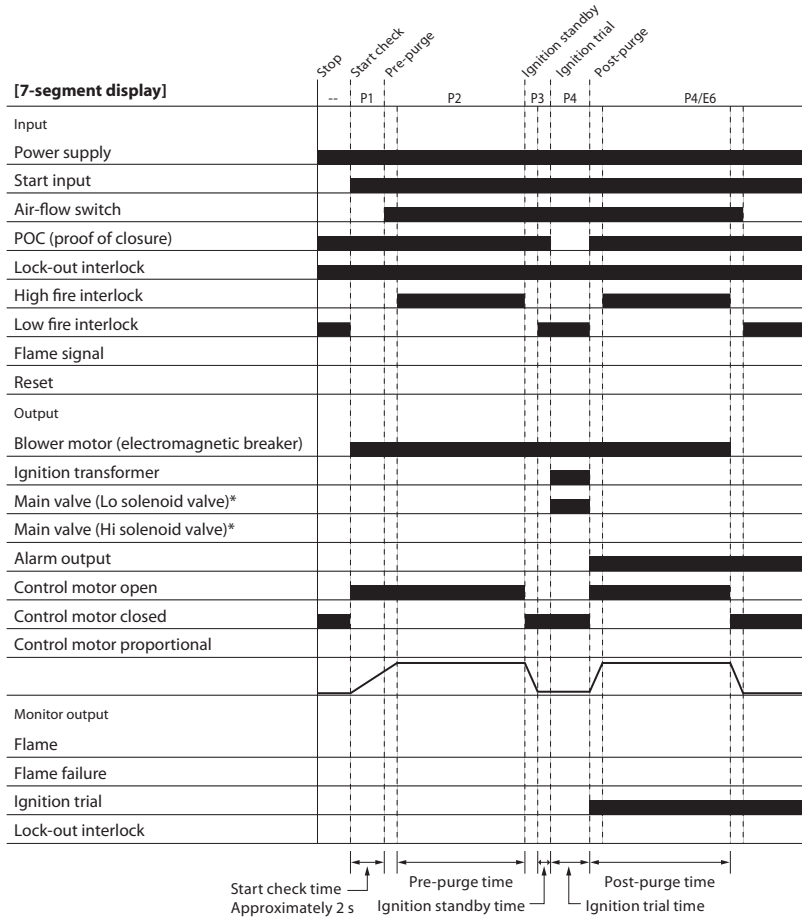

* Content in () describes the situation when three-position (Off-Lo-Hi) control is used. If other than three-position control is used, only look at the main valve (Lo-valve)

Input	Action	Sequence codes
Startup input ON	When the start input is turned ON, K7 is turned ON and the control motor opening signal is output. When the air-flow switch is confirmed to be OFF, K10 is turned ON and output for the blower motor is turned ON. An internal circuit check is done to make sure that lock-out interlock is ON (normal), and that the shutoff valve proof of closure switch is ON (if the POC function is enabled).	P1
	When the air-flow switch and high fire interlock are turned ON, timing of the pre-purge begins.	P2
	When the pre-purge time has elapsed, K7 is turned OFF, the control motor closure signal is output, and low fire interlock is confirmed to be ON.	P3
	After low fire interlock is confirmed ON, K3 and K5 are turned ON and output is sent to the ignition transformer and Lo solenoid valve. Within 3 seconds after the Lo solenoid valve is turned ON, a check is done to make sure that the shutoff valve proof of closure switch is OFF (if the POC function is enabled).	P4
	If a flame cannot be detected before the ignition time elapses, K3 and K5 are turned OFF, K6 is turned ON, and lock-out occurs. With regards to monitor output, ignition failure output is generated. In that case, K10 remains ON, output for the blower motor continues until post-purge is complete, K8 is turned OFF, K7 is turned ON, and the control motor opening signal is output. After the post-purge time has elapsed, K7 is turned OFF, the control motor closure signal is output, K10 is turned OFF, and output for the blower motor is turned OFF. During post-purge, reset operation is not accepted.	P4/E6

● **Flame failure**

- Interrupted pilot type (with or without low fire shutdown)

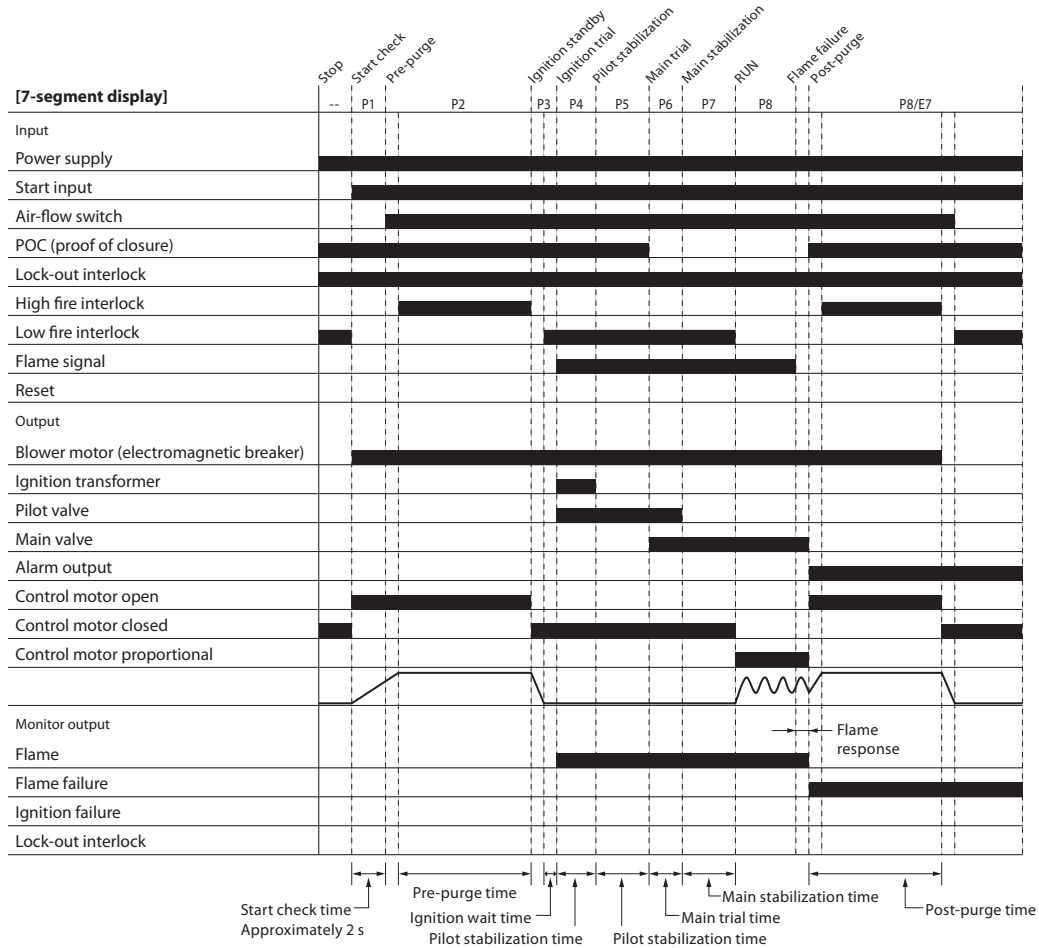

Input	Action	Sequence codes
Startup input ON	Start input is turned ON, followed by start check, ignition, and normal combustion.	P8
	If the flame is extinguished during normal combustion for some reason, the loss of flame is detected after the flame response time, and then K1, K2, and K4 are turned OFF, the main valve output is turned OFF, K6 is turned ON, and lock-out occurs. With regard to monitor output, flame failure output is generated. In that case, K10 remains ON, output for the blower motor continues until post-purge is complete, K8 is turned OFF, K7 is turned ON, and the control motor opening signal is output. After the post-purge time has elapsed, K7 is turned OFF, the control motor closure signal is output, K10 is turned OFF, and output for the blower motor is turned OFF. During post-purge, reset operation is not accepted.	P8/E7

● Flame failure

- Direct ignition type (with or without low fire shutdown)

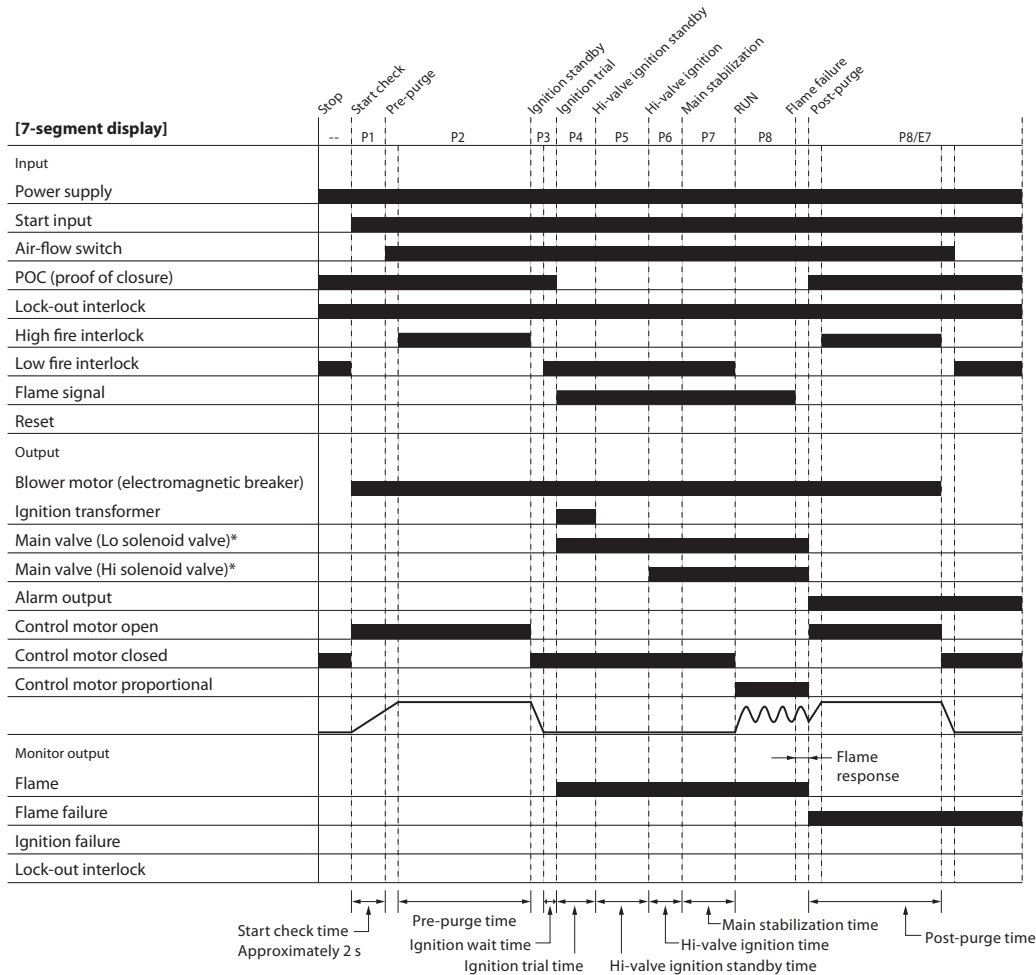

* Content in () describes the situation when three-position (Off-Lo-Hi) control is used. If other than three-position control is used, only look at the main valve (Lo-valve)

Input	Action	Sequence codes
Startup input ON	Start input is turned ON, followed by start check, ignition, and normal combustion.	P8
	If the flame is extinguished during normal combustion for some reason, the loss of flame is detected after the flame response time, K1, K2, K3, and K4 are turned OFF, Hi/Lo solenoid valves are turned OFF, K6 is turned ON, and lock-out occurs. With regard to monitor output, flame failure output is generated. In that case, K10 remains ON, output for the blower motor continues until post-purge is complete, K8 is turned OFF, K7 is turned ON, and the control motor opening signal is output. After the post-purge time has elapsed, K7 is turned OFF, the control motor closure signal is output, K10 is turned OFF, and output for the blower motor is turned OFF. During post-purge, reset operation is not accepted.	P8/E7

● Start input during post-purge

- Interrupted pilot type (without low fire shutdown)

Transition to pre-purge without checking that the air-flow switch is Off or stopping the blower.

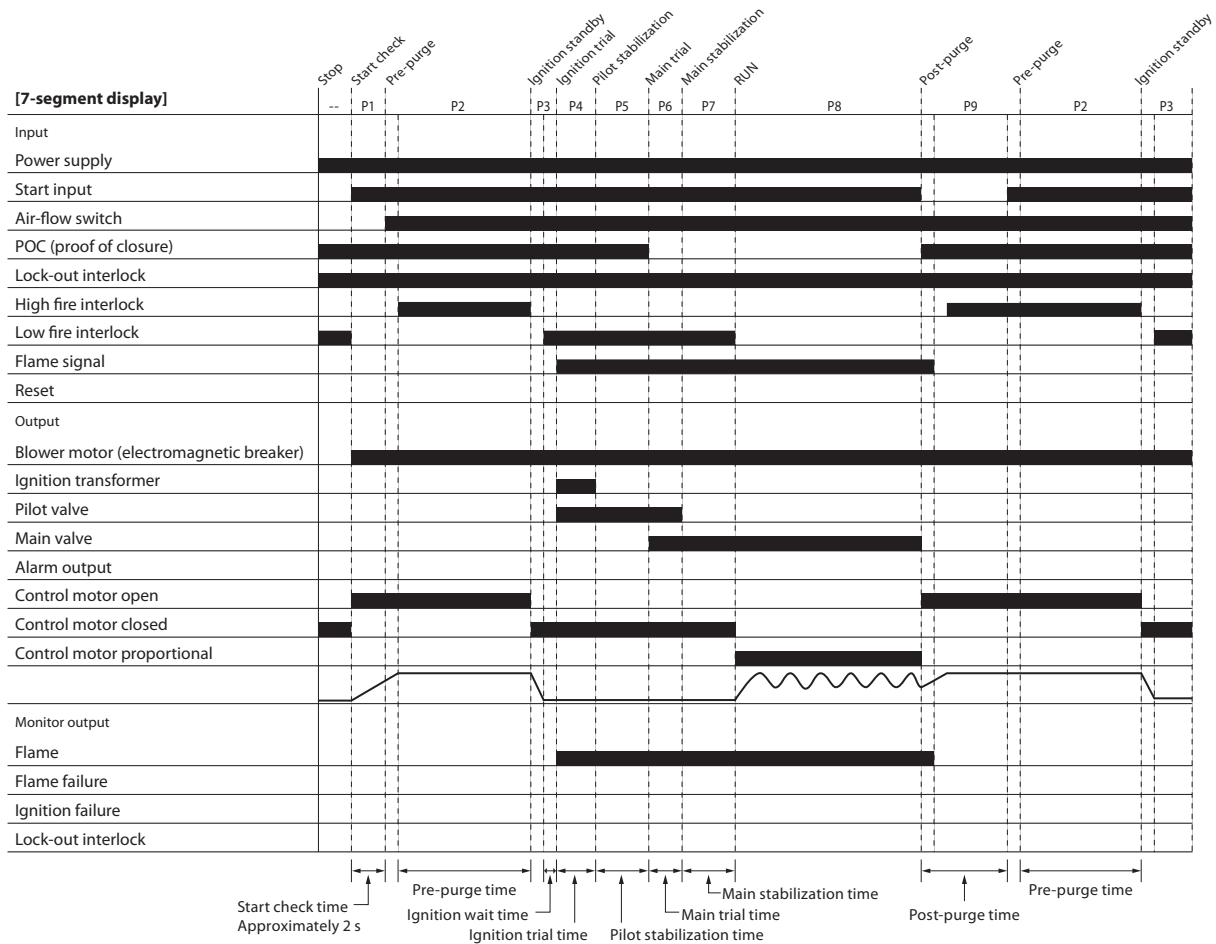

Input	Action	Sequence codes
Startup input ON	Start input is turned ON, followed by start check, ignition, and normal combustion.	P8
Startup input OFF	When the start input is turned OFF, K8 is turned OFF, K7 is turned ON, and the control motor opening signal is output. At the same time, K1, K2, and K4 are turned OFF and the main valve is turned OFF. K10 remains ON to keep the blower output ON, and timing of the post-purge begins.	P9
Startup input ON	If the start input is turned ON during post-purge, K10 remains ON, the air-flow switch is turned ON, high fire interlock is turned ON, and timing of the pre-purge begins. (In order to make sure the air-flow switch is OFF, K10 is turned OFF, and transition to the pre-purge sequence occurs without turning off the output for the blower motor.)	P2

● Start input during post-purge

- Direct ignition type (without low fire shutdown)

Transition to pre-purge without checking that the air-flow switch is Off or stopping the blower.

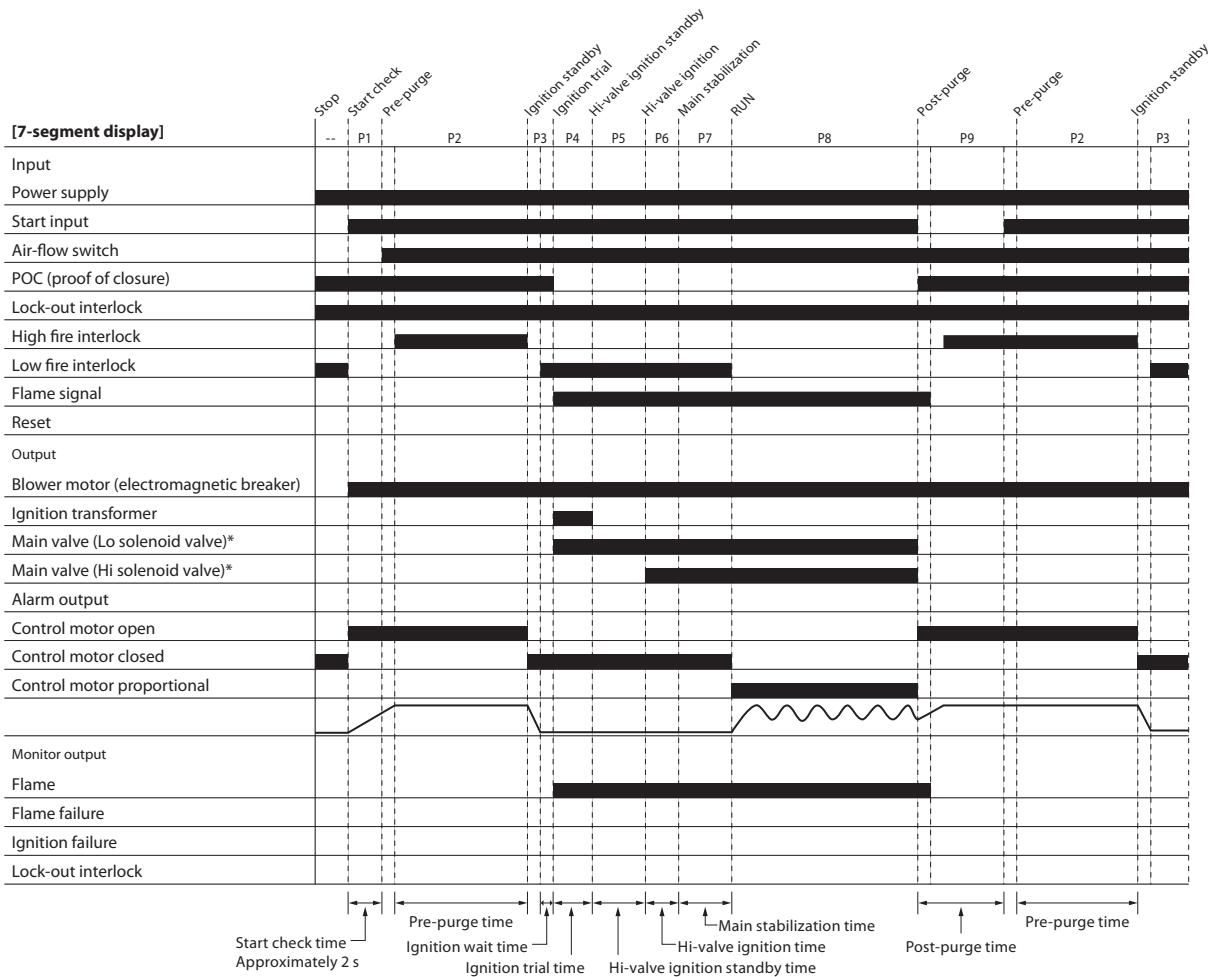

* Content in () describes the situation when three-position (Off-Lo-Hi) control is used. If other than three-position control is used, only look at the main valve (Lo-valve)

Input	Action	Sequence codes
Startup input ON	Start input is turned ON, followed by start check, ignition, and normal combustion.	P8
Startup input OFF	When the start input is turned OFF, K8 is turned OFF, K7 is turned ON, and the control motor opening signal is output. At the same time, K1, K2, K3, and K4 are turned OFF, and Hi/Lo solenoid valves are turned OFF. K10 remains ON to keep the blower output ON, and timing of the post-purge begins.	P9
Startup input ON	If the start input is turned ON during post-purge, K10 remains ON, the air-flow switch is turned ON, high fire interlock is turned ON, and timing of the pre-purge begins. (In order to make sure the air-flow switch is OFF, K10 is turned OFF, and transition to the pre-purge sequence occurs without turning off the output for the blower motor.)	P2

● **Interlock error**

- Interrupted pilot type (with or without low fire shutdown)

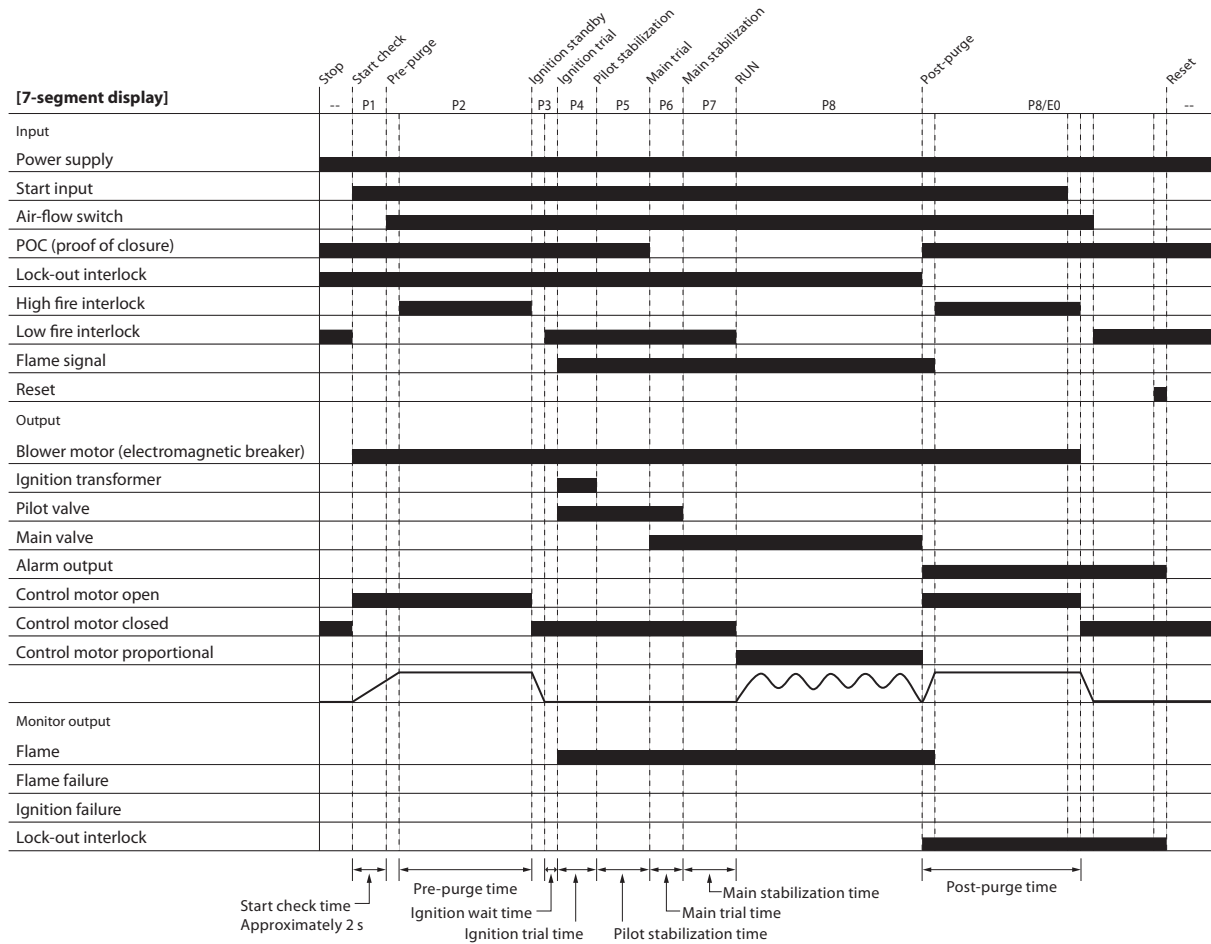

Input	Action	Sequence codes
Startup input ON	Start input is turned ON, followed by start check, ignition, and normal combustion.	<i>P8</i>
Lock-out interlock OFF	If the lock-out interlock is turned OFF during normal combustion, K1, K2, and K4 are turned OFF, main valve output is turned OFF, K6 is turned ON, and lock-out occurs. With regard to monitor output, lock-out interlock output is generated. In that case, K10 remains ON, output for the blower motor continues until post-purge is complete, K8 is turned OFF, K7 is turned ON, and the control motor opening signal is output. After the post-purge time has elapsed, K7 is turned OFF, the control motor closure signal is output, K10 is turned OFF, and output for the blower motor is turned OFF. During post-purge, reset operation is not accepted.	<i>P8/E0</i>
Contact reset or device reset switch: ON	After the post-purge time has elapsed, if the reset switch is pressed and held for approximately 1 second, the lock-out state is cleared and K6 is turned OFF.	-

● Interlock error

- Direct ignition type (with or without low fire shutdown)

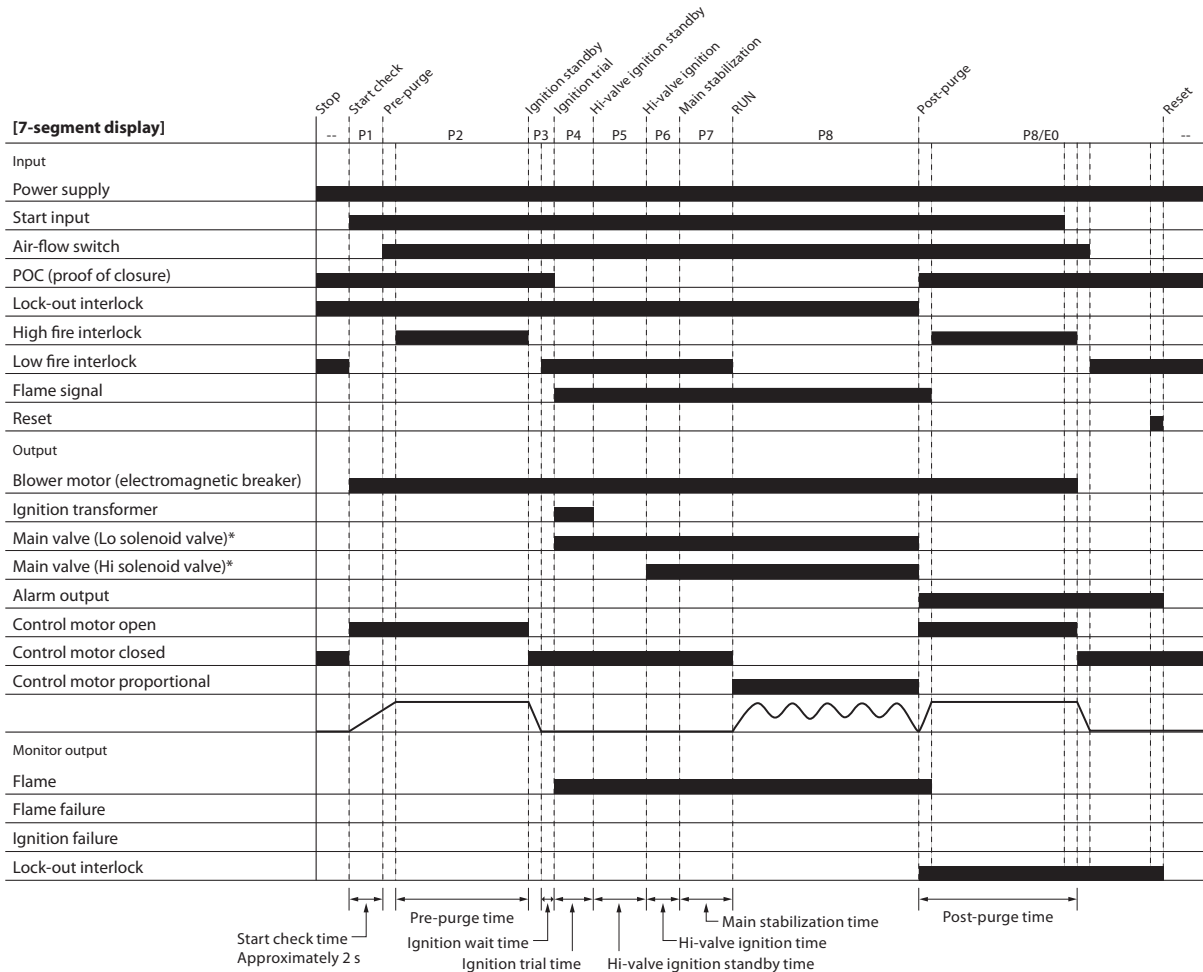

* Content in () describes the situation when three-position (Off-Lo-Hi) control is used.
 If other than three-position control is used, only look at the main valve (Lo-valve)

Input	Action	Sequence codes
Startup input ON	Start input is turned ON, followed by start check, ignition, and normal combustion.	P8
Lock-out interlock OFF	If the lock-out interlock is turned OFF during normal combustion, K1, K2, K3, and K4 are turned OFF, Hi/Lo solenoid valve output is turned OFF, K6 is turned ON, and lock-out occurs. With regard to monitor output, lock-out interlock output is generated. In that case, K10 remains ON, output for the blower motor continues until post-purge is complete, K8 is turned OFF, K7 is turned ON, and the control motor opening signal is output. After the post-purge time has elapsed, K7 is turned OFF, the control motor closure signal is output, K10 is turned OFF, and output for the blower motor is turned OFF. During post-purge, reset operation is not accepted.	P8/E0
Contact reset or device reset switch: ON	After the post-purge time has elapsed, if the reset switch is pressed and held for approximately 1 second, the lock-out state is cleared and K6 is turned OFF.	-

- The air-flow switch does not turn ON at the start of pre-purge.
 - Direct ignition type or interrupted pilot type (with or without low fire shutdown)

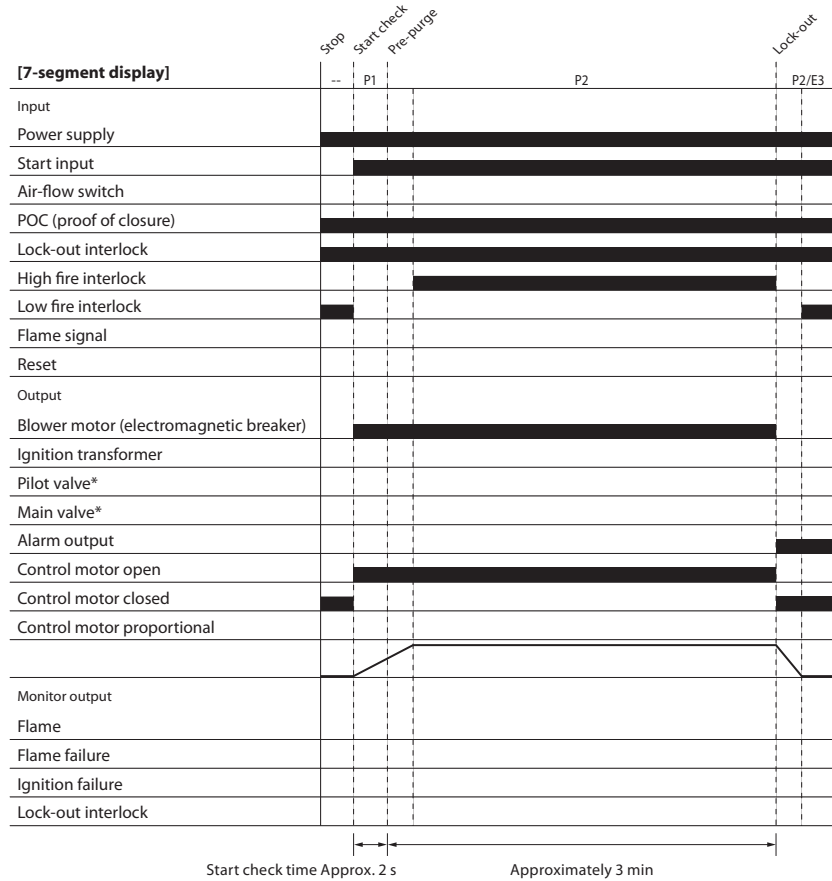

* In the case of direct ignition, the main valve (Lo-valve) and main valve (Hi-valve) are used.

Input	Action	Sequence codes
Startup input ON	When the start input is turned ON, K7 is turned ON and the control motor opening signal is output. When the air-flow switch is confirmed to be OFF, K10 is turned ON and output for the blower motor is turned ON. An internal circuit check is done to make sure that lock-out interlock is ON (normal), and that the shutoff valve proof of closure switch is ON (if the POC function is enabled).	P1
	The air-flow switch ON check is performed.	P2
	If the air-flow switch is not turned ON within 3 minutes, K6 is turned ON and lock-out occurs.	P2/E3

● The air-flow switch is ON at startup.

- Direct ignition type or interrupted pilot type (with or without low fire shutdown)

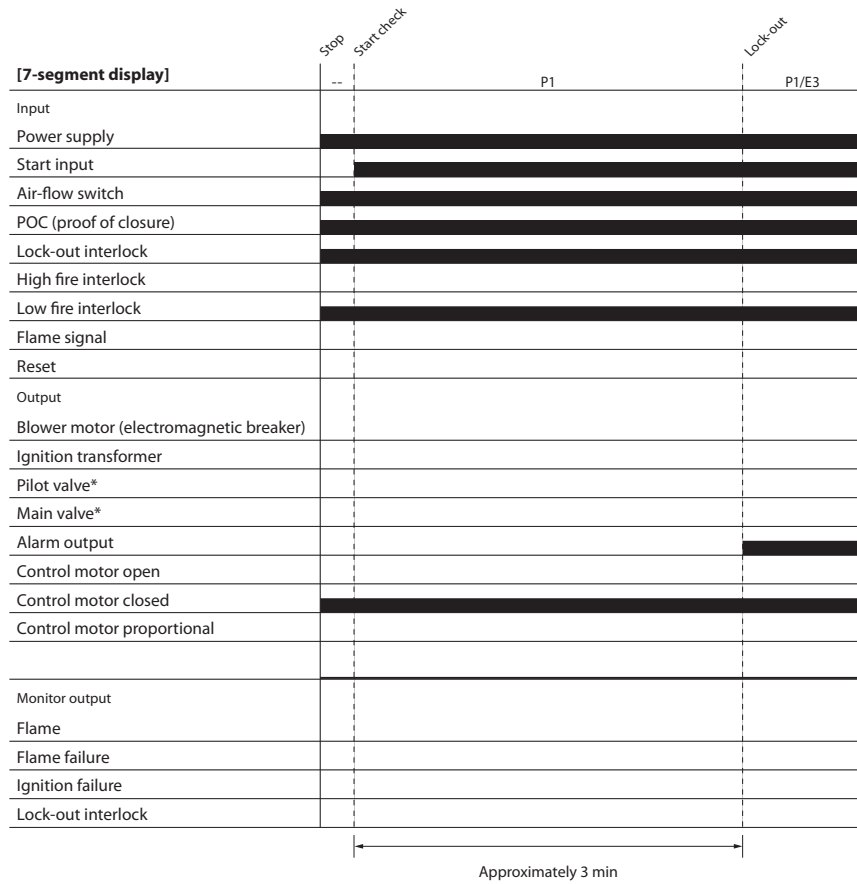

* In the case of direct ignition, the main valve (Lo-valve) and main valve (Hi-valve) are used.

Input	Action	Sequence codes
Startup input ON	When the start input is turned ON, the air-flow switch, lock-out interlock, and shutoff valve proof of closure are checked. Since the air-flow switch is ON, K7 and K10 are not ON, and the control motor closure signal continues to be output, so that output for the blower motor does not turn ON.	P1
	If the air-flow switch is not turned OFF within 3 minutes, K6 is turned ON and lock-out occurs.	P1/E3

● **Lock-out interlock is released before start input.**

- Direct ignition type or interrupted pilot type (with or without low fire shutdown)

[7-segment display]	Stop	Start check	Lock-out
	--	P1	P1/E0
Input			
Power supply			
Start input			
Air-flow switch			
POC (proof of closure)			
Lock-out interlock			
High fire interlock			
Low fire interlock			
Flame signal			
Reset			
Output			
Blower motor (electromagnetic breaker)			
Ignition transformer			
Pilot valve*			
Main valve*			
Alarm output			
Control motor open			
Control motor closed			
Control motor proportional			
Monitor output			
Flame			
Flame failure			
Ignition failure			
Lock-out interlock			

* In the case of direct ignition, the main valve (Lo-valve) and main valve (Hi-valve) are used.

Input	Action	Sequence codes
Startup input ON	When the start input is turned ON, the air-flow switch, lock-out interlock, and shutoff valve proof of closure input are checked.	<i>P1</i>
	If lock-out interlock ON (normal) cannot be confirmed, K6 is turned ON and lock-out occurs. At this time, K7 remains OFF, and the control motor closure signal is output. Monitor output lock-out interlock is turned ON.	<i>P1/E0</i>

● Start input during low fire shutdown

- Interrupted pilot type (with low fire shutdown)

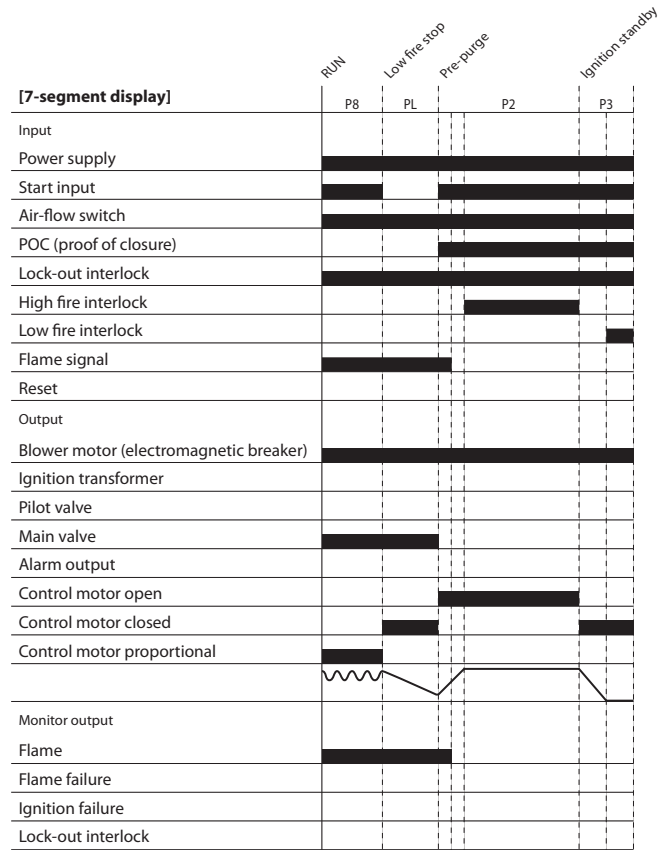

Input	Action	Sequence codes
Startup input ON	Start input is turned ON, followed by start check, ignition, and normal combustion.	P8
Startup input OFF	When the start input is turned OFF, K8 is turned OFF and the control motor closure signal is output. Under those conditions the low fire shutdown time is then counted down.	PL
Startup input ON	When the start input is turned ON again during low fire, K1, K2, and K4 are turned OFF, and the main valve is turned OFF. At the same time, K7 is turned ON, and the control motor opening signal is output. The air-flow switch remains ON, so the system is on standby until the high fire interlock turns ON and the flame signal disappears. Then timing of the pre-purge begins.	P2
	When the pre-purge time has elapsed, K7 is turned OFF, the control motor closure signal is output, and low fire interlock is confirmed to be ON.	P3

● **Start input during low fire shutdown**
 • Direct ignition type (with low fire shutdown)

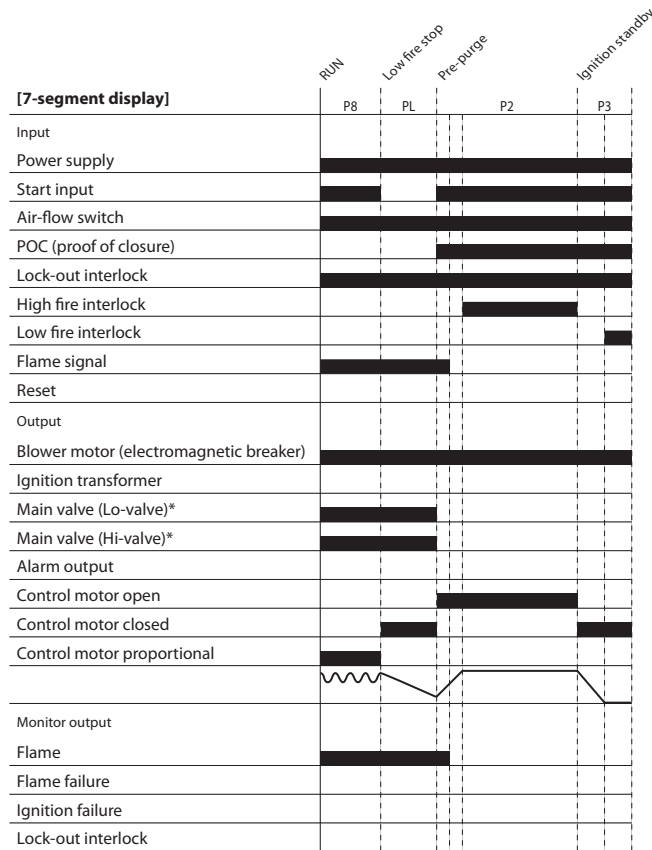

* Content in () describes the situation when three-position (Off-Lo-Hi) control is used. If other than three-position control is used, only look at the main valve (Lo-valve)

Input	Action	Sequence codes
Startup input ON	Start input is turned ON, followed by start check, ignition, and normal combustion.	P8
Startup input OFF	When the start input is turned OFF, K8 is turned OFF and the control motor closure signal is output. Under those conditions the low fire shutdown time is then counted down.	PL
Startup input ON	When the start input is turned ON again during low fire, K1, K2, K3, and K4 are turned OFF, and the Lo solenoid valve and Hi solenoid valve are turned OFF. At the same time, K7 is turned ON, and the control motor opening signal is output. The air-flow switch remains ON, so the system is on standby until the high fire interlock turns ON and the flame signal disappears. Then timing of the pre-purge begins.	P2
	When the pre-purge time has elapsed, K7 is turned OFF, the control motor closure signal is output, and low fire interlock is confirmed to be ON.	P3

● False flame during pre-purge

- Interrupted pilot type or direct ignition type

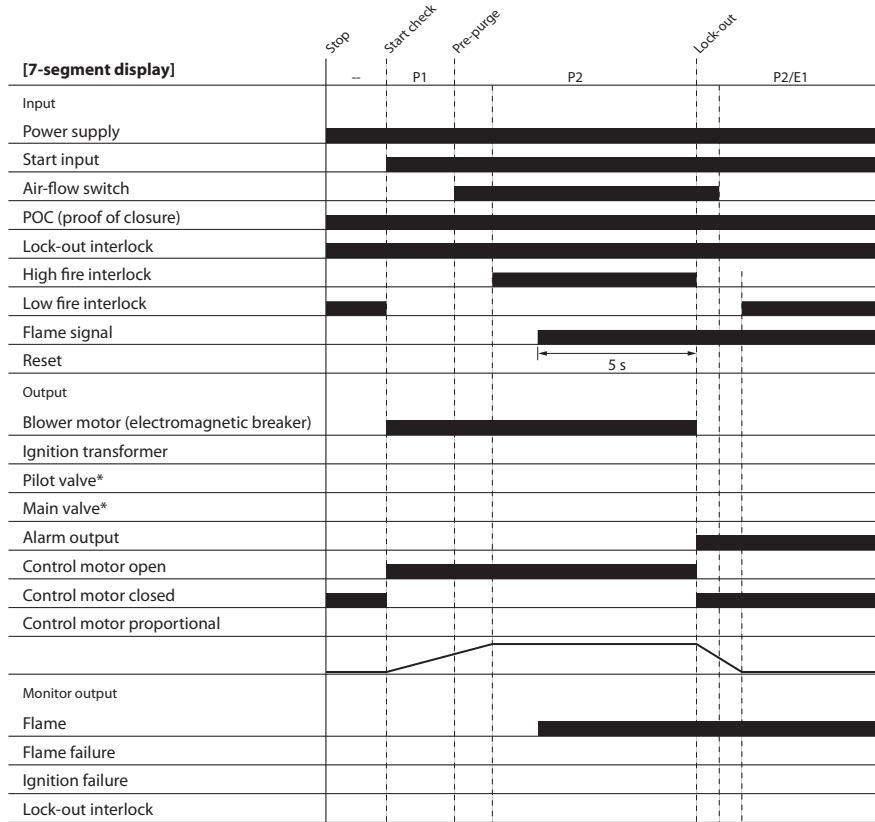

* In the case of direct ignition, the main valve (Lo-valve) and main valve (Hi-valve) are used.

Input	Action	Sequence codes
Startup input ON	When the start input is turned ON, the internal circuits are checked, and also checks are done to make sure that lock-out interlock is ON (normal), that the shutoff valve proof of closure switch is ON (POC function enabled), and that the air-flow switch is OFF.	P1
	K10 is turned ON, output for the blower motor is turned ON, and the air-flow switch ON check is performed.	P2
	A false flame is detected during the pre-purge sequence. After the false flame state continues for 5 seconds, K6 is turned ON and lock-out occurs. K7 is turned OFF, the control motor closure signal is output, K10 is turned OFF, and output for the blower motor is turned OFF.	P2/E1

- **False flame occurs before start, and start input is turned ON.**
 - Interrupted pilot type or direct ignition type

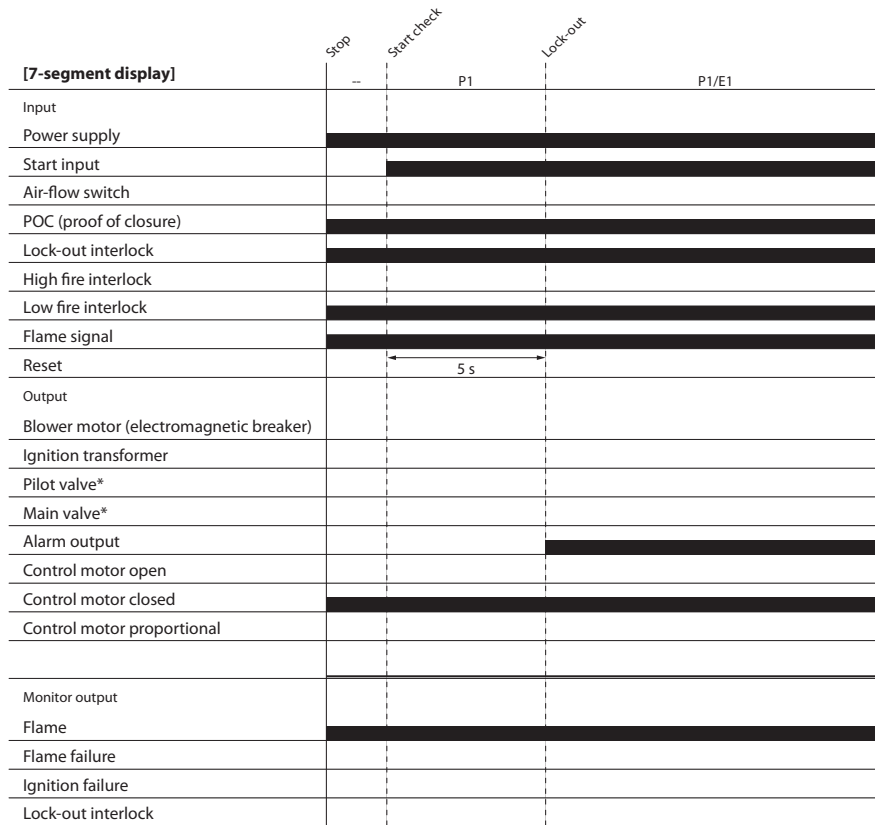

* In the case of direct ignition, the main valve (Lo-valve) and main valve (Hi-valve) are used.

Input	Action	Sequence codes
After the power is turned ON, a false flame is detected.	During the stop sequence, a false flame is detected.	-
Startup input ON	After the start input is turned ON, the false flame is monitored. The start check part of the sequence continues. K7 remains OFF, the control motor closure signal is output, and K10 remains OFF.	P1
	After the false flame state continues for 5 seconds, K6 is turned ON and lock-out occurs.	P1/E1

● Flame lost during low fire
 • Interrupted pilot type

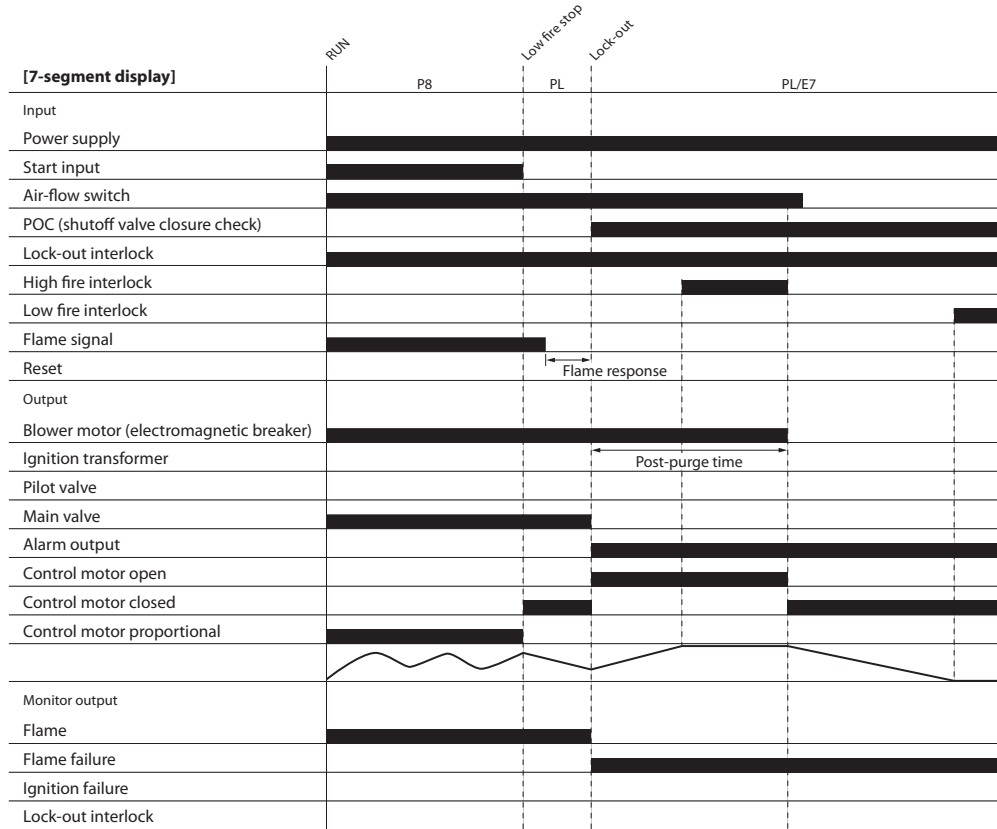

Input	Action	Sequence codes
Startup input ON	Start input is turned ON, followed by start check, ignition, and normal combustion.	P8
Startup input OFF	When the start input is turned OFF, K8 is turned OFF and the control motor closure signal is output. Under those conditions the low fire shutdown time is then counted down.	PL
	If the flame is extinguished during low fire for some reason, the loss of flame is detected after the flame response time, and then K1, K2, and K4 are turned OFF, the main valve output is turned OFF, K6 is turned ON, and lock-out occurs. With regard to monitor output, flame failure output is generated. In that case, K10 remains ON, output for the blower motor continues until post-purge is complete, K7 is turned ON, and the control motor opening signal is output. After the post-purge time has elapsed, K7 is turned OFF, the control motor closure signal is output, K10 is turned OFF, and output for the blower motor is turned OFF. During post-purge, reset operation is not accepted.	PL/E7

Note: If some other error (interlock error, POC error, air-flow switch error 1) occurs during low fire shutdown, post-purge is performed in the same way as for flame failure, and the process is stopped.

● Flame lost during low fire

- Direct ignition type

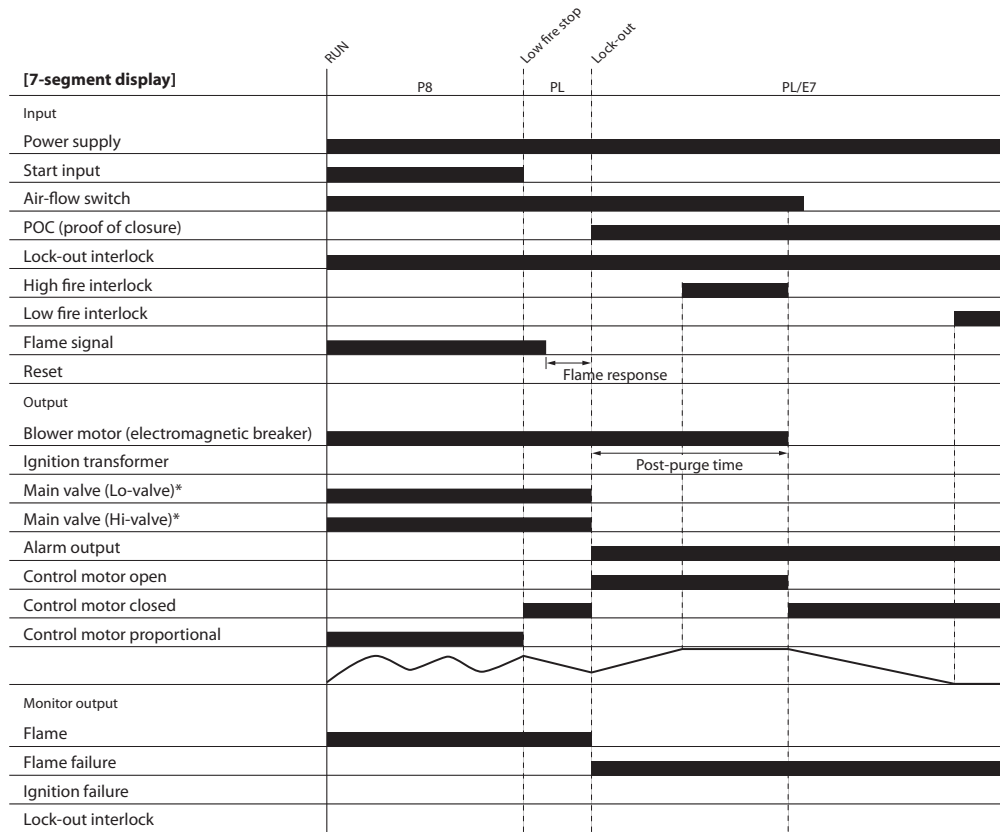

* Content in () describes the situation when three-position (Off-Lo-Hi) control is used. If other than three-position control is used, only look at the main valve (Lo-valve)

Input	Action	Sequence codes
Startup input ON	Start input is turned ON, followed by start check, ignition, and normal combustion.	P8
Startup input OFF	When the start input is turned OFF, K8 is turned OFF and the control motor closure signal is output. Under those conditions the low fire shutdown time is then counted down.	PL
	If the flame is extinguished during low fire shutdown for some reason, the loss of flame is detected after the flame response time, K1, K2, K3, K4 are turned OFF, Hi/Lo solenoid valve output is turned OFF, K6 is turned ON, and lock-out occurs. With regard to monitor output, flame failure output is generated. In that case, K10 remains ON, output for the blower motor continues until post-purge is complete, K7 is turned ON, and the control motor opening signal is output. After the post-purge time has elapsed, K7 is turned OFF, the control motor closure signal is output, K10 is turned OFF, and output for the blower motor is turned OFF. During post-purge, reset operation is not accepted.	PL/E7

Note: If some other error (interlock error, POC error, air-flow switch error 1) occurs during low fire shutdown, post-purge is performed in the same way as for flame failure, and the process is stopped.

● The low fire interlock turned off between pilot ignition and main stabilization

- Interrupted pilot type

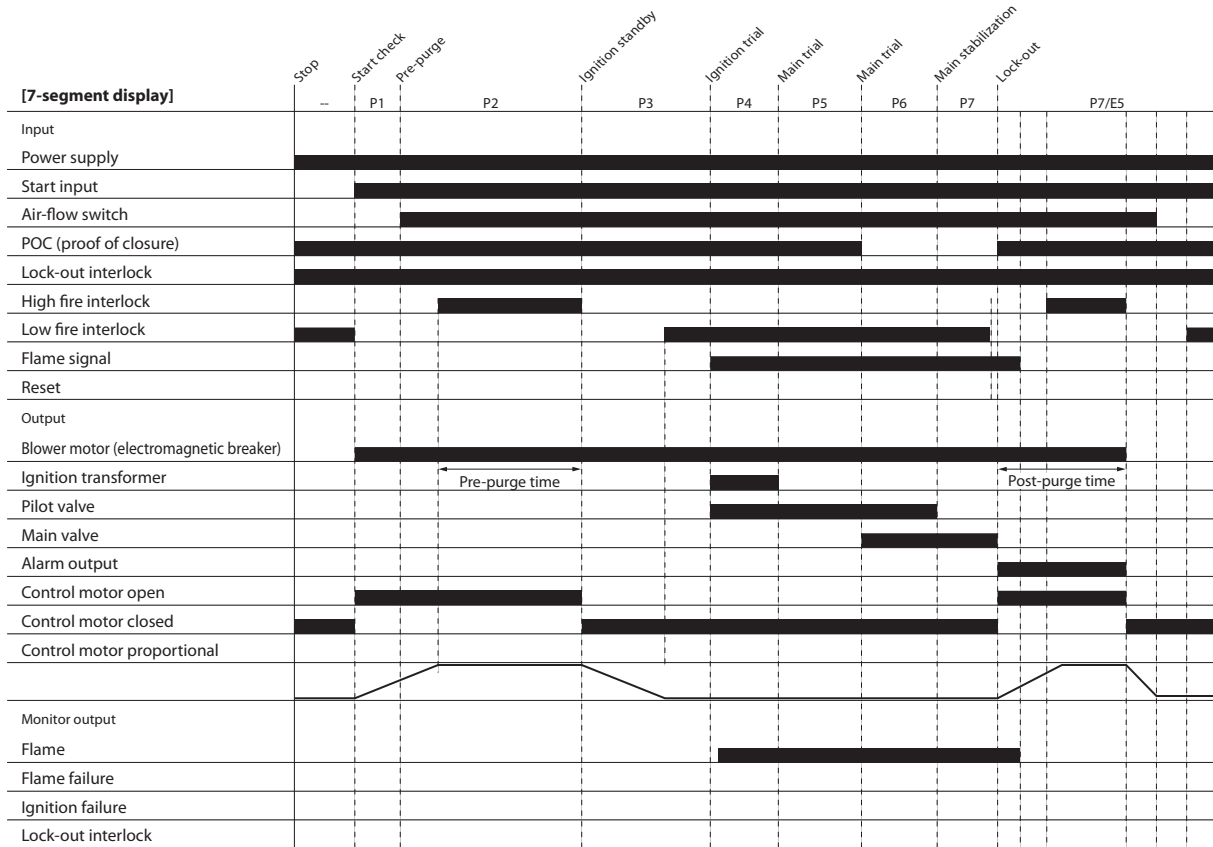

Input	Action	Sequence codes
Startup input ON	Start input is turned ON, followed by start check and ignition, and then pre-purge ends.	P2
	When the pre-purge time has elapsed, K7 is turned OFF, the control motor closure signal is output, and low fire interlock is confirmed to be ON.	P3
	After low fire interlock ON is confirmed, K3 and K5 are turned ON, and output is sent to the ignition transformer and pilot valve.	P4
	If a flame signal can be detected, K5 is turned OFF when the pilot ignition time has elapsed, and the ignition transformer is turned OFF.	P5
	K4 is turned ON and the main valve is turned ON. Within 3 seconds after the main valve is turned ON a check is done to make sure that the shutoff valve proof of closure switch is OFF (if the POC function is enabled).	P6
	When main burner ignition is completed, K3 is turned OFF, the pilot valve is turned OFF, and main burner ignition status is maintained until the main flame stabilization time has elapsed.	P7
	If low fire interlock is turned OFF during main flame stabilization, K1, K2, and K4 are turned OFF, main valve output is turned OFF, K6 is turned ON, and lock-out occurs. In that case, K10 remains ON, output for the blower motor continues until post-purge is complete, K7 is turned ON, and the control motor opening signal is output. After the post-purge time has elapsed, K7 is turned OFF, the control motor closure signal is output, K10 is turned OFF, and output for the blower motor is turned OFF. During post-purge, reset operation is not accepted.	P7/E5

Note: The low fire interlock is turned off between pilot ignition and main flame stabilization, and lock-out occurs.

● The low fire interlock turned off between pilot ignition and main stabilization
 • Direct ignition type

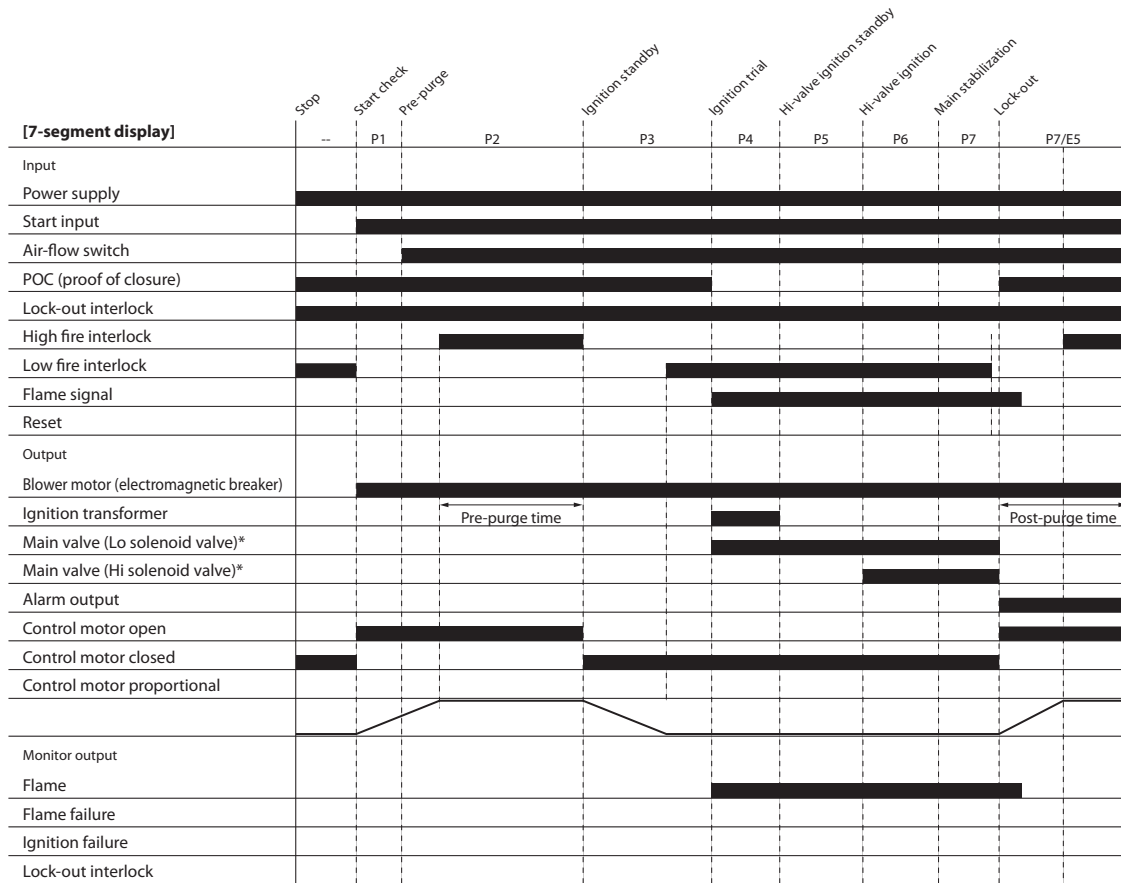

* Content in () describes the situation when three-position (Off-Lo-Hi) control is used.
 If other than three-position control is used, only look at the main valve (Lo-valve)

Input	Action	Sequence codes
Startup input ON	Start input is turned ON, followed by start check and ignition, and then pre-purge ends.	P2
	When the pre-purge time has elapsed, K7 is turned OFF, the control motor closure signal is output, and low fire interlock is confirmed to be ON.	P3
	After low fire interlock is confirmed ON, K3 and K5 are turned ON and output is sent to the ignition transformer and Lo solenoid valve. Within 3 seconds after the Lo solenoid valve is turned ON, a check is done to make sure that the shutoff valve proof of closure switch is OFF (if the POC function is enabled).	P4
	If a flame signal can be detected, K5 is turned OFF when the ignition time elapses, and the ignition transformer is turned OFF.	P5
	K4 is turned ON and Hi solenoid valve is turned ON.	P6
	The Hi solenoid valve ignition status is maintained until the main flame stabilization time has elapsed.	P7
	If low fire interlock is turned OFF during main flame stabilization, K1, K2, K3, and K4 are turned OFF, Hi/Lo solenoid valve output is turned OFF, K6 is turned ON, and lock-out occurs. In that case, K10 remains ON, output for the blower motor continues until post-purge is complete, K7 is turned ON, and the control motor opening signal is output. After the post-purge time has elapsed, K7 is turned OFF, the control motor closure signal is output, K10 is turned OFF, and output for the blower motor is turned OFF. During post-purge, reset operation is not accepted.	P7/E5

Note: The low fire interlock is turned off between pilot ignition and main flame stabilization, and lock-out occurs.

- High fire interlock does not turn ON during pre-purge
 - Interrupted pilot type or direct ignition type

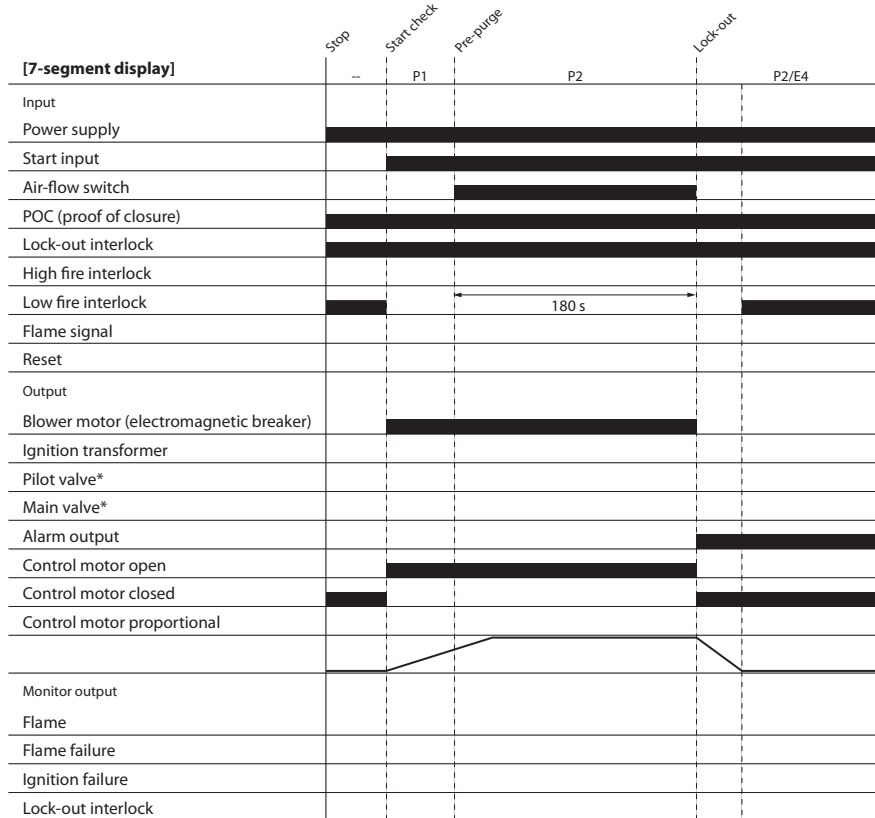

* In the case of direct ignition, the main valve (Lo-valve) and main valve (Hi-valve) are used.

Input	Action	Sequence codes
Startup input ON	When the start input is turned ON, K7 is turned ON, the control motor opening signal is output, the internal circuits are checked, and also checks are done to make sure that lock-out interlock is ON (normal), that the shutoff valve proof of closure switch is ON (if the POC function is enabled), and that the air-flow switch is OFF.	P1
	K10 is turned ON, output for the blower motor is turned ON, and checks are done to make sure that the air-flow switch is ON and that the high fire interlock is ON.	P2
	If the high fire interlock is not turned ON during the pre-purge sequence, and three minutes elapse, K6 is turned ON and lock-out occurs. K7 is turned OFF, the control motor closure signal is output, K10 is turned OFF, and output for the blower motor is turned OFF.	P2/E4

- **Low fire interlock will not turn ON during low fire standby.**
 - Interrupted pilot type or direct ignition type

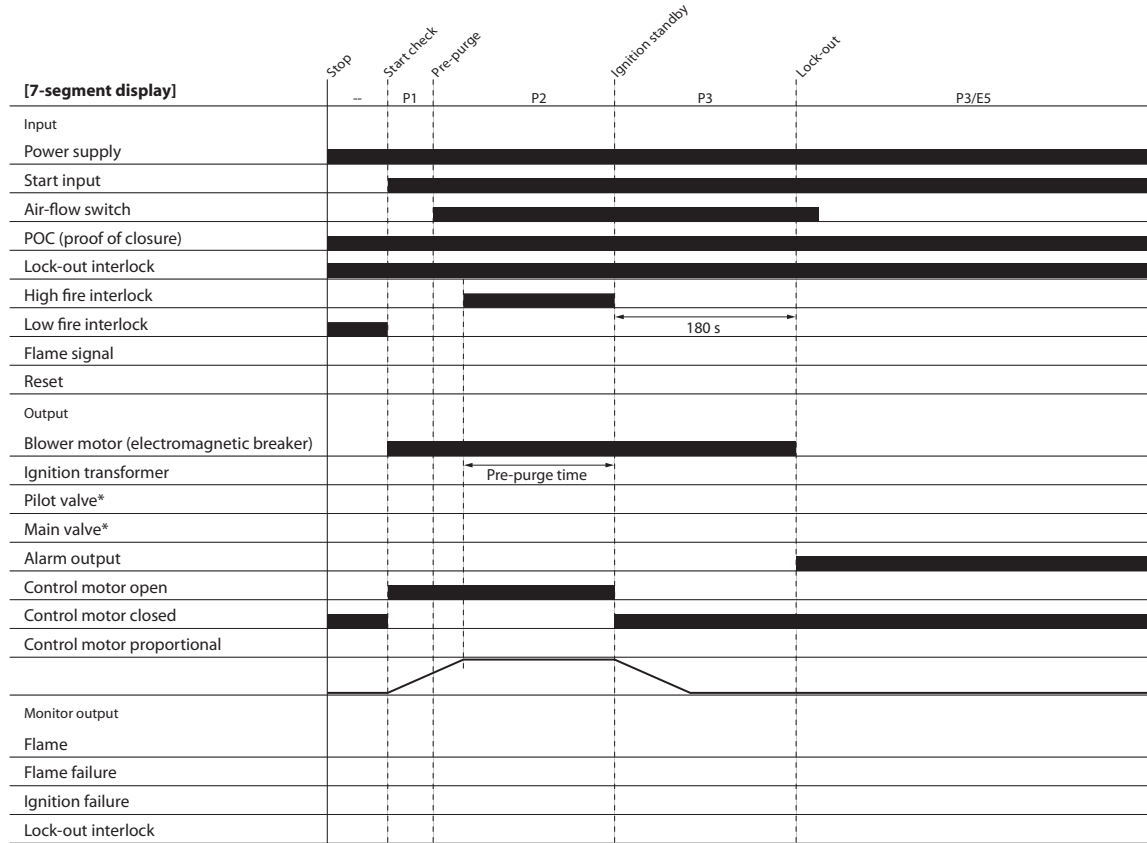

* In the case of direct ignition, the main valve (Lo-valve) and main valve (Hi-valve) are used.

Input	Action	Sequence codes
Startup input ON	Start input is turned ON, followed by start check and ignition, and then pre-purge ends.	P2
	When the pre-purge time has elapsed, K7 is turned OFF, the control motor closure signal is output, and low fire interlock is monitored.	P3
	If low fire interlock remains OFF for three minutes, K6 is turned ON and lock-out occurs. K7 remains OFF, the control motor closure signal is output, K10 is turned OFF, and output for the blower motor is turned OFF.	P3/E5

■ Alarm and occurrence sequence

Name	Symbol	Interlock Error	False flame Error	Air-flow Switch Error 1	Air-flow Switch Error 2	High fire Interlock Error	Low fire Interlock Error [1][2]	Ignition failure	Flame failure	POC (proof of closure) error
		E0	E1	E2	E3	E4	E5	E6	E7	E8
Stop	--									
Start check	P1	○	○		○					○
Pre-purge	P2	○	○		○	○				○
Ignition standby	P3	○	○	○			○			○
Ignition trial	P4	○		○			○	○		○
Pilot stabilization/ Hi-valve ignition standby	P5	○		○			○		○	○
Main trial/ Hi-valve ignition	P6	○		○			○		○	○
Main stabilization	P7	○		○			○		○	○
RUN	P8	○		○					○	○
Post-purge	P9									
Low fire stop	PL	○		○					○	○

Explanation of symbols in the table







Blank: Not monitored

○: Monitored



* Moves to P2 if there is a false flame.

Chapter 5. Trial Operation and Adjustment

WARNING

-  Trial operation and adjustment include burner startup and motor startup, which may result in physical injury. Make sure that those performing equipment adjustment tasks take adequate safety precautions.
-  Make sure that the ignition times for the pilot and main burners do not exceed the ignition times specified by the burner or device manufacturer. Excessive ignition times may cause fuel to accumulate in the combustion chamber and form an explosive fuel-air mixture, which can result in a serious explosion hazard.
-  Do not touch the terminal area during trial operation and adjustment. Doing so may result in an electric shock.
-  Terminal 14 (F) retains an electrical charge even after the power is turned off. Do not touch terminal F even after turning the power off. Doing so may result in an electric shock.
-  Do not operate this device without first completing calibration, testing, and combustion equipment manufacturer's tests.
-  If lock-out occurs, make sure to execute a pre-purge before restarting. If unburned gas is not expelled from the combustion chamber and flue, there is a risk of an explosion during ignition.

CAUTION

-  Mounting, wiring, maintenance, inspection, calibration, etc. should be carried out by a professional with technical training in combustion systems and combustion safety devices.
-  The pilot turn-down test should be carried out by an experienced specialist possessing knowledge and skills pertaining to combustion equipment and combustion safety.

■ Preliminary inspection

- (1) The temperature and humidity are within the ranges specified for operating conditions.
- (2) There are no errors in wiring and terminal screws are not loose.
- (3) The flame detector is installed correctly. (For the installation location, orientation, and other details, see the user's manual for the flame detector.)
- (4) The burner is adjusted correctly.
- (5) There are no obstructions, covers, or other items in the combustion air intake or exhaust outlet.
- (6) The supply voltage is the same as shown on the device.

■ Inspection procedure

For safe operation of the combustion equipment, inspect the following items carefully and make appropriate adjustments.

WARNING

-  When operating the device in trial operation mode, there is a danger of injury from motor operation, etc. Please take adequate safety precautions before starting this mode.

■ **Control motor adjustment, air pressure switch adjustment**

When starting trial operation mode, blower motor output or control motor output may be generated.

- (1) When the blower motor is OFF, the air damper assembly can be adjusted while putting the control motor in the closed and open positions.

Trial operation display	Blower motor output	Control motor output
Ⓒ9	OFF	Close
ⒸA	OFF	Open
Ⓒb	OFF	Proportioning

Also, when using our SDC35/36 position proportioning controller, if it is connected to the control motor, with "Ⓒb" as the BC-R35 trial operation display, and with the control motor output set to "Proportion," the necessary first adjustment, "auto-tuning for position proportional control," can be performed.

- (2) When the blower motor is ON, the control motor can be changed to the minimum fire position and maximum fire position, changing the air pressure, and the air-flow switch setting can be adjusted.

Also, by means of proportional control motor output, with the controller in manual mode, the control motor's opening can be changed, changing the air pressure, so that the air-flow switch setting can be adjusted.

Trial operation display	Blower motor output	Control motor outputs
Ⓒ6	ON	Close
Ⓒ7	ON	Open
Ⓒ8	ON	Proportioning

■ Ignition spark response (UV sensor)

 **WARNING**



Ensure that the UV sensor does not detect ultraviolet rays other than those from the burner. If the UV sensor responds to other ultraviolet radiation, fuel will continue to be supplied even if the burner flame is off, potentially causing an explosion.



Before doing the spark response test, always make sure that all manual fuel valves are closed.

- (1) Close the manual valves in the piping for the pilot and main burners.
- (2) Begin operation and measure the flame voltage during the pilot ignition sequence to check for any effect from the ignition spark.
- (3) If the spark has an effect, such as causing the FLAME LED to light up, refer to the user's manual for the equipment and make adjustments in the following way.
 - Move the UV sensor or the ignition spark rod so that the spark does not affect the flame voltage.
 - Attach a shield that prevents the spark's ultraviolet radiation from entering the optical path of the UV sensor. Adjust so that the spark's effect on the flame signal is 0.4 Vdc or less.
 - In the case of a solid-state power semi-terminal drive igniter (S7200AxxxGHx or S720AxxxGHx), swap the polarity of the power to the igniter. When this device is used in combination with a half-wave drive igniter, changing the polarity of the power can prevent the UV sensor's detection of the spark.

 **Handling Precautions**

- Ensure that the UV sensor does not detect ultraviolet rays other than those from the burner flame.

Sources of ultraviolet radiation (other than the burner flame) that can activate the UV sensor include the following.

Examples:

Ultraviolet ray sources	1371 °C or hotter red-hot furnace wall (within 50 cm from wall)
	Ignition transformer, welding arc spark
	Gas laser
	Sun lamp
	Germicidal lamp, ultraviolet lamp, fluorescent lamp
	Strong flashlight (towards UV phototube)
Gamma ray and X-ray sources	X-ray analyzer, gamma ray analyzer/measurer
	Electron microscope
	X-ray machine
	High-voltage vacuum switch
	High-voltage capacitor
	Radioactive isotope
	Any other ultraviolet, gamma, or X-ray source

■ Measurement of flame voltage

This device shows the flame voltage on the 7-segment display. It can be checked by changing the display using the DISP switch on the front of the device.

Checking the flame voltage is the best way to determine whether or not the location of the flame detector is appropriate.

It should be checked during installation and servicing.

Checking it once per month or more can prevent shutdowns due to insufficient flame voltage.

Start the device and measure the voltage under various conditions, such as at start-up and during normal operation.

Check to make sure that the flame voltage remains stable at 2.0 Vdc or more. The recommended flame voltage is 2.0 Vdc or more and it must be stable.

* If this stable voltage cannot be achieved, the problem may be caused by one or more of the following. In such a case, do a thorough inspection.

- (1) The power supply voltage or frequency is not correct.
- (2) The air supply pressure or air-fuel ratio is not correct.
- (3) The flame detector is not correctly wired.
 - Open circuit
 - Short circuit
 - High-resistance short circuit of the lead wires due to the temperature or dirt
- (4) Incorrect flame monitoring direction (BC-R35A/C)
- (5) Dirty flame sensor surface (BC-R35A/C)
- (6) AUD15C tube unit deterioration (BC-R35C).
- (7) Incorrect flame rod installation (BC-R35B).
 - Area in contact with flame is insufficient.
 - Position of flame rod in flame is incorrect.
 - The flame rod insulator is at a high temperature (315 °C).
 - Flame rod is affected by ignition transformer.

If the ignition transformer is placed close to Terminal F of the flame rod, electrons in the flame are absorbed into the ignition transformer, and as a result, sufficient flame voltage cannot be achieved.

(Ref.) Illuminance and Flame Output Characteristics

● BC-R35A (AFD100 series)

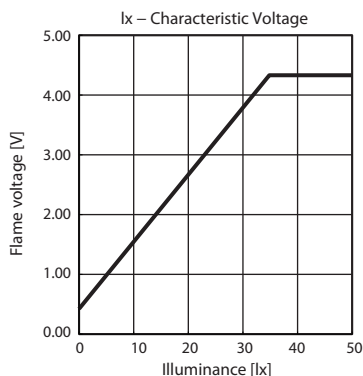

(Ref.) Correlation of flame output with that of older model

● BC-R35C (AUD100/110/120)

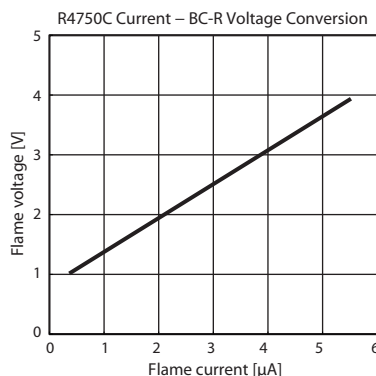

● BC-R35B (flame rod)

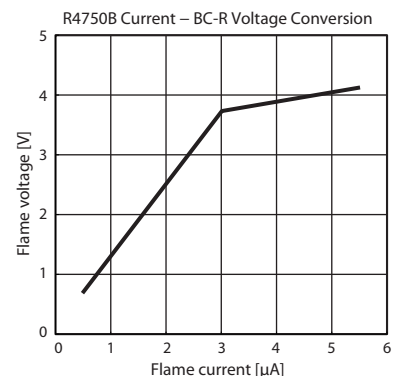

● Measurement method for flame voltage

The voltage can be checked on the 7-segment display or by connecting a flame meter to terminals 25 and 26 of the front connector.

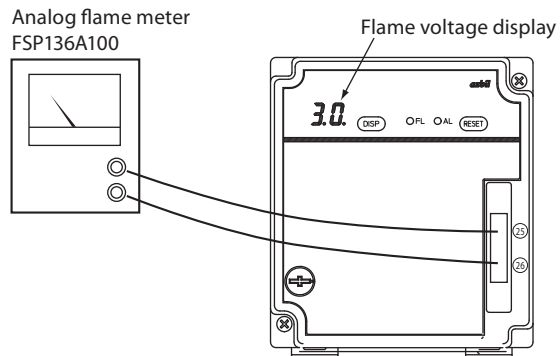





* Connector for front wiring (81447514-001/002) is required to connect FSP136A100 to BC-R35 series.

! Handling Precautions

- For flame voltage output signal wires, use wire with indoor PVC insulation ("IV wire," JIS C3307) 0.75 mm². Wiring length cannot be more than 10 m.
- The input impedance of a measuring instrument used with this device must be 100 k Ω or more.

■ Pilot turn-down test

 **WARNING**

-  Make sure that the pilot turn-down test is done properly. If the flame detector is able to detect a pilot flame that is too small to ignite the main burner, and if there is a flame failure of the main burner, this device will not be able to recognize the flame failure. As a result, fuel will continue to be supplied, resulting in an explosion hazard.
-  Before doing the pilot turn-down test, always make sure that all manual fuel valves are closed.
-  If the pilot turn-down test must be repeated, stop the combustion equipment completely each time and discharge all of the unburned gas and oil from the fuel chamber and flue. Failure to discharge unburned gas may result in an explosion hazard.
-  After completing the pilot turn-down test, turn off the power switch to turn off the power supply. Make sure to return all test jumpers and limit or controller settings to their original values. Resuming normal operation without returning the settings to their original values, etc., may damage the equipment or cause a gas leak or explosion.

 **CAUTION**

-  The pilot turn-down test should be carried out by an experienced specialist possessing knowledge and skills pertaining to combustion equipment and combustion safety.

The purpose of this test is to determine the smallest possible pilot flame that will reliably ignite the main burner.

Before and after this test, make sure to measure the flame voltage and confirm that it is 2.0 V or more. This device has a trial operation mode. If pilot turn-down is selected in the trial operation mode, the device does not move to main combustion, but instead continues with pilot combustion. When the trial operation mode is used, the pilot turn-down test can be executed by turning on and off the start input. For instructions on starting trial operation mode, see chapter 3.

- (1) Turn off the power switch and stop all the equipment.
- (2) Close the main valve (by removing one side of the wiring to the main valve or by closing the manual cock) to cut off the gas to the main burner. The pilot valve remains in its normal state.
- (3) Turn on the power switch. If the start input is on, the ignition sequence begins after the pre-purge, as soon as the pilot valve is opened.
- (4) After the pilot burner ignites, turn the pilot valve (manual cock) down until the burner controller extinguishes the flame. Mark the position of the manual cock at the time when the flame is extinguished. Then, press the reset switch to reset the error and restart it. Turn the manual cock back until just before the previously marked position (so that more gas is output).

● **Key Point**

When the trial operation mode is used, the pilot burner combustion continues and there is no limitation on the pilot ignition time. Therefore, it is easy to check.

- (5) Turn off the power switch, return the main valve to the normal state and then turn on the power switch again. After the pre-purge, pilot burner combustion begins and then main burner combustion begins.

If the main burner does not ignite, turn off the power switch immediately.

The pilot flame is too small, so it must be increased. In that case, correct the installation location of the flame detector so that the monitoring angle of the flame detector is slightly away from the pilot flame monitoring axis.

Handling Precautions

- If it is necessary to repeat the test, each time it is repeated be sure to stop all the equipment first to prevent an explosion and then discharge all unburned gas that has accumulated in the combustion chamber and exhaust flue.
 - Also when executing the pilot turn-down test using the trial operation mode, where there is a risk because the main valve is on, force the gas to be cut off by using the manual cock or disconnecting the wiring.
- (6) Change the gas pressure from the minimum to the maximum and repeat steps (1) to (5) to check if the main burner ignites properly.

■ Safety shutoff check

(1) Interlock check

While the burner is operating, simulate the operation of each interlock and check if lock-out or shutdown occurs.

After checking, return the settings to their original values and restart the burner to check that it ignites normally.

(2) Pilot ignition failure check

Close the manual gas cock. Turn on the start input of the burner to begin operation. After the pre-purge, an attempt is made to ignite the pilot burner. Since the manual cock is closed, however, the pilot burner does not ignite and lock-out occurs.

After confirming the above behavior, open the manual cock. Turn on the reset switch, restart the burner and check if it ignites normally.

(3) Flame failure check

Close the manual gas cock while the burner is operating. After the flame response time elapses, the pilot valve and main valve close and lock-out occurs.

After confirming the above behavior, open the manual cock. Turn on the reset switch, restart the burner and check if it ignites normally.

(4) Power loss (power failure) check

Turn off the power switch during burner operation in order to stop combustion. After waiting for a while, turn on the power switch again.

Then, turn on the start input, restart the burner and check if it ignites normally.

Chapter 6. Maintenance and Inspection

WARNING



Ensure you turn off the power of this device and all auxiliary devices when mounting, removing or connecting the wires of this device. There is a risk of electrical shock.



Terminal 14 (F) retains an electrical charge even after the power is turned off. Do not touch terminal 14 (F) even after turning the power off. Doing so may result in an electric shock.

CAUTION



Mounting, wiring, maintenance, inspection, calibration, etc. should be carried out by a professional with technical training in combustion systems and combustion safety devices.



If the device undergoes safety shutoff and restarts, do all of the inspection steps described in chapter 5, "Trial Operation and Adjustment."



As part of the maintenance and inspection of the burner, make sure to do the pilot turn-down test. Inspect the burner at least once a year.



Also, follow the instructions for periodic inspection that are given in the combustion equipment manufacturer's manual.



When cleaning the burner, clean the flame detector also.

■ General maintenance and inspection

- When replacing this device, do all of the checks and adjustments, including those mentioned in the notices on page 1.
- Do not lubricate any part of this device.
- Remove any products of combustion that are stuck to the burner or other equipment.

■ Maintenance and inspection cycle

The maintenance and inspection cycle should take into consideration the device type, ambient conditions of the installation location, the frequency of use, etc. The following are approximate guidelines.

- Cleaning the burner: once or more per year
After cleaning, make sure to do the pilot turn-down test.
- Burner shutdown check: once or more per month
- Flame voltage check: once or more per month

■ Alarm codes and details

When a lock-out occurs, an alarm code is displayed automatically. When an alarm occurs, the sequence number and alarm code issued when the lock-out occurred are displayed alternately. Refer to chapter 4, "Relationship between Error Occurrence and Sequence."

Alarm codes	Sub-code	Description	Status
E0	None	Interlock operation	Lock-out interlock
E1		False flame	A flame signal was detected for five seconds during the period from startup to pre-purge.
E2		Air-flow switch error [1]	The air-flow switch turned off during combustion.
E3		Air-flow switch error [2]	The air-flow switch stayed on for 3 minutes during the start check.
		Air-flow switch error [2]	The air-flow switch stayed off for 3 minutes during pre-purge.
E4		High fire interlock error	High fire interlock input stayed OFF for three minutes during pre-purge Note: Stops the counting of purge time during the purge. Resumes the purge from the point when the high-fire interlock is turned ON / low-fire interlock is turned OFF.
E5		Low fire interlock error [1] [2]	(1) The low fire interlock turned off between pilot ignition and main stabilization (2) The low fire interlock remained Off for three minutes during ignition standby Note: Stops the counting of the ignition wait time while low-fire interlock is OFF. Resumes the purge from the point when the high-fire interlock is turned OFF / low-fire interlock is turned ON.
E6		Ignition failure	Ignition could not be detected during the ignition trial
E7	Flame failure	The flame signal disappeared during the sequence after the ignition trial	
E8		POC (proof of closure) error	POC (proof of closure) switch was detected to be off (open) when the main valve was closed. POC (proof of closure) switch was detected to be on (closed) when the main valve was open. Note: To disable POC with the POC selection settings, refer to "Function setting mode" in chapter 3, "Operation."
E9	01	High/low interlock input discrepancy	High fire and low fire interlock input both stayed ON for three minutes Note: Stops the counting of purge time during the purge. Resumes the purge from the point when the high-fire interlock is turned ON / low-fire interlock is turned OFF. Note: During the ignition standby, this error stops the counting of ignition wait time. Ignition standby resumes from the point when the high-fire interlock is turned OFF / low-fire interlock is turned ON. Note: The sequence moves from P4 (pilot or main burner ignition) to P8 (normal combustion) in that order.
E9	02	Switch input error	The DISP switch, RESET switch or reset input stayed on for 60 seconds. Note: Monitoring continues without interruption while the power is ON.
E9	03	Internal relay feedback (K1)	Failure in the internal K1 relay drive system Note: If the problem persists even after reset, there is a chance that the BC-R35 is out of order.
E9	04	Terminal 4 and 5 voltage discrepancy (K2)	Failure, ground fault, or incorrect wiring in the internal K2 relay drive system Note: Make sure that all combustion-related common load outputs connected to terminals 6, 7 and 8 are wired to terminals 4 and 5.
E9	05	Terminal 7 voltage discrepancy (PV)	Failure, ground fault, or incorrect wiring in the relay, together with detection of a voltage error in the pilot valve output Note: This error can occur if voltage is applied to terminal 7 by a ground fault or external circuit (such as a bypass circuit), or if something is wrong with relay K3 (such as contact welding).
E9	06	Terminal 8 voltage discrepancy (MV)	Failure, ground fault, or incorrect wiring of the relay, together with detection of a voltage error in the main valve output Note: This error can occur if voltage is applied to terminal 8 by a ground fault or external circuit (such as a bypass circuit), or if something is wrong with relay K4 (such as contact welding).
E9	07	Terminal 6 voltage discrepancy (IG)	Voltage was detected for 30 seconds while the terminal 6 ignition transformer output was OFF. Note: This error can occur if voltage is applied to terminal 6 by a ground fault or external circuit (such as a bypass circuit), or if something is wrong with relay K5 (such as contact welding).
E9	08	Alarm activation at power ON	When the cause of lock-out cannot be identified - Power was turned off before CPU error judgment after lock-out occurred - Latch relay was set to lock-out due to vibration during transport or for other reasons
E9	50 to 71	Other failures	Malfunction due to failure of BC-R35 or external electrical noise. * Check if there is a problem with the ignition transformer grounding or if a high-voltage cable is running alongside a signal wire. If there is an inverter or other device that generates strong electrical noise, take measures based on the user's manual for that device. Note: If the problem persists even after reset, there is a chance that the BC-R35 is out of order.

- If the sequence step cannot be identified when lockout occurs, the displayed sequence code may be "--" (stopped).

■ Failure inspection flow

⚠ WARNING



Before removing, mounting, or wiring the module, be sure to turn OFF the power to the module and all connected devices. Failure to do so may result in an electric shock.

If there is any problem with the device, follow the inspection procedure below.

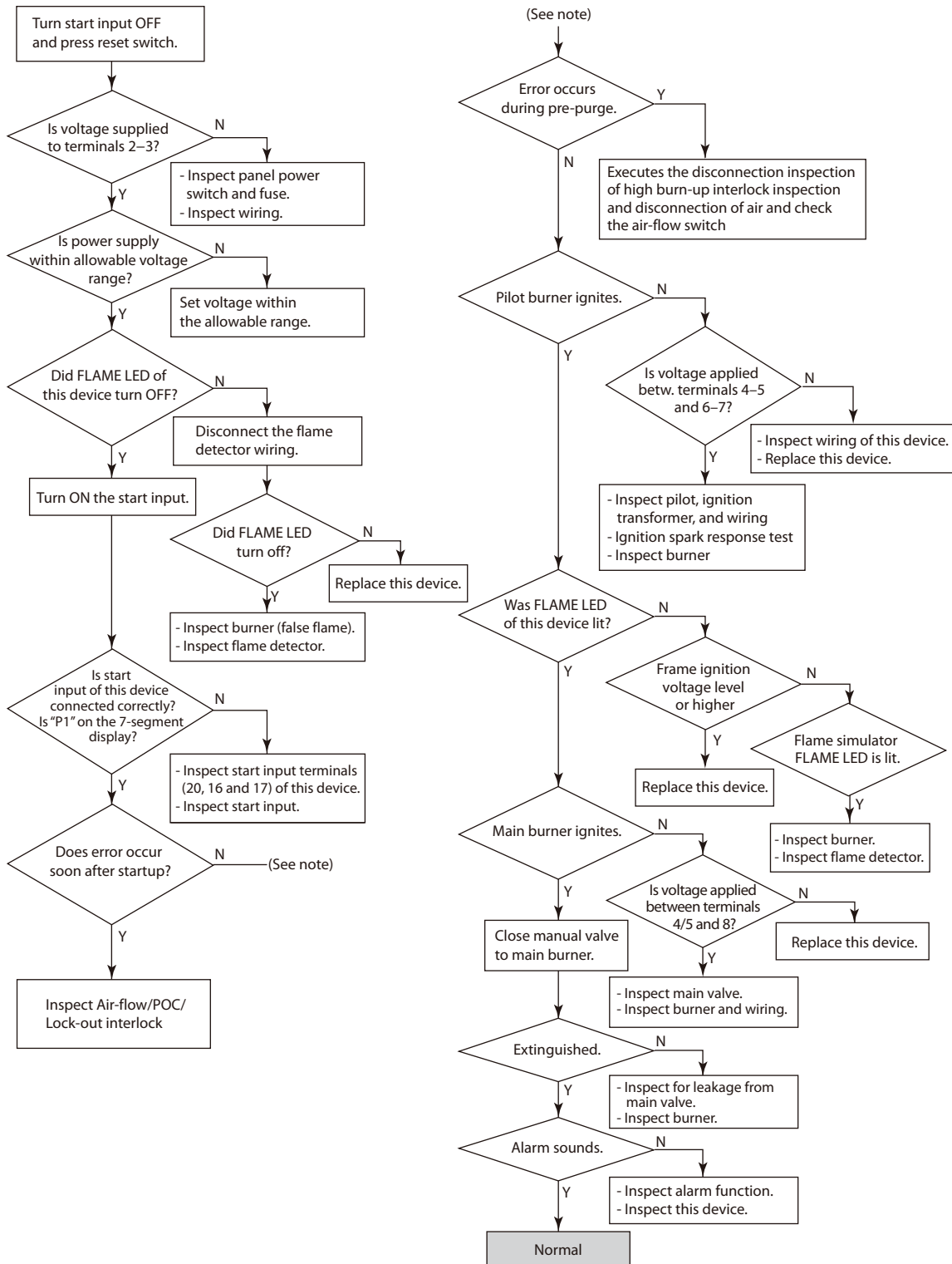

Chapter 7. Specifications

Item		Description								
Application		Batch-operated combustion systems burning gas, oil, or gas/oil mixture								
Compatible flame detector		AUD100/110/120 series UV sensor, flame rod, AFD100/110 series visible light flame detector, contact input								
Sequence	Sequence timing	Pre-purge	Ignition trial *1	Pilot stabilization (Hi-valve ignition standby) *1	Main trial (Hi-valve ignition) *1	Ignition standby	Main trial	Low fire stop (max.)	Post-purge	
		35 s, 3 min (select by model number) *2	4.5±0.5 s	8.5±1 s	4.5±0.5 s	7.5±1 s	8.5±1 s	Approx. 45 s	20±2 s	
	Flame failure response timing	AUD100/100/120 series UV sensor		Flame rod (ionization)		AFD100/110 series visible light flame detector		Contact input		
		2 s max (nominally 1.5 s) (when flame voltage is 3 V)		2 s max (nominal 1.5 s) (when flame voltage is 2 V)		2 s max. (20 lx -> 0 lx)		1 s max.		
	Reset timing		1 s or longer (reset switch or contact reset input)							
	Alarm detection timing	False flame	Air-flow Switch Error (1)	Air-flow Switch Error (2)	Interlock Error	Low fire Interlock error (1)	Low fire Interlock error(2)	High fire Interlock Error	POC (proof of closure) error	
		5 s	1 s max.	180 s	1 s max.	1 s max.	180 s	180 s	3 s	
	Air-flow switch observation		Available (performs observation of air-flow switch malfunction (1), (2))							
	Operation at ignition failure		Lock-out							
	Operation at flame failure		Lock-out							
Low fire stop *2		During shutdown, checks low fire position, then transitions to post-purge								
Electrical specifications	Rated power supply		100 Vac or 200 Vac at 50 Hz/60Hz (flame rod / UV sensor) 100-230 Vac at 50 Hz/60Hz (visible light sensor / contact)							
	Allowable power supply voltage		85-110% of rated power supply							
	Power consumption		10 W or less							
	Dielectric strength		1500 Vac for 1 min, or 1800 Vac for 1 s Between each terminal and ground (the DIN rail clamp), except for combustion sensor connection terminals (terminals 14, 15)							
	Insulation resistance		50 MΩ min. with 500 Vdc megger Between each terminal and ground (the DIN rail clamp), except for combustion sensor connection terminals (terminals 14, 15)							
	Contact rating		Blower motor (electromagnetic switch)	Ignition transformer	Pilot valve (main valve Lo solenoid valve) *1	Main valve (main valve Hi solenoid valve) *1	Alarm	Control motor open output, Closed output, proportional output		
		100 VA	300 VA	200 VA	200 VA	75 VA	200 VA			
Monitor outputs *3		4, maximum 30 mA each								
Flame detection level	UV sensor AUD100/100/120 series		Flame rod (ionization)		Visible light flame detector AFD100/110 series		Contact input			
	Flame establishment: 1.5-4.5 Vdc Flame-out detection: 0.2-0.6 Vdc		Flame establishment: 1.5-4.5 Vdc Flame-out detection: 0.0-0.2 Vdc		Flame establishment: 1.3 V or less Flame-out detection: 0.5 V or above		When ignition is detected: Short circuit between terminals F-G When flame is not detected: Open between terminals F-G			
Flame voltage output		Recommended flame voltage: Must be stable at 2 Vdc or above Flame voltage output range: 0.2-4.5 Vdc	Recommended flame voltage: Must be stable at 2 Vdc or above Flame voltage output range: 0.0-4.5 Vdc	Flame voltage output range: 0.2-4.8 Vdc		Flame establishment: 4.0 Vdc or more Flame-out detection: 0.5 Vdc or less				
Input		Start, lock-out interlock, contact reset, air-flow switch, POC (shutoff valve proof of closure), low fire interlock, high fire interlock * Each input is a non-voltage contact input, with allowable contact resistance up to 500 Ω								
Life		10 years when used for eight hours per day, or 100,000 start/stop cycles (at 25 °C, room humidity, rated voltage)								

Chapter 7. Specifications

Operating conditions	Ambient temperature	-20 to +60°C
	Ambient humidity	10-90% RH (no condensation)
	Vibration	0-3.2 m/s ² (10-150 Hz, 1 octave/minute, 10 cycles, in each of XYZ directions)
	Shock	0-9.8 m/s ²
	Mounting angle	Reference plane +/-10°
	Dust	0.3 mg/m ³ or less
General Specifications	Protection rating	IP40 (with sideboards (81447515-001) attached to the sub-base (BC-R05)) IP10 (sub-base (BC-R05) only)
	Overvoltage category	II
	Pollution degree	PD2
	Case color	Black
	Case material	Denatured PPE resin (UL94-V0 PTI Material group IIIa)
	Structure	Sub-base and main device
	Mounted orientation	Vertical or horizontal However, for horizontal attachment, 7 segment display can only be mounted so that it faces directly overhead. (DIN rail mounting or direct mounting through base screw holes)
	Standards	JIS C 9730-2-5:2010 (Automatic Electrical Controls For Household And Similar Use - Part 2-5: Particular Requirements For Automatic Electrical Burner Control Systems) Compliant with JIS C 9730-1:2010 (Automatic Electrical Controls For Household And Similar Use - Part 1: General Requirements)
	Dimensions	W95 × H105 × D110 mm
Weight	Approximately 600 g (incl. sub-base)	
Wiring types and max. wiring length	<ul style="list-style-type: none"> • Start, air-flow switch, lockout interlock, POC (proof of closure), low fire interlock, High fire interlock Copper IV wire with 600 V vinyl insulation, 1.25 mm² Recommended condition: 20 m or less, maximum wiring length: 100 m • Contact reset Copper IV wire with 600 V vinyl insulation, 1.25 mm², maximum wiring length: 10 m • AUD100 Series (F, G) Copper IV wire with 600 V vinyl insulation, 1.25 mm², maximum wiring length: 100 m • Flame rod (F, G) RG-11U (JAN standard: US DoD compliant specification) Or equivalent 5C2V, 7C2V (JIS standard) Recommended condition: 20 m or less, maximum wiring length: 30 m • AFD sensor (F, G) Copper IV wire with 600 V vinyl insulation, 1.25 mm² Maximum wiring length: 10 m • Contact input (F, G) Copper IV wire with 600 V vinyl insulation, 1.25 mm² Maximum wiring length: 10 m • RS-485 communications (3-wire system) 0.2-1.5 mm² Shielded twisted pair cable (recommended) Maximum wiring length: 500 m • Flame voltage output signal circuit IV wire 0.75 mm² or larger, max. wiring length 10 m 	

*1 Item in () is for the case of direct ignition.

*2 Visible light flame detector and contact input model do not have the low fire stop function.

*3 If an inductive load is used, connect a protection circuit such as an RC snubber to the load in parallel.

External dimensions

Unit: mm

● Body

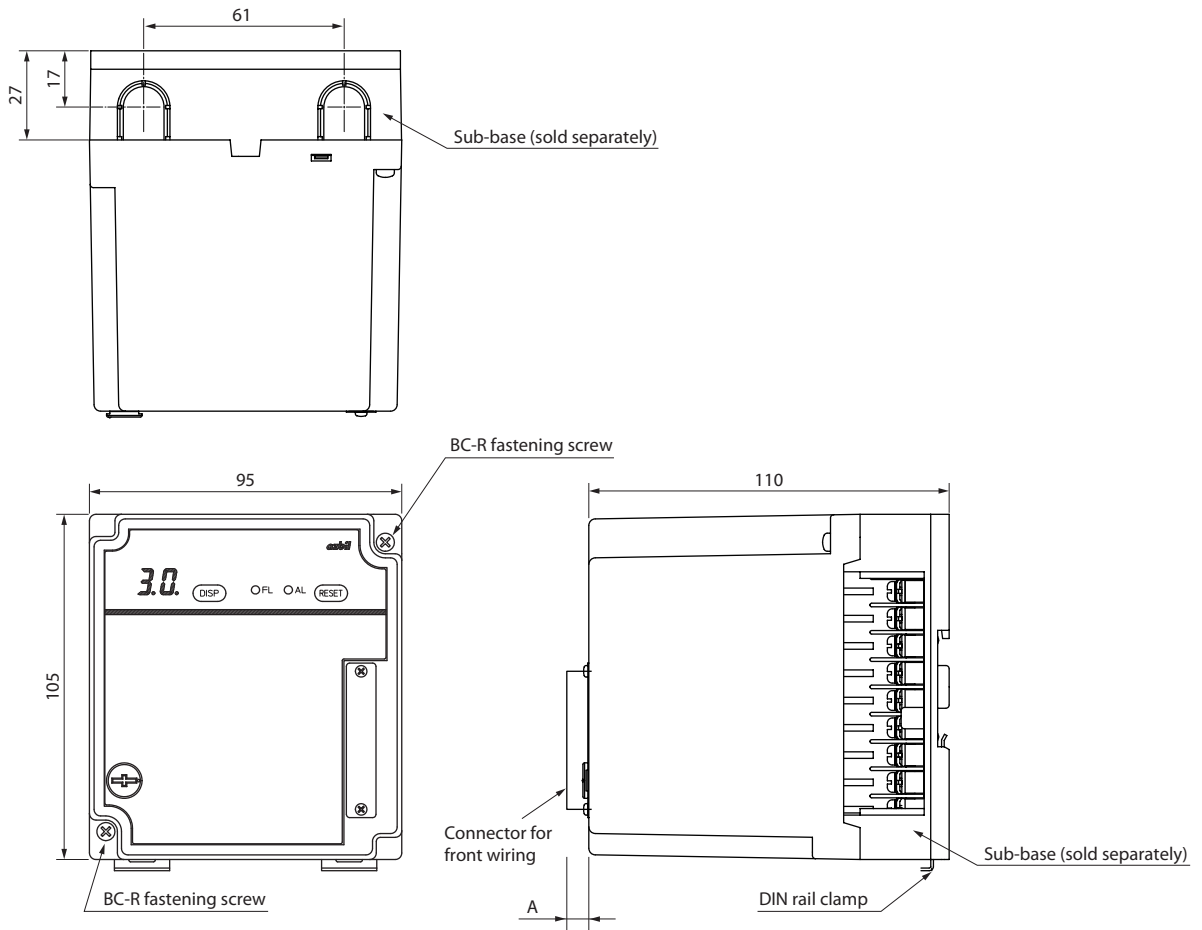

Model number	A
81447514-001	10.6
81447514-002	14.6

● Sub-base BC-R05A100 (sold separately)

Unit: mm

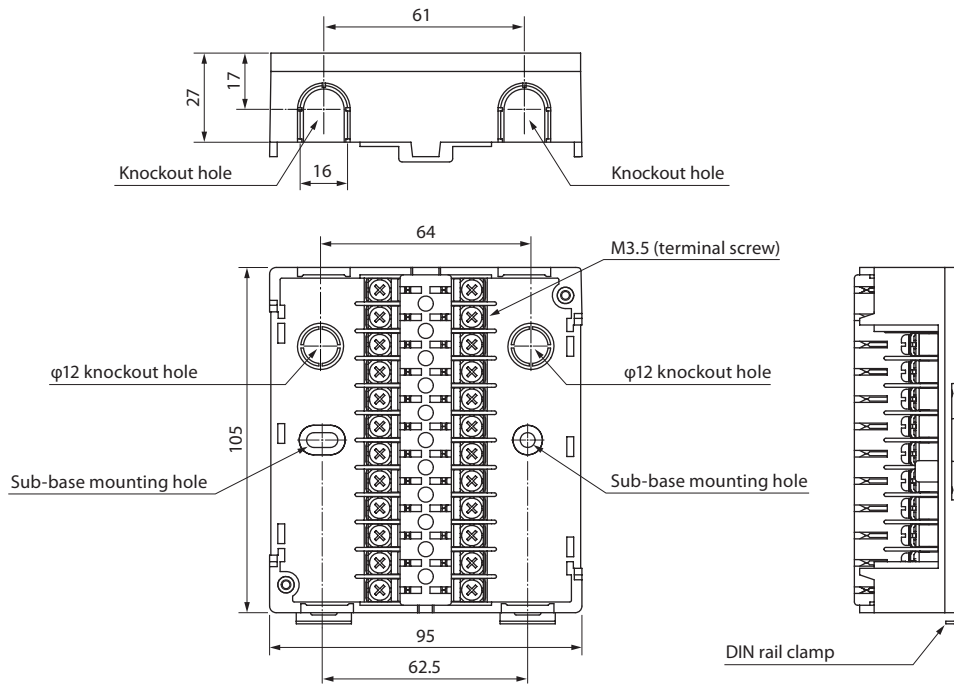

● Sideboard 81447515-001 (sold separately)

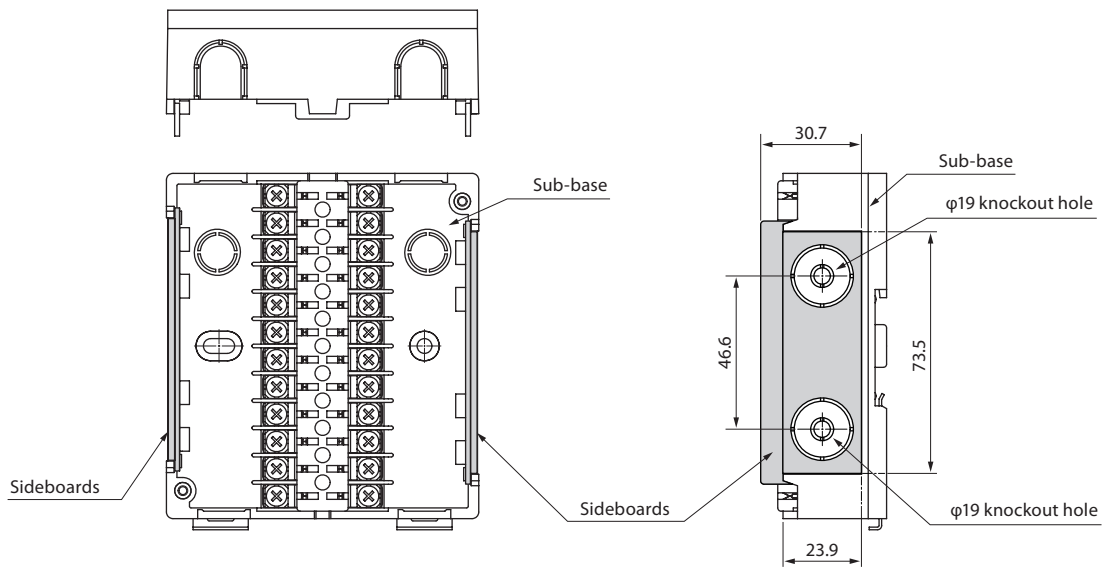

Revision History of CP-SP1389E

Printed	Edn.	Revised pages	Description
Feb. 2015	1		
Jun. 2015	2	ii, iii 6, 7 63 64	Warnings and cautions were partly revised in the Safety Precautions section. Warnings and cautions were partly revised in Chapter 2. "*3" was added to the end of "Monitor outputs." A note was added as *3.

Terms and Conditions

We would like to express our appreciation for your purchase and use of Azbil Corporation's products. You are required to acknowledge and agree upon the following terms and conditions for your purchase of Azbil Corporation's products (system products, field instruments, control valves, and control products), unless otherwise stated in any separate document, including, without limitation, estimation sheets, written agreements, catalogs, specifications and instruction manuals.

1. Warranty period and warranty scope

1.1 Warranty period

Azbil Corporation's products shall be warranted for one (1) year from the date of your purchase of the said products or the delivery of the said products to a place designated by you.

1.2 Warranty scope

In the event that Azbil Corporation's product has any failure attributable to azbil during the aforementioned warranty period, Azbil Corporation shall, without charge, deliver a replacement for the said product to the place where you purchased, or repair the said product and deliver it to the aforementioned place.

Notwithstanding the foregoing, any failure falling under one of the following shall not be covered under this warranty:

- (1) Failure caused by your improper use of azbil product (noncompliance with conditions, environment of use, precautions, etc. set forth in catalogs, specifications, instruction manuals, etc.);
- (2) Failure caused for other reasons than Azbil Corporation's product;
- (3) Failure caused by any modification or repair made by any person other than Azbil Corporation or Azbil Corporation's subcontractors;
- (4) Failure caused by your use of Azbil Corporation's product in a manner not conforming to the intended usage of that product;
- (5) Failure that the state-of-the-art at the time of Azbil Corporation's shipment did not allow Azbil Corporation to predict; or
- (6) Failure that arose from any reason not attributable to Azbil Corporation, including, without limitation, acts of God, disasters, and actions taken by a third party.

Please note that the term "warranty" as used herein refers to equipment-only-warranty, and Azbil Corporation shall not be liable for any damages, including direct, indirect, special, incidental or consequential damages in connection with or arising out of Azbil Corporation's products.

2. Ascertainment of suitability

You are required to ascertain the suitability of Azbil Corporation's product in case of your use of the same with your machinery, equipment, etc. (hereinafter referred to as "Equipment") on your own responsibility, taking the following matters into consideration:

- (1) Regulations and standards or laws that your Equipment is to comply with.
- (2) Examples of application described in any documents provided by Azbil Corporation are for your reference purpose only, and you are required to check the functions and safety of your Equipment prior to your use.
- (3) Measures to be taken to secure the required level of the reliability and safety of your Equipment in your use
Although azbil is constantly making efforts to improve the quality and reliability of Azbil Corporation's products, there exists a possibility that parts and machinery may break down.
You are required to provide your Equipment with safety design such as fool-proof design, *1 and fail-safe design*2 (anti-flame propagation design, etc.), whereby preventing any occurrence of physical injuries, fires, significant damage, and so forth. Furthermore, fault avoidance, *3 fault tolerance,*4 or the like should be incorporated so that the said Equipment can satisfy the level of reliability and safety required for your use.

*1. A design that is safe even if the user makes an error.

*2. A design that is safe even if the device fails.

*3. Avoidance of device failure by using highly reliable components, etc.

*4. The use of redundancy.

3. Precautions and restrictions on application

Azbil Corporation's products other than those explicitly specified as applicable (e.g. azbil Limit Switch For Nuclear Energy) shall not be used in a nuclear energy controlled area (radiation controlled area).

Any Azbil Corporation's products shall not be used for/with medical equipment.

The products are for industrial use. Do not allow general consumers to install or use any Azbil Corporation's product.

However, azbil products can be incorporated into products used by general consumers. If you intend to use a product for that purpose, please contact one of our sales representatives.

In addition,

you are required to conduct a consultation with our sales representative and understand detail specifications, cautions for operation, and so forth by reference to catalogs, specifications, instruction manual, etc. in case that you intend to use azbil product for any purposes specified in (1) through (6) below.

Moreover, you are required to provide your Equipment with fool-proof design, fail-safe design, anti-flame propagation design, fault avoidance, fault tolerance, and other kinds of protection/safety circuit design on your own responsibility to ensure reliability and safety, whereby preventing problems caused by failure or nonconformity.

- (1) For use under such conditions or in such environments as not stated in technical documents, including catalogs, specification, and instruction manuals
- (2) For use of specific purposes, such as:
 - * Nuclear energy/radiation related facilities
[For use outside nuclear energy controlled areas] [For use of Azbil Corporation's Limit Switch For Nuclear Energy]
 - * Machinery or equipment for space/sea bottom
 - * Transportation equipment
[Railway, aircraft, vessels, vehicle equipment, etc.]
 - * Antidisaster/crime-prevention equipment

- * Burning appliances
 - * Electrothermal equipment
 - * Amusement facilities
 - * Facilities/applications associated directly with billing
- (3) Supply systems such as electricity/gas/water supply systems, large-scale communication systems, and traffic/air traffic control systems requiring high reliability
 - (4) Facilities that are to comply with regulations of governmental/public agencies or specific industries
 - (5) Machinery or equipment that may affect human lives, human bodies or properties
 - (6) Other machinery or equipment equivalent to those set forth in items (1) to (5) above which require high reliability and safety
4. Precautions against long-term use

Use of Azbil Corporation's products, including switches, which contain electronic components, over a prolonged period may degrade insulation or increase contact-resistance and may result in heat generation or any other similar problem causing such product or switch to develop safety hazards such as smoking, ignition, and electrification. Although acceleration of the above situation varies depending on the conditions or environment of use of the products, you are required not to use any Azbil Corporation's products for a period exceeding ten (10) years unless otherwise stated in specifications or instruction manuals.
 5. Recommendation for renewal

Mechanical components, such as relays and switches, used for Azbil Corporation's products will reach the end of their life due to wear by repetitious open/close operations. In addition, electronic components such as electrolytic capacitors will reach the end of their life due to aged deterioration based on the conditions or environment in which such electronic components are used. Although acceleration of the above situation varies depending on the conditions or environment of use, the number of open/close operations of relays, etc. as prescribed in specifications or instruction manuals, or depending on the design margin of your machine or equipment, you are required to renew any Azbil Corporation's products every 5 to 10 years unless otherwise specified in specifications or instruction manuals. System products, field instruments (sensors such as pressure/flow/level sensors, regulating valves, etc.) will reach the end of their life due to aged deterioration of parts. For those parts that will reach the end of their life due to aged deterioration, recommended replacement cycles are prescribed. You are required to replace parts based on such recommended replacement cycles.
 6. Other precautions

Prior to your use of Azbil Corporation's products, you are required to understand and comply with specifications (e.g., conditions and environment of use), precautions, warnings/cautions/notices as set forth in the technical documents prepared for individual Azbil Corporation's products, such as catalogs, specifications, and instruction manuals to ensure the quality, reliability, and safety of those products.
 7. Changes to specifications

Please note that the descriptions contained in any documents provided by azbil are subject to change without notice for improvement or for any other reason. For inquires or information on specifications as you may need to check, please contact our branch offices or sales offices, or your local sales agents.
 8. Discontinuance of the supply of products/parts

Please note that the production of any Azbil Corporation's product may be discontinued without notice. For repairable products, we will, in principle, undertake repairs for five (5) years after the discontinuance of those products. In some cases, however, we cannot undertake such repairs for reasons, such as the absence of repair parts. For system products, field instruments, we may not be able to undertake parts replacement for similar reasons.
 9. Scope of services

Prices of Azbil Corporation's products do not include any charges for services such as engineer dispatch service. Accordingly, a separate fee will be charged in any of the following cases:

 - (1) Installation, adjustment, guidance, and attendance at a test run
 - (2) Maintenance, inspection, adjustment, and repair
 - (3) Technical guidance and technical education
 - (4) Special test or special inspection of a product under the conditions specified by you

Please note that we cannot provide any services as set forth above in a nuclear energy controlled area (radiation controlled area) or at a place where the level of exposure to radiation is equivalent to that in a nuclear energy controlled area.

azbil

Specifications are subject to change without notice. (09)

Azbil Corporation
Advanced Automation Company

1-12-2 Kawana, Fujisawa
Kanagawa 251-8522 Japan

URL: <http://www.azbil.com>

1st edition: Feb. 2015 (K)
2nd edition: Jun. 2015 (V)