

# rotork®

Keeping the World Flowing

## IQ Range



Instructions for Safe Use, Installation,  
Basic Setup and Maintenance

**⚠ This manual contains important safety information. Please ensure it is thoroughly read and understood before installing, operating or maintaining the equipment.**

PUB002-039-00  
Date of issue 07/19



CE

## Table of Contents

---

<b>1. Introduction</b> .....	<b>3</b>	<b>6. Mounting the Actuator</b> .....	<b>14</b>	<b>9. Maintenance, Monitoring and Troubleshooting</b> .....	<b>28</b>
1.1 Identifying Actuator Parts .....	3	6.1 Rising Stem Valves Top Mounted .....	15		
1.2 Rotork Setting Tool .....	4	6.2 Valve with Gearbox – Side Mounting .....	15	<b>10. Decommissioning and Environmental Considerations</b> .....	<b>30</b>
1.3 Introduction to this manual .....	5	6.3 Non-Rising Stem Valves – Top Mounting .....	15		
<b>2. Health and Safety</b> .....	<b>5</b>	6.4 Handwheel Sealing .....	16	<b>11. Weights and Measures</b> .....	<b>31</b>
2.1 ATEX/IEC EX Certified Actuators .....	7	6.5 IQM Modulating Actuators .....	16		
<b>3. Storage</b> .....	<b>7</b>	6.6 IQL & IQML Linear Drive Unit .....	16	<b>12. IQ Approvals</b> .....	<b>32</b>
<b>4. Operating your IQ Actuator</b> .....	<b>8</b>	6.7 IQL & IQML Adjusting Linear Stroke .....	17		
4.1 Operating by Hand .....	8	<b>7. Cable Connections</b> .....	<b>17</b>	<b>13. Approved Fuses</b> .....	<b>34</b>
4.2 Operating Electrically .....	8	7.1 Terminal Block Layout .....	17		
4.3 Display - Local Indication .....	9	7.2 Earth/Ground Connections .....	18	<b>14. Vibration, Shock and Noise</b> .....	<b>34</b>
4.4 Display – Home screen selection .....	10	7.3 Removing Terminal Cover .....	18		
4.5 Display Status Indication – Travel .....	11	7.4 Cable Entry .....	20	<b>15. Conditions of Safe Use</b> .....	<b>34</b>
4.6 Display Status Indication – Control .....	11	7.5 Connecting to Terminals .....	20	15.1 Thread details for ATEX and IECEx Approved actuators .....	34
4.7 Display Alarm Indication .....	11	7.6 Replacing Terminal Cover .....	21	15.2 Maximum constructional flame path gaps for ATEX and IECEx Approved actuators .....	35
4.8 Battery Alarm .....	11	<b>8. Commissioning - Basic Settings</b> .....	<b>21</b>		
<b>5. Preparing the Drive Bush</b> .....	<b>12</b>	8.1 Connecting to the Actuator .....	22		
5.1 IQ base all sizes types A and Z3 .....	12	8.2 Security - Password .....	23		
5.2 Non-Thrust Base Type B .....	13	8.3 Basic Settings Menu .....	24		
		8.4 Basic Settings – Limits .....	25		
		8.5 Close Settings .....	26		
		8.6 Open Settings .....	26		
		8.7 Torque Switch Bypass .....	27		

# 1. Introduction

## 1.1 Identifying Actuator Parts

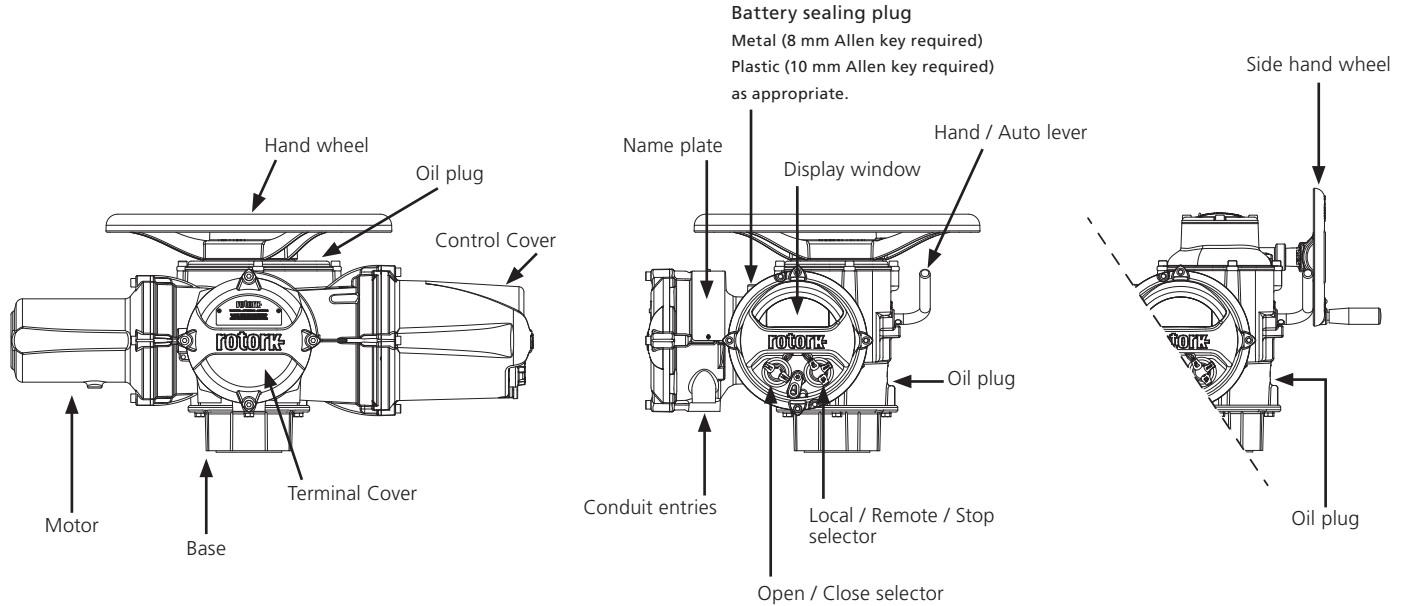

## 1.2 Rotork Setting Tool

The Rotork Bluetooth® Setting Tool Pro (BTST) combines the legacy IR and IrDA communication protocols with the latest *Bluetooth*® wireless technology. IR / IrDA support for older Rotork products is retained (for use as an IR communication tool, please refer to publications PUB002-003 and PUB002-004).

The new BTST is able to connect to Rotork Bluetooth wireless enabled actuators and related software to setup and complete missions. Missions are configurable programs of instructions that are to be performed by the BTST on an actuator and include (but are not limited to) downloading configuration and datalogger files as well as uploading specific configurations to the actuator. Different missions can be programmed into the BTST via Insight2.



Rotork Bluetooth® Setting Tool Pro

### Specification

Enclosure:

Constructed in accordance with IEC 60529 to IP54.

The BTST has been built in accordance with the following standards:

ATEX II 1 G, Ex ia IIC T4 Ga

IECEX – Ex ia IIC T4 Ga

USA – FM Int Safe Class I, Div 1, Groups A, B, C & D, T4

Canada – CSA Exia Int Safe, Class I, Div 1, Groups A, B, C & D, T4

Ambient Temperature Range:

Tamb = -30 °C to +50 °C

Operating Range:

Infra Red 0.75m

Bluetooth 10m

Enclosure Materials:

Polycarbonate ABS blend, Polycarbonate and Silicon Rubber

### Instructions for Safe Selection, Installation, Use, Maintenance & Repair

**1.** The BTST must only be used in hazardous areas (potentially explosive atmosphere) permitted by the equipment classification, temperature class and ambient temperature range stated above (this is also stated on the back of the BTST).

**2.** The following checks must be conducted on the BTST prior to taking it into a hazardous area:

**a.** The BTST function must be checked by ensuring that the red or green LED, either in the clear window or under the 'Enter' key of the BTST, illuminates when any button is pressed. If an LED does not illuminate, there is a potential functional problem with the BTST and the inspection or battery replacement stated below in paragraph 6 must be performed.

**b.** If the BTST is likely to come in contact with aggressive substances (e.g. solvents that may affect polymeric materials), then it is the responsibility of the user to take suitable precautions (e.g. regular checks as part of the routine inspections or establishing that the enclosure materials are resistant to the specific chemicals) that prevent the BTST being adversely affected, thus ensuring that the type of protection is not compromised.

**3.** It is essential that the actuator settings are checked for compatibility with the valve, process and control system requirements before the actuator is put into service.

**4.** No user adjustment of the BTST is required.

**5.** The BTST must be inspected every three months, in a safe (non-hazardous), dry area by suitably trained personnel, to ensure it has been maintained in accordance with the applicable code of practice.

**6.** In accordance with the BTST hazardous area approvals and with the recommendations from the approved battery suppliers, the following are mandatory requirements for safe use:

**a.** The inspections or replacement of the batteries must be conducted in a safe (non-hazardous), dry area.

**b.** The batteries must be removed from the BTST when it is not expected to be used for 3 months or longer.

**c.** Discharged batteries must be removed from the BTST to prevent possible damage.

**d.** The battery compartment of the BTST must be inspected every 3 months for any battery leakage. If any battery leakage has occurred then the BTST must not be used.

e. Only the following approved Alkaline-Manganese or Zinc-Manganese type 'AAA' size batteries must be fitted to the BTST:

- Duracell: Procell MN2400
- Energizer: E92

f. Always replace all four batteries at the same time. Always use four unused batteries of the same approved manufacturer, type and expiry date code.

g. Ensure the batteries are fitted with the correct polarity. The battery polarity (+) is indicated on the inside of the battery compartment of the BTST.

7. The BTST contains no other user replaceable parts and it cannot be repaired by the user. If the BTST is faulty or needs repairing, it must not be used.

### 1.3 Introduction to this manual

This manual provides instruction on:

- Manual and electrical (local and remote) operation.
- Preparation and installation of the actuator onto the valve.
- Basic commissioning.
- Maintenance.

**Refer to Publication PUB002-047 for repair, overhaul and spare part instructions.**

**Refer to Publication PUB002-040 for secondary function configuration instructions.**

Using the supplied Rotork Bluetooth® Setting Tool *Pro* to access the actuator set up procedures, non-intrusive setting of torque levels, position limits and all other control and indication functions can be made safely, quickly and conveniently, even in hazardous locations. The IQ allows commissioning and adjustment to be carried out with the main power supply to the actuator switched on or off.

**The setting tool is packed in the shipping box identified with a yellow label.**

Visit our web site at [www.rotork.com](http://www.rotork.com) for more information on the IQ, Insight2 and other Rotork actuator ranges.

## 2. Health and Safety

This manual is produced to enable a competent user to install, operate, adjust and inspect Rotork IQ range valve actuators. Only persons competent by virtue of their training or experience should install, maintain and repair Rotork actuators.

Under no circumstances should replacement parts be used in Rotork actuators, other than those supplied or specified by Rotork.

Work undertaken must be carried out in accordance with the instructions in this and any other relevant manuals.

If the actuator is used in a manner not specified in this manual and any other Rotork manual, the protection provided by the actuator may be impaired.

The user and those persons working on this equipment should be familiar with their responsibilities under any statutory provisions relating to the Health and Safety of their workplace. Due consideration of additional hazards should be taken when using the IQ range of actuators with other equipment. Should further information and guidance relating to the safe use of the Rotork IQ range of actuators be required, it will be provided on request. The electrical installation, maintenance

and use of these actuators should be carried out in accordance with the National Legislation and Statutory Provisions relating to the safe use of this equipment, applicable to the site of installation.

For the UK: Electricity at Work 'Regulations 1989 and the guidance given in the applicable edition of the "IEE Wiring Regulations" should be applied. Also the user should be fully aware of his duties under the Health and Safety Act 1974. For the USA: NFPA70, National Electrical Code® is applicable.

The mechanical installation should be carried out as outlined in this manual and also in accordance with relevant standards such as British Standard Codes of Practice. If the actuator has nameplates indicating that it is suitable for installation in hazardous areas then the actuator may be installed in Zone 1, Zone 21, Zone 2 and Zone 22 (or Div 1 or Div 2, class I or Class II) classified hazardous area locations only. It should not be installed in hazardous area locations with an ignition temperature less than 135 °C, unless suitability for lower ignition temperatures has been indicated on the actuator nameplate.

It should only be installed in hazardous area locations compatible with the gas and dust groups stated on the nameplate.

The electrical installation, maintenance and the use of the actuator should be carried out in accordance with the code of practice relevant for that particular Hazardous Area certification.

No inspection or repair should be undertaken unless it conforms to the specific hazardous area certification requirements. Under no circumstances should any modification or alteration be carried out on the actuator as this could invalidate the actuators hazardous area approval certification. Access to live electrical conductors is forbidden in the hazardous area unless this is done under a special permit to work, otherwise all power should be isolated and the actuator moved to a non-hazardous area for repair or attention.

**⚠ WARNING: Service Altitude**

Actuator installation is permitted up to 5000 m with the following restrictions:

- Actuator power supply is not above 480 V
- Input and output connections must use the 24 VDC nominal supply
- Mains system must be TT, IT, TN-C-S and 3-phase / wire systems

Installation without restrictions must be less than 2000 m as defined by IEC61010-1 (Safety requirements for electrical equipment for measurement, control and laboratory use).

**⚠ WARNING: Motor Temperature**

Under normal operation the temperature of actuator's motor cover surfaces can exceed 60 °C above ambient.

**⚠ WARNING: Surface Temperature**

The installer/user must ensure that the actuator surface temperature rating is not influenced by external heating/cooling effect (e.g. valve/pipeline process temperatures).

**⚠ WARNING: Thermostat Bypass**

If the actuator is configured to bypass the motor thermostat then the hazardous area certification will be invalidated. Additional electrical hazards may occur when using this configuration. The user should ensure that any necessary additional safety measures are considered.

**⚠ WARNING: Enclosure Materials**

IQ Range of actuators are manufactured from aluminium alloy with stainless steel fasteners and the thrust bases are manufactured in cast iron.

The cover window is toughened glass which is retained with a 2-part silicone cement and the battery plug will be either stainless steel or PPS (Poly-Phenylene Sulfide).

The user must ensure that the operating environment and any materials surrounding the actuator cannot lead to a reduction in the safe use of, or the protection afforded by, the actuator. Where appropriate the user must ensure the actuator is suitably protected against its operating environment.

**⚠ WARNING: Operating by Hand**

With respect to handwheel operation of Rotork electric actuators, refer to section 4.1.

**⚠ WARNING: Actuator may start and operate when remote is selected. This will be dependent on remote control signal status and actuator configuration.**

**⚠ WARNING: Unit Weight**

The actuator weight is shown on the nameplate. Care must be taken to transport, move or lift the actuator safely. Lifting information is available in section 6.

## 2.1 ATEX/IEC EX Certified Actuators

### Special Conditions

This actuator must only be located in areas where the risk of impact to the viewing window is low.

This equipment includes some exterior non-metallic parts including the protective coating. To avoid the possibility of static build up, cleaning must only be carried out with a damp cloth.

### **WARNING: External Enclosure Fasteners**

Enclosure fasteners are stainless steel grade A4 80 except for the following sizes and when marked on the nameplate as shown. In these cases the terminal cover fasteners are carbon steel grade 12.9. If in doubt check the grade marked on the relevant fastener or contact Rotork.

### **Actuator Size: IQ/IQM/IQS 20 & 35 or IQ/IQM 25**

Ex d IIB T4 Gb (-30°C to +70°C)

Ex d IIB T4 Gb (-40°C to +70°C)

Ex d IIB T4 Gb (-50°C to +40°C)

Certificate No: SIRA 12ATEX1123X or IECEx SIR 12.0047X

### **Actuator Size: IQ/IQM 20 & 25 or IQS20**

Model: IQ3FM - Explosionproof, Class I, Div 1, Groups B, C, D

FM Approved

## 3. Storage

If your actuator cannot be installed immediately, store it in a dry place until you are ready to connect incoming cables.

If the actuator has to be installed but cannot be cabled it is recommended that the plastic transit cable entry plugs are replaced with metal plugs which are sealed with PTFE tape.

The Rotork double-sealed construction will preserve internal electrical components perfectly if left undisturbed.

It is not necessary to remove any electrical compartment covers in order to commission the IQ actuator.

Rotork cannot accept responsibility for deterioration caused on-site once the covers are removed.

Every Rotork actuator has been fully tested before leaving the factory to give years of trouble free operation, providing it is correctly commissioned, installed and sealed.

## 4. Operating your IQ Actuator

### 4.1 Operating by Hand

#### **⚠ WARNING**

**With respect to handwheel operation of Rotork electric actuators, under no circumstances should any additional lever device such as a wheel-key or wrench be applied to the handwheel in order to develop more force when closing or opening the valve as this may cause damage to the valve and/or actuator or may cause the valve to become stuck in the seated/ backseated position.**

**Keep clear of the handwheel when engaging hand operation. Actuators driving valves via extension shafts may be subject to retained shaft torsion which can cause the handwheel to rotate when hand operation is engaged.**

**⚠** To engage handwheel drive depress the Hand/Auto lever into "Hand" position and turn the handwheel to engage the clutch. The lever can now be released where it will return to its original position. The handwheel will remain engaged until the actuator is operated electrically when it will automatically disengage and return to motor drive.

If required for local lockout purposes the Hand/Auto lever can be locked in either position using a padlock with a 6.5 mm hasp.

Locking the lever in the "hand" position prevents electrical operation of the actuator moving the valve.

### 4.2 Operating Electrically

Check that power supply voltage agrees with that on the actuator nameplate. Switch on power supply. It is not necessary to check phase rotation.

**⚠ Do not operate the actuator electrically without first checking, using the infra-red Setting Tool, that at least the Basic Settings have been made (refer to Section 8).**

#### **Selecting Local/Stop/Remote Operation**

The red selector enables either Local or Remote control, lockable in each position using a padlock with a 6.5 mm hasp.

When the selector is locked in the Local or Remote positions the Stop facility is still available. The selector can also be locked in the Stop position to prevent electrical operation by Local or Remote control.



Fig. 4.2.1 IQ3 Local Controls

#### **Local Control**

With the red selector positioned at Local (anti-clockwise) the adjacent black knob can be turned to select Open or Close. For Stop, turn red knob clockwise.

#### **Remote Control**

Rotate the red selector to the Remote position (clockwise), this allows remote control signals to operate the actuator. Local Stop can still be used by turning the red knob anti-clockwise.



## 4.3 Display - Local Indication

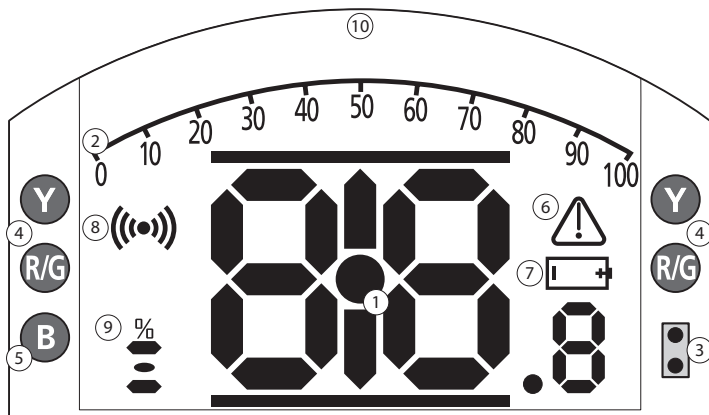

### LED INDICATION: R = RED, G = GREEN, Y = YELLOW, B = BLUE

Fig. 4.3.1 Segment Display

#### 1. Position display

This is the main segment display for position and torque; position indication to 1 decimal place.

#### 2. Analogue Scale

Scale 0% to 100% is used when Analogue torque (% of rated) or Positioning (% position / demand) homescreens are selected. Refer to section 4.4.

#### 3. Infra-red LEDs

Used for older models of setting tool and to initiate a data connection using Bluetooth wireless technology.

#### 4. Dual position LEDs

Consisting of 2 x Yellow for mid position and 2 x bi-colour (Red / Green) for end of travel indication.

#### 5. Bluetooth indication LED

A dual intensity LED for indicating an active connection using Bluetooth wireless technology.

#### 6. Alarm Icon

This will be displayed for valve, control and actuator alarms. Alarm indication is supported by fault description in the text in the line above the main display.

#### 7. Battery Alarm Icon

This icon will be displayed when a battery is detected as low or discharged. "Battery low" or "Discharged" will also be displayed in the text display above.

#### 8. Infra-Red Icon

This icon flashes during setting tool communication activity. LEDs will also flash when keys are pressed.

#### 9. Percentage Open Icon

This icon will be displayed when an integer open value is displayed e.g. 57.3.

#### 10. Dot Matrix Display

A high resolution 168x132 pixel display for displaying setup menus and datalogger graphs.

When a positional display is active, the status and active alarms will be displayed.

The LCD screen is made up of two layers; the main segment display and the dot matrix display. The displays are dual stacked so that either display can be enabled to show different information. This also allows a combination of both displays for added flexibility.

On power the LCD is backlit with a white light to enable the best viewing contrast in all lighting conditions. For additional positional indication, the LEDs at either side of the LCD are used for Closed (green), mid-travel (yellow) and Open (red) as standard. These LEDs are fully configurable in the settings menu or on request at time of order.

#### 4.4 Display – Home screen selection



The actuator display can be set to show any one of the following home screens:

- Position indication
- Position & Digital Torque indication
- Position & Analogue Torque indication
- Position & Control Demand indication

The default home screen is Position. Home screens indicate the live conditions measured by the actuator when mains power is applied. When mains power is switched off the actuator battery powers the display and it will show the position indication display only.

The required home screens can be set by the user either as a permanent display or as a temporary display for valve or actuator operational analysis.

#### Temporary Home Screen display.

Using the setting tool (refer to 8.1)  or  arrow keys, scroll through the available home screens until the required one is displayed. The selected screen will remain displayed for approximately 5 minutes after the last setting tool command or until the actuator power is cycled.

#### Permanent Home Screen display.

Using the setting tool (refer to 8.1) connect to the actuator.

From the **Settings** menu, select **Indication, Local Display**. From the available settings, select **Home Screen**. Enter the password if requested (refer to section 8.2), select Home screen and from the dropdown list, select the required Home screen for permanent display:

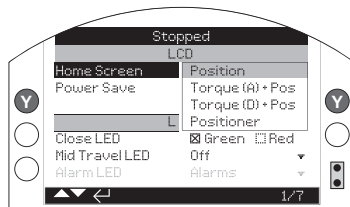

Fig. 4.4.1 Home Screen Selection

**Position** - Default valve position display

**Torque (A) + Pos** - Position with analogue torque indication

**Torque (D) + Pos** - Position with digital torque indication

**Positioner** - Position with digital and analogue position demand indication

Once selected, the set display will be the active, permanent home screen. Refer to Figs 4.4.2 to 4.4.5.

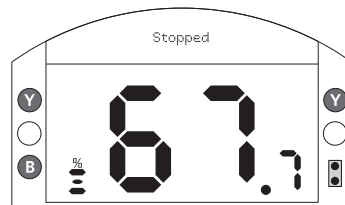

Fig. 4.4.2 Position

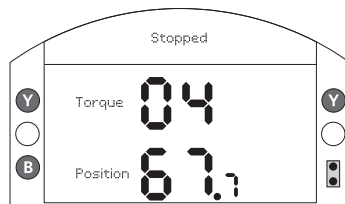

Fig. 4.4.3 Torque (D) + Position

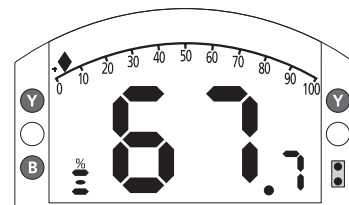

Fig. 4.4.4 Torque (A) + Position

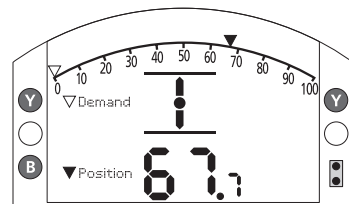

Fig. 4.4.5 Positioner

#### 4.5 Display Status Indication – Travel

The IQ display provides real-time status indication. The top line of the text area is reserved for travel status indication.

Fig 4.5.1 shows the travel status example of **CLOSED LIMIT**

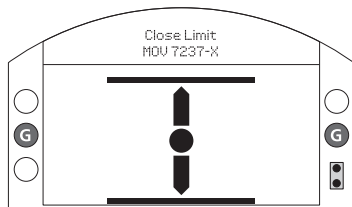

Fig. 4.5.1

#### 4.6 Display Status Indication – Control

The bottom line of the text area is reserved for control status indication and is displayed for approximately 2 seconds after the control mode or signal is applied.

Fig 4.6.1 shows the control status example **Remote Control**.

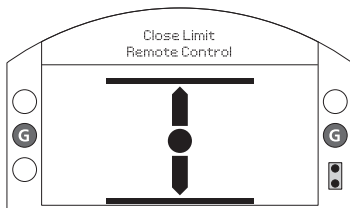



Fig. 4.6.1

#### 4.7 Display Alarm Indication

The IQ display provides alarm indication in the form of text and alarm icons.

There are 2 alarm icons:

General Alarm: 

Battery Alarm: 

The general alarm icon will be supported with text in the bottom line indicating the particular alarm, or if more than one is present, each alarm will be displayed in sequence.

Fig 4.7.1 shows the status example: **TORQUE TRIP CLOSED**

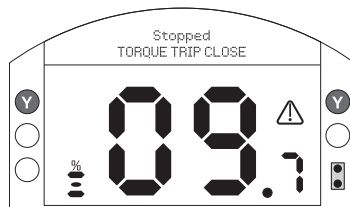

Fig. 4.7.1

#### 4.8 Battery Alarm

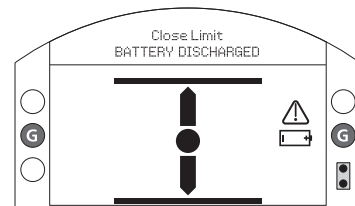

Fig. 4.8.1

The actuator checks the battery level at approximately 1 hour intervals. The battery alarm icon is displayed when the actuator detects its battery as being low and the display will indicate **BATTERY LOW**. If the battery is flat or missing the display will indicate **BATTERY DISCHARGED**.

When a low or discharged battery alarm is displayed the battery should be replaced immediately. It is essential that the correct battery type is fitted to maintain actuator certification. Refer to section 9 for details.

**After replacing a battery the alarm icon will continue to be displayed until the next check and may take up to 1 hour. Cycling the power will force a battery check and clear the alarm.**

## 5. Preparing the Drive Bush

### 5.1 IQ base all sizes types A and Z3

Turn actuator onto its side, remove the cap-headed screws holding retaining plate (1) onto the thrust base and pull out the drive bush (2) complete with its bearing assembly (3). Size IQ10 to 35 have 2 screws, size IQ40 to 95—F25 bases have 8 screws, and F30 have 10 screws. Before machining the drive bush the thrust bearing must be removed.

IQ10 to 18 actuators have a sealed thrust bearing located on the drive bush and retained by the split collar (4) and snap ring (5).

IQ20 to 95 have a thrust race bearing within a steel bearing housing located on the drive bush and retained by the split collar (4) and snap ring (5). The bearing is sealed within its housing by O-rings located on the drive bush and the bearing spacer ring (6).

**⚠ WARNING: Failure to remove the bearing assembly and O-rings from the drive bush prior to machining may result in damage to the bearing.**

### Disassembly of bearing assembly all sizes

Locate and remove the snap ring (5) using a suitable tool. Remove the split collar (4) See Fig. 5.1.1. Slide the bearing (3) off the drive bush (2).

Note Additional spacer (6) and O-rings to remove on sizes IQ20 to 95.

Keep the bearings and drive bush locating components in a safe clean place. The split collar (4) must be kept as a matched pair.

Machine the drive bush (2) to suit the valve stem, allowing a generous clearance on the screw thread for rising steam threads.



Fig. 5.1.1



Fig. 5.1.2 F10 base assembly

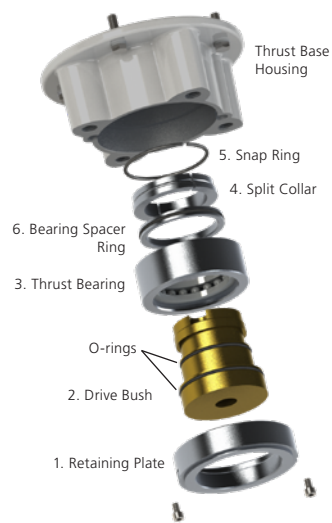

Fig. 5.1.3 F14 & F16 base assembly



Fig. 5.1.4 F25 & F30 base assembly

## Reassembly

**⚠ WARNING: Failure to fully clean and grease the drive bush and O-rings before reassembly could result in damage.**

Remove all swarf from the drive bush (2) ensuring all O-rings are undamaged, clean and greased (for typical greases refer to Section 11, weights and measures).

Slide the bearing assembly (3) onto the drive bush (2) and ensure it is fitted down to the drive bush shoulder. On size IQ20 to IQ95 refit bearing spacer ring (6) into bearing assembly ensuring O-ring is fitted and greased. Grease and refit matched pair split collar (4) and snap ring (5).

Grease and refit the drive bush bearing assembly into the thrust base housing on the actuator, ensuring that the slots in the drive bush are located into the drive dogs of the hollow output shaft.

Refit the retaining plate (1) and secure with cap headed screws. For IQ40 to IQ95 tighten base retaining screws to the following torque values:

F25 / FA25 Base — 8 off / M12 cap head screws: 89 Nm / 65 lbs.ft

F30 / FA30 Base — 10 off / M16 cap head screws: 218 Nm / 160 lbs.ft

## 5.2 Non-Thrust Base Type B

### All Sizes

Undo the hex head bolts securing the base plate to the gearcase and remove the base plate.

The drive bush and its retaining clip can now be seen. The plate will vary with the size of the actuator. See Fig. 5.2.1.



Fig. 5.2.1



Fig. 5.2.2

### Types B3 and B4 Removal

Using external circlip pliers, expand the circlip while pulling on the drive bush. The drive bush will detach from the actuator centre column with the circlip retained in its groove. Refer to Fig. 5.2.2.

### Types B1 Removal

The procedure for removal and refitting of the B1 drive bush is the same as for B3 and B4, however the circlip is replaced with a custom spring circlip. The spring operates in the same manner as the B3/B4 circlip but is expanded using long nose-pliers. Refer to Fig. 5.2.3.



Fig. 5.2.3

## 6. Mounting the Actuator

### **⚠ Refer to Section 11 Weights and Measures for actuator weight.**

Ensure the valve is secure before fitting the actuator as the combination may be top heavy and therefore unstable.

If it is necessary to lift the actuator using mechanical lifting equipment certified slings should be attached as indicated in Fig. 6.2.1 for vertical shafts and Fig. 6.2.2 for horizontal shafts.

At all times trained and experienced personnel should ensure safe lifting particularly when mounting actuators.

### **⚠ WARNING: The actuator should be fully supported until full valve shaft engagement is achieved and the actuator is secured onto the valve flange.**

A suitable mounting flange conforming to ISO 5210 or USA Standard MSS SP101 must be fitted to the valve.

Actuator to valve fixing must confirm to Material specification ISO Class 8.8, yield strength 628 N/mm<sup>2</sup>.

**⚠ WARNING: IQ Cover Tubes.** Cover tubes not supplied by Rotork shall be designed to ensure that they do not exceed BOTH mass and moment parameters listed in Section 11 Weights and Measures.

**⚠ WARNING: Do not lift the actuator and the valve combination via the actuator. Always lift the valve/actuator assembly via the valve.**

Each assembly must be assessed on an individual basis for lifting.

**⚠ WARNING: If the actuator orientation when installed is inverted (base up), additional oil is required to ensure adequate lubrication. The user should top up the oil by the quantity stated in the table under section 11 Weights and Measures. Failure to do will cause premature wear.**



Fig. 6.2.1



Fig. 6.2.2

## 6.1 Rising Stem Valves Top Mounted

### Fitting the Actuator and Base as a combined unit, all sizes.

Fit the machined drive bush into the thrust base as previously described, lower the actuator onto the threaded valve stem, engage **HAND** operation and wind the hand wheel in the open direction to engage the drive bush onto the stem. Continue winding until the actuator is firmly down onto the valve flange. Wind two further turns, fit securing bolts and tighten fully to the required torque indicated in Table B.

### Fitting Thrust Base to Valve Actuator

Fit the machined drive bush into the thrust base as previously described. Remove the thrust base from the actuator, place it on the threaded valve stem with the slotted end of the drive bush uppermost and turn it in the open direction to engage the thread. Continue turning until the base is positioned onto the valve flange. Fit the securing bolts but do not tighten at this stage. Lower the actuator onto the thrust base and rotate the complete actuator until the drive dogs on the actuator output shaft engage into the drive bush. Actuator flange should now be flush with the base.

Continue to turn actuator until fixing holes align. Using bolts supplied fix actuator to thrust base and tighten down to required torque, see table A.

Open valve by two turns and firmly tighten down onto valve flange to the required torque, see table B.



Fig. 6.1.1

Size	Torque ( $\pm 10\%$ )	
	Nm	lbs.ft
M8	13.8	9.8
M12	45.9	33.8
M16	101	74

Fig. 6.1.2 Table A

Metric		Torque	
Flange	Fixing	Nm	lbs.ft
F10	M10	51.6	38
F14	M16	219.8	162.1
F16	M20	430.5	317.5
F25	M16	219.8	162.1
F30	M20	430.5	317.5
Imperial		Torque	
Flange	Fixing	Nm	lbs.ft
FA10	$\frac{3}{8}$	42.3	31.2
FA14	$\frac{5}{8}$	205.3	151.4
FA16	$\frac{3}{4}$	363.6	268.1
FA25	$\frac{5}{8}$	205.3	151.4
FA30	$\frac{3}{4}$	363.6	268.1

Fig. 6.1.3 Table B

## 6.2 Valve with Gearbox – Side Mounting

Check that the mounting flange is at right angles to the input shaft, and that the drive bush fits the shaft and key with adequate axial engagement. Engage **HAND**, offer up actuator to the input shaft and turn handwheel to align keyway and key. Tighten mounting bolts to the required torque indicated in Table B.

## 6.3 Non-Rising Stem Valves – Top Mounting

Treat as for side mounting except that when thrust is taken in the actuator, a thrust nut must be fitted above the drive bush and securely tightened.

## 6.4 Handwheel Sealing

Ensure that the sealing cap and O-ring is fitted securely to ensure that moisture does not pass down the centre column of the actuator. For valves with rising spindles a cover tube may be fitted, this must also be sealed with an O-ring and secured with cap screws.



Fig. 6.4.1



Fig. 6.4.2

## 6.5 IQM Modulating Actuators

The IQM range of actuators are suitable for modulating control duty of up to 1,200 starts per hour.

IQM have a dynamic braking facility as standard. If mechanical overrun of the actuator and valve prove to be excessive for accurate control, the brake can be enabled. With dynamic braking enabled, motor heating effects increase and therefore the number of starts may require reducing to prevent motor thermostat tripping.

Commissioning of the IQM range is identical to the standard IQ - refer to Section 8.

## 6.6 IQL & IQML Linear Drive Unit

Consists of a lead screw assembly arrangement attached to the base of the actuator in order to provide a linear output stroke between 8 mm ( $\frac{3}{4}$  in) minimum and 110 mm ( $4\frac{1}{4}$  in) maximum.

The IQL/IQML actuator can be supplied with or without a yoke mounting adaptor. The adaptor consists of four pillars and a base flange to suit the valve.

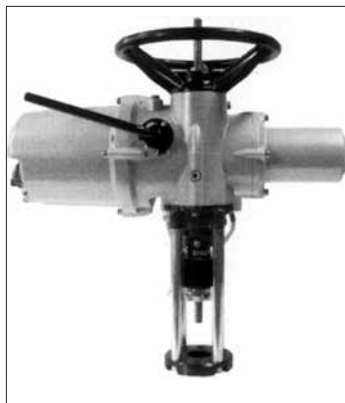

Fig. 6.6.1 IQML with Yoke

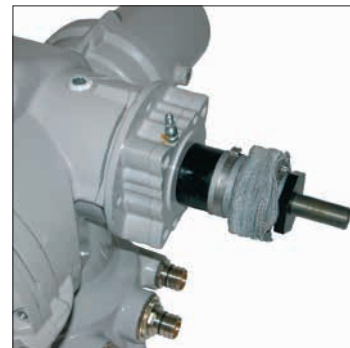

Fig. 6.6.2 IQML without Yoke



## 6.7 IQL & IQML Adjusting Linear Stroke

With the actuator securely fitted to the valve, but with the linear drive disconnected ensure valve is at its fully closed (down) position.

Remove cover tube from actuator handwheel, locate the down stop adjustment on the linear drive unit and with two spanners loosen the lock nut, run the lock nut and tubular down stop anti-clock wise to the end of the thread.



Fig. 6.7.1

Turn the actuator handwheel clockwise, the linear drive will move down towards the valve spindle and

couple the linear drive to valve spindle. Turn the tubular down stop clockwise into the actuator until it comes to a mechanical stop. If the valve must close into its seat by TORQUE ACTION then back off (anticlockwise) the down stop by one third of one turn (equivalent to 1 mm). Run the lock nut down onto the tubular down stop and tighten with two spanners. There is no UP STOP (open) on the linear drive unit, the mechanical stop in the valve will give this position. Refit the cover tube onto the handwheel ensuring the O-ring is fitted.

The linear drive unit is pre-packed with extreme pressure multi-purpose grease MULTIS MS2, use this or an equivalent high temperature grease.

A grease nipple is situated in the base of the actuator to enable lubrication of the lead screw.

Periodically, depending on usage and temperature, apply two pumps of the grease gun.

## 7. Cable Connections

### 7.1 Terminal Block Layout

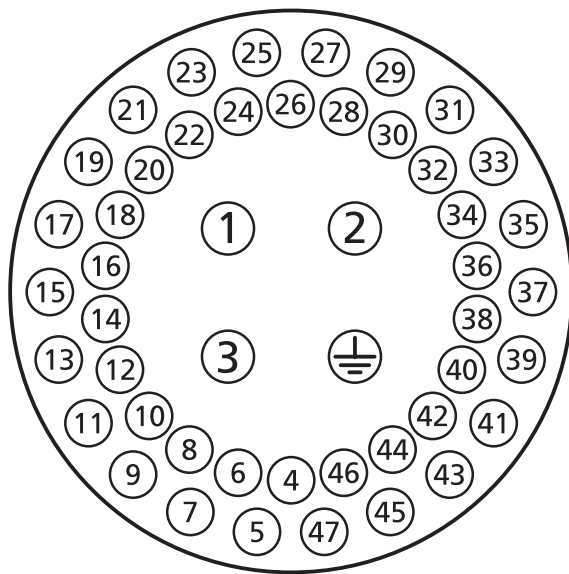

Fig. 7.1.1 Terminal numbers refer to connections as shown on the actuator circuit diagram

**⚠ WARNING: Ensure all power supplies are isolated before removing actuator covers.**

Check that the supply voltage agrees with that stamped on the actuator nameplate.

A switch or circuit breaker must be included in the wiring installation or the actuator. The switch or circuit breaker must meet the relevant requirements of IEC60947-1 and IEC60947-3 and be suitable for the application. The switch or circuit breaker must not disconnect the protective earth conductor. The switch or circuit breaker must be mounted as close to the actuator as possible and shall be marked to indicate that it is the disconnect device for that particular actuator. The actuator must be protected with overcurrent protection devices rated in accordance with the applicable electrical data publication:

- PUB002-099 (3-phase actuators)
- PUB002-019 (single-phase actuators)
- PUB002-120 (3-phase modulating actuators)
- PUB002-121 (DC actuators)

**⚠ WARNING: Actuators for use on phase to phase voltages greater than 600 V must not be used on supply systems such as floating, or earth-phase systems, where phase to earth voltages in excess of 600 VAC could exist.**

Power supply cables must have sufficient mechanical protection properties to meet installation requirements and be screened to comply with EMC requirements of the installed actuator. Suitable methods include armoured and/or screened cables or cables contained within conduit.

## 7.2 Earth/Ground Connections

A lug with a 6.5 mm diameter hole is cast adjacent to the conduit entries for attachment of an external protective earthing strap by nut and bolt. An internal earth connection is also provided however it must not be used alone as the Protective Earth Connection.

## 7.3 Removing Terminal Cover

Using a 6 mm Allen key loosen the four captive screws evenly. Do not attempt to lever off the cover with a screw driver this will damage the O-ring seal and may damage the flamepath on a certified unit.



Fig. 7.3.1

The Rotork Bluetooth® Setting Tool Pro is packed separately, with the actuator, in the shipping box identified with a yellow label.

The wiring code card fixed in the cover is particular to each actuator and must not be interchanged with any other actuator. If in doubt check the serial number on the code card with that of the actuator.



Fig. 7.3.2 Actuator terminal compartment and Bluetooth® Setting Tool Pro (Packed separately in shipping box).

A plastic bag in the terminal compartment contains:

- Terminal screws and washers.
- Spare cover O-ring seal.
- Wiring diagram.
- Instruction book.



ATTENTION: RED PLASTIC PLUGS IN CONDUIT ENTRIES ARE FOR TRANSIT ONLY.  
FOR LONG TERM PROTECTION FIT SUITABLE METAL PLUGS.

ATTENZIONE: I TAPPI IN PLASTICA ROSSA PER L'ENTRATA CAVI SONO SOLO  
TEMPORANEI. PER UNA PROTEZIONE PERMANENTE PREGO SOSTITUIRLI CON APPOSITI  
TAPPI METALLICI.

ATENCIÓN: LOS TAPONES ROJOS DE PLASTICO EN LAS ENTRADAS DE CABLE SON  
UNICAMENTE PARA TRANSPORTE. PARA PROTECCION PERMANENTE COLOCAR  
TAPONES METALICOS APROPIADOS.

ACHTUNG: DIE ROTEN PLASTIKSTOPFEN SIND NUR FÜR DEN TRANSPORT GEEIGNET.  
FÜR DAVERHAFTEN SCHUTZ SIND DIESE GEGEN GEEIGNETE BLINDSTOPFEN  
AUSZÜTAUSCHEN.

ATTENTION: LES BOUCHONS PLASTIQUES ASSURENT UNE PROTECTION TEMPORAIRE.  
POUR UNE PROTECTION DEFINITIVE UTILISER DES BOUCHONS METALLIQUES.

注意：コンジット口の赤色プラグは、輸送用を目的としたプラグです。  
長期に渡る保護の場合、適切なメタルプラグをご使用ください。

注意：接线端红色塑料封口仅为运输途中使用。  
长期正常保护时请用金属封口。

주의: 배선인입구의 빨간색 플라스틱 플러그는 오직 임시용입니다.  
오래 보관하기 위해서는 규격에 맞는 금속 플러그를 사용하십시오.



#### 7.4 Cable Entry

Only appropriate certified explosion proof cable glands or conduit may be used in hazardous locations. The cable entries in the actuator are tapped M25 x 1.5p or M40 x 1.5p.

In hazardous locations, only one appropriate certified Explosion-Proof thread adaptor per entry may be used.



Fig. 7.4.1



Fig. 7.4.2

Remove plastic transit plugs. Make cable entries appropriate to the cable type and size.

Ensure that threaded adaptors, cable glands or conduit are tight and fully waterproof. Seal unused cable entries with steel or brass threaded plug. In hazardous areas an appropriate certified threaded blanking plug must be installed at the cable entry without the use of an interposing thread adaptor.

#### 7.5 Connecting to Terminals

Field wiring connections are by wire termination ring/spade tags. If necessary, suitable insulation must be applied to bare metal ring/spade tags in order to ensure adequate separation between 'hazardous live' and non-hazardous' live circuits considering, and in accordance with, national regulations and statutory provisions.

Tags are secured with the supplied 4 mm (control and indication) and 5 mm (power) pan head screws.

⚠ To ensure secure electrical connections, it is important that the requisite washers are used as shown in Figure 7.5.1. Failure to do so may result in connections working loose or screws not clamping down on wire termination tags. Spring washers must be compressed. Screw tightening torques must not exceed 1.5 Nm (1.1 lbf.ft)

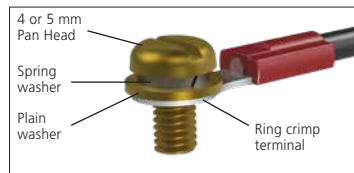

Fig. 7.5.1

⚠ To comply with Ex e certification, terminals numbered 1 - 3 and earth must be fitted with 1 off AMP ring crimp terminal 160292 per terminal and terminals numbered 4 - 47 must be fitted with 1 off AMP ring crimp terminal 34148 per terminal when required.

Refer to the wiring diagram inside the terminal cover to identify functions of terminals. Check the supply voltage is the same as that marked on the actuator nameplate.

Remove power terminal guard.

Begin by connecting power cables and replace guard. When all connections are made ensure wiring diagram is replaced in the terminal compartment.

⚠ **WARNING: Wiring can reach 80 °C in a 70 °C ambient temperature. For safety reasons the same voltage level must be connected to all the actuator's indication terminals, remote input terminals and digital I/O terminals (if applicable).**

All external circuits must be provided with insulation suitable for the rated voltage whilst considering national regulations and statutory provisions.

## 7.6 Replacing Terminal Cover

Ensure cover O-ring seal and spigot joint are in good condition and lightly greased before refitting cover.

## 8. Commissioning - Basic Settings

All actuator settings, Datalogger and asset management data is accessed using the supplied Rotork Bluetooth® Setting Tool *Pro*. Status and alarm data in addition to that shown on the home screen can also be accessed.

**THE CONTROL COVER MUST NOT BE REMOVED; NO USER CONFIGURABLE SETTINGS ARE AVAILABLE WITHIN THE CONTROL ENCLOSURE. THE CONTROL COVER IS SEALED BY A QUALITY LABEL WHICH IF BROKEN MAY INVALIDATE WARRANTY.**

This instruction details the basic settings that must be completed before the actuator is put into service.

**ELECTRICAL OPERATION MUST NOT TAKE PLACE UNTIL THE BASIC SETTINGS HAVE BEEN MADE AND CHECKED.**

The basic settings affect the correct operation of the valve by the actuator. If the actuator has been supplied with the valve, the valvemaker or supplier may have already made these settings.

⚠ Settings and operation must be verified by electric operation and function test of the actuated valve.

**THIS PUBLICATION PROVIDES INSTRUCTION ON MAKING THE BASIC SETTINGS ONLY.**

For instruction on control and indication settings and for information on diagnostics refer to PUB002-040.

## 8.1 Connecting to the Actuator

The Rotork Setting Tool incorporating Bluetooth wireless technology (Rotork Bluetooth® Setting Tool Pro – BTST) is shown below. It is identified by the key symbols being clear and a clear seal between the top and bottom casings.

The Infra-red only tool has filled yellow keys and a yellow seal between casings.



The Rotork Bluetooth® Setting Tool Pro with the relevant navigation and configuration keys is shown below.

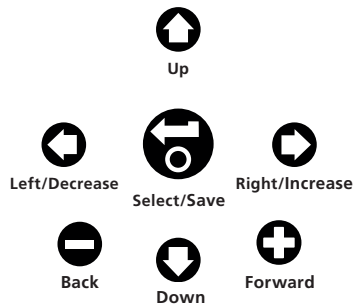

### Connecting to the actuator using Bluetooth

The default security set in the actuator for Bluetooth connection is by initiation using an infra red command. This means that the user must be in close proximity and in direct line of sight of the actuator.

Point the setting tool at the actuator display window within a range 0.25 m (10 in) and Press  key.

The screen will change to the Main Menu screen.

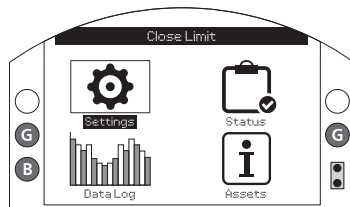



Fig. 8.1.1

**The Setting Tool will automatically connect using Bluetooth which takes up to 5 seconds and when connected will be indicated by blue lights illuminating on the tool and in the actuator display window. Once connected, the tool can be used without pointing it at the actuator display window.**

Bluetooth connection will be maintained while setting tool key commands are made. After a period of 6 minutes with no key commands, Bluetooth connection will be turned off and the Setting tool and display blue lights will go out. To manually turn off Bluetooth connection at any time, press the setting tool  and  keys together.

## 8.2 Security - Password

The default security level for connecting to the actuator is by infra-red Bluetooth initiation. This requires that the user is at the actuator within 0.25 metre distance and in direct line of sight of the display. For instruction on connecting to the actuator refer to 8.1.

All actuator settings can be viewed with the actuator selected to Local, Stop or remote.

**To change an actuator setting, the actuator must be selected to Local or Stop and a correct password entered.**

If the actuator is selected to Remote and a setting is selected, the following warning will be displayed:

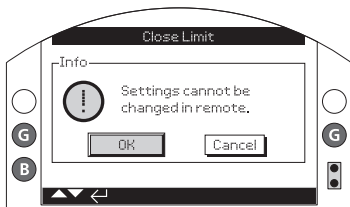

Fig. 8.2.1

Select OK to return to settings screen.

With the actuator selected to Local or Stop and when any function is selected, the Password screen will be displayed:

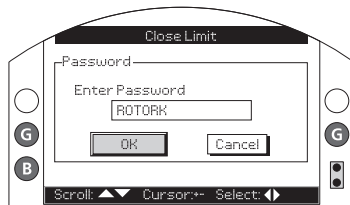

Fig. 8.2.2

**The factory set default password ROTORK is displayed and the OK key is highlighted.**

Press the  key.

The setting screen will again be displayed. The example below shows **Settings – Limits – Close Settings** with the function **Action** highlighted:

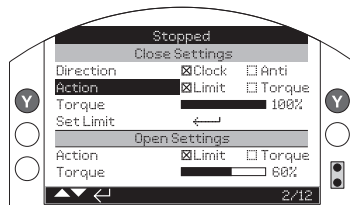

Fig. 8.2.3

Press the  key to select.

The function and its setting option or range will then be highlighted:

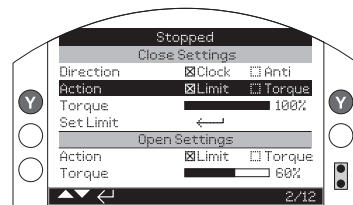



Fig. 8.2.4

**If the user does not wish to change the function value, press the back button to escape without changing.**

Use the  or  arrow keys to change the setting to the required value, the example below show a close action of *Torque* having been selected.

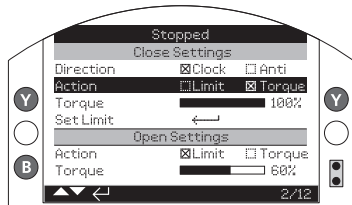

Fig. 8.2.5

Press the  key to select.

The highlight will return to the function name only and its stored setting will be displayed:

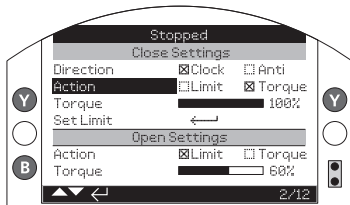
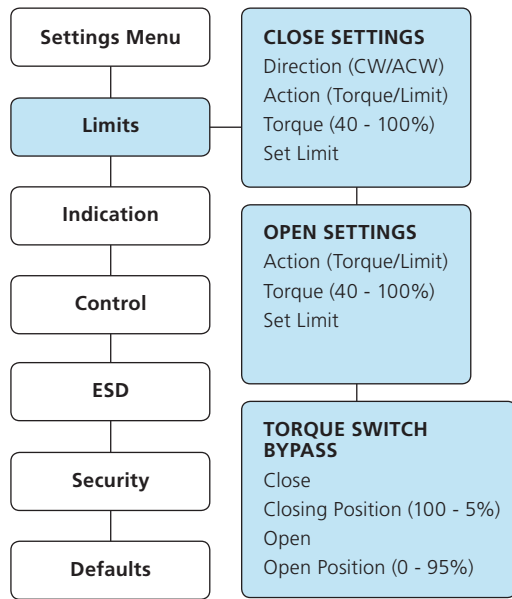

Fig. 8.2.6

The password will be requested the first time a function is selected. Once correctly entered, the password will not be required to be entered again for the duration of setting tool communication with the actuator. Other functions can be set as required.

### 8.3 Basic Settings Menu





## 8.4 Basic Settings – Limits

**⚠ Settings and operation must be verified by electric operation and function test of the actuated valve.**

Connect to the actuator as described in Section 8.1. From the Position display home screen press the **⏏** key. The main menu will be displayed.

Navigate to Settings using the **⏏** **⏏** **⏏** **⏏** keys and press **⏏** to select.

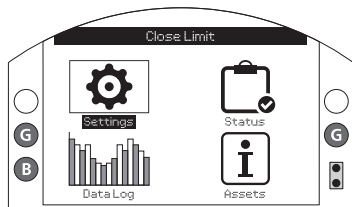

Fig. 8.4.1

The settings menu will be displayed:

Settings	
Limits	
Indication	
Control	
ESD	
Security	
Defaults	

Navigate to Limits using the **⏏** **⏏** keys and press **⏏** to select.

**The setting first selected to be changed will require a password to be entered – refer to section 8.2.**

The limit settings are shown below with their factory default values:



Limits	
Close Settings	
1 / 15	Direction <input checked="" type="checkbox"/> Clock <input type="checkbox"/> Anti
2 / 15	Action <input checked="" type="checkbox"/> Limit <input type="checkbox"/> Torque
3 / 15	Torque <input type="text" value="40%"/>
4 / 15	Set Limit <input type="text" value="←"/>
Open Settings	
5 / 15	Action <input checked="" type="checkbox"/> Limit <input type="checkbox"/> Torque
6 / 15	Torque <input type="text" value="40%"/>
7 / 15	Set Limit <input type="text" value="←"/>
8 / 15	Turns <input type="text" value="25"/>
9 / 15	Position <input type="text" value="95.0"/>
10 / 15	
Torque Switch Bypass	
11 / 15	Opening <input type="checkbox"/> On X <input checked="" type="checkbox"/> Off
12 / 15	OP. Bypass Pos <input type="text" value="10%"/>
13 / 15	Closing <input type="checkbox"/> On X <input checked="" type="checkbox"/> Off
14 / 15	CL. Bypass Pos <input type="text" value="90%"/>
15 / 15	
1 / 15	

Function Close Direction (1 / 15) is shown highlighted. Use **⏏** **⏏** to scroll through functions. Functions will be highlighted in turn. Blank settings are IQT only.

## 8.5 Close Settings

### 1 / 15. Close Direction

Function sets the direction required to close the valve. Manually operate the actuator and valve to establish closing direction.





Press  to select Close Direction function. Use  or  to check required setting. Press  to set.

### 2 / 15. Close Action

The actuator can be configured close on torque for seating valve types or limit for non-seating valve types.

 **Refer to Valve manufacturer for recommended setting. In the absence of valvemaking instruction refer to the following table.**

Valve Type	Close Action	Open Action
Wedge gate	Torque	Limit
Globe	Torque	Limit
Butterfly	Limit	Limit
Through Conduit	Limit	Limit
Ball	Limit	Limit
Plug	Limit	Limit
Sluice gate	Limit	Limit
Penstock	Limit	Limit
Parallel Slide	Limit	Limit

Press  to select Close Action function. Use  or  to check required setting. Press  to set.

### 3 / 15. Close Torque

The value of torque available to close the valve can be set between 40% and 100% of rated. The actuator rated torque value is shown on its nameplate.

Press  to select Close Torque function. Use  key to decrease value and  key to increase value.

Press  key to set.

### 4 / 15 Set Close Limit

Press  to select Close Limit Function. The actuator will display the following Instruction:

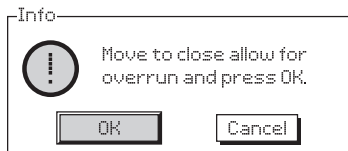

Fig. 8.5.1

Move the actuator and valve to the close position. Allow for overrun by winding in the opening direction by  $\frac{1}{2}$  to 1 turn.





Press  to set the close limit position.

## 8.6 Open Settings

### 5 / 15. Open Action

The actuator can be configured open on torque for seating valve types or limit for non-seating valve types.

 **Refer to Valve manufacturer for recommended setting. In the absence of valvemaking instruction set open action to "Limit".**

Press  to select Open Action function. Use  or  to check required setting. Press  to set.

### 6 / 15. Open Torque

The value of torque available to open the valve can be set between 40% and 100% of rated. The actuator rated torque value is shown on its nameplate.

Press  to select Open Torque function. Use  key to decrease value and  key to increase value.

Press  to set.

## 7 / 15. Set Open Limit

Press  to select Open Limit Function. The actuator will display the following instruction:

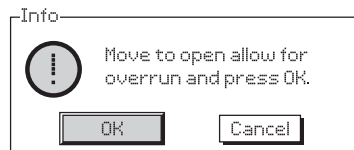



Fig. 8.6.1

Move the actuator and valve to the open position. Allow for overrun by winding in the closing direction by  $\frac{1}{2}$  to 1 turn.

Press  to set the open limit position.

## 8 / 15. Turns (not editable)

Shows the actuator output turns between the set Closed and Open limit positions.

## 9 / 15. Position (not editable)

Shows the actuator current position in terms of % open.

**Note: Turns and Position values do not update while being displayed on screen. To see updated values, use  key to return to Settings Menu, then select Limits.**

## 8.7 Torque Switch Bypass

The default setting for opening and closing torque switch bypass is Off (torque protection active at all times). Bypassing the torque protection allows torque up to approximately 150% of rated to be available. The valvemaker/integrator should be consulted to confirm the valve structure and interface components can withstand the additional torque/thrust.

### 11 / 15. Opening





Opening torque protection can be bypassed over a configurable portion of the opening stroke. When enabled, torque up to approximately 150% of rated torque is available for opening "sticky" valves.

Press  to select Opening Torque Switch Bypass function. Use  or  to check required setting.

Press  to set.



### 12 / 15. Opening Bypass position

When enabled (refer to 11 / 15), the position over the opening stroke where the torque protection is bypassed can be configured in the position range 0% (closed limit) to 95% open. Outside the bypass position, torque switch value will revert to that set, refer to 6 / 15.

Press  to select Opening Bypass Position function. Use  key to decrease value and  key to increase value. Press  to set.

### 13 / 15. Closing





Closing torque protection can be bypassed over a configurable portion of the closing stroke. When enabled, torque up to approximately 150% of rated torque is available for closing the valve. Outside the bypass position, torque switch value will revert to that set, refer to 3 / 15.

Press  to select Closing Torque Switch Bypass function. Use  or  to check required setting.

Press  to set.

### 14 / 15. Closing Bypass position

When enabled (refer to 13 / 15), the position over the Closing stroke where the torque protection is bypassed can be configured in the position range 100% (open limit) to 5% open.

Press  to select Closing Bypass Position function. Use  key to decrease value and  key to increase value. Press  to set.

## 9. Maintenance, Monitoring and Troubleshooting

### Maintenance

Every Rotork actuator has been fully tested before dispatch to give years of trouble-free operation providing it is installed, sealed and commissioned in accordance with the instructions given in this publication.

The IQ actuator's unique double sealed, non-intrusive enclosure provides complete protection for the actuator components.

The IQ actuator gearing is located in an oil bath and is lubricated for life and does not need replenishing. Should the oil be removed or lost it must not be electrically operated as premature failure may result.

Covers should not be removed for routine inspection as this may be detrimental to the future reliability of the actuator.

The electrical control module cover is bonded by the Rotork quality control seal. It should not be removed as the module contains no site-serviceable components.

All electrical power supplies to the actuator must be isolated before any maintenance or inspection is carried out, except replacement of the battery.

Electrical supplies must be isolated before

actuator covers are removed – refer to battery replacement instructions.

Routine maintenance should include the following:

- Check actuator to valve fixing bolts for tightness.
- Ensure valve stems and drive nuts are clean and properly lubricated.
- If the motorised valve is rarely operated, a routine operating schedule should be set up.
- Replace actuator battery every 5 years.
- Check the actuator enclosure for damage, loose or missing fasteners.
- Ensure there is not an excessive build up of dust or contaminant on the actuator.
- Check for any loss of lubricant. (refer to section 11 for lubricants).

### The Actuator Battery

The battery supports the actuator valve position indication relays, datalogger and the position display (LCD) only when the main power supply is turned off. It ensures the current position is indicated and displayed when manual operation takes place.

The battery is not required to retain any actuator settings or track position changes.

With mains power switched off and without a battery fitted or when discharged, all configured settings are retained safely in EEPROM and position changes are tracked by the absolute encoder.

On power up, the correct, current position will be displayed and the actuator will operate normally.

**⚠ WARNING: The battery holder in the actuator gearcase also protects the user from the hazardous live connections inside the actuator and therefore it must not be damaged. The actuator must be isolated or disconnected if the battery holder has to be removed from the actuator gearcase.**

A unique circuit has been incorporated into the battery function of the IQ, effectively reducing the overall drain and significantly increasing the battery life.

**In normal circumstances battery replacement interval should not exceed 5 years. Ambient temperature and plant operating conditions may affect battery life.**

Battery level status is indicated by an icon on the actuator display – refer to section 4.3.

If the battery icon is displayed the battery should be replaced to ensure correct power off valve position indication.

### ⚠ WARNING: Battery Replacement

**If the actuator is located within a hazardous area permission must be obtained in the form of a "hot work permit" or other local regulation before removal and/or replacement of the battery.**

Removal of the battery with the main electrical power switched off will result in stored datalogger records time reference being lost for the duration when there is no mains and battery power. It is therefore recommended that the battery is replaced with the main electrical supply to the actuator switched on.

### Battery Removal

The actuator must be selected to Stop using the red selector – refer to section 4.2. Access to the battery is via a labelled sealing plug situated on the main gearcase near the handwheel hub.

Remove the sealing plug using the appropriate Allen key, ensuring the O-ring seal remains on the plug. Disconnect the battery wiring loom from the battery terminals. Using the black pull strap, lift the battery out of the rubber sealing pocket.



Fig. 9.7.1

### Battery Types

For European hazardous area certified actuators (ATEX / IEC Ex) use a lithium manganese dioxide battery as stated in Fig. 9.7.2 Battery Type Table.

For FM and CSA certified enclosures use an Ultralife U9VL lithium manganese dioxide battery. Equivalent, UL recognised, batteries may be used.

For watertight (WT) actuator enclosures Rotork recommend a lithium manganese dioxide battery, however any equivalent 9V battery may be used.

If in doubt regarding the correct battery type, contact Rotork.

Enclosure Type	Battery Type	Detail
ATEX/IEC Ex - Standard Temp	Ultralife PP3 Types	U9VL or U9VL-J-P
ATEX/IEC Ex - Low/High Temp	Rotork Part Numbers:	95-462 or 95-614

Fig. 9.7.2 Battery Type Table

### Fitting Replacement Battery

Fit the pull strap around the replacement battery and insert into the rubber sealing pocket. Reconnect the battery wiring loom to the battery terminals. Refit the battery sealing plug ensuring O-ring is in good condition and correctly fitted. Hand tighten the sealing plug to 8 Nm (6 lbs/ft) using the appropriate Allen key.

### Oil

Unless specially ordered for extreme climatic conditions, Rotork actuators are dispatched with gearcases filled with SAE 80EP oil which is suitable for ambient temperatures ranging from -30 to +70 °C (-22 to +160 °F).

IQ actuators do not require regular oil changes (refer to Section 11, Weights and Measures).

### Torque and Position Monitoring

The IQ range of actuators incorporate real time, instantaneous Torque & Position monitoring as standard. Torque & Position can be used to monitor valve performance during operation. The effect of process changes (differential pressure etc.) can be evaluated, tight spots in valve travel can be pinpointed as well as gauging the torque developed through stroke

in order to set appropriate open and closed torque switch settings.

**There a two home screen displays that indicate torque and position simultaneously. Refer to section 4.4**

### Analogue Torque and Position indication

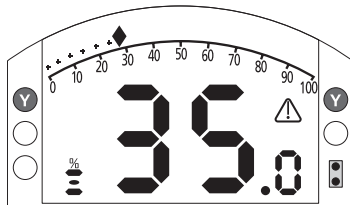

Fig. 9.7.3

Example shows that actuator at 35.0% open, producing 27% of rated torque. The warning triangle indicates the actuator has torque tripped.

Note: The torque and position values displayed are dynamic and will show the actual torque and position values currently measured. After a torque trip, the torque value tends to drop away as the internal mechanical components relax as no drive is present.

### Digital Torque and Position indication

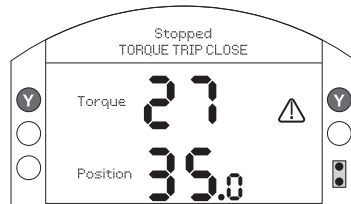

Fig. 9.7.4

Example shows that actuator at 35.0% open, producing 27% of rated torque. The status bar and warning triangle indicate that the actuator has torque tripped when closing.

Note: The actuator will torque trip and stop when the value of torque reaches that set for the open (when opening) and closing (when closing) torque switches (refer to 8.5 and 8.6). Due to the effects of inertia (variable with speed/load) and valve resilience, the torque delivered and displayed may be higher.

## 10. Decommissioning and Environmental Considerations

End user advice on disposal at end of life of the product.

In all cases check local authority regulation before disposal.

The actuator can be removed by reversing the operations detailed in the mounting and cabling sections.

All warnings as detailed in the mounting and cable connection sections must be followed. Disposal of the actuator or any of its components should be done in accordance with the table below.

**⚠ WARNING: It is essential that the actuator is not subject to any valve / system loads at the time of removal as this could cause operator injury due to the actuator moving unexpectedly.**

Subject	Definition	Remarks / examples	Hazardous	Recyclable	EU Waste Code	Disposal
Batteries	Lithium	IQ battery	Yes	Yes	16 06 06	Will require special treatment before disposal, use specialist recyclers or waste disposal companies
	Alkaline	Setting tool	Yes	Yes	16 06 04	
Electrical & Electronic Equipment	Printed circuit boards	All Products	Yes	Yes	20 01 35	Use specialist recyclers
	Wire	All Products	Yes	Yes	17 04 10	
Glass	Lens/Window	IQ	No	Yes	16 01 20	Use specialist recyclers
Metals	Aluminium	Gearcases and covers	No	Yes	17 04 02	Use licensed recyclers
	Copper/Brass	Wire, IQ gears, motor windings	No	Yes	17 04 01	
	Zinc	IQ clutch Ring and associated components	No	Yes	17 04 04	
	Iron/Steel	Gears and bases	No	Yes	17 04 05	
	Mixed Metals	IQ motor rotors	No	Yes	17 04 07	
Plastics	Glass filled nylon	Covers, electronics chassis	No	No	17 02 04	Disposal as general commercial waste
	Unfilled	Gears	No	Yes	17 02 03	Use specialist recyclers
Oil /Grease	Mineral & Kerosene Mixed	Gearbox lubrication	Yes	Yes	13 07 03	Will require special treatment before disposal, use specialist recyclers or waste disposal companies
	Mineral	Gearbox lubrication	Yes	Yes	13 02 04	
	Food Grade	Gearbox lubrication	Yes	Yes	13 02 08	
	Grease	Side Handwheel / linear drive	Yes	No	13 02 08	
Rubber	Seals & O-rings	Cover and shaft sealing	Yes	No	16 01 99	May require special treatment before disposal, use specialist waste disposal companies

## 11. Weights and Measures

### Lubricating oil

Refer to actuator name plate. IQ actuators are lubricated using the oil grades specified below. They are factory filled for life and in normal service do not require topping up.

Ambient temperatures ranging from -30 to 70 °C (-22 to 160 °F): SAE 80EP lubricating oil.

Ambient temperatures below -30 °C (-22 °F): Mobil SHC 624 lubricating oil.

### Food grade lubricating oil

If user specified, IQ actuators will be filled with Hydralube GB Heavy food grade lubricating oil suitable for temperature range -30 to 70 °C (-22 to 160 °F).

### Grease – Side handwheels

Extreme pressure multipurpose grease MULTIS MS2 or equivalent. For low temperatures use a grease suitable for use at -50 °C such as Optitemp TT IEP.

### Grease – Linear drive unit

IQL and IQML linear drive assemblies should be regularly lubricated using extreme pressure multi-purpose grease MULTIS MS2 or equivalent.

### Grease – Base assembly

O-rings use either Multis EP2 / Lithoshield EP2 or equivalent for all temperature ranges between -50 and +70 °C (-58 and +158 °F).

### Standard weight and lubricating oil capacities:

Actuator Size	Weight kg (lbs)	Oil Capacity litres (pt.-US)
IQ10	31 (68)	1.25 (2.64)
IQ12	31 (68)	1.25 (2.64)
IQ18	31 (68)	1.25 (2.64)
IQ19	54 (119)	1.9 (4.0)*
IQ20	54 (119)	1.9 (4.0)*
IQ25	54 (119)	1.9 (4.0)*
IQ35	75 (165)	2.4 (5.1)
IQ40	145 (320)	3.7 (7.8)
IQ70	145 (320)	3.7 (7.8)
IQ90	160 (353)	3.7 (7.8)
IQ91	150 (331)	3.7 (7.8)
IQ95	160 (353)	3.7 (7.8)

**\*Oil capacity shown for Top Hand Wheel actuators. Side Hand Wheel actuator capacity is 2.20 (4.65).**

### Inverted installation

If inverted installation (base uppermost) was specified with the order, Rotork will oil fill to the quantities shown in the table below and the actuator will be labelled "Factory filled with additional oil for inverted use". If not specified with order but site installation will be inverted, to ensure adequate lubrication the installer must top up the oil before installation using the top oil plug by the amount indicated in the table.

For oil plug location, refer to section 1.1.

### Inverted installation lubricating oil capacities:

Actuator Size	Inverted Oil Capacity litres (pt.-US)	Top-up quantity litres (pt.-US)
IQ10, 12, 18	1.25 (2.64)	0.0 (0.0)
IQ19, 20, 25	1.90 (4.0)*	0.0 (0.0)
IQ35	2.75 (5.81)	0.35 (0.74)
IQ40, 70, 90, 91, 95	5.7 (12.04)	2.0 (4.23)

## **IQ Cover tubes**

Cover tubes not supplied by Rotork shall be designed to ensure that they do not exceed BOTH mass and moment parameters listed in the table below.

They shall also be of a suitable material for the application and be suitably finished and protected for the environmental conditions.

If cover tubes exceed these parameters (due to weight, length, wind, etc.) they must be properly supported.

<b>Frame size</b>	<b>Maximum mass (kg)</b>	<b>Maximum mass (lbs)</b>	<b>Maximum moment* (Nm)</b>	<b>Maximum moment* (lbf.ft)</b>
IQ10 – IQ18	5	11	305	225
IQ19 – IQ25	11	24.3	690	509
IQ35	17	37.5	955	704
IQ40 – IQ95	17	37.5	955	704

\*Moment measured about centre of cover tube bolt mounting PCD.

## **12. IQ Approvals**

Refer to actuator nameplate for unit specific approval details.

### **European – Hazardous Area**

**ATEX (2014/34/EU) II 2 GD c**

**Ex d IIB T4 Gb**

**Ex tb IIIC T120°C Db, IP66 & IP68**

Temperature -20°C to +70°C (-4°F to +158°F)

\*Option -30°C to +70°C (-22°F to +158°F)

\*Option -40°C to +70°C (-40°F to +158°F)

\*Option -50°C to +40°C (-58°F to +104°F)

**Ex d IIC T4 Gb**

**Ex tb IIIC T120°C Db, IP66 & IP68**

Temperature -20°C to +70°C (-4°F to +158°F)

\*Option -30°C to +70°C (-22°F to +158°F)

\*Option -40°C to +70°C (-40°F to +158°F)

\*Option -50°C to +40°C (-58°F to +104°F)

**Ex de IIB T4 Gb**

**Ex tb IIIC T120°C Db, IP66 & IP68**

Temperature -20 to +70°C (-4°F to +158°F)

\*Option -30°C to +70°C (-22°F to +158°F)

\*Option -40°C to +70°C (-40°F to +158°F)

\*Option -50°C to +40°C (-58°F to +104°F)

**Ex de IIC T4 Gb**

**Ex tb IIIC T120°C Db, IP66 & IP68**

Temperature -20°C to +70°C (-4°F to +158°F)

\*Option -30°C to +70°C (-22°F to +158°F)

\*Option -40°C to +70°C (-40°F to +158°F)

\*Option -50°C to +40°C (-58°F to +104°F)



## International – Hazardous Area

### **IECEx. IEC60079-0 & IEC600679-1**

#### **Ex d IIB T4 Gb**

#### **Ex tb IIIC T120°C Db, IP66 & IP68**

Temperature -20°C to +70°C (-4°F to +158°F)

\*Option -30°C to +70°C (-22°F to +158°F)

\*Option -40°C to +70°C (-40°F to +158°F)

\*Option -50°C to +40°C (-58°F to +104°F)

#### **Ex d IIC T4 Gb**

#### **Ex tb IIIC T120°C Db, IP66 & IP68**

Temperature -20°C to +70°C (-4°F to +158°F)

\*Option -30°C to +70°C (-22°F to +158°F)

\*Option -40°C to +70°C (-40°F to +158°F)

\*Option -50°C to +70°C (-58°F to +158°F)

#### **Ex de IIB T4 Gb**

#### **Ex tb IIIC T120°C Db, IP66 & IP68**

Temperature -20°C to +70°C (-4°F to +158°F)

\*Option -30°C to +70°C (-22°F to +158°F)

\*Option -40°C to +70°C (-40°F to +158°F)

\*Option -50°C to +70°C (-58°F to +158°F)

#### **Ex de IIB T4 Gb**

#### **Ex tb IIIC T120°C Db, IP66 & IP68**

Temperature -20°C to +70°C (-4°F to +158°F)

\*Option -30°C to +70°C (-22°F to +158°F)

\*Option -40°C to +70°C (-40°F to +158°F)

\*Option -50°C to +70°C (-58°F to +158°F)

## USA – Hazardous Area

FM - Explosionproof to NEC Article 500.

#### **Class I, Division 1, Groups C & D**

#### **Class II, Division 1, Groups E, F & G**

Temperature -30°C to +70°C (-22°F to +158°F)

\*Option -40°C to +70°C (-40°F to +158°F)

\*Option -50°C to +40°C (-58°F to +104°F).

#### **Class I, Division 1, Groups B, C & D**

#### **Class II, Division 1, Groups E, F & G**

Temperature -30°C to +70°C (-22°F to +158°F)

\*Option -40°C to +70°C (-40°F to +158°F)

\*Option -50°C to +40°C (-58°F to +104°F).

## Canada – Hazardous Area

CSA Explosionproof to C22.2 No 30

#### **Class I, Division 1, Groups C & D**

#### **Class II, Division 1, Groups E, F & G**

Temperature -30°C to +70°C (-22°F to +158°F)

\*Option -40°C to +70°C (-40°F to +158°F)

\*Option -50°C to +40°C (-58°F to +104°F).

#### **Class I, Division 1, Groups B, C & D**

#### **Class II, Division 1, Groups E, F & G**

Temperature -30°C to +70°C (-22°F to +158°F)

\*Option -40°C to +70°C (-40°F to +158°F)

\*Option -50°C to +40°C (-58°F to +104°F).

## International Non Hazardous

### **Watertight, BS EN60529**

#### **IP66 & IP68, (20 metres for 10 days).**

Temperature -30°C to +70°C (-22°F to +158°F)

\*Option -40°C to +70°C (-40°F to +158°F)

\*Option -50°C to +40°C (-58°F to +104°F)

## US – Non Hazardous

### **NEMA Enclosure Type 4 & 6**

Temperature -30°C to +70°C (-22°F to +158°F).

\*Option -40°C to +70°C (-40°F to +158°F)

\*Option -50°C to +40°C (-58°F to +104°F).

## Canada – Non Hazardous

### **NEMA Enclosure Type 4 & 6**

Temperature -30°C to +70°C (-22°F to +158°F)

\*Option -40°C to +70°C (-40°F to +158°F).

\*Option -50°C to +40°C (-58°F to +104°F).

Rotork can supply actuators to national standards not listed above. For details please contact Rotork.

### 13. Approved Fuses

---

FS1 = Bussman TDC11 (rating as per transformer type. See actuator wiring diagram for transformer type).

Type 1 = 250 mA anti-surge

Type 2 = 250 mA anti-surge

Type 3 = 150 mA anti-surge

FS2 (ATEX units only)

Bussman TDS 500 - 100 mA Quickblow  
or Littell Fuse 217 - 100 mA Quickblow

### 14. Vibration, Shock and Noise

---

Standard IQ range actuators are suitable for applications where vibration and shock severity does not exceed the following:

Type	Level
Plant induced vibration	1g rms total for all vibration within the frequency range of 10 to 1000 Hz
Shock	5g peak acceleration
Seismic	2g acceleration over a frequency range of 1 to 50 Hz if it is to operate during and after the event
Emitted noise	Independent tests have shown that at 1m generated noise does not exceed 65 db(A)

### 15. Conditions of Safe Use

---

#### EMC

The equipment is intended for use in an industrial electromagnetic environment.

#### 15.1 Thread details for ATEX and IECEx Approved actuators

---

Threaded Flamepath	Thread Size	Thread Length	Actuator Type and Size
Battery Cover	M40x1.5	10.00	All Types and Sizes
Cable Entry	M25x1.5	20.00	All Types and Sizes
	M40x1.5	20.00	All Types and Sizes

## 15.2 Maximum constructional flamepath gaps for ATEX and IECEx Approved actuators.

Flamepath	Max. Gap (mm)	Min. Length (mm)	Actuator Type and Size
Motor Cover / Gearcase	0.15	25.00	IQ10, IQ12, IQ18, IQ19, IQ20, IQ25, IQ35, IQM10, IQM12, IQM20, IQM25, IQS12, IQS20, IQS35, IQ40, IQ70, IQ90, IQ91, IQ95
Wormshaft Shroud / Gearcase	0.05	35.00	IQ10, IQ12, IQ18, IQM10, IQM12, IQS12
		38.00	IQ19, IQ20, IQ25, IQM20, IQM25, IQS20
		35.00	IQ35, IQS35
Wormshaft Shroud / Gearcase	-0.04/0.00	49.75	IQ40, IQ70, IQ90, IQ91, IQ95
Wormshaft / Wormshaft Shroud	0.24	26.00	IQ10, IQ12, IQ18, IQM10, IQM12, IQS12
		26.00	IQ19, IQ20, IQ25, IQM20, IQM25, IQS20
		27.00	IQ35, IQS35
Wormshaft / Wormshaft Shroud	0.25	49.75	IQ40, IQ70, IQ90, IQ91, IQ95
Terminal Bung Gearcase (IIB)	0.20	27.00	All Types and Sizes
Terminal Bung Gearcase (IIC)	0.115	27.00	All Types and Sizes
Terminal Cover / Gearcase	0.15	27.00	All Types and Sizes
Electrical Cover / Gearcase	0.15	26.00	All Types and Sizes
Encoder Shaft / Encoder Shaft Bush	0.08	27.00	All Types and Sizes
Encoder Shaft Bush / Gearcase	0.07	25.00	All Types and Sizes
Motor Loom Bush / Gearcase	0.15	28.75	IQ10, IQ12, IQ18, IQ19, IQ20, IQ25, IQ35, IQM10, IQM12, IQM20, IQM25, IQS12, IQS20, IQS35
		33.25	IQ40, IQ70, IQ90, IQ91, IQ95
DC Motor Adaptor / Gearcase	0.15	25.00	IQD10, IQD12, IQD18, IQD20, IQD25
DC Motor Cover / DC Motor Cover Adaptor	0.15	12.50	IQD10, IQD12, IQD18, IQD20, IQD25

**Note:** Negative sign denotes an interference fit.



Keeping the World Flowing

---

*UK*

Rotork plc

*tel* +44 (0)1225 733200

*fax* +44 (0)1225 333467

*email* mail@rotork.com

*USA*

Rotork Controls Inc.

*tel* +1 (585) 247 2304

*fax* +1 (585) 247 2308

*email* info@rotork.com

A full listing of our worldwide sales and service network is available on our website.

**[www.rotork.com](http://www.rotork.com)**

---

**Original instructions: English language version only.** As part of a process of on-going product development, Rotork reserves the right to amend and change specifications without prior notice. Published data may be subject to change. For the very latest version release, visit our website at [www.rotork.com](http://www.rotork.com)

The name Rotork is a registered trademark. Rotork recognises all registered trademarks. The Bluetooth® word mark and logos are registered trademarks owned by Bluetooth SIG, Inc. and any use of such marks by Rotork is under license. Published and produced in the UK by Rotork. POWJB0519

**PUB002-039-00**  
**Date of issue 07/19**

---