

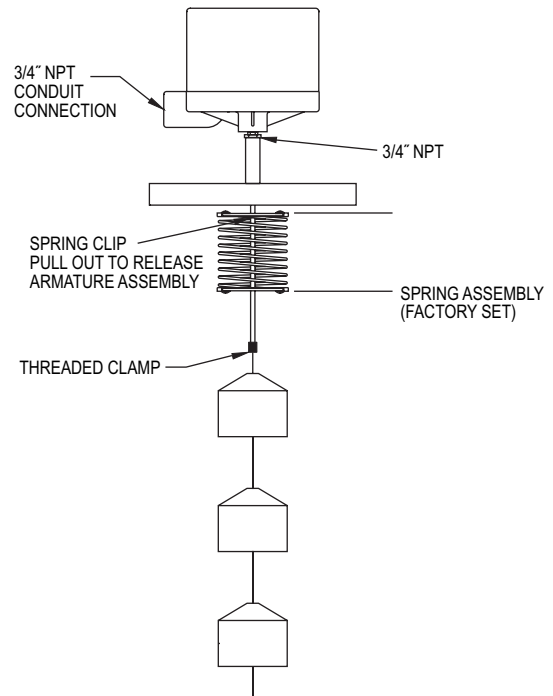

Series 190 Displacer Type Liquid Level Controls

Specifications - Installation and Operating Instructions



OPERATING CHARACTERISTICS

The displacers are suspended on a cable from the armature of a magnetic head control with a spring partially supporting their weight. As the displacers become submerged in a rising liquid, their weight decreases, allowing the spring to move the cable and armature upward, thereby actuating the mercury switches or snap action switches.

The displacers are secured on the cable by clamps. Operating levels can be adjusted by loosening the clamps and moving the displacers up or down the cable as required. The buoyancy produced by the submerging of one displacer is not sufficient to allow the spring to raise the armature*; a second displacer must be partially submerged before any operation occurs on a rise. On a drop, however, the cable will not move to its full down position until the level falls to approximately the mid point of the lowest displacer. By spacing the displacers and calibrating the spring, adjustable level operation and various stage operations can be provided.

*Exception - Typer 195-4: Lower stage operates on and off as liquid level move within length of lower displacer.

Typer A-190 operates on and off as liquid level moves within length of a single displacer.

Construction - all types. Standard displacers are porcelain (also available of other materials). Stops 316SS. Cable (10 ft) 316 stainless steel (longer lengths available). All enclosures equipped with 3/4" NPT conduit connection. Terminal block for electrical connections. Stand flange: 4" 125# C1 - other sizes and materials available.

INSTALLATION INSTRUCTIONS

MOUNTING

All types must be mounted with switch mechanism in a level position. Flange must be positioned so that control is mounted level.

Check for obstructions in tank or vessel - be sure that no rods, projections or other obstacles interfere with free operations of the displacers.

No guides are necessary unless excessive turbulence occurs, in which case, a guide pipe could be used. The inner diameter of the pipe or tube should be at least one half to one inch larger than the diameter of the displacers and should have a vent above the high level of the liquid - bottom end to be open.

PROCEDURE FOR INSTALLING CONTROL HEAD AND DISPLACERS

Note: Do not tamper with setting of spring assembly. It has been factory set for the specific gravity specified on your order.

Disassemble equipment as follows:

- Remove spring clip located near bottom end of the threaded connection protruding from control case. Pull out on spring clip which releases armature rod, and spring assembly.
- Insert control head thru flange and tighten securely by means of the treaded connection. Use a wrench only on the hex surface under control base.
- Reassemble armature rod with spring assembly into bottom opening of the threaded pipe connection and secure with spring clip. **Note:** On two stage models be sure washer is inside tube before inserting spring clip. To facilitate insertion of washer and spring clip turn control upside down on a firm surface.
- Attach cable and displacers to armature by means of the threaded clamp attached to the cable.
- Insert complete assembly and flange into the tank or vessel and fasten flange.

WIRING

Wire in accordance with local electrical codes or follow equipment manufacturers instructions.

CAUTION: Do not loosen or move switch mechanisms or control adjustment will be altered. Do not tamper with switch wires. Position of these wires is essential to proper operation. Tampering with these wires will void warranty.

SINGLE STAGE OPERATION

Single stage controls will operate at any specific gravity and temperature listed in tables with standard factory setting.

Series A190 - Single Stage - Fixed Differentials

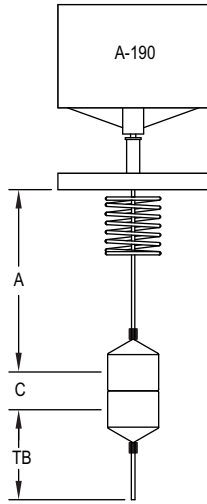

Series A190 - Single Stage - Fixed Differentials									
SP	100°F				200°F				
GR	A		C	Min. TB	A	C		C	Min. TB
	Max.	Min.				Max.	Min.		
0.5	121.5 [3086]	7-1/2 [190]	1-1/2 [38]	2-3/4 [70]	121 [3073]	7 [178]	1-3/4 [44]	3-1/4 [83]	
0.6	122 [3100]	8 [203]	1-1/4 [32]	2-1/2 [64]	121 [3073]	7-1/2 [190]	1-1/2 [38]	2-7/8 [73]	
0.7	122 [3100]	8-1/2 [216]	1-1/8 [29]	2-3/8 [60]	122 [3100]	8 [203]	1-1/4 [32]	2-3/4 [70]	
0.8	122.5 [3111]	9 [229]	1 [25]	2-1/4 [57]	122 [3100]	8 [203]	1-1/8 [29]	2-1/2 [64]	
0.9	123 [3124]	9 [229]	7/8 [22]	2-1/8 [54]	122 [3100]	8-1/2 [216]	1 [25]	2-3/8 [60]	
1.0	123 [3124]	9 [229]	3/4 [19]	2 [51]	122.5 [3111]	8-1/2 [216]	7/8 [22]	2-1/4 [57]	
1.1	123 [3124]	9 [229]	5/8 [16]	2 [51]	122.5 [3111]	8-1/2 [216]	3/4 [19]	2-1/8 [54]	
1.2	123 [3124]	9-1/2 [241]	3/8 [16]	1-7/8 [48]	122.5 [3111]	8-1/2 [216]	3/4 [19]	2-1/8 [54]	

Series B190 - Single Stage - Adjustable Differentials

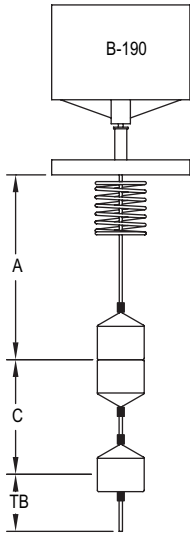

Series B190 - Single Stage - Adjustable Differentials										
SP	100°F				TB Min.	200°F				
GR	A		C			A	C		C	
	Max	Min	Max	Min	Max		Min	Max	Min	
0.6	116-1/2 [2959]	6-1/2 [165]	114 [2896]	6-3/4 [171]	2-1/2 [64]	-	-	-	-	-
0.7	117 [2972]	7-1/2 [191]	115-1/2 [2934]	6 [152]	2-3/8 [60]	-	-	-	-	-
0.8	118 [2997]	8 [203]	115 [2921]	5-1/2 [140]	2-1/4 [57]	118 [2997]	8 [203]	115 [2921]	4-3/4 [121]	3 [76]
0.9	118-1/2 [3010]	8-1/2 [216]	115 [2921]	5 [127]	2-1/8 [54]	118-1/2 [3010]	8-1/2 [216]	114-1/2 [2908]	4-3/8 [111]	2-7/8 [73]
1.0	119 [3023]	9 [229]	114-1/2 [2908]	4-5/8 [117]	2 [51]	119 [3023]	8-1/2 [216]	114-1/2 [2908]	4-1/8 [105]	2-5/8 [67]
1.1	119 [3023]	9-1/2 [241]	114-1/2 [2908]	4-3/8 [111]	1-7/8 [48]	119 [3023]	9 [229]	114 [2896]	3-7/8 [98]	2-1/2 [64]
1.2	120 [3048]	9-1/2 [241]	114-1/2 [2908]	4 [102]	1-3/4 [44]	119-1/2 [3035]	9 [229]	114 [2896]	3-3/4 [95]	2-3/8 [60]

Minimum differential (c) can be reduced, approximately 1" by removing the cable clamp from between the displacers and turning the lower displacer so the flat side is up. If a narrower differential is needed, use a Type A190 control.

SINGLE STAGE CIRCUIT SPECIFICATIONS AND ELEC. RATING

MERCURY SWITCH TYPES

AC or DC
 10 amp. 120 volts, 5 amp. 240 volts
 Available 440 volts 3 amp. A.C.

Circuit Arrangement	Circuit Response to Liquid Level Changes	Spec NO.
SP-ST	Close on level DROP	No. 4820
SP-ST	Close on level RISE	No. 4821
SP-DT	One circuit CLOSES other circuit OPENS	No. 4815
DP-ST	Close on level DROP	No. 4814
DP-ST	Close on level RISE	No. 4813

ENCLOSED METAL CONTACT SNAP-ACTION SWITCHES

12 Amp. 120 volts; 5 Amp. 240 volts AC.
 1/2 hp. 120/240 volts AC
 D.C. 0.5 Amp. 125 volts; 0.25 Amp. 250 volts

CIRCUITS

SINGLE STAGE

Spec. No. 7810 (1) SP-DT Switch
 Spec. No. 7806 (2) SP-DT Switches

TWO STAGE OPERATION

All two stage types are factory set for a given specific gravity and temperature for each application.

Series 195-4 - Two Stage - Fixed Differentials Adjustable Spread Between Stages

Minimum Specific Gravity 0-9 - Maximum Temperature 200°

On specific gravities below .95 control is not recommended where temperatures vary appreciably.

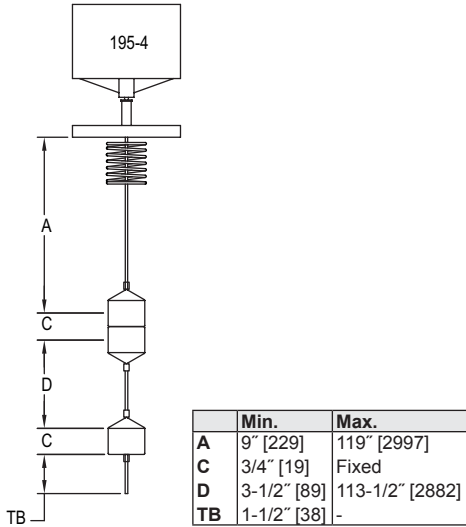

Series 195-6 - Two Stage - Adjustable Differential Each Stage

High trip point for lower stage common with low trip point for upper stage

Minimum Specific Gravity 0.5 - Maximum Temperature 200°

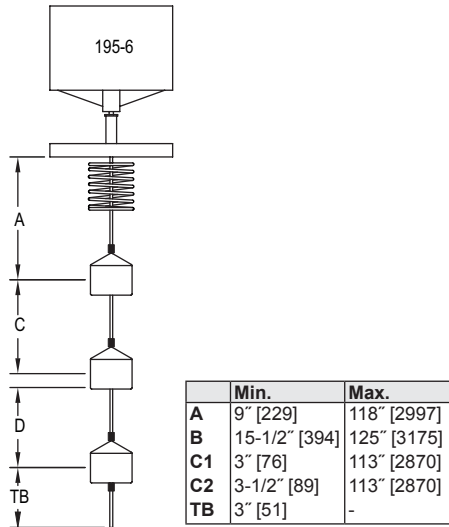

Series 195-7 - Two Stage - Adjustable Differential Each Stage

Common trip point at LOW level

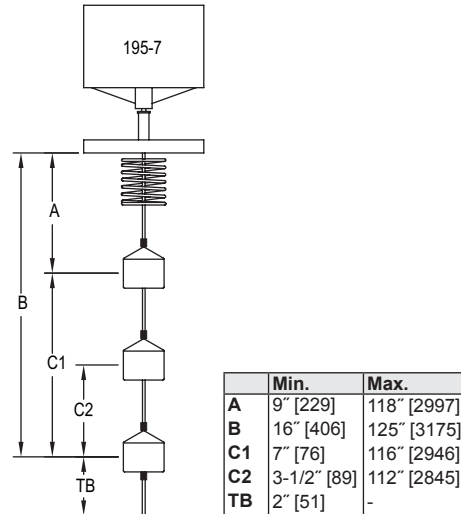

Series 195-8 - Two Stage - Adjustable Differential Each Stage

Common trip point at HIGH level

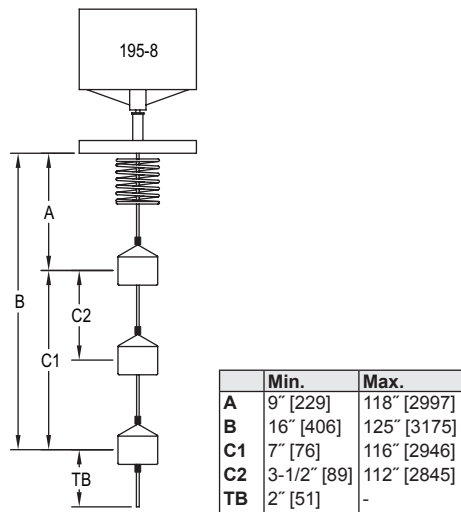

Specific gravity should not vary more than ± 1 from factory setting. Temperature should not vary more than $\pm 50^{\circ}\text{F}$ from factory setting.

Note: Single stage displacer controls will tolerate much wider fluctuations of specific gravity and temperature as indicated in tables.

TWO STAGE CIRCUIT SPECIFICATIONS AND ELEC. RATING

Mercury Switch types

AC or DC

10 Amp. 120 volts

5 Amp. 240 volts

4 Amp. - No. 4810

2 Amp. - No 4810

Circuit Arrangement	Circuit Response to Liquid Level Changes	Lower Stage	Upper Stage
SP-ST	Open on level DROP	No. 4820	-21
SP-ST	Open on level RISE	No. 4821	-26
SP-DT	One circuit OPENS as other circuit CLOSES	No. 4810	-10
SP-DT	One circuit OPENS as other circuit CLOSES	No. 4815	-15
DP-ST	Close on level RISE	No. 4814	-13
DP-ST	Open on level RISE	No. 4813	-14

ENCLOSED METAL CONTACT SNAP-ACTION SWITCHES

12 Amp. 120 volts; 5 Amp. 240 volts AC.

1/2 hp. 120/240 volts AC

D.C. 0.5 Amp. 125 volts; 0.25 Amp. 250 volts

CIRCUITS

Spec. No. 7806 (2 SP-DT each stage)

Spec. No. 7810 (SP-DT each stage)