

WARNING

- This switch is designed for general industrial use, not for use as a safety device.
- Do not connect this device to AC power. Doing so may cause rupture or burnout.

● Handling Precautions

- This device is a precision instrument. Do not hit it or bump it against any object.
- The diameter of the mounting bracket holes must be 4 mm or less. Tighten the mounting screws to a maximum torque of 0.8 N·m.
- Up to 100 ms is required for stabilization after the power is turned on.
- For outdoor use, prevent direct exposure to sunlight and rainwater.
- Do not allow water, cutting oil, etc., to splash on the device or the cables.
- Do not expose the device to chemicals (organic solvents, acids, alkalis).
- If the lens is dirty, wipe it with a soft, damp, clean cloth. Do not use an organic solvent like alcohol.
- Switches cannot be connected in series (AND circuit). Parallel connection (OR circuit) is supported.

● Wiring Precautions

- Bends in the cable should have a radius of at least 15 mm (30 mm min. for the section immediately next to the device).
- Avoid use in which the cable receives repeated bending stress.
- Do not pull the cable with excessive force (≥ 50 N). Doing so might cause disconnection, resulting in a short circuit and burnout.
- Tighten connectors firmly by hand.
- If extension of the cable is necessary, use at least 0.3 mm² wire, no more than 100 m long.
- Special care is required at low temperatures (below 0 °C), because cables become stiff and flexibility is much lower.
- When using an inverter or servo motor, be sure to ground the frame ground terminal and ground terminal.
- Do not put the wires of the photoelectric switch and motor power lines or other power wires in the same conduit. Doing so may cause malfunction or damage due to induction noise. Route the wires separately or put them in a different conduit.

● Installation Precautions

- Install the device so that the target object moves in the direction shown in Fig. 1. If the switch is installed horizontally, false detection of an object that is situated away from the set distance may result. In this case, the use of a shielding plate is recommended. If it is not possible to install a shielding plate, thoroughly check device operation before use.
- If a mirrorlike or reflective object is located near the device, unreliable detection may occur. In this case, increase the distance between the device and the reflective object, or incline the optical axis as shown in Fig. 2.
- Depending on the shape or pattern of the object, unreliable detection may occur. Before use, thoroughly check device operation.
- If the background or the target object is reflective, incline the optical axis so that the device does not receive the reflected light directly.

● Disposal Precautions

- When discarding the product, dispose of it as industrial waste, following local regulations.

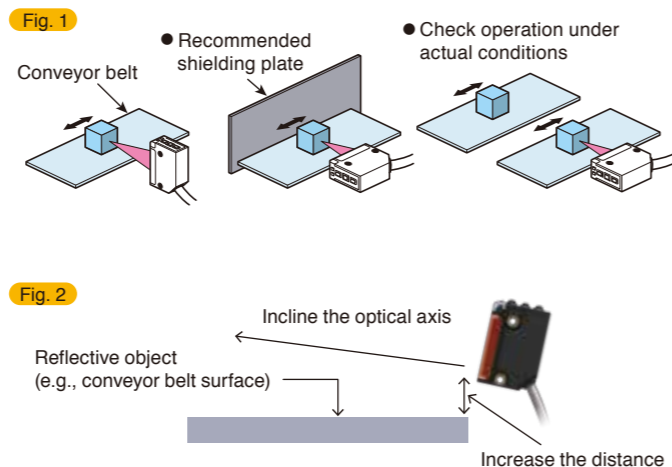

Please read "Terms and Conditions" from the following URL before ordering and use.

<http://www.azbil.com/products/factory/order.html>

Other product names, model numbers and company names may be trademarks of the respective company.

[Notice] Specifications are subject to change without notice.
No part of this publication may be reproduced or duplicated without the prior written permission of Azbil Corporation.

Azbil Corporation

Advanced Automation Company

Yamatake Corporation changed its name to Azbil Corporation on April 1, 2012.

1-12-2 Kawana, Fujisawa
Kanagawa 251-8522 Japan

URL: <http://www.azbil.com>

1st Edition : Feb. 2018-SK
2nd Edition : Mar. 2018-SK

CP-PC-2271E

azbil

Distance-Adjustable Photoelectric Switch

Model HP7-G/HP-F/HP7-S



Performance that exceeds expectations!



Reliable detection of any object under any conditions.

Compact size with super long-distance detection

Thanks to the triangulation method, objects of any color made from any material can be reliably detected. With long-distance detection of up to 750 mm, switch is suitable for use on conveyor lines.

Achieves formerly impossible performance

Compact & super range

3× the distance

Background Suppression type: **750 mm**

Foreground Suppression type: **500 mm**



Designed for ease of use

Regular installation

Industrial standard installation:
mounting hole pitch
of 25.4 mm (1 inch)

25.4 mm (1 inch)

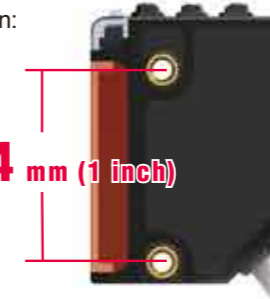

Metal threads

Metal screw threads improve workability by preventing stripping. Higher tightening strength (× 1.6*) prevents cracking of housing. *Compared to our resin threads (0.5 N·m)



Metal threads

Easier to use

Orange indicator
Green indicator

[Far] button (+)

[Center] button (C)

[Near] button (-)

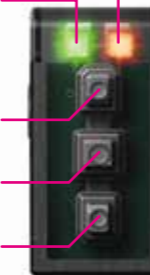

Better display visibility

Models HP7-G□□ / HP7-F□□

Easy and reliable adjustment using the [Center] button for tuning and [Far] and [Near] buttons for adjustment.

Key lock
function



Model HP7-S□□

No adjustment required.



Excellent basic characteristics

Detection performance

The use of triangulation and an infrared light source reduces detection distance variation resulting from differences in object color and material. Capable of detecting small differences.

Temperature characteristics

Variation in sensing distance over full operating temperature range (-30 to +55 °C) is ±4 % max. (reference value when HP7-G81 is set to 500 mm).

Resistance to LED lighting and ambient light

Uses a new algorithm and a filter that cuts light from ambient illumination.

Angle characteristics

Variation in sensing distance in the horizontal direction with a 45° incline: ±2 % max. (reference value when HP7-G81 is set to 500 mm)

LINEUP

Three available models optimized for different purposes

High-performance model HP7-G□□
Background Suppression

- Super-long 750-mm sensing distance
- Ability to tune and adjust allows detection of various types of objects

High-resolution, high-precision model HP7-F□□
Foreground Suppression

- Excellent step difference detection
- Two types, with sensing distances of 500 and 250 mm

Zone detection model HP7-S□□
Background suppression (fixed distance)

- Sensing distance is adjusted at the factory
- Background suppression function is easier to use

Long-distance detection

Reliable detection

Adjustment is not required

Background suppression high-performance model Molde HP7-G□□

Compact, but capable of long-distance detection (to 750 mm). The automatic tuning and adjustment functions allow detection of various types of objects under various installation conditions.

>>> Can reliably detect multiple objects of various colors made from various materials.



Various types of corrugated cardboard cartons
Reliably detects corrugated cardboard cartons of various colors with various types of marking.



Reused pallets
Reliably detects dirty pallets of various colors.

>>> Useful for locations where reflectors cannot be installed.



L-shape conveyors (direction converters and loaders)
The 750-mm sensing distance covers the width of the conveyor belt, simplifying switch layout.



Inspection and carry lines
Reliable detection of the target only, not the worker.

>>> Long-distance models can be located away from the target.

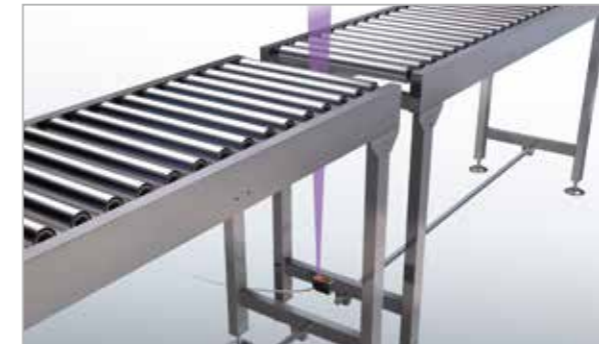

Between conveyor belts
Simplifies switch layout.

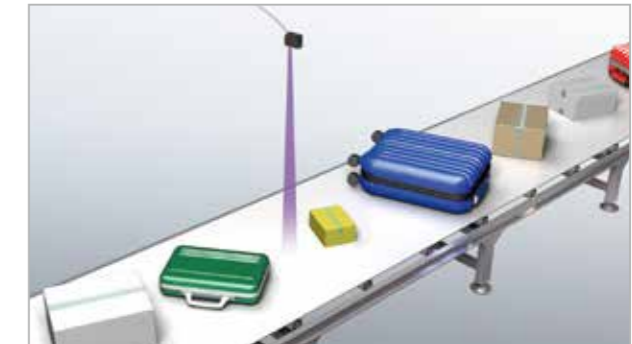

Objects of various heights
Detects objects of various thicknesses.

>>> Approaching objects can be stopped at the desired position.



Can decelerate and stop moving racks
Large sensors are not required. Automatic tuning reduces setup time.

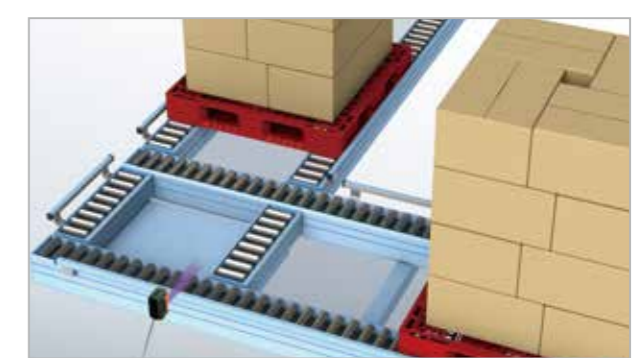

L-shape conveyors (direction converters and loaders)
Since detection does not rely on color or material, it is possible to stop objects at the same position.

Foreground suppression high-resolution, high-precision model Molde HP7-F□□

In addition to detecting small step differences, this model can reliably detect reflective objects.

>>> Detects thin objects

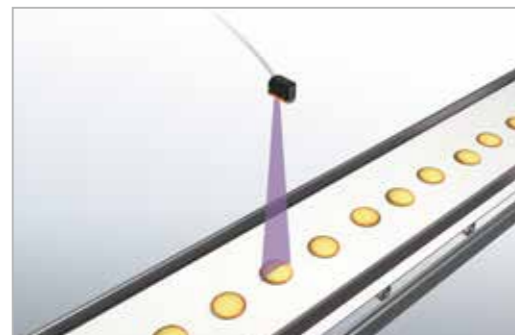

>>> Detects reflective objects

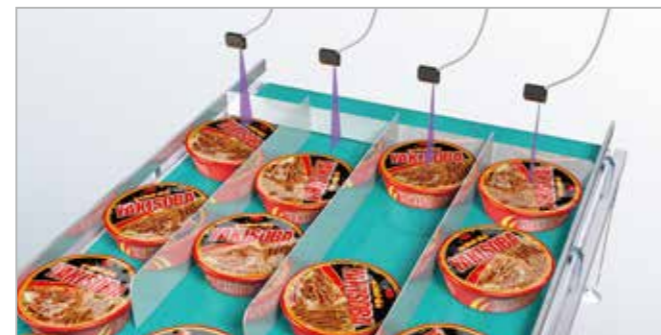

Note: For use only with a stable background (conveyor belt, etc.).

Background suppression (fixed distance) zone detection model Molde HP7-S□□

Background suppression function is easier to use. Sensing distance is adjusted at the factory. Onsite adjustment is not required.

>>> Circuit board transport

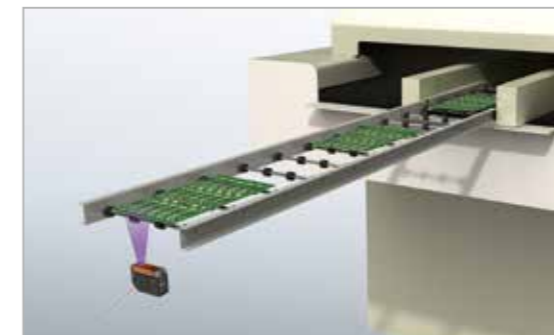

>>> Detection at the bottom layer only of multi-layer conveyor belts

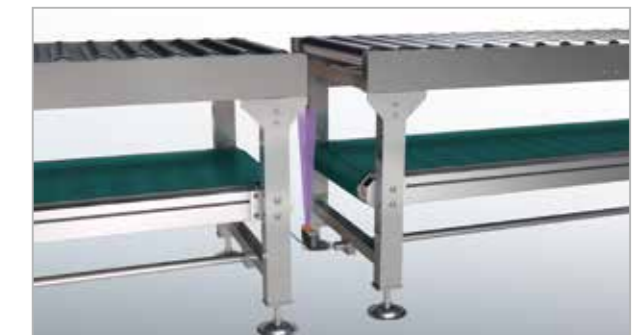

Background Suppression (Normally Open operation)

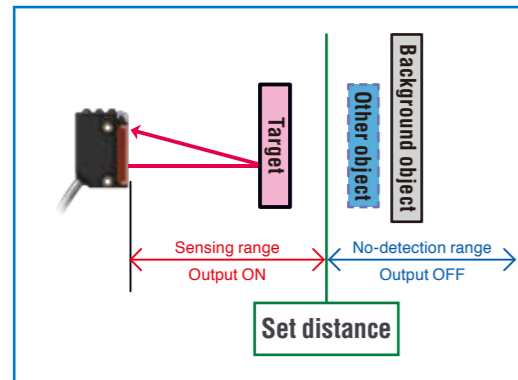

Detection function is based on the distance to the target object.

Background objects beyond the set distance are not detected.

In the figure on the left, the background and other (potentially interfering) object are not detected.

Note

Detection may not be reliable for objects with very low reflectivity or for reflective objects.

Foreground suppression function (Normally Open operation)

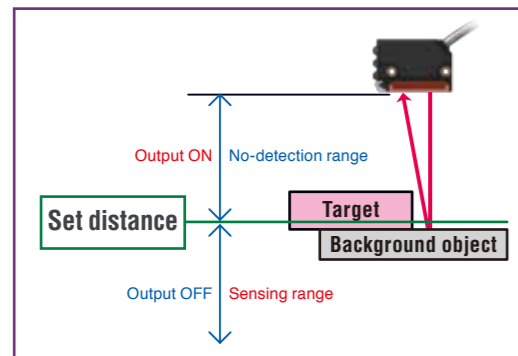

Detection function is based on the distance to the background object.

Effective when there is a conveyor belt or other stable background.

Enables detection of objects that cannot be detected reliably by background suppression (i.e., reflective or low reflectivity objects)

Suitable for detecting small step differences.

Behavior

The switch determines that a target object is present when the background object cannot be detected

Background object is detected = OFF

(1) Object with very low reflectivity

Reflected light is weak, so not received

(2) Other mirror-like object

No diffuse reflection, so no light received

(3) Irregular surface (non-reflective)

Reflected light area is large, so switch correctly judges distance in spite of irregular surface

When no light is received from beyond the set distance, the switch determines that an object is present (ON)

* e.g., conveyor belt

Note Can be used only when there is a background object

Table of models

Type	Appearance	Detection method	Max. sensing distance	Light source	Output	Model No.
Distance-adjustable diffuse scan		Background Suppression	750 mm	Infrared	NPN/NO	HP7-G81
		Foreground Suppression	250 mm		PNP/NO	HP7-G82
		Zone detection background suppression (fixed distance)	500 mm		NPN/NO	HP7-F21
			100 mm		PNP/NO	HP7-F22
			300 mm		NPN/NO	HP7-F41
					PNP/NO	HP7-F42

Item	Appearance	Description	Compatible models	Model No.
Standard bracket		Bottom-mount L-bracket	HP7-G□□ HP7-F□□ HP7-S□□	HP-B80
Wraparound bracket		Wraparound vertical mounting bracket		HP-B81
		Wraparound horizontal mounting bracket		HP-B82

External dimensions

(Unit: mm)

■ HP7-G□□ / HP7-F□□

- Prelead type
- M8 connector type

■ HP7-S□□

- Prelead type
- M8 connector type

■ Brackets

- Bottom-mount L-bracket (HP-B80)

- Wraparound vertical mounting bracket (HP-B81)

- Wraparound horizontal mounting bracket (HP-B82)

Specifications

Type	Distance measurement diffuse scan					
Typical model No.	NPN	HP7-G81	HP7-F21	HP7-F41	HP7-S11 / HP7-S13	HP7-S31 / HP7-S33
	PNP	HP7-G82	HP7-F22	HP7-F42	HP7-S12 / HP7-S14	HP7-S32 / HP7-S34
Detection method	Background Suppression	Foreground Suppression		Zone detection Background Suppression (fixed distance)		
Distance setting method	Tuning: [Center] button. Adjustment: [Far] and [Near] buttons			None		
Power	DC 10.2 to 26.4 V (ripple: 10 % max.)					
Current consumption	20 mA max.					
Distance setting range (target: white paper)	100 to 750 mm	100 to 250 mm	200 to 500 mm	—	—	
Sensing range (target: white paper) *5	From 5 mm to set distance (Set distance: 300 mm min.) From about 32 mm to set distance (Set distance: less than 300 mm)	From 5 mm to set distance (Set distance: 150 mm min.) From about 30 mm to set distance (Set distance: less than 150 mm)	From 5 mm to set distance (Set distance: 300 mm min.) From about 25 mm to set distance (Set distance: less than 300 mm)	Approx. 27 to 100 mm	Approx. 5 to 300 mm	
Hysteresis (target: white paper) *5	When set distance is 750 mm: 8 % max.	When set distance is 250 mm: 0.8 % max.	When set distance is 500 mm: 4 % max.	2 % max.		
Operation modes	N.O. and N.C. can be switched by button operation			HP7-S□1 / HP7-S□2: N.O. operation HP7-S□3 / HP7-S□4: N.C. operation		
Output modes *1	NPN/PNP open collector					
Control output	Switching current: for preleaded and preleaded connector types 100 mA (resistive load), for M8 connector type 50 mA (resistive load) Output withstand voltage: 30 V Residual voltage: 1 V or less					
Response time *2	1 msec		0.7 msec			
Light source	Infrared (wavelength: approx. 860 nm)					
Indicators *3	Operation indicator (orange) Reliability indicator (green)	Operation indicator (orange) Power indicator (green)		Operation indicator (orange) Reliability indicator (green)		
Ambient light intensity	Incandescent light: 10,000 lx max. Sunlight: 40,000 lx max. *4					
Operating temperature	For preleaded and preleaded connector types -30 to +55 °C, for M8 connector type -30 to +50 °C (without freezing or condensation)					
Insulation resistance	20 MΩ min. (at DC 500 V)					
Withstand voltage	AC 1,000 V 50/60 Hz for one minute between electrically live metal and case					
Vibration resistance	10 to 55 Hz, 1.5 mm peak-to-peak amplitude, 2 hours each in X, Y, and Z directions					
Shock resistance	500 m/s ² 10 times each in X, Y, and Z directions					
Protective structure	IP67 (IEC standard)					
Wiring method	HP7-□□□: preleaded 2 m. HP7-□□□-L050: preleaded 5 m. HP7-□□□-C003: M12 preleaded connector, 30 cm. HP7-□□□-T: M8 connector.					
Circuit protection	Error prevention circuit at power on (100 ms max.), power miswiring protection, output short-circuit protection					
Mutual interference protection	Up to 2 units					

*1. FETs are used for output components. *2. Response time may be longer if affected by light from other switches.

*3. For indicator functions see p. 9. *4. HP7-G8□/HP7-F4□: illuminance at lens surface (incidence angle: 15° min.); HP7-F2□/HP7-S1□/HP7-S3□: illuminance of target object

*5. It changes with set distance. Please refer to graph of characteristic (typical example).

Output stage circuit

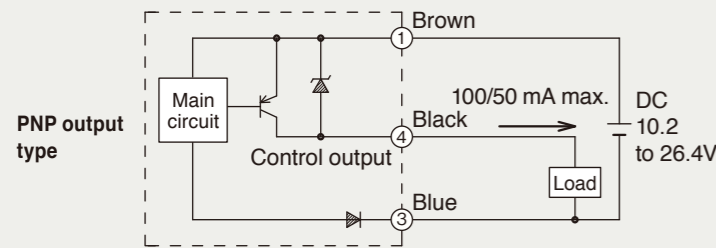
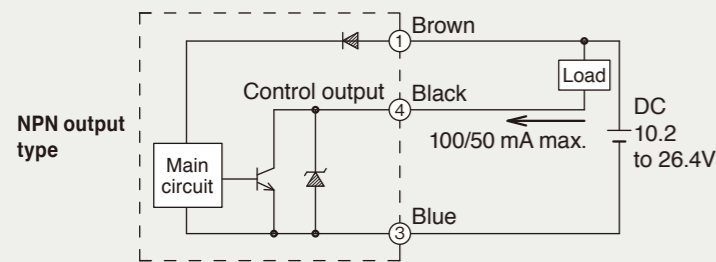

Output operation

Note: The relationship between the presence/absence of an object and the output is the same for both detection methods.

Background Suppression

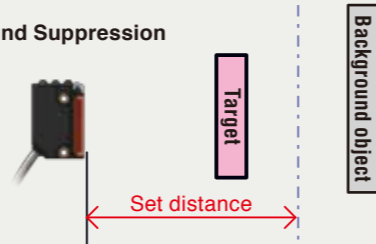

Setting	Target object	Output
N.O.	Yes	ON
	No	OFF
N.C.	Yes	OFF
	No	ON

Foreground Suppression

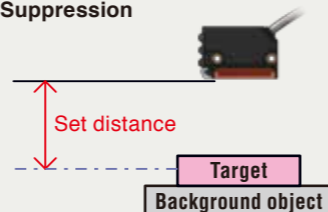

Typical characteristics

Operation range characteristics

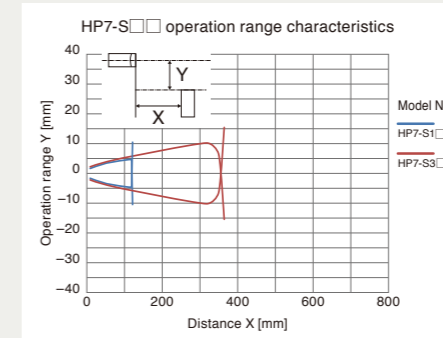
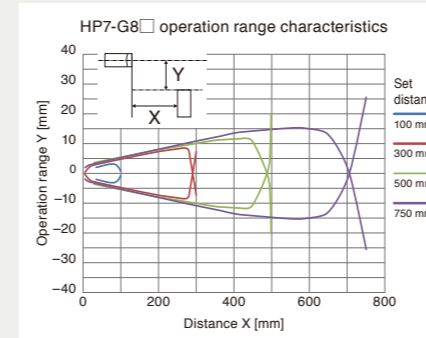

Spot size and distance characteristic

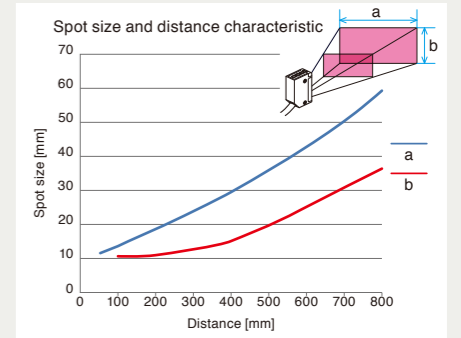

Sensing range

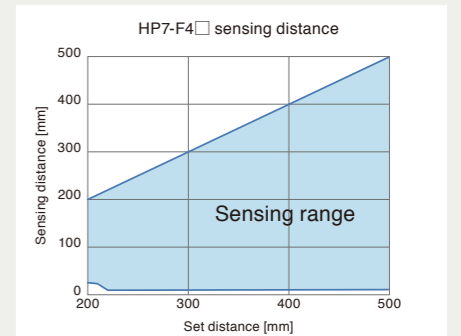
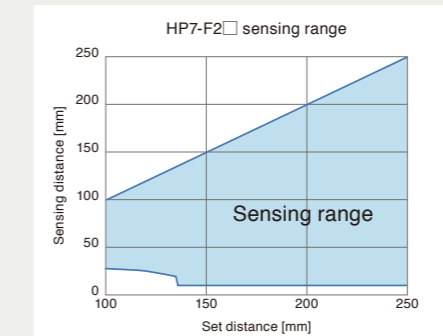
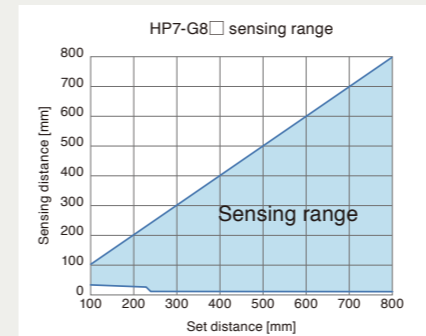

Hysteresis and distance characteristic

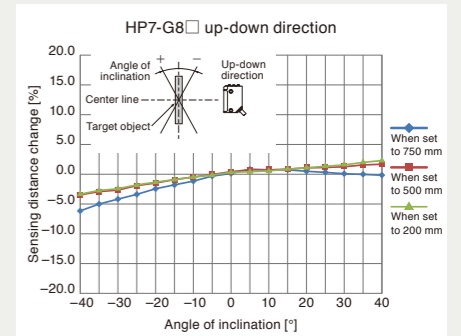
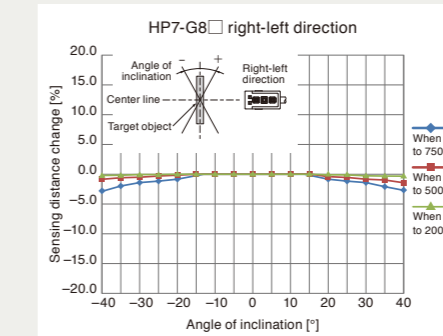
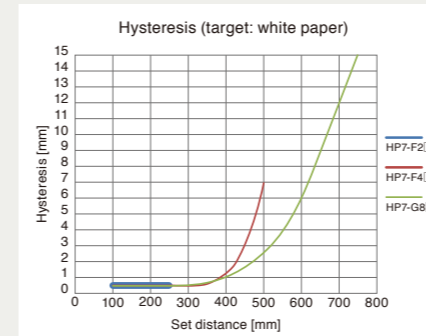

Graphs of sensing distance by object type

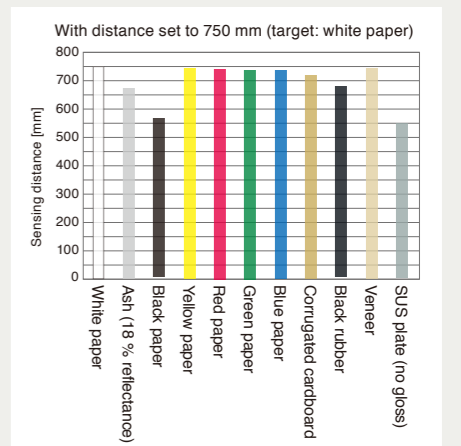
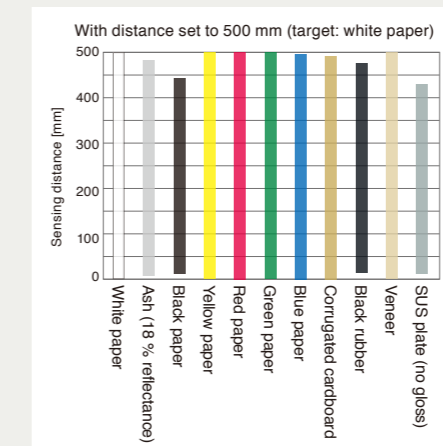
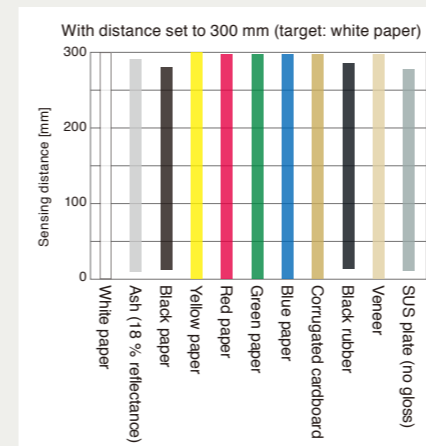

The above characteristics are typical examples only, not guaranteed values. Always test first under actual conditions and allow a margin for error.

Operation procedures (Model HP7-G□□/HP7-F□□)

Names of parts

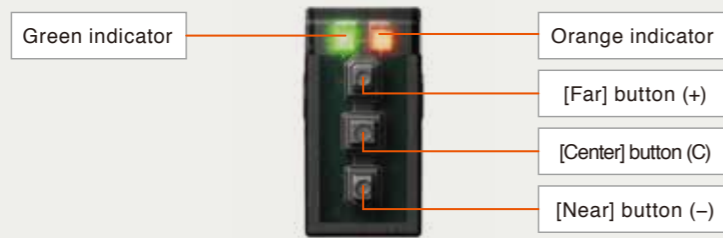

Indicator status

Indicator	During normal operation		During tuning
	HP7-G□□	HP7-F□□	
Green indicator	Lit when detection is reliable	Always on	Blinks to indicate guidance
Orange indicator	Lit when output is ON		

Operation process flow: Relevant operation procedures

- STEP 1** Disable key lock
- STEP 2** Adjust optical axis, tune device
- STEP 3** Adjust set distance

Operation procedures Note: The key lock is enabled when the device is turned on.

STEP 1 Disabling and setting the key lock

Disabling the key lock

Turn the key lock off.

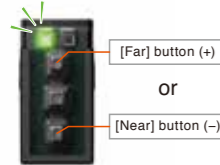

Hold down the [Far] or [Near] button until the green LED starts to blink slowly (approx. 3 seconds).

The green LED blinks slowly (at approx. 1 Hz) when keys are unlocked.

Enabling the key lock

To enable the key lock, turn the power off and back on, or do the following.

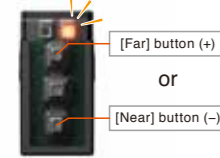

Hold down the [Far] or [Near] button until the orange LED starts to blink slowly (approx. 3 seconds).

The orange LED blinks slowly (at approx. 1 Hz) when the keys are locked.

Checking the N.O./N.C. setting

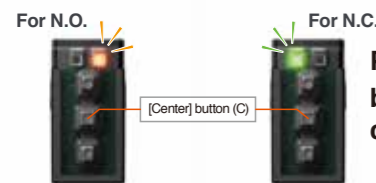

Press [Center] button **3 times** consecutively

Orange LED blinks rapidly (at approx. 10 Hz) Green LED blinks rapidly (at approx. 10 Hz)

Switching between N.O. and N.C.

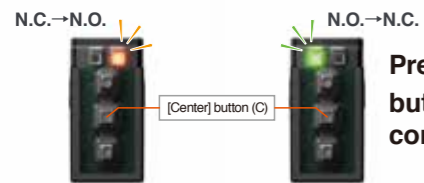

Press [Center] button **5 times** consecutively

Orange LED blinks rapidly (at approx. 10 Hz) Green LED blinks rapidly (at approx. 10 Hz)

Restoring default settings

Factory default settings for set distance and N.O./N.C. can be restored.

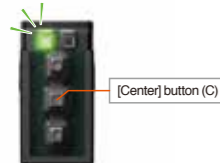

Hold down the [Center] button until the green LED starts to blink rapidly (approx. 5 seconds) (at approx. 10 Hz).

Green LED blinks rapidly (at approx. 10 Hz)

STEP 2 Tuning (Model HP7-G□□)

After adjusting the optical axis, tune the device. The set distance (OP) is automatically adjusted based on the state of the target object and background. If desired, change the set distance by doing **STEP 3**.

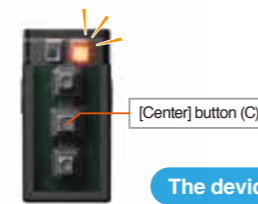

Hold down the [Center] button (for approx. 1 second) until the orange LED starts to blink, and then release.

Orange LED blinks rapidly (at approx. 10 Hz)

The device goes into tuning mode

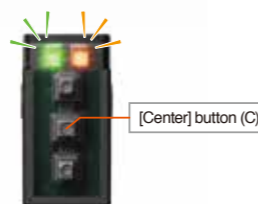

With no target object present, quickly press and release the [Center] button.

The orange and green LEDs blink rapidly (at approx. 10 Hz).

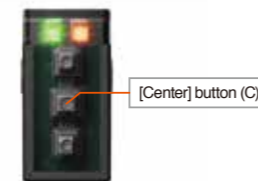

With a target object in position, quickly press and release the [Center] button.

Blinking stops and normal operation begins.

Setup is complete

STEP 2 Tuning (Model HP7-F□□)

After adjusting the optical axis, tune the device. The set distance (OP) is automatically adjusted based on the distance to the background. The set distance after tuning varies depending on the distance to the background. It is set slightly in front of the background (by 2 to 15 mm). If desired, change the set distance by doing **STEP 3**.

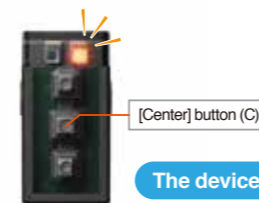

Orange LED blinks rapidly (at approx. 10 Hz)

The device goes into tuning mode

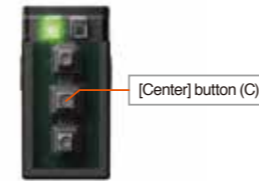

With no target object present, quickly press and release the [Center] button.

Blinking stops and normal operation begins.

Setup is complete

Output operation (N.O./N.C.)

The relationship between N.O./N.C. setting and output operation is shown below.

- With a target object
- Without target object

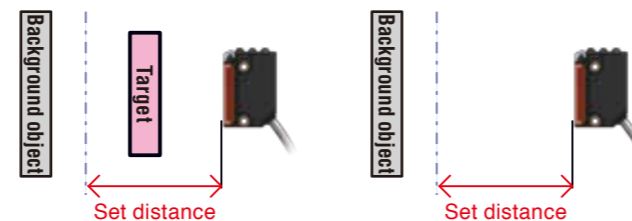

Setting	Target object	Output
N.O.	Yes	ON
	No	OFF
N.C.	Yes	OFF
	No	ON

STEP 3 Adjustment

After tuning the device in **STEP 2**, adjust the set distance if desired. After adjustment and before use, check device operation by executing trial runs.

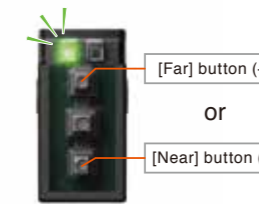

Quickly press and release the [Far] or [Near] button to start adjustment.

Helpful Hint
Do not press and hold the button down. Doing so will lock the keys.

Green LED blinks rapidly (at approx. 10 Hz)

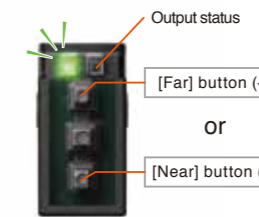

Press the [Far] button to set a longer distance and the [Near] button to set a shorter one.

Far Near

Green LED blinks rapidly (at approx. 10 Hz)
Orange LED indicates output status



Quickly press and release the [Center] button.

Blinking stops and normal operation begins.

Setup is complete

Amount of change when [Far] or [Near] button is pressed once		
Sensing distance	Background Suppression	Foreground Suppression
250 mm	Approx. 2.5 mm	Approx. 0.5 mm
500 mm	Approx. 5 mm	Approx. 1.5 mm
750 mm	Approx. 15 mm	