

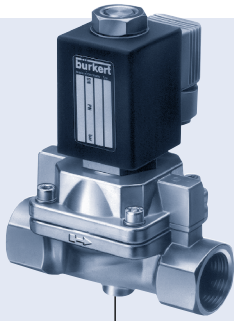



## 2/2-way Solenoid Valve for neutral media up to 356°F (+180°C)



Type 0407 can be combined with...

- Servo-piston with forced lift
- Switches without differential pressure
- Temperatures up to 356°F (+180°C)
- For neutral media, incl. steam
- Push-over coil system
- Approvals:    

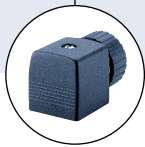

**Type 2508**  
Cable plug



**Type 1078**  
Timer unit



**Type 2511**  
ASI cable plug



**Type 8600**  
Dosing control

The Type 0407 is a pilot controlled solenoid valve with servo-piston and forced valve lift. It is suitable for media temperatures up to 356°F (+180°C). The valve opens without differential pressure from zero bar, and is closed by its own medium and spring force when power is removed!

Orifice	Electrical Power Consumption		
	Inrush	Hold	
DN [mm]	AC [VA]	AC [VA/W]	DC [W]
13 – 40	100	35/14	–
50	–	–/12	30

Technical data	
<b>Orifice</b>	1/2" – 2" (DN 13 – 50 mm)
<b>Body material</b>	Brass
<b>Seal material</b>	PTFE/Graphite
<b>Media</b>	Neutral media such as hot water and steam
<b>Media temperature</b>	–40°F to 356°F (–40°C to +180°C)
<b>Ambient temperature</b>	Max. –40°F to 131°F (–40°C to +55°C)
<b>Viscosity</b>	Max. 21 cSt
<b>Voltage tolerance</b>	±10%
<b>Duty cycle</b>	100% continuous rating
<b>Electrical connection</b>	Cable plug for Ø 7 mm cable (supplied as standard)
<b>Protection class</b>	IP 65 with cable plug
<b>Installation</b>	As required, preferably with actuator upright

Dimensions

Dimensions [mm]								
DN	D	B	E	F	G	H	J	L
13	NPT 1/2	127	40	14	-	40	73.0	65
20	NPT 3/4	147	60	16	-	49	80.5	100
25	NPT 1	157	70	18	-	49	80.5	115
32	NPT 1 1/4	186	85	20	-	49	80.5	126
40	NPT 1 1/2	195	85	22	-	49	80.5	126
50	NPT 2	260	115	24	-	72	104.5	164

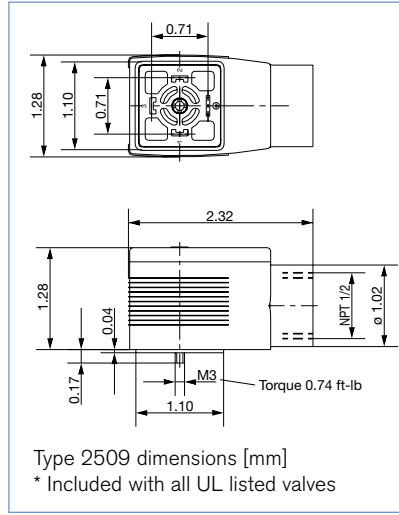
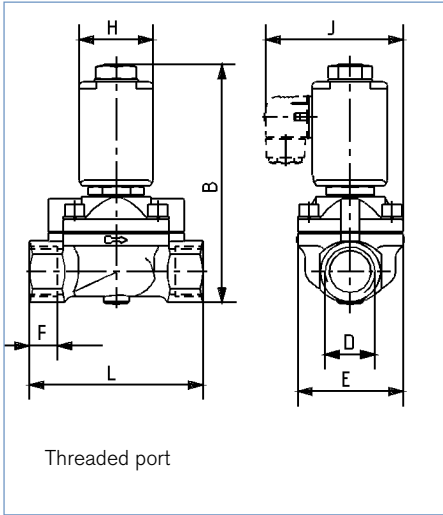

DTS 1000082401 EN Version: A Status: RL (released | freigegeben | validé) printed: 22.09.2017

Ordering chart for valves (other versions on request)

All valves with cable plug, seal material PTFE/graphite

Circuit function	Orifice [mm]	Port connection [NPT]	C <sub>v</sub> value water [GPM]	Pressure range [PSI]	Body material	Voltage/frequency [V/Hz]	Item no.	Item no. UL listed
	13	NPT 1/2	4.3	0 - 145	Brass	24/60	450354	453046
						120/60	450355	453045
						240/60	450356	US01471
	20	NPT 3/4	5.8	0 - 145	Brass	24/60	450357	453048
						120/60	450358	453047
						240/60	454436	US00650
	25	NPT 1	11.7	0 - 145	Brass	24/60	453874	453050
						120/60	450361	453049
						240/60	450362	453194
	32	NPT 1 1/4	18.8	0 - 145	Brass	24/60	US01391	460261
						120/60	453902	-
						240/60	-	-
	40	NPT 1 1/2	18.8	0 - 145	Brass	24/60	US00563	-
						120/60	453903	-
240/60						456476	-	
50	NPT 2	42.3	0 - 145	Brass	120/UC	454357	-	
					240/UC	456289	-	

For UC (Universal Current), the cable plug has an integrated single-phase bridge, rectifier.

In case of special application conditions, please consult for advice.

We reserve the right to make technical changes without notice.

1409/2\_US-en