

Battery-Powered MCF Air Flowmeter User's Manual

**for
Installation and Configuration**



Thank you for purchasing the MCF.

This manual contains information for ensuring the correct use of the MCF. It also provides necessary information for installation, maintenance, and troubleshooting.

This manual should be read by those who design and maintain equipment that uses the MCF. Be sure to keep this manual nearby for handy reference.

Azbil Corporation

NOTICE

Be sure that the user receives this manual before the product is used.

Copying or duplicating this user's manual in part or in whole is forbidden. The information and specifications in this manual are subject to change without notice.

Considerable effort has been made to ensure that this manual is free from inaccuracies and omissions. If you should find an error or omission, please contact Azbil Corporation.

In no event is Azbil Corporation liable to anyone for any indirect, special or consequential damages as a result of using this product.

© 2010-2012 Azbil Corporation All Rights Reserved.

The μ F™, Micro Flow and μ F sensor are a trademarks of Azbil Corporation in Japan.

Conventions Used in This Manual

- To prevent injury to the operator and others, and to prevent property damage, the following types of safety precautions are indicated:



Warnings are indicated when mishandling this product might result in death or serious injury.



Cautions are indicated when mishandling this product might result in minor injury to the user, or only physical damage to the product.

- In describing the product, this manual uses the icons and conventions listed below.



Use caution when handling the product.



The indicated action is prohibited.



Be sure to follow the indicated instructions.

Handling Precautions:

Handling Precautions indicate items that the user should pay attention to when handling the MCF.



Note: Notes indicate information that might benefit the user.



This indicates the item or page that the user is requested to refer to.

(1), (2), (3): Numbers within parentheses indicate steps in a sequence or parts of an explanation.

>>: Indicates the result of an operation, details displayed on the personal computer or other devices, or the state of the device after operation.

Safety Precautions

WARNING



Never allow gases that are within explosive limits to pass through this device. Doing so could result in an explosion.



Do not use this device for oxygen gas. Doing so could result in a serious accident.

CAUTION



Be sure to use this device within the flow rate range stated in the specifications. To prevent excessive flow, use a suitable means to control the supply pressure or use a throttle valve or the like to control the flow rate.



If damage could result from the abnormal functioning of this device, include appropriate redundancy in the system design.



If there is a risk of a power surge caused by lightning, use Azbil Corporation's SurgeNon to prevent possible fire or equipment failure.



When carrying the flowmeter or connecting it to the pipe, do not hold it by the measurement module. Doing so could cause damage, or the device could drop, causing an injury.



To avoid damaging this device, do not use it outside of the operating pressure range. Also, do not subject it to a pressure above its pressure resistance.



When maintaining or replacing the measurement module, release the internal pressure of this device before removing the measurement module.



Do not remove or deface the label attached to the batteries.



Do not heat the batteries, throw them into the fire, etc. Doing so may cause them to leak or rupture.



Do not touch any alkaline liquid (electrolyte) that has leaked from a battery.
If alkaline fluid gets into your eyes, it can damage them and cause blindness. If contact with the eyes occurs, rinse them immediately with a large quantity of clean water, such as tap water, without rubbing them. Then get treated by a doctor as soon as possible.
If alkaline liquid comes in contact with your skin or clothes, it may damage your skin. If contact with the skin occurs, rinse the skin immediately with a large amount of clean water (such as tap water).
If alkaline fluid gets into your mouth, rinse your mouth immediately and see a doctor.



Do not use the MCF with the battery box cover off.



Do not drop the MCF or subject it to vibration or shock while in use.



Do not leave the MCF in a high temperature, high humidity place, or where is condensation, or in direct sunlight. Doing so may cause the batteries to heat up, leak, or rupture. In addition, the battery performance or life could be decreased.

CAUTION



Battery life varies depending on the operating environment and the battery type.



Do not remove the mounting bracket from the battery box.



Mount so that the battery box cover is NOT facing down.

The Role of This Manual

Three manuals are available for the MCF. Read appropriate manuals according to your requirements. If you do not have a required manual, contact the azbil Group or your dealer. Additionally, you can download necessary manuals from <http://www.azbil.com>.

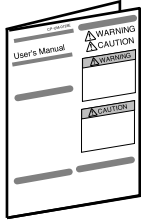

MCF Air Flowmeter Battery-Driven Model User's Manual for Installation Manual No. CP-UM-5632JE

This manual is supplied with the device. Personnel in charge of design and/or manufacture of a system using this device must thoroughly read this manual. This manual describes the safety precautions, installation, wiring, list of parameters, and primary specifications.

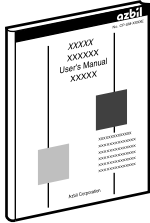

Battery-Powered MCF Air Flowmeter User's Manual for Installation and Configuration

Manual No. CP-SP-1320E

This manual. The manual describes the hardware and all functions of this device. Personnel in charge of design, manufacture, operation, and/or maintenance of a system using this device must thoroughly read this manual. It describes installation, wiring, functions and settings, operating procedures, troubleshooting, and specifications.

Contents

Conventions Used in This Manual	
Safety Precautions	
The Role of This Manual	

Chapter 1. OVERVIEW

■ Summary.....	1
■ Features	1
■ Model selection guide.....	2
■ Optional parts (sold separately).....	3

Chapter 2. PART NAMES AND FUNCTIONS

■ Parts name and functions.....	4
---------------------------------	---

Chapter 3. MOUNTING AND WIRING

■ Installation location	5
■ Excessive flow rate	5
■ Piping.....	6
■ Battery box and terminal locations	14
■ Wiring.....	15

Chapter 4. FUNCTIONS

■ Display.....	17
■ Flow rate display unit.....	17
■ Integration function.....	18
■ Event output.....	18
■ Selection of pressure correction for pipe direction.....	19
■ Reference temperature selection	19
■ Low flow cutoff	19
■ Self-diagnosis function	19
■ Data storage.....	20
■ Standby mode	20

Chapter 5. SETTING AND OPERATION

■ State transitions	21
■ Function setup	22
■ Parameter setup	25
■ Device information display	29
■ Other indications	30
■ Resetting integrated data	30
■ Maintenance mode	30

Chapter 6. MAINTENANCE AND TROUBLESHOOTING

■ Maintenance	33
■ Troubleshooting	36

Chapter 7. SPECIFICATIONS

■ General specifications	38
■ Environmental conditions	41
■ External dimensions	42
■ Pressure loss	45

Chapter 1. OVERVIEW

■ Summary

The MCF air flowmeter uses a μF (Micro Flow) sensor in its sensing unit. The μF sensor is a thermal flow speed sensor which uses proprietary technology. Integrating this ultra-miniature flow speed sensor with high-grade channel design technology has achieved high accuracy and wide rangeability.

■ Features

- Incorporates a thermal flow speed Micro Flow sensor. With the silicon micro-machining and the thin-film forming technologies, the μF sensor is a mere 1.7 mm square and 0.5 mm thick, and features high sensitivity and fast response.
- The MCF is powered by 4 AA alkaline batteries in an external battery box that can be mounted on a pipe or wall.
- Because this device is a mass flowmeter, its readings are not affected by temperature or pressure.
- A bypass structure using orifices affords a wider flow rate range per pipe size than previous mass flowmeters, with low pressure loss.
- Dust tightness is improved by the bypass structure and flow path design.
- Self-diagnostic function for easy handling of malfunctions.
- Measurement module is detachable, so maintenance can be done without removing the flowmeter.
- Measurement module can be swapped between the MCF0250, MCF0400 and MCF0500.
- Display unit can be rotated, for viewing from the desired direction.

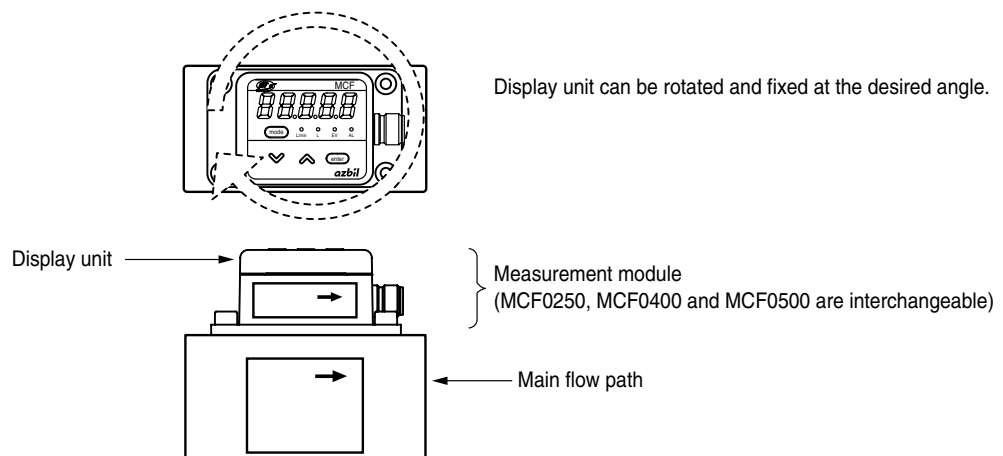

■ Model selection guide

Basic model No.	Pipe size Flow rate range	Material	Connected	Gas type	Power/output/comm.	Option (1)	Option (2)	Option (3)	Design code	Description
MCF										MCF Air flowmeter
	0080									8A (1/4B), 200L/min, full scale
	0150									15A (1/2B), 500L/min, full scale
	0151									15A (1/2B), 1000L/min, full scale
	0250									25A (1B), 3000L/min, full scale
	0400									40A (1 1/2B), 6000L/min, full scale
	0500									50A (2B), 12000L/min, full scale
		A								Body: aluminum alloy Rubber: HNBR
			R							Rc thread
			G							G thread
				N						Air/nitrogen
					B01					4 AA alkaline batteries/ event output
						0				None
							B			With battery box
								0		None
									D	Inspection certificated provided
									Y	With traceability certification
									0	Product version

■ Optional parts (sold separately)

Name	Model number	Cable length	Cable properties	Lead color
Cable with connector exclusive for MCF series	PA5-4ISX2SK PA5-4ISX3SK PA5-4ISX5SK	2m 3m 5m	Oil resistant, bend-tolerant Flame-resistant cable UL2464 EN-compliant	1: Brown 2: White 3: Blue 4: Black
	PA5-4ISX2HK-E PA5-4ISX3HK-E PA5-4ISX5HK-E	2m 3m 5m	Oil resistant Flame-resistant cable UL2464 EN-compliant	
Extension cable with relay connector	PA5-4ISB2SK PA5-4ISB3SK PA5-4ISB5SK	2m 3m 5m	Oil resistant, bend-tolerant Flame-resistant cable UL2464 EN-compliant	
	PA5-4ISB2HK-E PA5-4ISB3HK-E PA5-4ISB5HK-E	2m 3m 5m	Oil resistant, Flame-resistant cable UL2464 EN-compliant	

Name	Model number	Description
Mounting bracket	81446721-001	For MCF0080/0150/0151/0250
Measurement module	81447192-241	For MCF_____A_NB01_____
Battery box	81447374-001	
Cable with relay connector	PA5-4ISB05SK	

Name	Model number	Description
MCF Air Flowmeter	MCF0080ARNB0100_0	Rc 1/4 inch, 200 L/min
	MCF0150ARNB0100_0	Rc 1/2 inch, 500 L/min
	MCF0151ARNB0100_0	Rc 1/2 inch, 1000 L/min
	MCF0250ARNB0100_0	Rc 1 inch, 3000 L/min
	MCF0400ARNB0100_0	Rc 1 1/2 inch, 6000 L/min
	MCF0500ARNB0100_0	Rc 2 inch, 12000 L/min
	MCF0080AGNB0100_0	G 1/4 inch, 200 L/min
	MCF0150AGNB0100_0	G 1/2 inch, 500 L/min
	MCF0151AGNB0100_0	G 1/2 inch, 1000 L/min
	MCF0250AGNB0100_0	G 1 inch, 3000 L/min
	MCF0400AGNB0100_0	G 1 1/2 inch, 6000 L/min
	MCF0500AGNB0100_0	G 2 inch, 12000 L/min

Note: The digit represented by "_" indicates the selection of 0 (no option), D (with inspection certificate), or Y (with traceability certification).

Chapter 2. PART NAMES AND FUNCTIONS

■ Parts name and functions

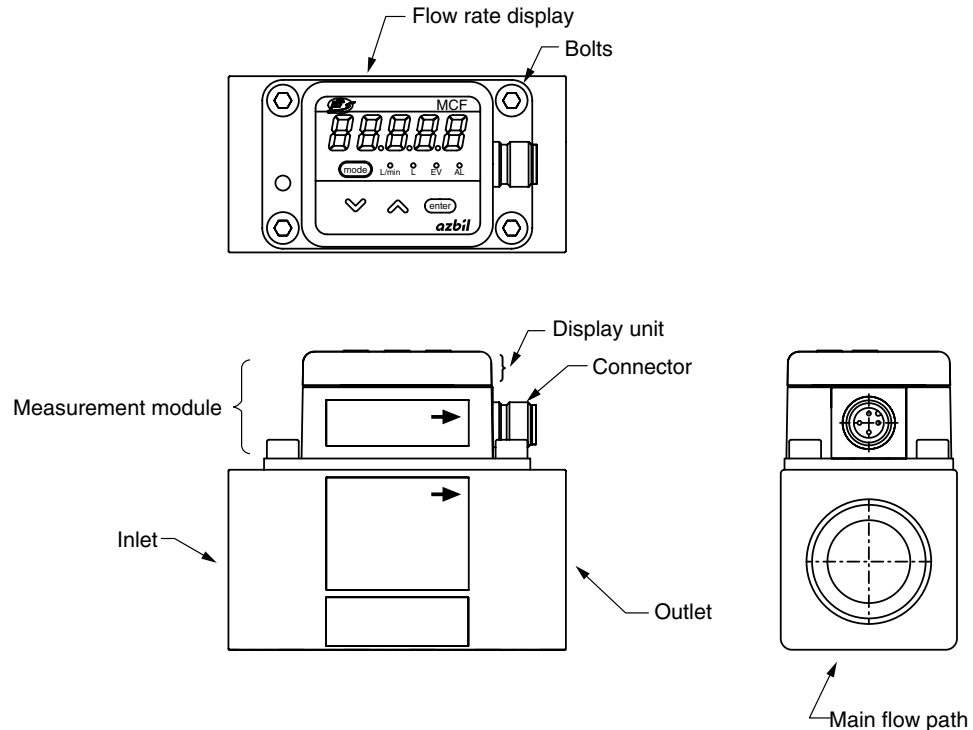

Flow rate display: This 7-segment LED indicates instantaneous flow rate or integrated flow amount. For the integrated flow, the first 4 digits and last 5 digits are displayed separately. The 7-segment display also indicates settings in setting mode and alarm codes when an alarm occurs.

LED lamp:

[L/min]	Lights up while instantaneous flow rate is indicated.
[L]	Lights up while integrated flow is indicated.
[EV]	Synchronized with event output
[AL]	Lights up when an alarm occurs

Keys:

[mode]	Changes the display or switches to setting mode, etc.
[^] [v]	Increases/decreases the value of a setting, changes the display mode, etc.
[enter]	Used to finalize function settings and parameter settings

Main flow path: Connects to pipes. Inlet and outlet are marked.

Measurement module: Removable for maintenance. Can be changed with a new one for the MCF0250, MCF0400 and MCF0500.



Display unit: Can be rotated in a plane parallel to the flow path. Rotates 180° clockwise and 90° counterclockwise, for viewing from any direction.

Connector: Provides the power and signal connections.



Bolts: Fasten the measurement module in the main flow path.

Chapter 3. MOUNTING AND WIRING

WARNING

-  Never allow gases that are within explosive limits to pass through this device. Doing so could result in an explosion.
-  Do not use this device for oxygen gas. Doing so could result in a serious accident.

CAUTION

-  Be sure to use this device within the flow rate range stated in the specifications. To prevent excessive flow, use a suitable means to control the supply pressure or use a throttle valve or the like to control the flow rate.
-  If damage could result from the abnormal functioning of this device, include appropriate redundancy in the system design.
-  If there is a risk of a power surge caused by lightning, use Azbil Corporation's SurgeNon to prevent possible fire or equipment failure.

■ Installation location

Avoid mounting this device in places characterized by any of the following:

- Temperature below -10 °C or above 60 °C (However, if the operating temperature and humidity ranges for the batteries are more narrow than the ranges for the MCF, the ranges for the battery have priority.)
- Humidity exceeding 90 % RH
- Sudden changes in temperature, or condensation
- Corrosive or flammable gases
- Heavy concentration of conductive substances (e.g. dust, salt or iron dust), water droplets, oil mist or organic solvents
- Vibration or shock
- Direct sunlight
- Splashing by water or rain
- Splashing by fluids (e.g. oil, chemicals)
- Constant, heavy splashing by water or dust
- Strong magnetic or electrical fields

■ Excessive flow rate

If the flow rate exceeds the maximum display range, alarm code *AL40* is displayed alternately with the flow rate. Be sure to use the device within the flow rate range stated in the specifications.

■ Piping

● MCF_____R pipe installation cautions

- The MCF is a precision instrument. Do not drop it nor subject it to shock.
- Install so that the direction of gas flow matches the arrow on the side of the MCF.
- Do not apply force to the measurement module during installation.
- When attaching the MCF to the pipe, fix the MCF in place and rotate the pipe to the recommended tightening torque.

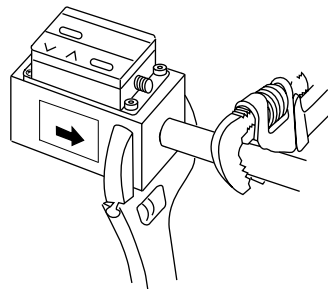

Model number	Pipe size	Recommended tightening torque [N·m]
MCF0080	1/4 inch	12 to 14
MCF0150	1/2 inch	31 to 33
MCF0151	1/2 inch	31 to 33
MCF0250	1 inch	36 to 38
MCF0400	1 1/2 inch	59 to 61
MCF0500	2 inch	74 to 76

- Do not allow foreign matter to enter the MCF. If rust, water droplets, oil mist or dust from the pipe enters the device, measurement, control error, or damage may occur. Before installation, be sure to flush the upstream and downstream piping thoroughly to remove welding fume particulate and dust.
- Coat with an appropriate amount of sealant, but do not coat the top two threads. Doing so might cause measurement error or damage.
- When connecting a piping element such as a pipe with a different diameter, a regulator, a filter, or a valve on the upstream side, use the recommended straight pipe section. Failure to do so could cause a measuring error.
 ➡ “Accuracy and straight pipe length” (page 10)
- If a reducer or tube fitting is connected without a straight pipe section, the display might indicate a negative flow rate even though air is flowing in the positive direction.
 “Straight pipe section” refers to a straight pipe with the same diameter as the MCF port. The following types of pipe are suitable: *Carbon Steel Pipes for Ordinary Piping* (JIS G3452), ANSI schedule 40 or less; *Carbon Steel Pipes for Pressure Service* (JIS G3454), or ANSI schedule 40 or less; *Stainless Steel Pipes* (JIS G3459).
- Although there are no restrictions of mounting direction, if the MCF is mounted on a horizontal pipe and the display faces to the side, a measuring error can be caused by the mounting direction.
 ➡ “Mounting direction” (page 8)
 Also, if the unit is mounted on a horizontal pipe with the display facing downward, foreign matter (rust, water droplets, oil mist, dust) in the pipes might accumulate in the sensor, causing measuring error or damage.
- Do not install this device near the outlet of a compressor or bellows pipe, or in a location where the regulator and the check valve cause a hunting phenomenon. Doing so could cause measurement error.

● **MCF _____ G pipe installation cautions**

- The MCF is a precision instrument. Do not drop it nor subject it to shock.
- Install so that the direction of gas flow matches the arrow on the side of the MCF.
- Do not apply force to the measurement module during installation.
- Do not allow foreign matter to enter the MCF. If rust, water droplets, oil mist or dust from the pipe enters the device, measurement error, control error, or damage may occur. Before installation, be sure to flush upstream and downstream piping thoroughly to remove foreign matter.
- Be sure to use the gasket between the pipe and the MCF.
- When connecting a piping element such as a pipe with a different diameter, a regulator, a filter, or a valve on the upstream side, use the recommended straight pipe section. Failure to do so could cause a measuring error.
 - ☞ “Accuracy and straight pipe length” (page 10)
- If a reducer or tube fitting is connected without a straight pipe section, the display might indicate a negative flow rate even though air is flowing in the positive direction.

“Straight pipe section” refers to a straight pipe with the same diameter as the MCF port. The following types of pipe are suitable: Carbon Steel Pipes for Ordinary Piping (JIS G3452), ANSI schedule 40 or less; Carbon Steel Pipes for Pressure Service (JIS G3454), or ANSI schedule 40 or less; Stainless Steel Pipes (JIS G3459).
- Although there are no restrictions of mounting direction, if the MCF is mounted on a horizontal pipe and the display faces to the side, a measuring error can be caused by the mounting direction.
 - ☞ “Mounting direction” (page 8)

Also, if the unit is mounted on a horizontal pipe with the display facing downward, foreign matter (rust, water droplets, oil mist, dust) in the pipes might accumulate in the sensor, causing measuring error or damage.
- Do not install this device near the outlet of a compressor or bellows pipe, or in a location where the regulator or the check valve causes hunting. Doing so could cause measurement error.

● **Mounting direction**

Normally the MCF is mounted on a horizontal pipe with the display unit facing upward. Though the mounting position is unrestricted, measurement error might be caused by the display direction.

- Normal position on horizontal pipe with display facing upward (Position 1)

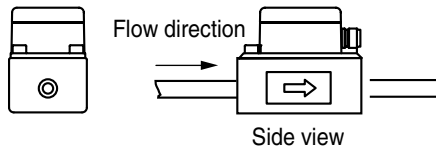

- Horizontal pipe with display rotated to the right as seen from air inlet (Position 2)

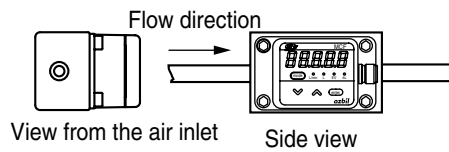

- Horizontal pipe with display rotated to the left as seen from air inlet (Position 3)

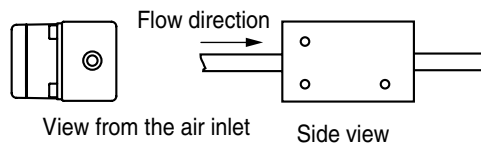

- Horizontal pipe with display facing downward (Position 4)

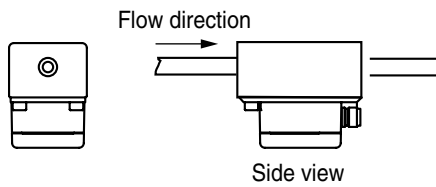

- Vertical pipe (Position 5)

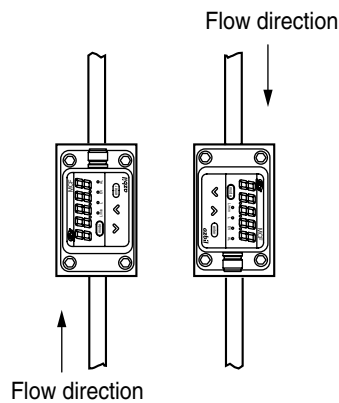

- **Horizontal pipe with the display facing right as seen from the air inlet (Position 2)**

Operating pressure range	Flow rate range	Instantaneous flow rate deviation
0 to 1 MPa	5 to 100 % of full scale flow rate	0.5 % FS per 0.1MPa ±1 digit or less
-0.07 to 0 MPa	5 to 100 % of full scale flow rate	0.5 % FS per 0.01MPa ±1 digit or less

Example: When the MCF is mounted on horizontal piping with the display unit facing to the right as seen from the air inlet, the instantaneous flow rate deviation is 1.5 % FS ±1 digit or less as compared with the accuracy in the normal position at 0.3MPa.

$$0.5 \% \text{ FS} / 0.1 \text{ MPa} \times 0.3 \text{ MPa} = 1.5 \% \text{ FS}$$

Note:  Maintenance mode settings table (page 31, for error correction)

- **Horizontal pipe with the display facing left as seen from the air inlet (Position 3)**

Operating pressure range	Flow rate range	Instantaneous flow rate deviation
0 to 1 MPa	5 to 100 % of full scale flow rate	-0.5 % FS per 0.1MPa ±1 digit or less
-0.07 to 0 MPa	5 to 100 % of full scale flow rate	-0.5 % FS per 0.01MPa ±1 digit or less

Example: When the MCF is mounted a horizontal piping and the display unit looks to the left from the air inlet, the instantaneous flow rate deviation is -1.5 % FS ±1 digit or less as compared with the accuracy in the normal position at 0.3MPa.

$$-0.5 \% \text{ FS} / 0.1 \text{ MPa} \times 0.3 \text{ MPa} = -1.5 \% \text{ FS}$$

Note:  Maintenance mode settings table (page 31, for error correction)

Handling Precautions

- When the MCF is mounted on horizontal piping with the display facing to the right or left side as seen from the air inlet, we recommend setting the low flow cutoff at 5 (±5 % of the full scale flow rate) or less. If no low flow cutoff is set, the integrated value might accumulate even without an air flow.

- **Horizontal pipe with the display facing downward and vertical pipe (Positions 4, 5)**

The characteristics of the MCF do not change as compared with the normal position. However, if the MCF is mounted on horizontal piping with the display unit downward, accuracy might decrease due to accumulated moisture, mist or dust from the air.

- **Filter**

- If there is a possibility of foreign matter entering the device, install a filter, strainer or mist trap upstream capable of eliminating foreign matter larger than 1 μm in diameter.
- If an oil mist can be expected frequently, be sure to install a mist separator.
Model number: MFF25S / MFF25L
 Specifications sheet No. CP-SS-1824E
- Inspect and replace the filter periodically.

- Accuracy and straight pipe length
 - Connection with different size piping, valve or filter

Install straight pipes as needed with the lengths given in the table below.
 If a device that is not listed in the table is installed either upstream or downstream, contact the azbil Group for the length of the straight pipe section.
 If reverse flow is also expected, it is necessary to have the same length of straight pipe downstream as upstream.

Pipe or connected device	Location in relation to the MCF	Straight pipe section for this device	
		For accuracy within specifications ($\pm 3\%$ FS)	For accuracy within $\pm 5\%$ FS
MFF25S mist separator for MCF0080/0150/0151/0250 *2	Upstream	10D	(Not required)
MFF25L mist separator for MCF0400/0500 *2	Upstream	20D	(Not required)
Pipe one size larger in dia. (connected with reducer) *3, 4 MCF0080 3/8 inch→1/4 inch MCF0150/0151 3/4 inch→1/2 inch MCF0250 1 1/4 inch→1 inch MCF0400 2 inch→1 1/2 inch	Upstream	5D	(Not required)
	Downstream	(Not required)	(Not required)
Pipe one size larger in dia. (connected with reducer) *3, 4 MCF0500 2 1/2 inch→2 inch	Upstream	10D	5D
	Downstream	5D	5D
Pipe one size smaller in dia. (connected with enlarging pipe) *3, 5 MCF0080 1/8 inch→1/4 inch MCF0150/0151 3/8 inch→1/2 inch MCF0250 3/4 inch→1 inch MCF0400 1 1/4 inch→1 1/2 inch	Upstream	20D	5D
	Downstream	(Not required)	(Not required)
Pipe more than one size smaller in dia. (connected with enlarging pipe) *3, 5 MCF0500 1 1/2 inch→2 inch	Upstream	25D	10D
	Downstream	5D	5D
Single elbow *6	Upstream	10D	(Not required)
	Downstream	(Not required)	(Not required)
Double elbow *6	Upstream	10D	10D
	Downstream	(Not required)	(Not required)
Ball valve (full-bore type full open) *7	Upstream	(Not required)	(Not required)
	Downstream	(Not required)	(Not required)
Regulator for MCF0080 *8	Upstream	200D	(Not required)
	Downstream	10D	(Not required)
Regulator for MCF0150/0151/0250/0400/0500 *8	Upstream	30D	(Not required)
	Downstream	5D	(Not required)
Air filter	Upstream	25D	(Not required)

*1: Do not connect a carbon steel pipe for pressure service (JIS G3454) or stainless steel pipe (JIS G3459) that is larger than schedule 40. Doing so might cause a deterioration of accuracy. (If the pipe schedule number is larger, the inner pipe diameter is smaller, resulting in reduced accuracy.)

*2: The straight pipe section lengths given in the right-hand columns above are for connection of a filter the same size (internal diameter) as the MCF.

*3: MCF models and connecting pipe sizes are shown below.

Model No./Pipe size	1/8 inch	1/4 inch	3/8 inch	1/2 inch	3/4 inch
MCF0080	▲	●	+		
MCF0150/0151			▲	●	+

Model No./Pipe size	3/4 inch	1 inch	1 1/4 inch	1 1/2 inch	2 inch	2 1/2 inch
MCF0250	▲	●	+			
MCF0400			▲	●	+	
MCF0500				▲	●	+

- ▲ Pipe one size smaller than the MCF
- Pipe the same size as the MCF
- + Pipe one size larger than the MCF

*4: The figure below shows an example of the MCF0080 connected with a reducer. The accuracy is within the specification range ($\pm 3\%$ FS).

When connecting the MCF to a pipe 1 size larger than the MCF port (for example, the MCF0080 to a 1/2 inch pipe), to determine the straight pipe length, use the section of the table marked “Pipe one size larger in dia. (connected with reducer).”

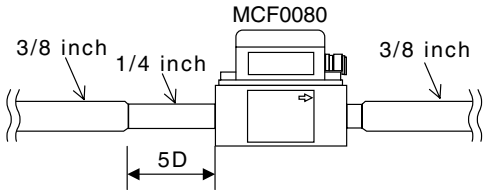

*5: The figure below shows an example of the MCF0150 connected with an enlarging pipe. The accuracy is within the specification range ($\pm 3\%$ FS).

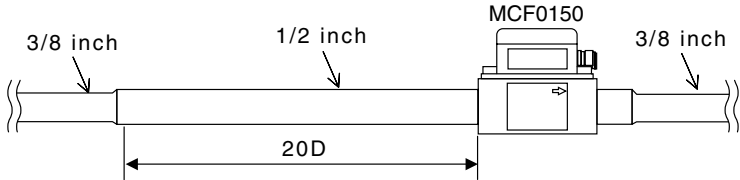

Do not connect a smaller size pipe to the MCF without a straight pipe section. Doing so might cause a reverse flow in the measurement module, even though there is a regular forward flow in the main flow path. Therefore the display might indicate a negative value or an extremely low flow rate compared with the actual rate.

When connecting the MCF to a pipe 1 size smaller than the MFC port (for example, the MFC0150 to a 1/4 inch pipe), to determine the straight pipe length use the section of the table marked “Pipe one size smaller in dia. (connected with reducer).” In addition, on the upstream side add 5D to the straight pipe length.

* The specified length is the straight pipe length when connecting a pipe one size smaller than the MCF.

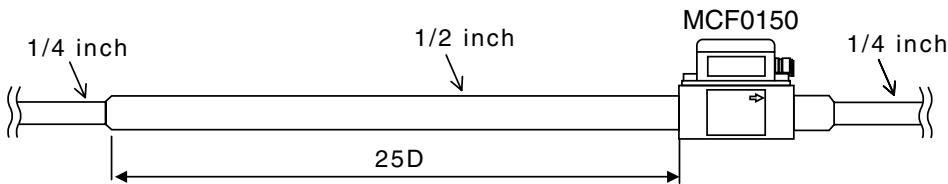

*6: The figures below show examples of connection with a single elbow and double elbow.

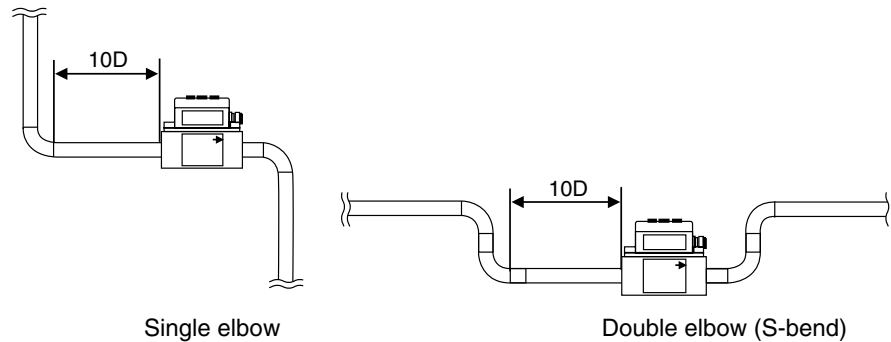

*7: This valve does not have an internal throttle. If possible, install a flow regulating valve downstream from the MCF.

*8: A regulator should be 200D away from this device. The pipe from the regulator to this device may consist of an air tube and elbow. However, if the elbow is connected to this device, use the necessary straight pipe section for the elbow.

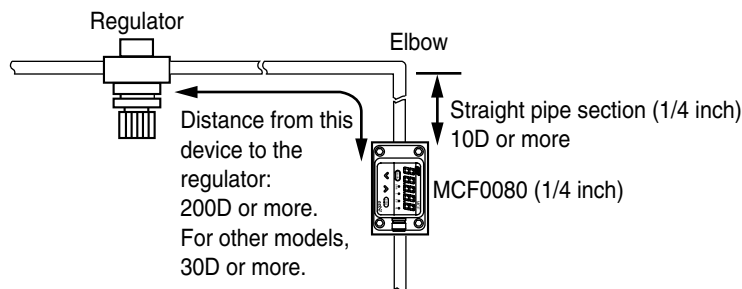

• **Connection with a tube fitting for air supply piping**

If connecting a tube fitting for air supply piping to the MCF, install a straight pipe section between them as shown below.

Connecting a smaller size pipe to the MCF without a straight pipe section might cause a reverse flow in the measurement module, even though there is a regular forward flow in the main flow path. Therefore the instantaneous flow rate display might indicate -0 (negative flow rate) or an extremely low flow rate compared with the actual rate.

The straight pipe lengths listed below apply only when there is a straight pipe fitting. If the pipe fitting has an elbow, add 5D to the straight pipe length. The characteristics are the same as those of about a 300 mm straight pipe section from the fitting.

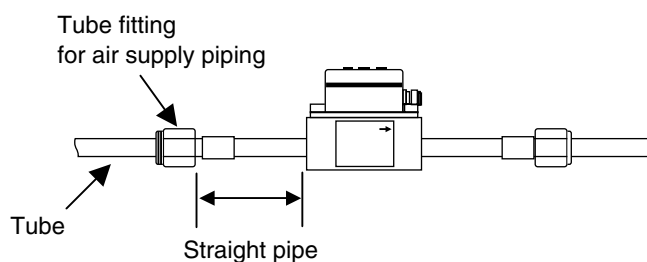

Pipe or connected device	Location in relation to the MCF	Straight pipe section for this device	
		For accuracy within specifications ($\pm 3\%$ FS)	For accuracy within $\pm 5\%$ FS
Tube fitting for air supply piping Tube dia.: 8 mm (internal dia.: 6 mm) (MCF0080)	Upstream	15D	5D
	Downstream	Not needed	Not needed
Tube fitting for air supply piping Tube dia.: 12 mm (internal dia.: 8 mm) (MCF0080)	Upstream	5D	Not needed
	Downstream	Not needed	Not needed
Tube fitting for air supply piping Tube dia.: 12 mm (internal dia.: 8 mm) Tube dia.: 16 mm (internal dia.: 12 mm) (MCF0150)	Upstream	10D	5D
	Downstream	Not needed	Not needed
Tube fitting for air supply piping Tube dia.: 16 mm (internal dia.: 12 mm) (MCF0151)	Upstream	20D	10D
	Downstream	Not needed	Not needed
Tube fitting for air supply piping Tube dia.: 12 mm (internal dia.: 8 mm) Tube dia.: 16 mm (internal dia.: 12 mm) (MCF0250)	Upstream	10D	8D
	Downstream	5D	5D

• **Rotation of display unit**

The display unit can be rotated 90° counterclockwise and 180° clockwise from the state of factory shipment (see the figure shown below).

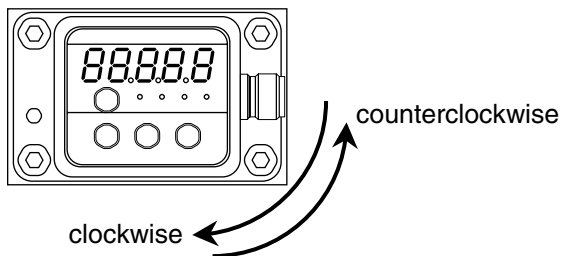

If the display is rotated beyond the range of movement stated above, the internal connector may be disconnected, disabling the display unit.

■ Battery box and terminal locations

● Mounting the battery box

Mount the battery box securely on the pipe using U bolts, or on a wall using screws (U-bolt nut tightening torque: 0.7 -1.0 N·m).

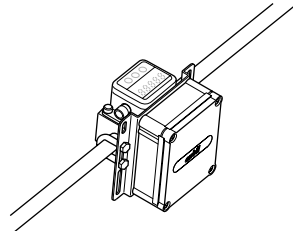

Mounting the battery box on a pipe (MCF0080/MCF0150/MCF0151)

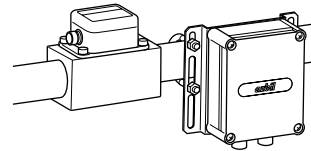

Mounting the battery box on a pipe (all models)

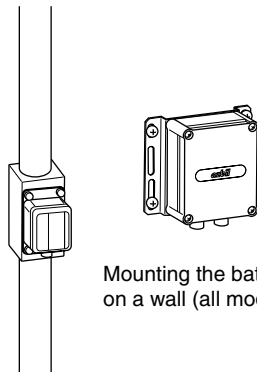

Mounting the battery box on a wall (all models)

● Connecting the MCF and battery box

- Connect the MCF and battery box connector A using the cable provided.
- To send output signals from the MCF, connect the dedicated cable (sold separately) to battery box connector B.

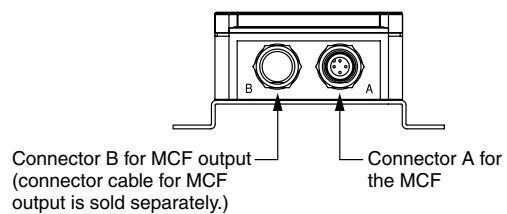
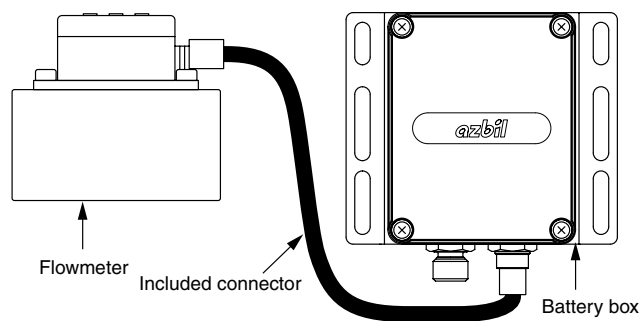

● Mounting the alkaline batteries

- Remove the battery box cover and set 4 AA alkaline batteries in the holder. Then attach the cover and tighten the screws
- * If the MCF display does not turn on, try reinserting the batteries.
- * Tightening torque: 1.3 -1.6 N·m.

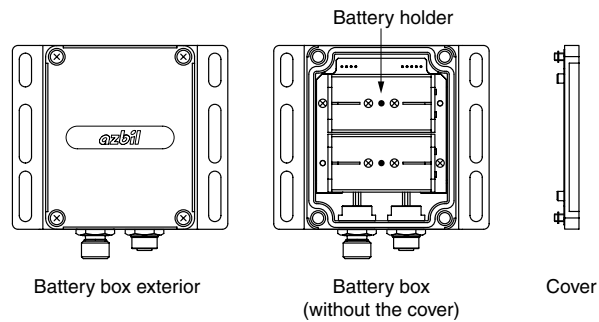

After inserting the batteries, check the battery level on the device information display (page 29).

■ Wiring

● Cautions for wiring

- Keep the MCF wiring (conduit) away from power wiring or high voltage wires.
- When connecting the connector, push the two parts together, and then tighten the nut by hand to 0.4 to 0.6 N·m. Improper tightening can damage the MCF, or lead to a loss of the IP65 seal, or allow the connector to come loose due to vibration.
- Do not pull the cable forcibly, and do not lift the MCF by the cable (pull-out strength 40 N max., bending force 20 N max.) Do not bend the cable repetitively or put a constant pulling stress on it.
- Do not rotate the cable where it joins the connector (see figure). Doing so might rotate the connector, twisting and damaging the wires inside.

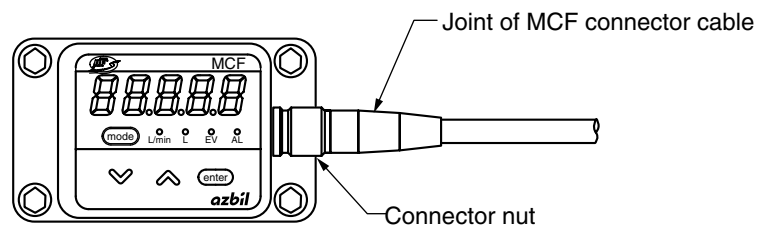

- Before wiring, be sure to remove the batteries.
- Keep water away from the cable and from the end of the connector while wiring.
- Be sure to check that the wiring is correct before turning the power on. Incorrect wiring could cause damage or malfunction.

● **Battery box output (connector B)**

Pin number	Signal	
1	None	None
2	AL	Alarm event
3	COM	COM
4	EV	Event output

Wire color and pin number for MCF connector cable

Pin number	Signal	Line color
1	None	Brown
2	AL	White
3	COM	Blue
4	EV	Black

● **Wiring example**

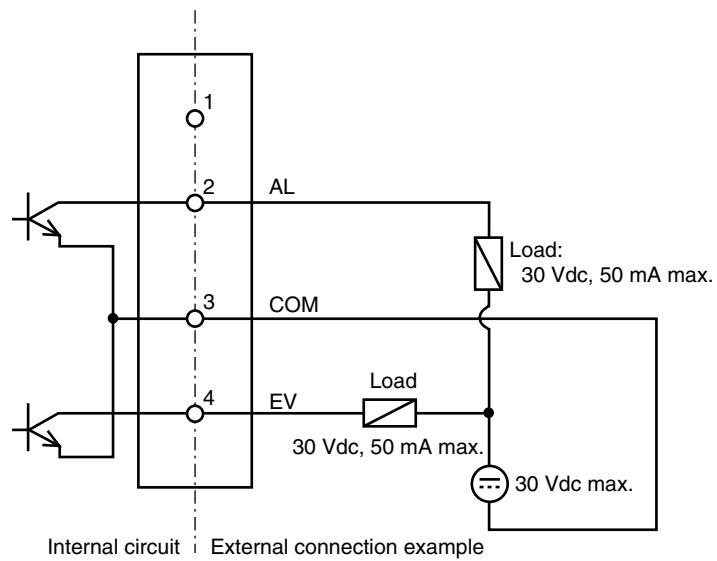

Chapter 4. FUNCTIONS

■ Display

Pressing any key when the display is off will turn it on again. After it turns on, if the amount of time specified in **C05** has passed with no key operation, the display turns off automatically.

● Instantaneous flow rate display and integrated flow display

The user can display either instantaneous flow rate or integrated flow total on the 7-segment display.

The maximum number of digits displayed for instantaneous flow rate is 5. For the integrated flow, 9 digits are displayed by showing the first 4 digits and the last 5 digits alternately. When the first 4 digits of the integrated flow total are displayed, the leftmost digit of the 7-segment display indicates “H” for count-up integration and “L” for count-down. Without this letter, the display can be recognized as showing the last part of the integrated flow total.

If there is a reverse flow, the instantaneous flow rate is shown as -0 regardless of the amount of flow.

● Peak instantaneous flow rate and lowest instantaneous flow rate

The peak instantaneous flow rate and the lowest instantaneous flow rate during the measurement period can be displayed. The measurement period can be restarted by operating the keys.

● Device information display

The model ID, firmware version, total integrated flow since shipping, and integrated flow before resetting are accessed with this function.

● Status indicator

[L/min]: Lit up during instantaneous flow rate display

[L]: Lit up during integrated flow display

[EV]: Lit up while event output is ON

[AL]: Lit up when an alarm occurs

■ Flow rate display unit

The units for instantaneous flow rate and integrated flow can be changed.

Example:

C02 setting	00	01	02	03
Flow rate unit	L/min, L	m ³ /h, m ³	m ³ /min, m ³	kg/h, kg
Instantaneous flow rate	200	12.0	0.200	15.5
Integrated flow amount	100000000	100000.000	100000.000	100000.000

The conversion formulas from [L/min] to other flow rate units are as follows:

$$\text{m}^3/\text{h} = \text{L}/\text{min} \times 60 \div 1000$$

$$\text{kg}/\text{h} = \text{L}/\text{min} \times 60 \div 1000 \times 1.293 *$$

* The density of air at 0 °C and 101.325kPa (abs) is set at 1.293.

! Handling Precautions

- If you change the flow rate engineering unit, affix the appropriate unit label (included with the MCF) on top of the current label.

■ Integration function

Either integration count-up or integration count-down can be selected in the function setup.

- If the integrated value exceeds 999999990, it reverts to 0 and counting continues.
- In the integrated countdown function, the integrated value decreases from a preset value to 0. When it reaches 0, counting stops.
- The (count-up) integrated value is saved to nonvolatile memory every 10 minutes. Therefore, depending on when the power is turned off, up to 10 minutes of integration data may be lost at shutoff. The integrated countdown value is not saved to nonvolatile memory.
- To reset the integrated value, push and hold the [\wedge] key and the [\vee] key at the same time for 5 seconds or more while the integrated flow (either 4-digit or 5-digit part) is displayed. The integrated count will change to 0. In the case of countdown, the count is reset to the amount set in the integrated flow event setup. When the integrated data is reset, the data before resetting is stored in nonvolatile memory.

■ Event output

● Event type

The event type can be selected from the table below.

Event type	Name	Operation
Instantaneous flow rate switch	Instantaneous flow rate upper limit	Output turns on when the PV exceeds the value set for instantaneous flow rate event 1 in the parameter setup.
	Instantaneous flow rate lower limit	Output turns on when the PV falls below the value set for instantaneous flow rate event 1 in the parameter setup.
	Instantaneous flow rate within range	Output is on when the PV is within the range set for instantaneous flow rate events 1 and 2 in the parameter setup.
Integrated flow switch	Integrated count-up	Output turns on when the integrated flow exceeds the value set for integrated flow event in the parameter setup.
	Integrated countdown	Output turns on when the integrated data becomes 0, decreasing from the value set for integrated flow event in the parameter setup.
Integrated pulse output	Pulse output (Pulse weight: 125 ms)	Outputs an integration pulse with the pulse weight that is specified in the event output settings of the function setup.
Alarm output	Alarm occurrence	Output turns on when an alarm occurs.

*: Pulse-weight

Model No.	Setup [L/pulse]			Setup [m ³ /pulse, kg/pulse]		
	Minimum unit	10 times the minimum unit	100 times the minimum unit	Minimum unit	10 times the minimum unit	100 times the minimum unit
MCF0080	10	100	1000	0.01	0.1	1
MCF0150	10	100	1000	0.01	0.1	1
MCF0151	10	100	1000	0.01	0.1	1
MCF0250	100	1000	10000	0.1	1	10
MCF0400	100	1000	10000	0.1	1	10
MCF0500	100	1000	10000	0.1	1	10

● Event hysteresis

If the instantaneous flow rate switch is selected as the event type, a hysteresis (operation gap) can be set. Setting range is 0 to 10 % FS at 1% interval.

● Event on delay

If the instantaneous flow rate switch is selected as the event type, a delay before the event turns ON can be set. Setting range is 0 to 60 seconds at 1 second interval.

● Event standby

If the instantaneous flow rate lower limit event is selected as the event type, the event output can be temporarily disabled until the flow rate has exceeded the lower limit once after the power is turned on.

■ Selection of pressure correction for pipe direction

By means of the operating pressure setting, the MCF can cancel the effects of pressure characteristics by adjusting the output.

■ Reference temperature selection

The reference temperature can be set at 1 °C intervals between 0 to 35 °C. The factory setting is 0 °C.

■ Low flow cutoff

The low flow cut can be set at 1 % intervals from 1 to 50 % of the full-scale flow rate. The factory setting is 1 %.

As an example of how the low flow cutoff operates, if it is set at 1 %, the display shows “0” for flow rates from 0 to 1 % of the full-scale flow rate. This setting affects the instantaneous flow rate, integrated flow, and analog output.

■ Self-diagnosis function

If there is an abnormal output from the sensor, or a memory error, the MCF's self-diagnosis function turns on an alarm. For details on alarms, see Alarm codes and remedies in chapter 6, Maintenance and Troubleshooting.

■ **Data storage**

Stored in a nonvolatile memory.

Recording data: Functions setting, parameter setting, integrated value*, instantaneous flow rate peak value*

* Integrated value and instantaneous flow rate value are recorded at every 10 minutes.

■ **Standby mode**

To reduce power consumption, the MCF automatically switches between two measurement cycles, 1 s (normal mode) and 10 s (standby mode).

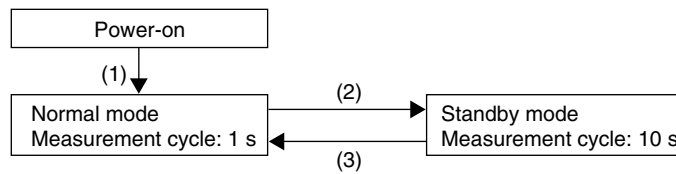

(1)	Start-up processing after power-on (battery insertion)
(2)	When the LED is off and the flow rate is 0 or less for 15 seconds or longer.
(3)	When normal (forward) flow is detected or the LED is lit because a key was pressed.

Chapter 5. SETTING AND OPERATION

■ State transitions

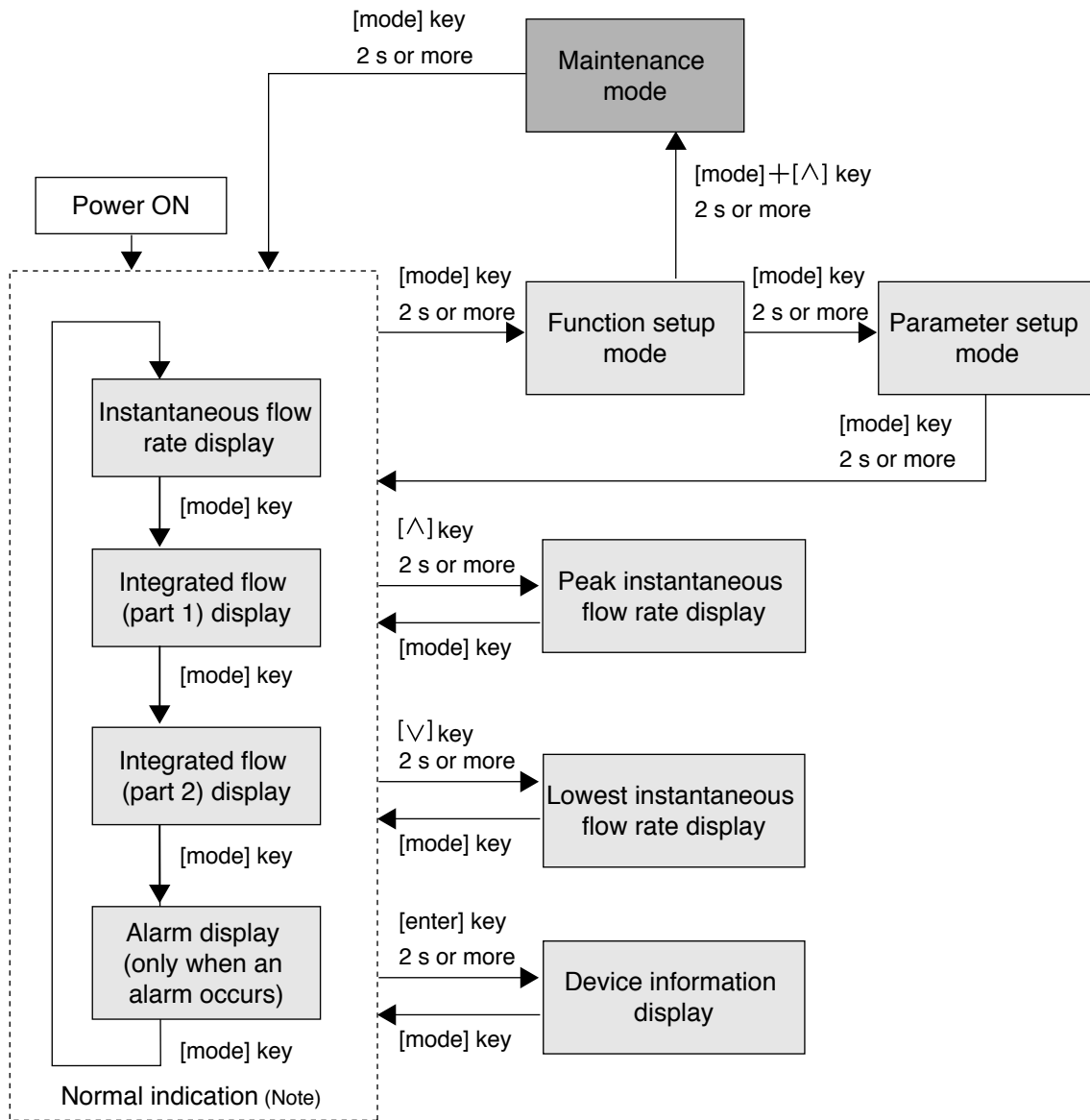

Note 1: Normal indication means display of the instantaneous flow rate, integrated flow last five digits, integrated flow first four digits, or no-display, depending on the setting of function setup C04. If an alarm occurs, the alarm code and normal indication alternate every two seconds.

Note 2: The display turns off automatically after the time specified in C05 has passed with no key operation. The LED for the instantaneous flow rate blinks at 4-second intervals (10-second intervals in standby mode) while the display is off. However, if any key is pressed, the display will turn on again.

! Handling Precautions

- Do not press the console keys with a sharp object like a mechanical pencil or needle. Doing so will damage the keys.

■ Function setup

● Setup method

(1) Push and hold the [mode] key for 2 seconds or more in the normal indication mode.

>> The function number is displayed in the first 3 digits and the current setting is displayed in the last 2 digits.

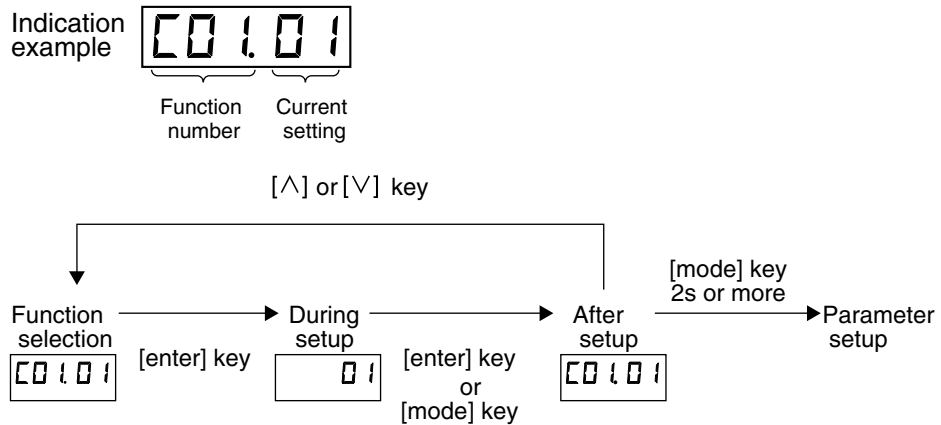

(2) Change the function setup to the desired item by pushing [V] or [^], and then press [enter].

>> The function setup number goes out, and the only the setting (in the last 2 digits) is shown.

(3) Change the setting with the [V] or [^] key, and then press [enter].

>> The changed setting is now entered, and both the function number and the setting are shown.

If the [mode] key is pressed instead of the [enter] key, the MCF exits setup mode without changing the setting.

(4) Repeat steps (2) to (3) if you want to continue setup.

To exit setup mode, press and hold the [mode] key for 2 seconds or more to move to parameter setup, and then again press and hold the [mode] key for 2 seconds or more to return to normal indication mode.

! Handling Precautions

- If there is no key operation for 30 seconds or more, processing stops and the display turns off. Since the mode will revert to the normal indication mode when the display turns on again, as necessary, return to step (1) to begin the interrupted setup again.

● Function settings

Func No.	Name	Settings	Factory setting	Description
C01	Key lock setting	00: Unlocked 01: Key locked	00	Even with the keys locked, it is possible to cancel the key lock. If any key is pressed while the keys are locked, "LoL." is displayed.
C02	Flow rate units	Unit of instantaneous flow rate and integrated flow *1 00: L/min, L 01: m ³ /h, m ³ 02: m ³ /min, m ³ 03: kg/h, kg	00	Note: If the units are changed, the integrated flow total remains in the previous units, without automatic conversion. Therefore, after changing the units it is necessary to reset the current integrated flow count. Also, reset $\overline{R0.20}$ (in Parameter settings). • When this setting is changed, the peak value and the lower value are reset.
C03	Event output	00: Not used 01: Instantaneous flow rate upper limit 02: Instantaneous flow rate lower limit 03: Within range for instantaneous flow rate 04: Instantaneous flow rate upper limit (reversed output) 05: Instantaneous flow rate lower limit (reversed output) 06: Within range for instantaneous flow rate (reversed output) 07: Set value reached by integrated flow count-up 08: Set value reached by integrated flow count-up (reversed output) 09: Zero reached by integrated flow countdown 10: Zero reached by integrated flow countdown (reversed output) 11: Integrated pulse output (minimum unit) *2 12: Integrated pulse output (minimum unit × 10) *2 13: Integrated pulse output (minimum unit × 100) *2 14: Alarm 15: Alarm (reversed output)	00	Reversed output is high when the event is OFF and low when the event is ON. To cancel the event output for integrated flow count-up or countdown, reset the count or change the event output type. Since models with RS-485 communications have no event output terminals, the EV LED lamp indicates on event but not event output. For details on the pulse weights for 11 - 13, see the pulse weight table on page 19.
C04	Normal indication	00: Instantaneous flow rate indication 01: Last digits of integrated flow 02: First digits of integrated flow	00	Selects the basic display that is shown immediately after battery replacement.
C05	Waiting time for display OFF	00: 5 s 01: 10 s 02: 15 s	00	The waiting time for display OFF can be changed. However, in function setup mode, parameter setup mode, or maintenance mode, the waiting time for display OFF is extended to 30 s whenever a key operation is made after the settings display is shown.

Func No.	Name	Settings	Factory setting	Description
006	Alarm event	00: Alarm event (general) 01: AL59 battery alarm 02: AL40 over range	00	An alarm event can be output from terminal AL. If 00 is selected, the output is the same as when 14 is selected in 003. The "AL" LED does not depend on the alarm event selected. It lights up regardless of the kind of alarm.
007	Event standby	00: Disabled 01: Enabled	00	If 02 or 05 is selected in 003, the event standby will operate until the instantaneous flow rate event setting is exceeded once after power is turned on.
008	Gas type	00: Air, nitrogen (fixed)	00	
010	Operating pressure (correction for pipe direction)	00: [No correction] 01: [Direction 2] 0.5 MPa min. 02: [Direction 3] 0.5 MPa min.	00	If the operating pressure is high, this function is used to correct the pressure dependence due to pipe direction. For [Position 1] or [Position 4], select [00: No correction] regardless of the operating pressure. For [Position 2] or [Position 3], select [00: No correction] if the operating pressure is less than 0.5 MPa.
011	Reference temperature	00 to 35 °C (every 1 °C)	00	If the setting is changed, the peak value and the lowest value are reset.

*1: If you change the flow rate engineering unit, affix the appropriate unit label (included with the MCF) on top of the current label.

*2: Minimum unit

MCF0080/0150/0151/0250: 10 L/pulse (0.01 m³/pulse, 0.01 kg/pulse)

MCF0400/0500: 100 L/pulse (0.1 m³/pulse, 0.1 kg/pulse)

Parameter setup

Setup method

- Push and hold the [mode] key 2 seconds or more in the normal indication mode. The device enters function setup mode. Again press and hold the [mode] key 2 seconds or more. The MCF enters parameter setup mode.

Example of parameter display

CF.

Sample display during setup

1.000

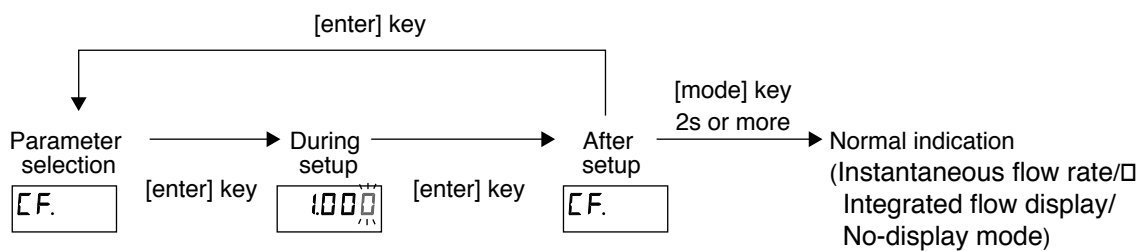

- Move to the desired parameter by pushing [∧] or [∨], and then press [enter].
>> The current setting is indicated with the rightmost digit blinking.
- Push the [mode] key, and the left digit will blink.

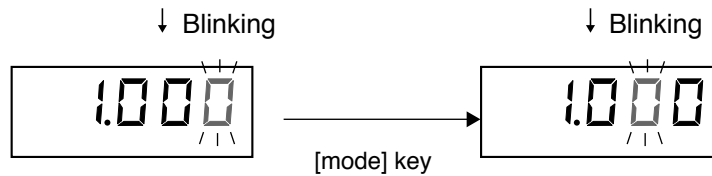

- Use the [∧] or [∨] keys to increase or decrease the numeric value of the blinking digit. Set the desired numerical value for each digit.
- When the desired value is set, press the [enter] key.
>> The setting is changed.
- Repeat steps (2) to (5) if you want to continue setup.
- To exit setup, while the parameter is displayed press and hold the [mode] key 2 seconds or more. The MCF returns to normal indication mode.

Note. If there is no key operation for 30 seconds or more, processing stops and the display turns off. Since the mode will revert to the normal indication mode when the display turns on again, as necessary, return to step (1) to begin the interrupted setup again.

● Parameter settings

Item	Name	Setting range	Factory setting	Description
<i>E1.SP</i>	Event 1 instantaneous flow rate *1	0 to 400 % FS equiv. *4	0	<ul style="list-style-type: none"> • Setup is enabled when function setup <i>Ƙ03</i> is set to <i>01</i> to <i>05</i>. • The decimal point is not shown in the setting range. Depending on the model number the decimal point is added to the display. • If the flow rate units are changed in function setup <i>Ƙ02</i>, set <i>E1.dLY</i> again.
<i>E1.HYS</i>	Hysteresis for event 1 *1	0 to 10 % FS (at 1% interval)	1	
<i>E1.dLY</i>	ON delay for event 1 *2	0 to 60 s (at 1 s interval)	0	
<i>E2.SP</i>	Event 2 instantaneous flow rate *1	0 to 400 % FS equiv. *4	0	<ul style="list-style-type: none"> • Setup is enabled when function setup <i>Ƙ03</i> is set to <i>03</i> or <i>05</i>. • The decimal point is not shown in the setting range. Depending on the model number the decimal point is added to the display. • If the flow rate units are changed in function setup <i>Ƙ02</i>, set <i>E2.dLY</i> again.
<i>E2.HYS</i>	Hysteresis for event 2 *1	0 to 10 % FS (at 1% interval)	1	
<i>E2.dLY</i>	ON delay for event 2 *2	0 to 60 s (at 1 s interval)	0	
<i>CF</i>	Output correction factor	0.100 to 2.000	1.000	Settable in increments of 0.001. This setting affects both indication and output. If it is changed, the peak value and lowest value for instantaneous flow rate are cleared.
<i>LFCvt</i>	Low flow cutoff	1 to 50 % FS (at 1% interval)	1	
<i>E1.Lo</i>	Last 5 digits of integrated flow (event setup)	00000 to 99990	0	Settable when function setup <i>Ƙ03</i> is set to <i>07</i> to <i>10</i> .
<i>E1.Hi</i>	First 4 digits of integrated flow (event setup)	0000 to 9999	0	
<i>Ƙ05t</i>	Flow rate cost multiplier *3	1.0 to 100.0	100.0	This setting is used to indicate cost in the device information display.

*1: Event output for instantaneous flow rate
Behavior depends on the setting in function setup *Ƙ03*.

(1) When *Ƙ03* is set to *01* or *04* (instantaneous flow rate upper limit)

If the flow rate exceeds the instantaneous flow rate upper limit, event output turns on. The point at which event output turns off involves a hysteresis and is calculated as follows:

Event OFF point = instantaneous flow rate upper limit - hysteresis
Specify the hysteresis as a percentage of the full scale flow rate (% FS).

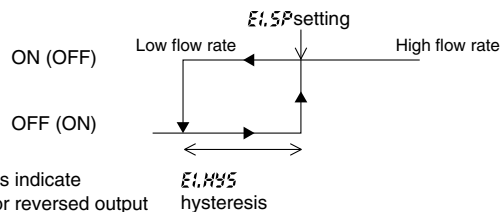

Note: If the Event OFF point is less than zero, the output turns off at zero.

(2) When $\mathcal{L}03$ is set to 02 or 05 (instantaneous flow rate lower limit)

If the flow rate falls below the instantaneous flow rate lower limit, event output turns on. The point at which event output turns off involves a hysteresis and is calculated as follows:

Event OFF point = instantaneous flow rate lower limit + hysteresis
Specify the hysteresis as a percentage of the full scale flow rate (% FS).

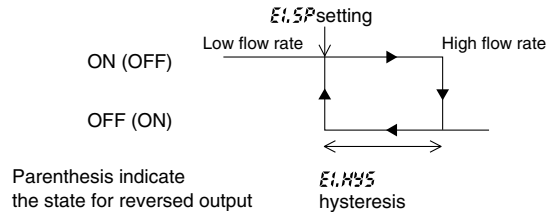

(3) When $\mathcal{L}03$ is set to 03 or 05 (within range for instantaneous flow rate)

When $E1.SP > E2.SP$, the setting for $E1.SP$ is used as the upper limit and the setting for $E2.SP$ is used as the lower limit. When $E1.SP < E2.SP$, the $E1.SP$ setting is the lower limit and $E2.SP$ setting is the upper limit.

When $E1.SP = E2.SP$, this function does not operate.

Hysteresis should be set below the lower limit and above the upper limit. Specify hysteresis as a percentage of full scale flow rate (% FS). Different hysteresis can be set for the lower limit and the upper limit.

• $E1.SP$ setting < $E2.SP$ setting

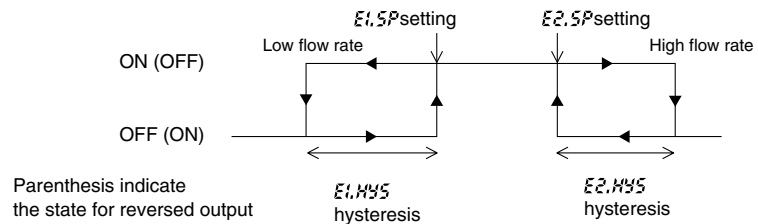

• $E1.SP$ setting > $E2.SP$ setting

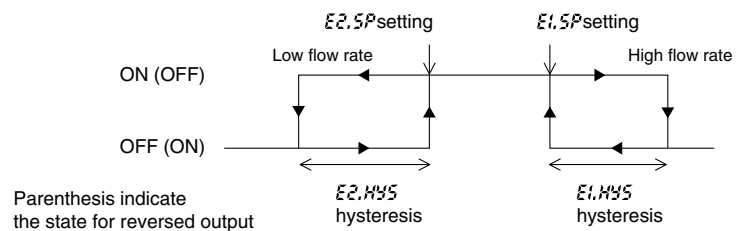

Note: If Event OFF point is less than zero, the output turns off at zero.

*2: Event ON delay

The event ON delay sets a delay before the event output turns on. $E1.dLY$ is for the setup of $E1.SP$ and $E2.dLY$ is for the setup of $E2.SP$.

*3: Flow rate cost calculation

The flow rate cost calculation is related to the setting for flow rate units in function setup $\mathcal{L}02$.

$\mathcal{L}02$ setting	Unit of flow rate cost calculation
00: L/min, L	Per 1m ³
01: m ³ /h, m ³	
02: m ³ /min, m ³	
03: kg/h, kg	Per 1kg

*4: Setting range

The setting range depends on the model number and the flow rate indication units. See the table below.

CO ₂ setting	MCF0080	MCF0150	MCF0151	MCF0250	MCF0400	MCF0500	Notes
00: [L/min]	0 to 480	0 to 1200	0 to 2400	0 to 7200	0 to 14400	0 to 28800	The upper limit of the range corresponds to a flow rate of 240 %FS.
01: [m ³ /h]	0 to 28.8	0 to 72.0	0 to 144.0	0 to 432.0	0 to 864.0	0 to 1728.0	
02: [m ³ /min]	0 to 0.480	0 to 1.200	0 to 2.400	0 to 7.200	0 to 14.400	0 to 28.800	
03: [kg/h]	0 to 37.2	0 to 93.1	0 to 186.2	0 to 558.0	0 to 1117.0	0 to 2234.0	

If the setting exceeds the upper limit for indication, the instantaneous flow rate output will be equivalent to the upper limit for indication.

Do not set values for Event 1 instantaneous flow rate or Event 2 instantaneous flow rate that exceed the upper limit for indication. The instantaneous flow rate may not reach the set value, so that the event does not operate.

■ Device information display

● Viewing the display

- (1) Press and hold the [enter] key for 2 seconds or more while the instantaneous flow rate or integrated flow is indicated on the display.
 >> The MCF moves to the device information display mode, and indicates the item and the related information alternately.
- (2) To move to the next item, push [^]. To return to the previous item, push [v].
- (3) To quit the device information display mode, push the [mode] key.
 >> The MCF returns to normal indication mode.

● Device information

Item	Name	Description
<i>bAtL</i>	Battery level	Indicates the battery level. " o o o ": Full charge " o o ": Good " o ": Low " - ": Critical
<i>Id_01</i>	Model number ID	Used for model identification. MCF0080 →0 MCF0150 →1 MCF0151 →5 MCF0250 →2 MCF0400 →3 MCF0500 →4
<i>Id_02</i>	Range ID	Used to identify standard ranges MCF0080 →2000 (200.0L/min) MCF0150 →5000 (500.0L/min) MCF0151 →10000 (1000.0L/min) MCF0250 →3000 (3000L/min) MCF0400 →6000 (6000L/min) MCF0500 →12000 (12000L/min)
<i>Id_03</i>	Firmware version	
<i>Cost.L</i>	Cost (last digits)	Displays the cost, calculated from the integrated flow value. *1
<i>Cost.H</i>	Cost (first digits)	
<i>Itot.L</i>	Total integrated flow (last digits)	Displays the integrated flow value since the time of shipping. Even if the integrated value is reset, this value will not return to 0.
<i>Itot.H</i>	Total integrated flow (first digits)	
<i>IPrE.L</i>	Integrated flow before resetting (last digits)	The integrated flow before it was reset.
<i>IPrE.H</i>	Integrated flow before resetting (first digits)	

*1: The conversion factor can be changed by changing the cost rate (*Cost*) setting in the parameter setup.
 In the case of integrated flow countdown, the cost is not indicated.

■ Other indications

● Instantaneous flow rate peak value

- (1) Press and hold [\wedge] for 2 seconds or more in the normal indication mode.
 - >> The MCF moves to instantaneous flow rate peak value display mode, and indicates “*FLoHi*” and the peak value alternately.
 - (2) To quit instantaneous flow rate peak value display mode, push the [mode] key.
 - >> The MCF returns to normal indication mode.
- To clear the instantaneous flow rate peak value, press and hold [\wedge] for 5 seconds or more while the peak value is displayed.

● Instantaneous flow rate lowest value

- (1) Press and hold [\vee] for 2 seconds or more in the normal indication mode.
 - >> The MCF moves to instantaneous flow rate lowest value display mode, and indicates “*FLoLo*” and the lowest value alternately.
 - (2) To quit instantaneous flow rate lowest value display mode, push the [mode] key.
 - >> The MCF returns to normal indication mode.
- To clear the instantaneous flow rate lowest value, push and hold [\vee] for 5 seconds or more while the lowest value is displayed.

■ Resetting integrated data

To reset integrated data, press and hold [\wedge] and [\vee] at the same time for 5 seconds or more while the first or last part of the integrated flow amount is indicated on the display.

The integrated flow is reset to zero, unless integrated flow countdown has been selected. In that case, the integrated flow is reset to the amount set in the integrated flow event setup (*Ei.Hi* and *Ei.Lo*).

■ Maintenance mode

The MCF has a special maintenance mode for transferring adjusted values before swapping the measurement module, adjusting the output circuit, etc.

● Changing the Maintenance mode settings

- (1) Press and hold the [mode] key for 2 seconds or more in the normal indication mode. Then press and hold the [mode] key and [\wedge] key at the same time for 2 seconds.
- (2) Move to the desired setup item with the [\vee] or [\wedge] key, and then press [enter].
 - >> The current setting is shown with the rightmost digit blinking.
- (3) If the [mode] key is pressed, the left digit blinks.

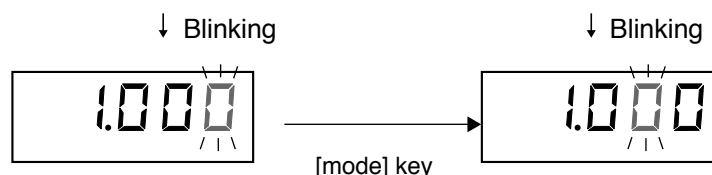

- (4) Press [\wedge] or [\vee] to increase or decrease the numeric value of the blinking digit. Set the desired numerical value for each digit.
- (5) Press the [enter] key.
- (6) Repeat the steps (2) to (5) if you want to continue setup.
- (7) To exit setup, press and hold the [mode] key 2 for seconds or more while the setup item is displayed. The MCF returns to normal indication mode.

● Parameter settings

Item	Name	Setting range setting	Factory	Description
<i>Flt</i>	Calculation filter	1 to 32	8	If the value is large, the response is slow, but also there is less display fluctuation. If the value is small, the response is fast, but there is more display fluctuation. Response times (until the value reaches 95 % of the final value in response to a 0?100 % FS step input) are about 30, 15, and 7 seconds for calculation filters 8, 4, and 2, respectively.
<i>dCt_1</i>	Instantaneous flow rate display resolution in increments of 1	0: normal resolution 1: resolution in increments of 1	0	
<i>PSCF1</i>	Pressure correction adjustment *1	Correction factor	0.995	If <i>C1</i> is selected for pressure correction in <i>C10</i>
<i>PSCF2</i>	Pressure correction adjustment *1	Correction factor	1.005	If <i>C2</i> is selected for pressure correction in <i>C10</i>
<i>oP_0</i>	Flow path identifier 0 *2	Correction factor	*****	Can be set for a spare measurement module.
<i>oP_1</i>	Flow path identifier 1 *2	Correction factor	*****	Registers the inherent flow characteristics of the main flow path. Not available on the MCF0080, MCF0150 and MCF0151.
<i>oP_2</i>	Flow path identifier 2 *2	Correction factor	*****	
<i>SYSD1</i>	Model number *2	2=MCF0250 3=MCF0400 4=MCF0500	**	Can be set for a spare measurement module. An incorrect model number will result in wrong measurement. Not available on the MCF0080, MCF0150 and MCF0151.
<i>PCode</i>	Reserved	***	0	Special options

*1: Mounting direction and setting of the pressure correction factor In the case of a horizontal pipe with the display facing to the right or left as seen from the air inlet, the instantaneous flow rate is displayed with a certain amount of error which depends on the pressure used. However, by setting the pressure correction factor and operating pressure in C10, error due to the mounting direction can be reduced. (For details,  refer to "Mounting direction" on page 8.)

Mounting direction and operating pressure		Settings	
Direction of display	Operating pressure	<i>CF</i> setting	Maintenance mode setting
Horizontal pipe with display facing right as seen from the air inlet (Position 2)	0.3MPa	01	Change <i>PSCF 1</i> to 0.997
	0.1MPa	01	Change <i>PSCF 1</i> to 0.997
	0.5MPa	01	Change <i>PSCF 2</i> to 0.995
	0.7MPa	01	Change <i>PSCF 3</i> to 0.993
Horizontal pipe with display facing left as seen from the air inlet (Position 3)	0.3MPa	02	Change <i>PSCF 1</i> to 1.003
	0.1MPa	02	Change <i>PSCF 1</i> to 1.001
	0.5MPa	02	Change <i>PSCF 2</i> to 1.005
	0.7MPa	02	Change <i>PSCF 3</i> to 1.007

Note. It is not necessary to change the pressure correction factor if the mounting direction is not position 2 or 3. If the factor has been changed by mistake, change it back to the factory setting shown in the Maintenance mode settings table.

Also, if the pressure is less than 0.5 MPa, the amount of correction will be very small. Therefore, the change may not be visible on the display of a small diameter model because it is too small for the display resolution.

*2: Input the model number and identifier of the replacement measurement module using the following procedure:

(1) For *5450 f*, select the model number appropriate for the pipe size of the main path.

Model number	Pipe size	<i>5450 f</i> setting
MCF0250	1B	2
MCF0400	1 1/2B	3
MCF0500	2B	4

(2) Check the number (15 digits) shown on the label on the main flow path and register the numbers for flow path identifiers 0 to 2. Or, before making the replacement, record in advance the settings for flow path identifiers 0 to 2 on the previous measurement module, and register them for the new replacement measurement module.

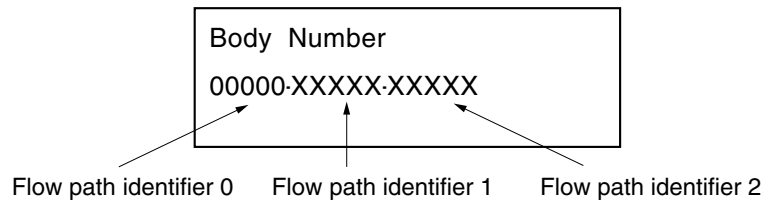

Note: Registering the wrong numbers for model number and flow path identifier may result in incorrect display of the flow rate.

Chapter 6. MAINTENANCE AND TROUBLESHOOTING

⚠ CAUTION



When carrying the flowmeter or connecting it to the pipe, do not hold it by the measurement module. Doing so could cause damage, or the device could drop, causing an injury.



When maintaining or replacing the measurement module, release the internal pressure of this device before removing the measurement module.

■ Maintenance

Be sure to confirm that the MCF is operating normally by inspecting it periodically once or more per year. The MCF has a self-diagnosis function. If an alarm code does not disappear after taking countermeasures, contact the azbil Group or your dealer. Repair or replacement might be necessary.

● Measurement module parts

- Side view of measurement module

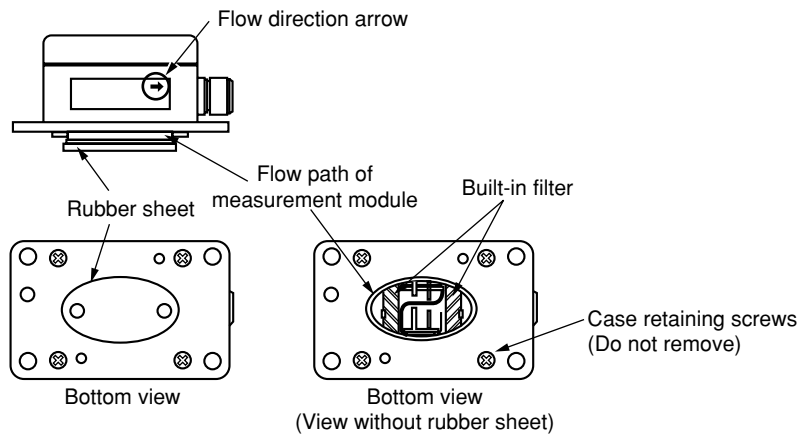

- View without measurement module

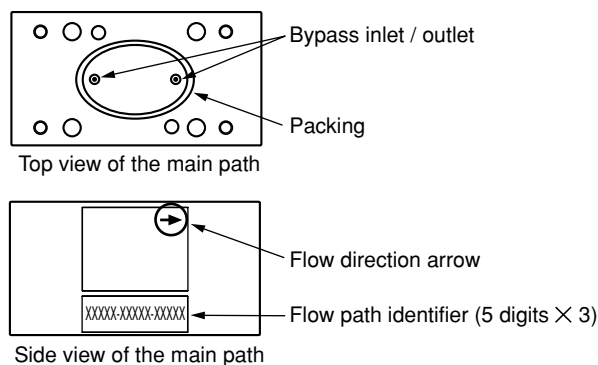

● Maintaining the measurement module

Required items: Allen wrench (M5), Air blower, protective goggles, helmet, gloves.



Handling Precautions

- For your safety, wear goggles while taking the measurement module off.

- (1) Release the air pressure from the MCF and pipes, and then make sure that the gauge pressure is zero.
- (2) Take the four bolts off by loosening them bit by bit in a diagonal pattern.

! Handling Precautions

- Do not clean the measurement module path (bypass path) directly with a blower or the like. Doing so can damage the sensor by blowing foreign matter into it.
- (3) After detaching the measurement module from the MCF, clean the surface above the main path and the bypass inlet/outlet to the measurement module with a blower. At this point, the rubber sheet and the built-in filter might still be affixed to the main path. Before cleaning, take them off. After cleaning, reattach the rubber sheet and filter to the main path. Also, remove the packing and clean it.
 - (4) Make sure that the parts of measurement module are assembled correctly and that the packing is in place in the main path, and then attach the measurement module to the main path with the four bolts, matching the direction of the arrows. Tighten the bolts evenly to the specified torque (2.6 to 3.3 N·m).
 - (5) After attaching the measurement module, connect the connector from the battery box, and check that the displayed instantaneous flow rate is zero.
 - (6) Supplying air pressure to the flowmeter and inside of the pipe, make sure that the instantaneous flow rate shows zero when there is no flow.
 - (7) Be sure that the air does not leak.

! Handling Precautions

- The measurement accuracy is $\pm 5\%$ FS ± 1 digit after the measurement module is reattached.

● Replacing the measurement module on the MCF0250, MCF0400 and MCF0500

- (1) The same as steps 1–3 in ● Maintaining the measurement module.
- (2) Make sure that the parts of new measurement module are assembled correctly and that the packing is in place in the main path, and then attach the measurement module to the main path with the four bolts, matching the direction of the arrows. Tighten the bolts evenly to the specified torque (2.6 to 3.3 N·m).
- (3) After attaching the measurement module, connect the connector from the battery box, and input the flow path identifier.
- (4) Be sure that the instantaneous flow rate shows zero.
- (5) Supplying air pressure to the flowmeter and inside of the pipe, make sure that the instantaneous flow rate shows zero when there is no flow.
- (6) Be sure that the air does not leak.

- (7) After replacement, enter the replacement date in the space marked “Date” at the bottom of the unit change label, and attach the label to the MCF.

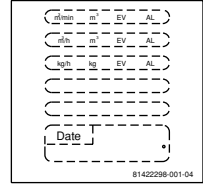

! Handling Precautions

- The measurement accuracy is $\pm 5\%$ FS ± 1 digit after the measurement module is replaced with a new one.
- When replacing an RS-485 communications model or a 4 to 20 mA output model with a battery model, or vice versa, make sure that there are no wiring errors before turning on the MCF.

📖 Note

- Flow path identifier.

The flow path identifier is a property of the main path. It refers to the diversion ratio adjustment of the main path. The flow path identifiers 0 to 2 correspond to diversion ratio adjustments 0 to 2. If the flow path identifier is registered in the measurement module in maintenance mode, the MCF can adjust the output for the properties of the main path. Therefore the MCF is able to maintain accuracy.

● Maintenance of battery box

- (1) If the MCF will not be used for a long period, store it without the batteries to prevent battery leakage problems.
- (2) Do not replace the batteries when the MCF is wet. Take care to prevent entry of water or dust when replacing the batteries.
- (3) Do not replace the batteries when the MCF is in use.
- (4) If the battery alarm is activated, replace the batteries as soon as possible.
- (5) Check regularly for a battery leak or other problems.
- (6) If the batteries are dead, remove them.
- (7) During battery replacement, the integrated flow value may not accumulate for up to 10 minutes. Similarly, in the case of an integrated countdown, the value will not be counted down during this time.
- (8) After battery replacement, check the battery level on the device information display.
- (9) After replacement of the batteries, make sure that the U bolts or mounting bolts which hold the battery box are not loose. If they are loose, retighten them.

■ **Troubleshooting**

● **Remedy for abnormal phenomena**

Phenomenon	Remedy
The display does not indicate anything.	<ul style="list-style-type: none"> • Check that the batteries are not dead and that the polarity is correct. • Check that the connector is connected correctly.
Shutting the front and back valves of the MCF, etc., the actual flow rate should be zero, but the flow rate display does not indicate zero.	<ul style="list-style-type: none"> • Check for air leaks • Check that wiring is correct. • When the MCF is mounted on a horizontal pipe and the display unit faces the side, zero point drift may be caused by the mounting direction. Set the low flow cutoff to 5 % FS. • If the MCF is mounted where the ambient temperature or the temperature of the measured gas fluctuates widely, the MCF might detect convection inside the pipe as a flow. Try measuring after the temperature stabilizes.
Measurement error has increased and exceeds the accuracy specifications.	<ul style="list-style-type: none"> • Check for air leaks. • Check if foreign matter is stuck on the main path orifices. If so, remove it. • After detaching the measurement module from the main path, check if foreign matter is present or stuck on the bypass inlet/outlet of the main path. If so, blow it off with compressed air. • After detaching the measurement module from the main path, check if the internal filter is stained. If so, clean it. • Check if there is foreign matter such as dust or oil on the pipe or the connection port of the MCF. If there is foreign matter, contact the azbil Group. • Check that the wiring is correct. • Check if the flow fluctuates widely, or if it greatly exceeds the measurable limit. • Check if there is a pulsation source.

● Alarm codes and remedies

Alarm code	Item	Contents	Causes	Remedy
<i>RL40</i>	Flow rate range exceeded	Flow exceeds the upper limit for indication. Or, the flow exceeds the reverse flow rate range.	A forward or reverse flow exceeds the specified range.	Check for excessive flow. If a minus sign is shown on the flow rate display when the alarm occurs, there might be a reverse flow. Correct the factor causing the reverse flow. When the actual flow enters the normal range, the alarm lamp should turn off.
<i>RL51</i>	Registered data error 1	The registered flow path identifiers are incorrect. Flow rate cannot be calculated correctly.	Wrong flow path identifiers setting.	Set the correct flow path identifiers in maintenance mode. If the MCF does not return to normal after the setting is changed, reboot it. If the MCF does not return to normal after being restarted, call for repair.
<i>RL59</i>	Battery replacement alarm	Battery voltage is low. (Alarm detection takes at most 10 minutes in standby mode.)	Voltage supplied to the flowmeter is dropping due to a low battery voltage.	Replace the batteries. (Measurement continues even if the alarm is activated.)
<i>RL81</i>	Sensor error 1	The flow signal is outside the normal range.	The flow signal can decrease greatly if foreign matter causes a short circuit or if there is an excessive reverse flow.	If the cause of this alarm is excessive reverse flow, the MCF will return to normal automatically when the flow falls within the measurable range. If the alarm does not turn off in spite of a normal reverse flow, ask for repair.
<i>RL82</i>	Sensor error 2	The flow signal may differ from the actual flow.	The sensor might be broken or the output level might have decreased. Foreign matter or condensation may be present on the sensor.	If the MCF does not return to normal after a few hours of dry air flow, call for repair.
<i>RL91</i>	Memory error	Device data error	Data might be corrupted by electrical noise.	If the MCF does not return to normal after the power is turned off and on again, contact the azbil Group.
<i>RL92</i>		Property error		
<i>RL93</i>		Setup data error	EEPROM write process might have ended abnormally due to power outage.	After trying data setup again and turning the power off and on, if the alarm does not turn off, contact the azbil Group.
<i>RL94</i>		Integrated data error		After resetting the integrated flow and turning the power off and on, if the alarm does not turn off, contact the azbil Group.

Chapter 7. SPECIFICATIONS

■ General specifications

Characteristics in this table are under the standard conditions shown below, unless otherwise specified.

- Operating environment: Standard (see page 41)
- Measured gas: Air
- Pressure: 0.3 ±0.025 MPa
- Flow rate value: Converted to 0 °C, 101.325 kPa (abs)
- Settings: Factory defaults
- Warm-up time: 30 minutes after power on

Item	MCF0080	MCF0150	MCF0151	MCF0250	MCF0400	MCF0500	
Measured gas	Air, N2. Gas must be dry and not contain corrosive components such as chlorine, sulfur and acid. Gas must be a clean, without dust or oil mist.						
Full scale (FS) flow rate [L/min] *	200	500	1000	3000	6000	12000	
Accuracy assurance range [L/min]	4 to 200	10 to 500	20 to 1000	60 to 3000	120 to 6000	240 to 12000	
Minimum sensitivity [L/min]	2	5	10	30	60	120	
Indication resolution [L/min] *1	Instantaneous flow rate	1	1	2	5	10	10
	Integrated flow	10	10	10	10	100	100
Maximum display range *6	[L/min]	0 to 240	0 to 600	0 to 1200	0 to 3600	0 to 7200	0 to 14400
	[m³/h]	0 to 14.4	0 to 36.0	0 to 72.0	0 to 216.0	0 to 432.0	0 to 864.0
	[m³/min]	0 to 0.240	0 to 0.600	0 to 1.200	0 to 3.600	0 to 7.200	0 to 14.400
	[kg/h]	0 to 18.6	0 to 46.6	0 to 93.0	0 to 279.0	0 to 558.0	0 to 1117.0
Indication accuracy for instantaneous flow rate	±3 % FS ±1 digit (except 2 % or less of FS flow rate) *4, 5						
Indication repeatability for instantaneous flow rate	±1 % FS ±1 digit (2 to 100 % of FS flow rate)						
Temperature characteristics	±0.15 % FS / °C ±1 digit or less						
Pressure characteristics for instantaneous flow rate	Operating pressure 0 to 1 MPa	-0.25 % FS / 0.1 MPa ±1 digit or less (2 to 40 % of FS flow rate) -0.55 % FS / 0.1 MPa ±1 digit or less (40 to 100 % of FS flow rate)					
	Operating pressure -0.07 to 0 MPa	±0.25 % FS / 0.01 MPa ±1 digit or less (2 to 40 % of FS flow rate) ±0.55 % FS / 0.01 MPa ±1 digit or less (40 to 100 % of FS flow rate)					
Pressure characteristics of instantaneous flow rate for Position 2 mounting *2	Operating pressure 0 to 1 MPa	0.5 % FS / 0.1 MPa ±1 digit or less (5 to 100 % of FS flow rate)					
	Operating pressure -0.07 to 0 MPa	0.5 % FS / 0.01 MPa ±1 digit or less (5 to 100 % of FS flow rate)					
Pressure characteristics of instantaneous flow rate for Position 3 mounting *3	Operating pressure 0 to 1 MPa	-0.5 % FS / 0.1 MPa ±1 digit or less (5 to 100 % of FS flow rate)					
	Operating pressure -0.07 to 0 MPa	-0.5% FS/0.01MPa ±1 digit or less (5 to 100% of FS flow rate)					

*: FS flow rate indicator full scale flow rate.

*1: The indication resolution shows the smallest displayable digit, regardless of the position of the decimal point or the flow rate units.

*2: Horizontal piping with the display facing right as seen from the air inlet.

*3: Horizontal piping with the display facing left as seen from the air inlet.

*4: Measuring accuracy becomes ±5 % FS ±1 digit after the measurement module is reassembled.

*5: The measuring accuracy becomes ±5 % FS ±1 digit after the measurement module is replaced with a new one. (For MCF0250, MCF0400 and MCF0500)

*6: The indication range is 120 % of the maximum display value (default settings). However, if the output correction factor is set at 2 times the maximum value, the range will extend up to 240 %. Also, if a reverse flow is detected, “-0” is indicated regardless of the flow rate.

Item	MCF0080	MCF0150	MCF0151	MCF0250	MCF0400	MCF0500
Operating pressure range *7	-0.07 to +1.0 MPa (gauge pressure)					
Operating temperature range *7	-10 to +60 °C (without freezing)					
Operating humidity range *7	0 to 90 % RH (without condensation)					
Storage temperature range *7	-20 to +70 °C (without freezing)					
Storage humidity range *7	0 to 90 % RH (without condensation)					
Pressure resistance	1.5 MPa (gauge pressure)					
Allowable leakage rate	100 mL/h (at internal pressure of 1.5 MPa)					
Pipe size (Rc or G depending on model)	1/4 inch	1/2 inch	1/2 inch	1 inch	1 1/2 inch	2 inch
Power supply *10	4 AA alkaline batteries					
Measurement cycle *9	1 ±0.1 s1 (normal mode) 10 ±0.1 s (standby mode)					
Response time *9	30 s max. (time until 95 % of final value for response to 0 to 100 % FS step input, with 50 ms measurement cycle and calculation filter 8.) *8					
Event output	NPN open collector: 30 Vdc, 50 mA max Selectable from following functions: • Instantaneous flow rate switch (upper limit, lower limit, within range) • Integrated flow switch (count-up, countdown) • Integrated pulse output (500ms) • Alarm output					
Alarm event	NPN open collector: 30 Vdc, 50 mA max • Alarm output					
Dielectric strength	1 mA or less of leak current when 500 Vac is applied for 1 s between contacts of connector and main flow path or mounting bolts.					
Insulation resistance	50 MΩ or more between contacts of connector and main flow path or mounting bolts, with 500 Vdc megger					
Measurement module mounting bolt tightening torque	2.6 to 3.3 N·m					
Protective structure	IP65 (JISC0920 and IEC529): drip-proof and dust-proof structure, assuming indoor use					
Tightening torque for battery box cover screws	1.3 to 1.6 N·m					
Mass	Approx. 400 g	Approx. 400 g	Approx. 400 g	Approx. 500 g	Approx. 700 g	Approx. 1.1 kg

*7: For battery models, if the operation temperature and humidity ranges for the batteries are more narrow than the ranges for the MCF, the ranges for the battery have priority.

The operation and storage temperature range for the trial-run batteries (included with the MCF) is -10 to +45°C

Example : If batteries with an operating temperature range of -10 to +50 °C are used, the operating temperature range for the MCF is -10 to +50 °C. If batteries with an operating temperature range of -15 to +50 °C are used, the operating temperature range for the MCF is -10 to +50 °C.

*8: The response time delay goes from the calculation filter to the instantaneous flow rate and the integration switch. If faster responses are necessary, change the calculation filter setting.

Example : 11 seconds (time until the value reaches 95 % of the final value in response to a 0 to 100 % FS step input) when the calculation filter is set to 4, and 5 seconds when it is set to 2

Compared to normal mode, standby mode causes a delay of up to 10 seconds.

*9: If no flow or reverse flow continues for 15 seconds or more, the MCF will go into standby mode to reduce power consumption, and the measurement cycle will be automatically switched from the usual 1 s to 10 s. When a normal (forward) flow is detected again, the cycle returns to 1 s. For details, refer to "Standby mode" on page 20.

*10: If the MCF is in standby mode 12 hours a day, the battery life is about 3 years. (The battery replacement alarm will be activated in about 2.5 years.)
 If it is in normal mode (continuous measurement) 24 hours a day, battery life is about 2 years. (The battery replacement alarm will be activated in about 1.6 years.) These reference values are for new batteries whose capacity is equal to that of the included batteries, when they are used at normal temperature.

● **Material and treatments**

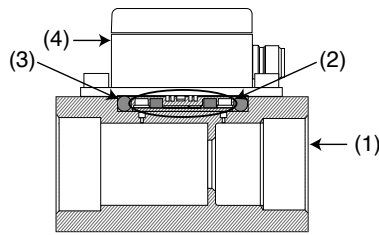

Model number	MCF___A_____
(1) Main flow path	Aluminum alloy (alumite treatment)
(2) Measurement module	SUS304, PBT, HNBR, Urethane foam
(3) Packing	HNBR
(4) Measurement module electronic component case	Modified PPO

Note: The main flow passage of G thread models has no alumite treatment.

■ Environmental conditions

● Standard conditions

Ambient temperature	23 ±3 °C
Ambient humidity	60 ±5 % RH
Rated power supply	6 Vdc
Vibration	0 m/s ²
Shock	0 m/s ²
Mounting direction	Mounting on horizontal pipes with display upward

● Operating conditions (Flowmeter)

Ambient temperature	-10 to +60 °C (without freezing)
Ambient humidity	0 to 90 % RH (without condensation)
Rated power supply	3.6 to 7.2 Vdc
Vibration	0 m/s ²
Shock	0 m/s ²
Mounting direction	Horizontal or vertical

Note: For battery models, if the storage temperature and humidity ranges for the batteries are more narrow than the ranges for the MCF, the ranges for the battery have priority.

Example: If batteries with a storage temperature range of -10 to +50 °C are used, the storage temperature range for the MCF becomes -10 to +50 °C.

If batteries with a storage temperature range of -15 to +50 °C are used, the storage temperature range for the MCF becomes -10 to +50 °C

● Transport/storage conditions (Flowmeter)

Ambient temperature	-20 to +70 °C
Ambient humidity	0 to 90 % RH
Vibration	10 to 500 Hz, with 1.5 mm amplitude or 98 m/s ² acceleration
Shock	490 m/s ²
Package drop	Drop height 60 cm (1 corner, 3 edges and 6 surfaces, free fall)

Note: For battery models, if the storage temperature and humidity ranges for the batteries are more narrow than the ranges for the MCF, the ranges for the battery have priority.

Example: If batteries with a storage temperature range of -10 to +50 °C are used, the storage temperature range for the MCF becomes -10 to +50 °C.

If batteries with a storage temperature range of -15 to +50 °C are used, the storage temperature range for the MCF becomes -10 to +50 °C

■ External dimensions

● MCF0080

Unit : mm

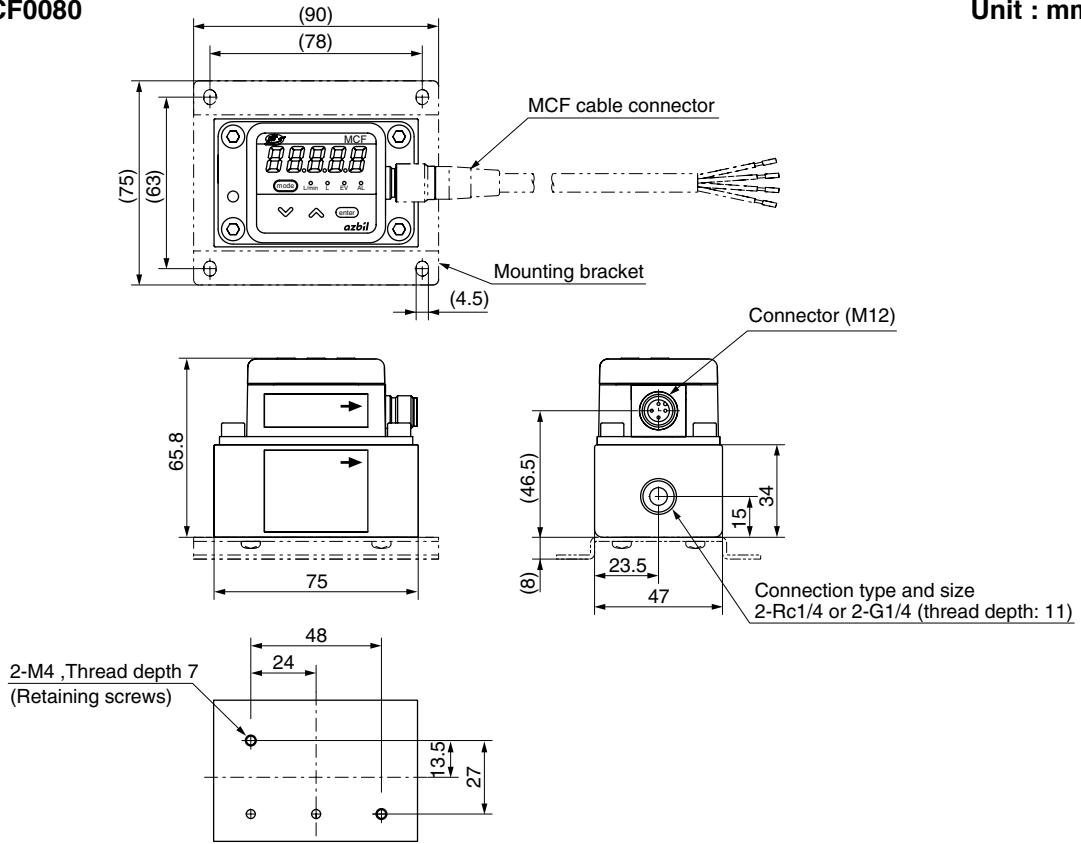

● MCF0150/MCF0151

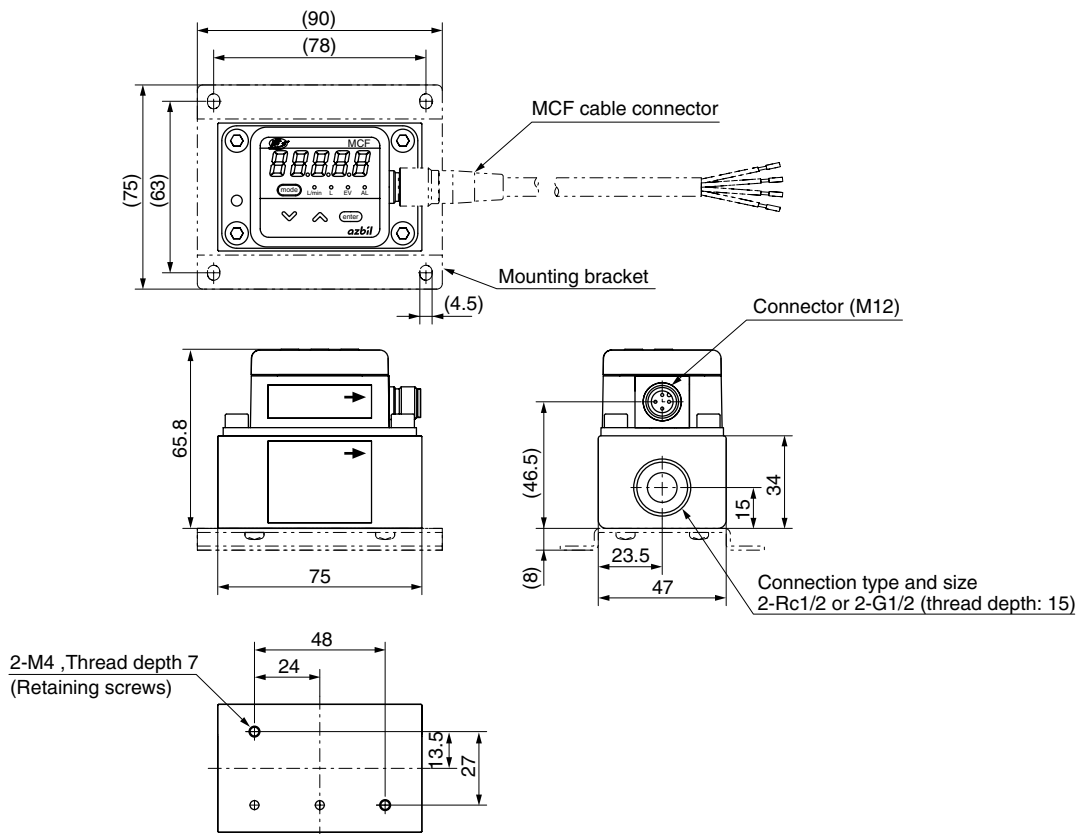

● MCF0250

Unit : mm

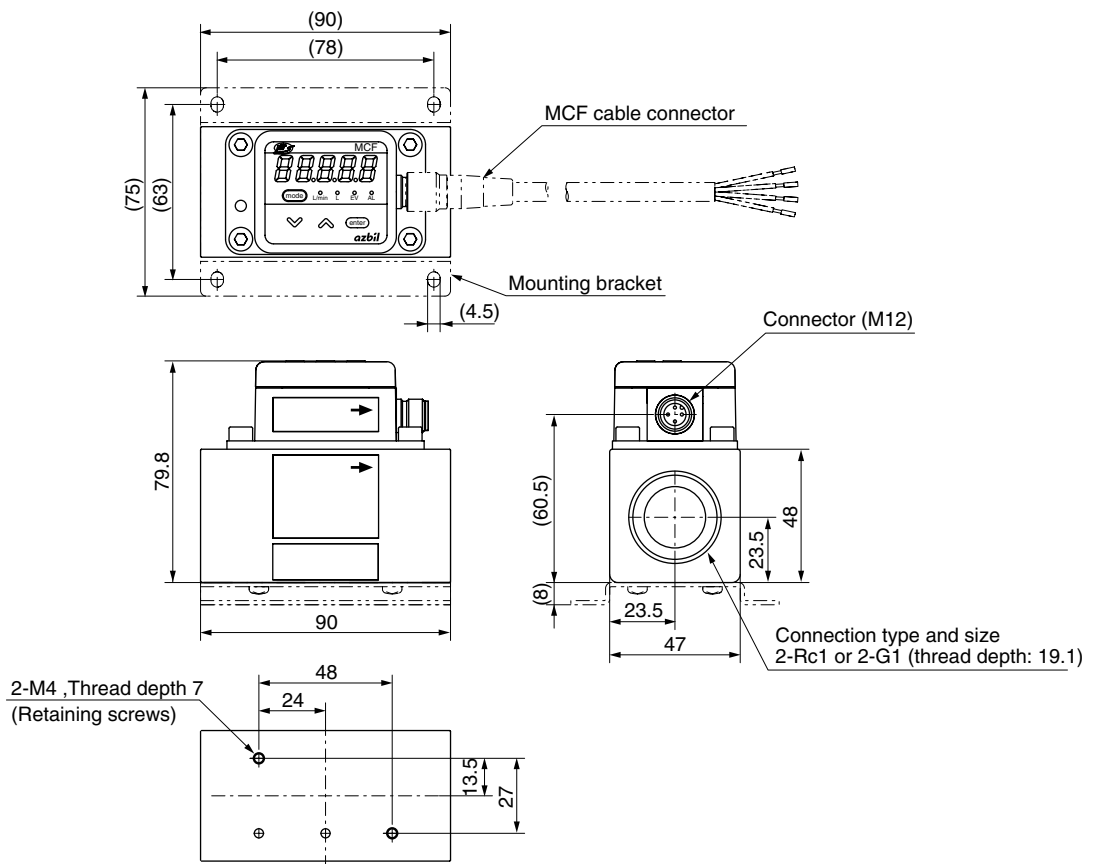

● MCF0400

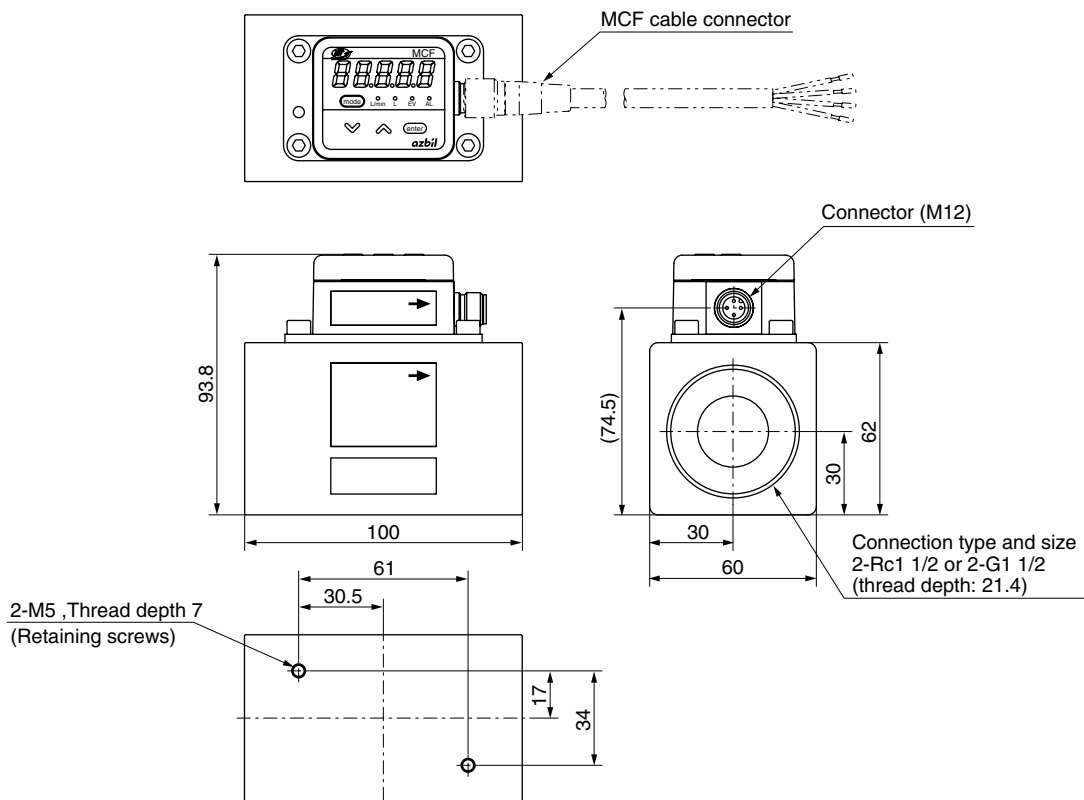

● MCF0500

Unit : mm

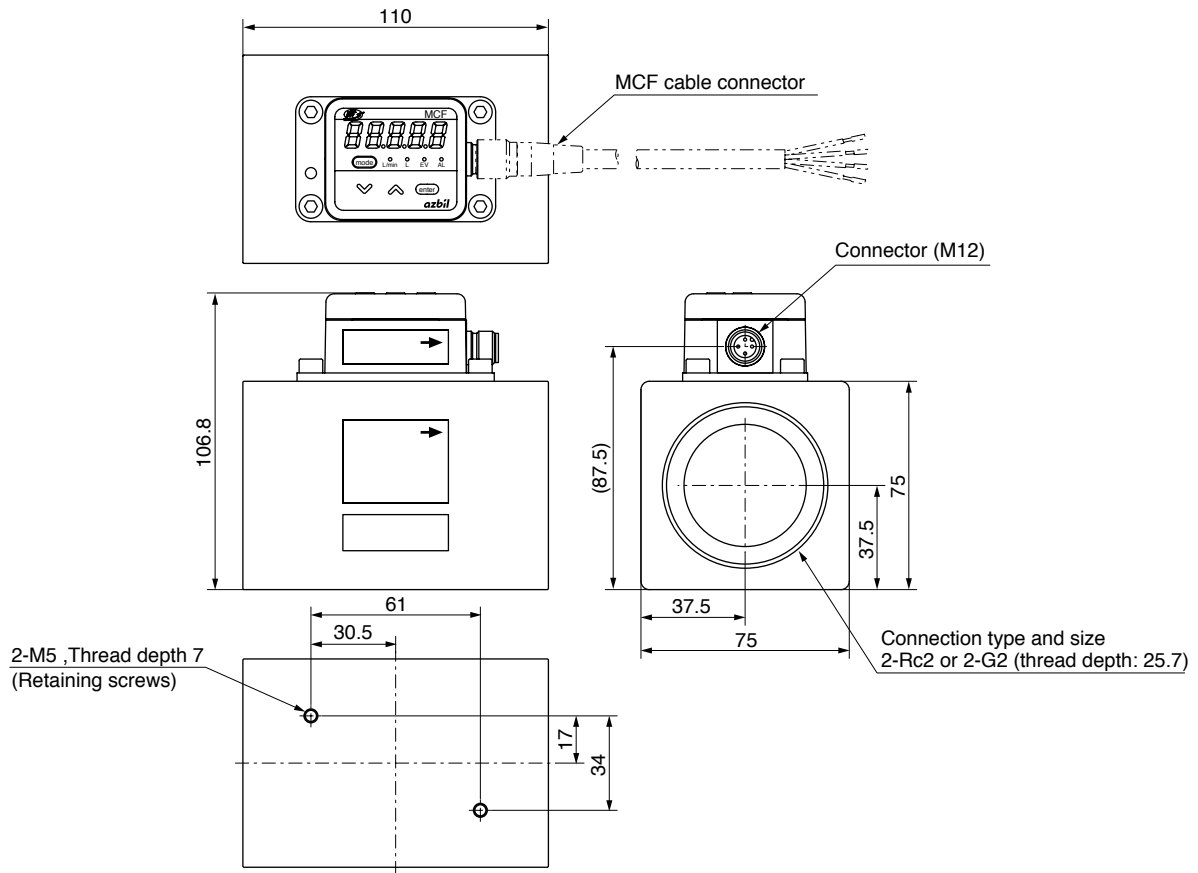

● Battery box

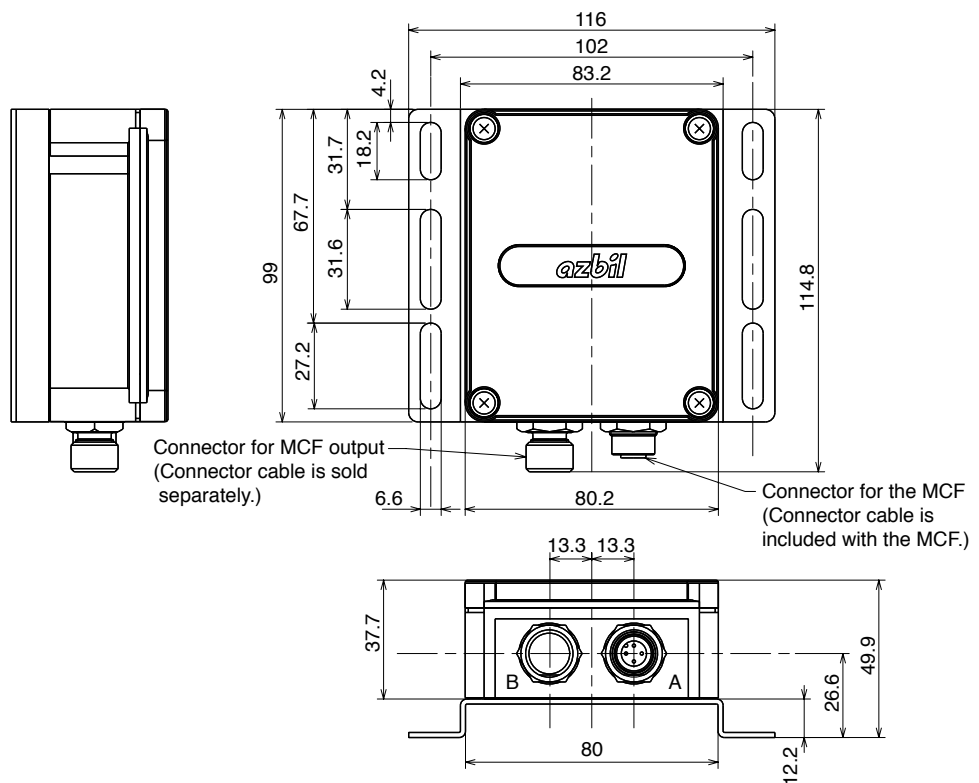

■ **Pressure loss**

Typical characteristics are shown below.

● **MCF0080 (1/4 inch)**

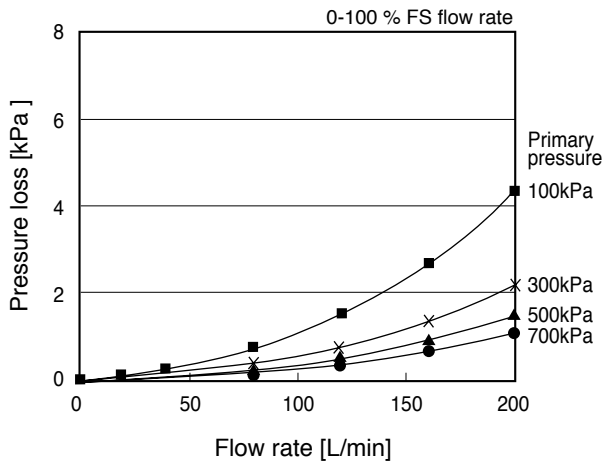

● **MCF0150 (1/2 inch)**

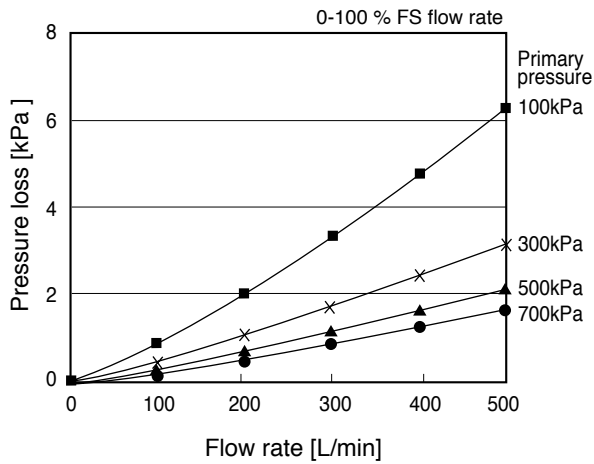

● **MCF0151 (1/2 inch)**

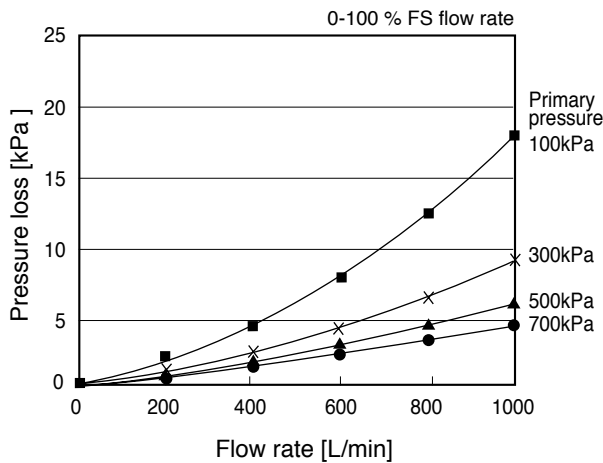

● MCF0250 (1 inch)

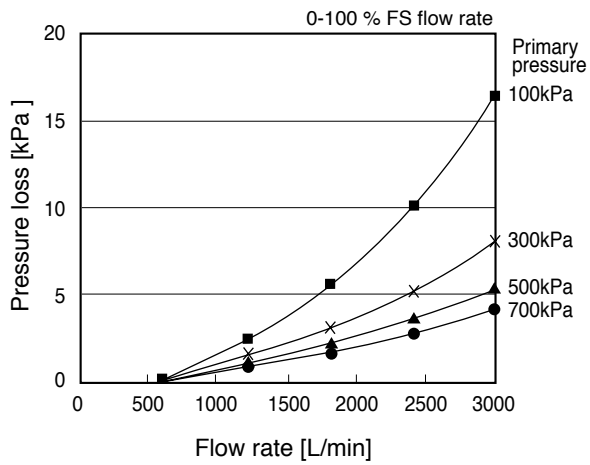

● MCF0400 (1 1/2 inch)

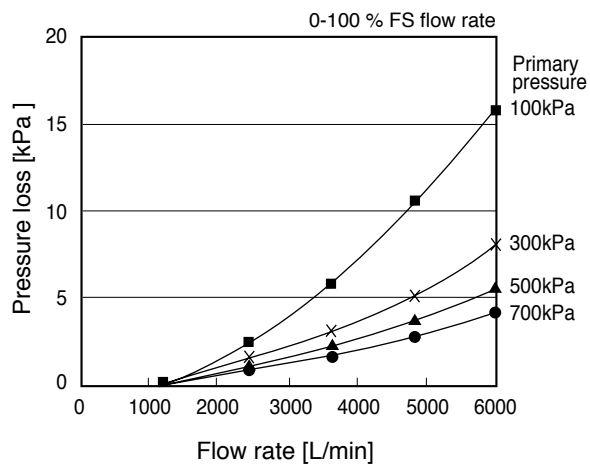

● MCF0500 (2 inch)

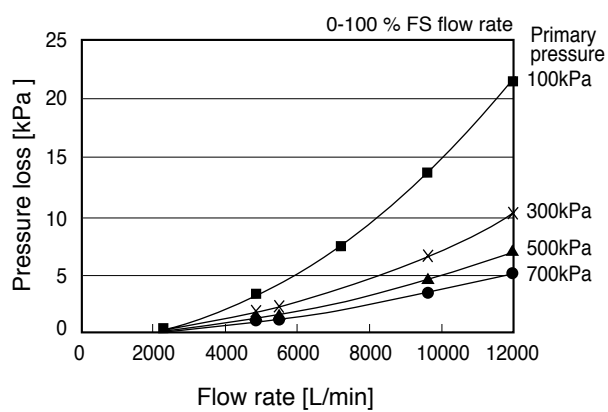

Terms and Conditions

We would like to express our appreciation for your purchase and use of Azbil Corporation's products. You are required to acknowledge and agree upon the following terms and conditions for your purchase of Azbil Corporation's products (field instruments, control valves, and control products), unless otherwise stated in any separate document, including, without limitation, estimation sheets, written agreements, catalogs, specifications and instruction manuals.

1. Warranty period and warranty scope

1.1 Warranty period

Azbil Corporation's products shall be warranted for one (1) year from the date of your purchase of the said products or the delivery of the said products to a place designated by you.

1.2 Warranty scope

In the event that Azbil Corporation's products has any failure attributable to azbil during the aforementioned warranty period, azbil shall, without charge, deliver a replacement for the said product to the place where you purchased, or repair the said product and deliver it to the aforementioned place.

Notwithstanding the foregoing, any failure falling under one of the following shall not be covered under this warranty:

- (1) Failure caused by your improper use of Azbil Corporation's products (noncompliance with conditions, environment of use, precautions, etc. set forth in catalogs, specifications, instruction manuals, etc.);
- (2) Failure caused for other reasons than Azbil Corporation's products;
- (3) Failure caused by any modification or repair made by any person other than azbil or azbil's subcontractors;
- (4) Failure caused by your use of Azbil Corporation's products in a manner not conforming to the intended usage of that product;
- (5) Failure that the state-of-the-art at the time of Azbil Corporation's shipment did not allow us to predict; or
- (6) Failure that arose from any reason not attributable to Azbil Corporation, including, without limitation, acts of God, disasters, and actions taken by a third party.

Please note that the term "warranty" as used herein refers to equipment-only-warranty, and Azbil Corporation shall not be liable for any damages, including direct, indirect, special, incidental or consequential damages in connection with or arising out of Azbil Corporation's products.

2. Ascertainment of suitability

You are required to ascertain the suitability of Azbil Corporation's products in case of your use of the same with your machinery, equipment, etc. (hereinafter referred to as "Equipment") on your own responsibility, taking the following matters into consideration:

- (1) Regulations and standards or laws that your Equipment is to comply with.
- (2) Examples of application described in any documents provided by Azbil Corporation are for your reference purpose only, and you are required to check the functions and safety of your Equipment prior to your use.
- (3) Measures to be taken to secure the required level of the reliability and safety of your Equipment in your use. Although Azbil Corporation is constantly making efforts to improve the quality and reliability of Azbil Corporation's products, there exists a possibility that parts and machinery may break down. You are required to provide your Equipment with fool-proof design, fail-safe design, anti-flame propagation design, safety design, or the like so that the said Equipment may satisfy the level of the reliability and safety required in your use, whereby preventing any occurrence of physical injuries, fires, significant damage, and so forth.

3. Precautions and restrictions on application

Azbil Corporation's products other than those explicitly specified as applicable (e.g. azbil Limit Switch For Nuclear Energy) shall not be used in a nuclear energy controlled area (radiation controlled area). Any Azbil Corporation's products shall not be used for/with medical equipment.

In addition,

you are required to conduct a consultation with our sales representative and understand detail specifications, cautions for operation, and so forth by reference to catalogs, specifications, instruction manual, etc. in case that you intend to use Azbil Corporation's products for any purposes specified in (1) through (6) below.

Moreover, you are required to provide your Equipment with fool-proof design, fail-safe design, anti-flame propagation design and other designs of protection/safety circuit on your own responsibility to ensure the reliability and safety, whereby preventing problems caused by failure or nonconformity.

- (1) For use under such conditions or in such environments as not stated in technical documents, including catalogs, specification, and instruction manuals
- (2) For use of specific purposes, such as:
 - * Nuclear energy/radiation related facilities
[For use outside nuclear energy controlled areas] [For use of Azbil Corporation's Limit Switch For Nuclear Energy]
 - * Machinery or equipment for space/sea bottom
 - * Transportation equipment
[Railway, aircraft, vessels, vehicle equipment, etc.]
 - * Antidisaster/crime-prevention equipment
 - * Burning appliances
 - * Electrothermal equipment
 - * Amusement facilities
- (3) Supply systems such as electricity/gas/water supply systems, large-scale communication systems, and traffic/air traffic control systems requiring high reliability
- (4) Facilities that are to comply with regulations of governmental/public agencies or specific industries
- (5) Machinery or equipment that may affect human lives, human bodies or properties
- (6) Other machinery or equipment equivalent to those set forth in items (1) to (5) above which require high reliability and safety

4. Precautions against long-term use

Use of Azbil Corporation's products, including switches, which contain electronic components, over a prolonged period may degrade insulation or increase contact-resistance and may result in heat generation or any other similar problem causing such product or switch to develop safety hazards such as smoking, ignition, and electrification.

Although acceleration of the above situation varies depending on the conditions or environment of use of the products, you are required not to use any Azbil Corporation's products for a period exceeding ten (10) years unless otherwise stated in specifications or instruction manuals.

5. Recommendation for renewal

Mechanical components, such as relays and switches, used for Azbil Corporation's products will reach the end of their life due to wear by repetitious open/close operations.

In addition, electronic components such as electrolytic capacitors will reach the end of their life due to aged deterioration based on the conditions or environment in which such electronic components are used. Although acceleration of the above situation varies depending on the conditions or environment of use, the number of open/close operations of relays, etc.

as prescribed in specifications or instruction manuals, or depending on the design margin of your machine or equipment, you are required to renew any Azbil Corporation's products every 5 to 10 years unless otherwise specified in specifications or instruction manuals.

Field instruments (sensors such as pressure/flow/level sensors, regulating valves, etc.) will reach the end of their life due to aged deterioration of parts.

For those parts that will reach the end of their life due to aged deterioration, recommended replacement cycles are prescribed. You are required to replace parts based on such recommended replacement cycles.

6. Other precautions

Prior to your use of Azbil Corporation's products, you are required to understand and comply with specifications (e.g., conditions and environment of use), precautions, warnings/cautions/notices as set forth in the technical documents prepared for individual Azbil Corporation's products, such as catalogs, specifications, and instruction manuals to ensure the quality, reliability, and safety of those products.

7. Changes to specifications

Please note that the descriptions contained in any documents provided by Azbil Corporation are subject to change without notice for improvement or for any other reason.

For inquires or information on specifications as you may need to check, please contact our branch offices or sales offices, or your local sales agents.

8. Discontinuance of the supply of products/parts

Please note that the production of any Azbil Corporation's products may be discontinued without notice.

For repairable products, we will, in principle, undertake repairs for five (5) years after the discontinuance of those products. In some cases, however, we cannot undertake such repairs for reasons, such as the absence of repair parts.

For field instruments, we may not be able to undertake parts replacement for similar reasons.

azbil

Azbil Corporation
Advanced Automation Company

1-12-2 Kawana, Fujisawa
Kanagawa 251-8522 Japan

URL: <http://www.azbil.com>

Specifications are subject to change without notice. (09)

1st edition: Dec. 2010 (T)
2nd edition: Apr. 2012 (F)