



## 2- und 3-Wege-Kugelhähne

- Verschiedene Gehäuseausführungen
- Voller Durchgang
- Auch mit DVGW-Zulassung lieferbar

Handkugelhähne aus Messing und Edelstahl zum Absperrern und Verteilen von Medienströmen.

### Ausführungen

- Handabsperr-Kugelhahn, voller Durchgang
- Kugelhahn mit DVGW-Zulassung
- Mini-Lux-Kugelhahn mit Drehflügel
- Kugelhahn mit Drehflügel, voller Durchgang
- 3-Wege-Kugelhahn mit L- oder T-Bohrung
- Edelstahlkugelhahn

### Technische Daten

|                                  |   |           |
|----------------------------------|---|-----------|
| <b>Nennweite</b>                 | DN6 - DN100   |           |
| <b>Gehäusewerkstoff</b>          | Messing, vernickelt   | Edelstahl |
| <b>Kugelwerkstoff</b>            | Messing, hartverchromt  | Edelstahl |
| <b>Dichtwerkstoff</b>            | PTFE  | PTFE      |
| <b>Druckbereich<sup>1)</sup></b> | technisches Vakuum ( $10^{-3}$ Torr)<br>bis Nenndruck PN (siehe Bestell-Tabellen) |           |
| <b>Temperaturbereich</b>         | siehe Bestell-Tabellen  |           |

<sup>1)</sup> Druckangaben [bar]: Überdruck zum Atmosphärendruck

## Bestell-Tabelle 2- und 3-Wege-Kugelhähne, Messing-Gehäuse

Handabsperrr-Kugelhahn, voller Durchgang, Innengewinde, beidseitig

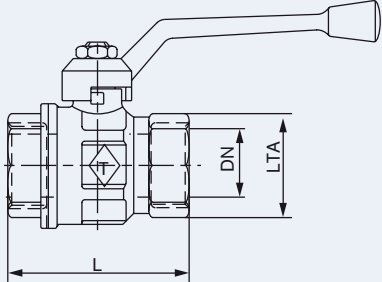
| TKU004  | Werkstoffe                              | Temperaturbereich        | DN [mm] | LTA | L [mm] | K <sub>v</sub> -Wert [m <sup>3</sup> /h] | PN (80 °C) [bar] | Artikel-Nr. |
|---|---|--------------------------|---------|-----|--------|--|------------------|-------------|
|   |   |                          |         |     |        |  |                  |             |
|  | Gehäuse: Messing, vernickelt            | -20 °C<br>bis<br>+160 °C | 8       | ¼   | 51,5   | 5,4                                      | 64               | 780230      |
|   | Kugel: Messing, hartverchromt           |                          | 10      | ¾   | 51,5   | 6,0                                      | 64               | 780231      |
|   | Dichtung: PTFE                          |                          | 15      | ½   | 55,0   | 16,3                                     | 30               | 780232      |
|   | Hebel: Aluminium, kunststoffbeschichtet |                          | 20      | ¾   | 57,0   | 29,5                                     | 30               | 780233      |
|   |   |                          | 25      | 1   | 69,5   | 43,0                                     | 30               | 780234      |
|   |   |                          | 32      | 1¼  | 81,5   | 89                                       | 25               | 781746      |
|   |   |                          | 40      | 1½  | 95     | 230                                      | 25               | 781747      |
|   |   |                          | 50      | 2   | 113    | 265                                      | 25               | 781748      |

Kugelhahn, DVGW-Zulassung (DIN DVGW-NG- 4312BU0103), voller Durchgang

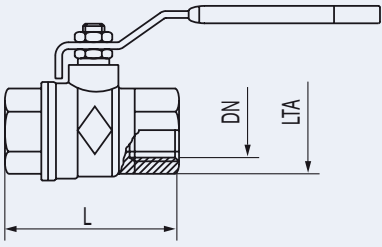
| TKU004  | Werkstoffe                                  | Temperaturbereich       | DN [mm] | LTA | L [mm] | K <sub>v</sub> -Wert [m <sup>3</sup> /h] | PN [bar] | Artikel-Nr. |
|---|---|-------------------------|---------|-----|--------|--|----------|-------------|
|   |   |                         |         |     |        |  |          |             |
|  | Gehäuse: Messing, vernickelt                | -20 °C<br>bis<br>+60 °C | 10      | ¼   | 47,5   | 5,4                                      | 5        | 773239      |
|   | Kugel: Messing, hartverchromt               |                         | 10      | ¾   | 49,5   | 6  | 5        | 773240      |
|   | Dichtung: PTFE                              |                         | 15      | ½   | 65,0   | 16,3                                     | 5        | 773241      |
|   | Hebel: Aluminium, eloxiert, gelbbeschichtet |                         | 20      | ¾   | 73,5   | 29,5                                     | 5        | 773242      |
|   |   |                         | 25      | 1   | 86,5   | 43                                       | 5        | 773243      |
|   |   |                         | 32      | 1¼  | 101,5  | 89                                       | 5        | 773244      |
|   |   |                         | 40      | 1½  | 111,5  | 230                                      | 5        | 773245      |
|   |   |                         | 50      | 2   | 132,5  | 265                                      | 5        | 773246      |

Mini-Lux-Kugelhahn mit Drehflügel, Innengewinde, beidseitig

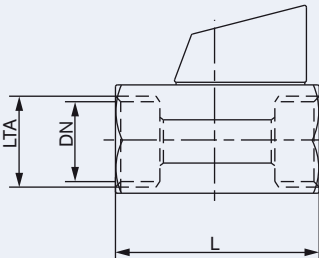
| TKU004  | Werkstoffe                    | Temperaturbereich       | DN [mm] | LTA | L [mm] | K <sub>v</sub> -Wert [m <sup>3</sup> /h] | PN [bar] | Artikel-Nr. |
|---|-------------------------------|-------------------------|---------|-----|--------|--|----------|-------------|
|   |                               |                         |         |     |        |  |          |             |
|  | Gehäuse: Messing, vernickelt  | -20 °C<br>bis<br>+90 °C | 6       | ⅞   | 41     | 4,3                                      | 10       | 781653      |
|   | Kugel: Messing, hartverchromt |                         | 8       | ¼   | 41     | 4,3                                      | 10       | 781654      |
|   | Dichtung: PTFE                |                         | 10      | ¾   | 41     | 4,3                                      | 10       | 781655      |
|   |                               |                         | 15      | ½   | 46     | 4,3                                      | 10       | 781656      |

## Bestell-Tabelle 2- und 3-Wege-Kugelhähne, Messing-Gehäuse, Forts.

## Mini-Lux-Kugelhahn mit Drehflügel, Innen- und Außengewinde

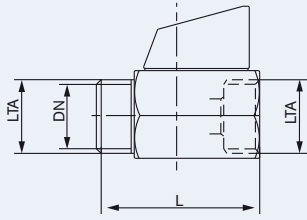
| TKU004  | Werkstoffe  | Temperaturbereich | DN   | LTA | L    | K <sub>v</sub> -Wert | PN    | Artikel-Nr. |
|---|---|-------------------|------|-----|------|----------------------|-------|-------------|
|   |   |                   | [mm] |     | [mm] | [m <sup>3</sup> /h]  | [bar] |             |
|  | Gehäuse: Messing, vernickelt<br>Kugel: Messing, hartverchromt<br>Dichtung: PTFE | -20 °C bis +90 °C | 8    | ⅛   | 41   | 4,3                  | 10    | 781657      |
|   |   |                   | 8    | ¼   | 41   | 4,3                  | 10    | 781658      |
|   |   |                   | 10   | ⅜   | 41   | 2,7                  | 10    | 781659      |
|   |   |                   | 15   | ½   | 46   | 5,4                  | 10    | 781660      |

## Kugelhahn mit Drehflügel, voller Durchgang, Innengewinde, beidseitig

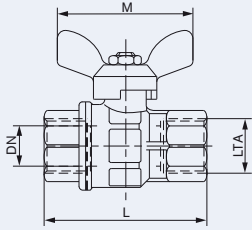



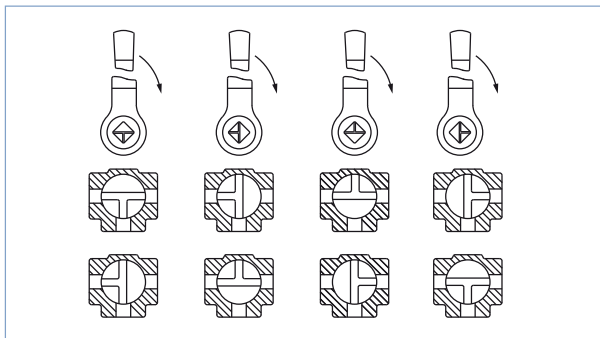
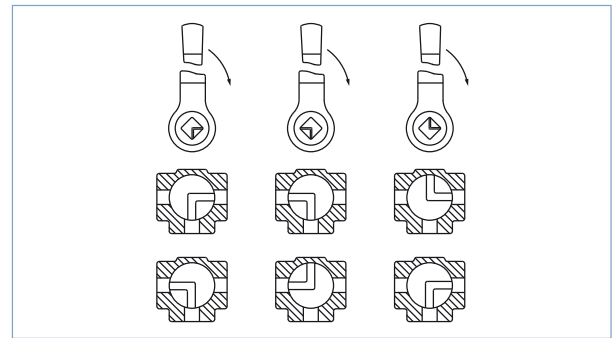

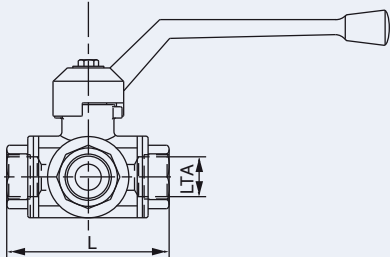

| TKU004  | Werkstoffe  | Temperaturbereich  | DN   | LTA | L    | M    | K <sub>v</sub> -Wert | PN    | Artikel-Nr. |
|---|---|--------------------|------|-----|------|------|----------------------|-------|-------------|
|   |   |                    | [mm] |     | [mm] | [mm] | [m <sup>3</sup> /h]  | [bar] |             |
|  | Gehäuse: Messing, vernickelt<br>Kugel: Messing, hartverchromt<br>Dichtung: PTFE<br>Hebel: Aluminium | -20 °C bis +160 °C | 8    | ¼   | 51,5 | 50   | 5,4                  | 64    | 781752      |
|   |   |                    | 10   | ⅜   | 51,5 | 50   | 6,0                  | 64    | 781753      |
|   |   |                    | 15   | ½   | 55   | 50   | 16,3                 | 30    | 781754      |
|   |   |                    | 20   | ¾   | 57,5 | 64   | 29,5                 | 30    | 781755      |
|   |   |                    | 25   | 1   | 69,5 | 94   | 43                   | 30    | 781756      |

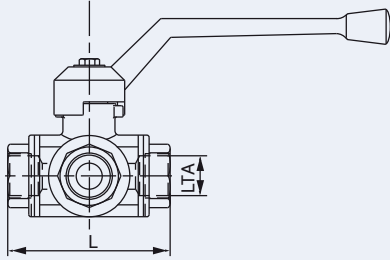
## 3-Wege-Kugelhahn mit L- oder T-Bohrung, voller Durchgang

Schaltstellungen  
T-BohrungenSchaltstellungen  
L-Bohrungen

| TKU004  | Werkstoffe  | Temperaturbereich  | DN   | LTA | L      | K <sub>v</sub> -Wert | PN    | Artikel-Nr.<br>L-Bohrung |
|---|---|--------------------|------|-----|--------|----------------------|-------|--------------------------|
|   |   |                    | [mm] |     | [mm]   | [m <sup>3</sup> /h]  | [bar] |                          |
|  | Gehäuse: Messing, vernickelt<br>Kugel: Messing, hartverchromt<br>Dichtung: PTFE<br>Hebel: Aluminium | -20 °C bis +160 °C | 8    | ¼"  | 80,5   | 2,8                  | 40    | 781762                   |
|   |   |                    | 10   | ⅜"  | 80,5   | 3                    | 40    | 781763                   |
|   |   |                    | 15   | ½"  | 80,5   | 3,6                  | 40    | 781764                   |
|   |   |                    | 20   | ¾"  | 93,4   | 6                    | 40    | 781765                   |
|   |   |                    | 25   | 1"  | 107,3  | 11                   | 25    | 781766                   |
|   |   |                    | 32   | 1¼" | 118    | 16                   | 16    | 781767                   |
|   |   |                    | 40   | 1½" | 141    | 25,5                 | 16    | 781768                   |
| 50  | 2"  | 169                | 37,5 | 16  | 781769 |                      |       |                          |

## Bestell-Tabelle 2- und 3-Wege-Kugelhähne, Messing-Gehäuse, Forts.

| TKU004<br>                   | Werkstoffe               | Temperaturbereich | DN   | LTA   | L    | K <sub>v</sub> -Wert | PN   | Artikel-Nr.<br>T-Bohrung |
|---|--------------------------|-------------------|------|-------|------|----------------------|--|--------------------------|
|   |                          |                   | [mm] |       | [mm] | [m <sup>3</sup> /h]  | [bar]  |                          |
| Gehäuse:<br>Messing vernickelt<br>Kugel:<br>Messing<br>hartverchromt<br>Dichtung: PTFE<br>Hebel:<br>Aluminium | -20 °C<br>bis<br>+160 °C | 8                 | ¼"   | 80,5  | 3    | 40                   | 781770  |                          |
|   |                          | 10                | ⅜"   | 80,5  | 3,5  | 40                   | 781771  |                          |
|   |                          | 15                | ½"   | 80,5  | 4,3  | 40                   | 781772  |                          |
|   |                          | 20                | ¾"   | 93,4  | 6,6  | 40                   | 781773  |                          |
|   |                          | 25                | 1"   | 107,3 | 12,2 | 25                   | 781774  |                          |
|   |                          | 32                | 1¼"  | 118   | 16,9 | 16                   | 781775  |                          |
|   |                          | 40                | 1½"  | 141   | 26,3 | 16                   | 781776  |                          |
|   |                          | 50                | 2"   | 169   | 38,2 | 16                   | 781777  |                          |

Bestell-Tabelle 2- und 3-Wege-Kugelhähne, Edelstahl-Gehäuse

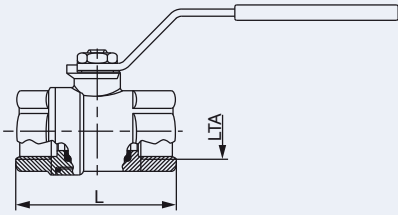
| TKU004  | Werkstoffe                              | Temperaturbereich        | DN [mm] | LTA | L [mm] | K <sub>v</sub> -Wert [m <sup>3</sup> /h] | PN (80 °C) [bar] | Artikel-Nr. |
|---|---|--------------------------|---------|-----|--------|--|------------------|-------------|
|   |   |                          |         |     |        |  |                  |             |
|  | Gehäuse:<br>Edelstahl<br>AISI 351-CF 8M | -20 °C<br>bis<br>+160 °C | 8       | ¼"  | 53,5   | 5,4                                      | 64               | 781824      |
|   | Kugel:<br>Edelstahl AISI 351            |                          | 10      | ⅜"  | 53,5   | 6  | 64               | 781825      |
|   |   |                          | 15      | ½"  | 60     | 16,3                                     | 64               | 781826      |
|   | Dichtung: PTFE                          |                          | 20      | ¾"  | 70     | 29,5                                     | 40               | 781827      |
|   | O-Ring: FKM                             |                          | 25      | 1"  | 79     | 43                                       | 40               | 781828      |
|   | Hebel: Edelstahl<br>AISI 430            |                          | 32      | 1¼" | 91     | 89                                       | 25               | 781829      |
|   |   |                          | 40      | 1½" | 103    | 230                                      | 25               | 781830      |
|   |   |                          | 50      | 2"  | 124    | 265                                      | 25               | 781831      |

3-Wege-Kugelhahn mit L- oder T-Bohrung, reduzierter Durchgang mit Montageflansch, ISO 5211 und Handhebel

Schaltstellungen  
T-Bohrungen

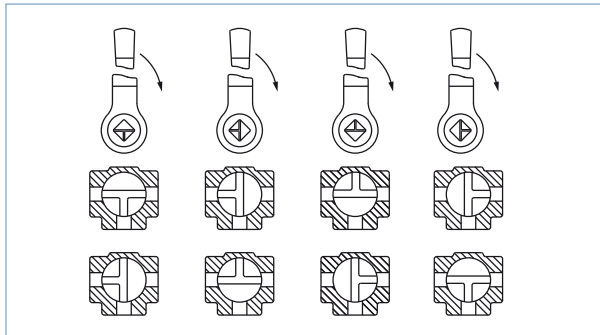



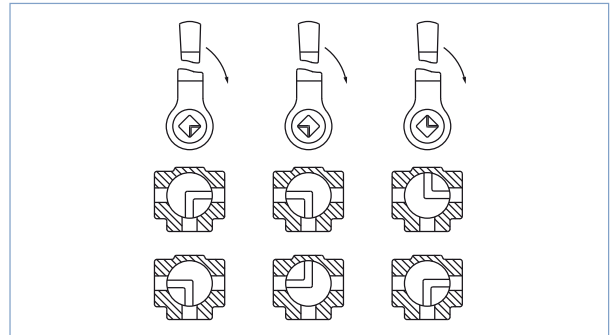

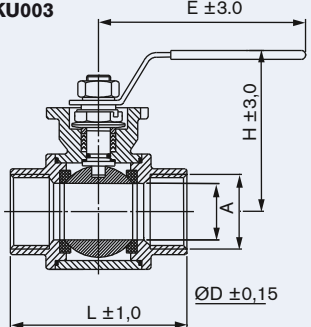





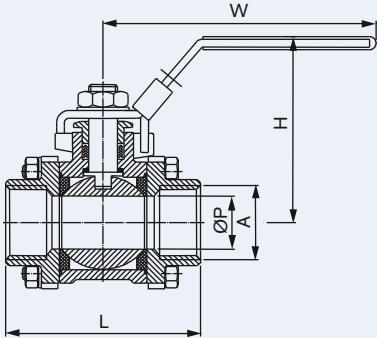

Schaltstellungen  
L-Bohrungen













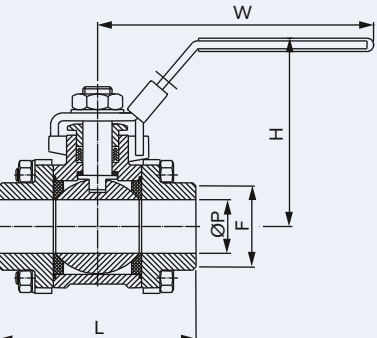

| TKU002<br>TKU003  | Werkstoffe                   | Temperaturbereich        | DN [mm] | LTA | L [mm] | K <sub>v</sub> -Wert [m <sup>3</sup> /h] | PN [bar] | Artikel-Nr. L-Bohrung | Artikel-Nr. T-Bohrung |
|---|------------------------------|--------------------------|---------|-----|--------|--|----------|-----------------------|-----------------------|
|   |                              |                          |         |     |        |  |          |                       |                       |
|  | Gehäuse:<br>Edelstahl 1.4401 | -10 °C<br>bis<br>+200 °C | 11      | ¼"  | 80,5   | 2,8                                      | 63       | 789439                | 789446                |
|   | Kugel:<br>Edelstahl 1.4401   |                          | 12      | ⅜"  | 80,5   | 3  | 63       | 789493                | 789447                |
|   |                              |                          | 15      | ½"  | 80,5   | 3,6                                      | 63       | 789331                | 789448                |
|   | Dichtung: PTFE               |                          | 20      | ¾"  | 88     | 6  | 63       | 789441                | 789449                |
|   | O-Ring: FKM                  |                          | 25      | 1"  | 100    | 11                                       | 63       | 789442                | 789397                |
|   | Hebel: Edelstahl<br>1.4301   |                          | 32      | 1¼" | 140    | 25,5                                     | 63       | 789444                | 789451                |
|   |                              |                          | 40      | 2"  | 170    | 37,5                                     | 63       | 789445                | 789452                |

## Bestell-Tabelle 2- und 3-Wege-Kugelhähne, Edelstahl-Gehäuse, Forts.

## 3-teilig, Gewindemuffe

| TKU001  | Werkstoffe                   | Temperaturbereich        | DN [mm] | LTA | L [mm] | K <sub>v</sub> -Wert [m <sup>3</sup> /h] | PN [bar]   | Artikel-Nr.  |
|---|------------------------------|--------------------------|---------|-----|--------|--|--|--|
|   |                              |                          |         |     |        |  |  |  |
|  | Gehäuse:<br>Edelstahl 1.4408 | -10 °C<br>bis<br>+200 °C | 8       | ¼"  | 60     | 5,4                                      | 63   | 789453  |
|   |                              |                          | 10      | ⅜"  | 60     | 6  | 63   | 789454  |
|   | Kugel:<br>Edelstahl 1.4401   |                          | 15      | ½"  | 75     | 16,3                                     | 63   | 789455  |
|   | Dichtung: PTFE               |                          | 20      | ¾"  | 80     | 29,5                                     | 63   | 789456  |
|   | O-Ring: FKM                  |                          | 25      | 1"  | 90     | 43                                       | 63   | 789457  |
|   | Hebel:<br>Edelstahl 1.4301   |                          | 32      | 1¼" | 110    | 89                                       | 63   | 789458  |
|   |                              |                          | 40      | 1½" | 120    | 230                                      | 63   | 789459  |
|   |                              |                          | 50      | 2"  | 140    | 265                                      | 63   | 789460  |
|   |                              |                          | 65      | 2½" | 185    | 540                                      | 63   | 789461  |
|   |                              |                          | 80      | 3"  | 205    | 880                                      | 63   | 789373  |
|   |                              | 100                      | 4"      | 240 | 1380   | 63                                       | 789463  |  |

## 3-teilig, Schweißanschluss

| TKU001  | Werkstoffe                   | Temperaturbereich        | DN [mm] | P Ø [mm] | F [mm] | L [mm] | K <sub>v</sub> -Wert [m <sup>3</sup> /h] | PN (80 °C) [bar]   | Artikel-Nr.  |
|---|------------------------------|--------------------------|---------|----------|--------|--------|--|--|--|
|   |                              |                          |         |          |        |        |  |  |  |
|  | Gehäuse:<br>Edelstahl 1.4408 | -10 °C<br>bis<br>+200 °C | 8       | 11,6     | 12,5   | 65     | 5,4                                      | 63   | 789464  |
|   |                              |                          | 10      | 12,7     | 15     | 70     | 6  | 63   | 789465  |
|   | Kugel:<br>Edelstahl 1.4401   |                          | 15      | 16       | 18     | 75     | 16,3                                     | 63   | 789430  |
|   | Dichtung: PTFE               |                          | 20      | 20       | 22     | 90     | 29,5                                     | 63   | 789467  |
|   | O-Ring: FKM                  |                          | 25      | 25       | 28     | 100    | 43                                       | 63   | 789468  |
|   | Hebel: Edelstahl 1.4301      |                          | 32      | 32       | 35     | 110    | 89                                       | 63   | 789469  |
|   |                              |                          | 40      | 38,1     | 43     | 125    | 230                                      | 63   | 789470  |
|   |                              |                          | 50      | 50,8     | 54     | 150    | 265                                      | 63   | 789471  |
|   |                              |                          | 65      | 65       | 69     | 190    | 540                                      | 63   | 789472  |
|   |                              |                          | 80      | 80       | 84     | 220    | 880                                      | 63   | 789473  |
|   |                              | 100                      | 100     | 104      | 270    | 1380   | 63                                       | 789474  |  |

Klicken Sie bitte hier, um die für Sie zuständige Bürkert Niederlassung in Ihrer Nähe zu finden →

[www.burkert.com](http://www.burkert.com)Bei speziellen Anforderungen  
beraten wir Sie gern.Änderungen vorbehalten.  
© Christian Bürkert GmbH & Co. KG

1803/5\_DE-de\_00897092