

# Hybrid Recorder

## SR Series

### Instruction Manual

### Communication Interface

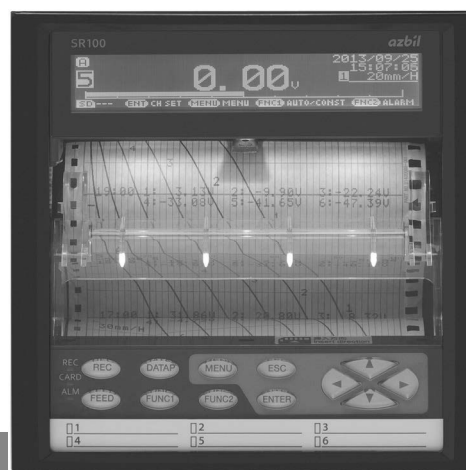

**Thank you for purchasing the SR series Hybrid Recorder.**

**This manual contains information for ensuring the correct use of the SR series Hybrid Recorder. It also provides necessary information for installation, maintenance, and troubleshooting. This manual should be read by those who design and maintain equipment that uses the SR series Hybrid Recorder. Be sure to keep this manual nearby for handy reference.**

Azbil Corporation

# Table of contents

<b>1. Introduction</b>	<b>1</b>
<b>2. For Safe Use</b>	<b>2</b>
2-1. Preconditions for Use	2
2-2. Symbol Mark	2
<b>3. Overview</b>	<b>3</b>
3-1. RS232C Communication Interface	3
3-2. RS422A/485 Communication Interface	3
3-3. Ethernet	3
<b>4. Communications Protocol</b>	<b>4</b>
4-1. MODBUS Protocol	4
4-2. PRIVATE Protocol	4
<b>5. Communication Specifications</b>	<b>5</b>
5-1. MODBUS	5
5-2. PRIVATE	5
5-3. Ethernet	5
<b>6. Communication Parameter Settings</b>	<b>8</b>
6-1. Ethernet Settings	8
6-2. COM Settings	9
<b>7. Wiring</b>	<b>10</b>
7-1. Precautions on Wiring	10
7-2. Communication Cable	11
7-3. Communication Line Wiring	13
<b>8. MODBUS Protocol</b>	<b>16</b>
8-1. Message Transmission Mode	17
8-2. Data Time Interval	18
8-3. Message Structure	18
8-4. Message Creation	24
8-5. Function Code	25
8-6. Response to Abnormal Situation	33
8-7. Title Printing (Message Printing 2) Function	35
8-8. Data Communications Input	35
8-9. Reference Table	36
8-10. Range No. Reference Table	100
<b>9. PRIVATE Protocol</b>	<b>101</b>
9-1. Basic Communication Sequence	102
9-2. Control Character Code	102
9-3. Data Link	102
9-4. Data Transmission and Reception	103
9-5. Checksum	106
<b>10. Web Settings/Display</b>	<b>107</b>
10-1. Top Page	107
10-2. Display	108
10-3. Parameters Set by Each CH	109
10-4. Calculation	113
10-5. Dotting/Printing	115
10-6. Remote Contacts (Option)	122
10-7. Communication	124
10-8. SD Card	128
10-9. System	129

---

# 1. Introduction

---

Thank you for purchasing SR series.

Make sure to read this instruction manual in advance to understand this unit well and prevent troubles from occurring. This manual is a "Communications" instruction manual. For specifications with communications, read the "General" instruction manual separately.

## Request

### - To the persons doing instrumentation, installation, and sales -

Make sure to provide this instruction manual to the person who uses the unit.

### - To the users of this unit -

Store this instruction manual with care until you scrap the unit.

Also, write down the parameter contents set in the product and keep it for your record.

## Product warranty scope

This product is warranted for one year from the date of delivery. If it is damaged during the warranty period, when used normally based on the cautions in the instruction manual labels attached to the product, etc., it will be repaired without any charge (only in Japan). In the case, we are sorry to trouble you, but please contact your dealer or nearest our sales office.

However, in cases of the followings, it will be repaired at your expense even during warranty period.

1. Failure or damage caused by improper use or connection, or invalid repair or modification.
2. Failure or damage caused by fire, earthquake, wind or flood, thunderbolt, or other extraordinary natural phenomena, or pollution, salt, harmful gas, abnormal voltage, or use of unspecified power.
3. Replacement of parts or accessories that have reached the end of their life.

Furthermore, the term 'warranty' in this sense covers only an Azbil's product itself. Therefore, we are not responsible for compensation for whatever the damage that is triggered by failure of our product.

## Notice

1. No part of this manual can be reproduced or copied in any form without permission.
2. The contents of this manual may be altered without prior notice.
3. This manual has been documented by making assurance doubly sure. However, if any question arises or if any error, an omission, or other deficiencies are found, please contact your nearest our sales office.
4. Azbil is not responsible for any operation results of this software.

## Trademark

1. Microsoft, Windows, Windows XP, Windows Vista, Windows 7, and NET Framework are trademarks of Microsoft Corporation and the related company.
2. SD Memory Card is the trademark of Panasonic Corporation, SanDisk Corporation in USA, and TOSHIBA CORPORATION.
3. Other described company names and product names are trademarks and registered products of the respective companies.
4. Please note that the marks "TM" and "®" are omitted throughout this manual.

## Warning

### Perchlorate Material

This instrument uses battery with Perchlorate Material.

Special handling may apply, see

<http://www.dtsc.ca.gov/hazardouswaste/perchlorate>

---

## 2. For Safe Use

---

For safe use of the unit, please read and understand the following cautions.

### 2-1. Preconditions for Use

The unit is a component type general product to be used mounted on an indoor instrumentation panel. Avoid using under other conditions.

Use after the system safety is implemented such as the fail-safe design and periodical inspection on the final product side. Also, for wiring/adjustment/operation of the unit, ask professionals with instrumentation knowledge to perform.

In communications interfaces, communication errors in some probabilities are unavoidable due to the timing and noise between instruments.

For your machines and devices, please perform retry processing, fail safe design, safety design and so on.

Furthermore, also the person who actually uses the unit is required to read this instruction manual to fully understand various cautions and basic operation.

### 2-2. Symbol Mark

This instruction manual includes the following symbol marks. Make sure to fully understand their meaning.

Symbol mark	Meaning
 <b>Caution</b>	Cautions are explained to avoid causes for slight injuries of users or damages of the unit or peripheral devices.

---

## 3. Overview

---

The unit is equipped with the communication interfaces such as RS232C, RS422A, RS485 and Ethernet to communicate with a personal computer (PC). Receiving measured data, setting various parameters and sending operation commands can be performed on a PC.

The number of connectable units is one for RS232C and 31 at maximum for RS422A/485.

### 3-1. RS232C Communication Interface

RS232C is a data communications standard developed and published by Electronic Industries Association (EIA), which is equivalent to JIS C 6361 of Japanese standard.

Originally, RS232C is an interface between a modem and connected data terminal equipment, and the standard specifies electrical and mechanical specifications only.

Currently, there is few RS232C communication interfaces used for PCs or industrial instruments like this unit which meet the above standard completely. There are cases where the number of signal cables or the connector differs from the standard.

Also, the standard does not specify software, or “data transmission procedure”, so it means that connection between devices with RS232C communication interface is not always possible. For this reason, users need to research or check the specifications and transmission procedures of devices to be connected beforehand. However, a device like PC which allows arbitrary programming of specifications can be combined with any device by creating an appropriate program. To research the RS232C standards, referring to JIS C 6361 may be the easiest way.

### 3-2. RS422A/485 Communication Interface

With RS422A/485 communication interface, multiple units (up to 31) of this series can be connected in parallel to establish communication using signals conforming to RS422A/485.

There are not many PCs having RS422A/485 communication interface, however, serial communication enables easy connection setup using a signal converter between RS232C  $\longleftrightarrow$  RS422A/485.

A line converter for RS232C  $\longleftrightarrow$  RS422A/485 signal conversion is available from us. Contact us when you need it.

The difference between RS422A and RS485 is that RS422A uses four signal cables whereas RS485 uses only two signal cables.

### 3-3. Ethernet

Ethernet is a communication interface standardized as IEEE802, 3 in 1983. It is widely used as the most common communication medium in small-scale LAN. The SR series is connected to LAN constructed by Ethernet to receive measured data or set various parameters.

---

## 4. Communications Protocol

---

The unit has the following two communications protocols which can be switched using the front keys.

### 4-1. MODBUS Protocol

MODBUS is a registered trademark of Schneider Electric.

MODBUS protocol has RTU mode and ASCII mode which can be selected using the front keys or via communication. This protocol provides measured data transmission, setting and operating functions.

For Ethernet interface, MODBUS protocol is implemented on TCP protocol packet to establish communication (see section 5-3).

### 4-2. PRIVATE Protocol

This protocol can be selected using the front keys. It provides measured data transmission, setting and operating functions.

Two types of modes are available: PRIVATE1 and PRIVATE2, and these can be selected using the front keys.

PRIVATE1	No connection sequence
PRIVATE2	Connection sequence available

PRIVATE1: With RS232C, data link is not necessary due to one-to-one communication with the host.  
Select PRIVATE1 for RS232C.

PRIVATE2: With RS422A and RS485, data link is required.  
Select PRIVATE2 for these interfaces. Also, select PRIVATE2 for RS232C when the software of the host is shared since data link commands can be received.

The parameters which cannot be handled by PRIVATE are now settable by MODBUS. We recommend MODBUS protocol to customers who construct a new communication environment.

---

## 5. Communication Specifications

---

### 5-1. MODBUS

Communication system	:	Half-duplex start-stop synchronization
Protocol	:	MODBUS protocol
Transmission speed	:	9600, 19200, 38400bps selectable
Start bit	:	1 bit
Data length	:	7 bits (ASCII mode) 8 bits (RTU/ASCII mode)
Parity bit	:	Non (None) /Even/Odd
Stop bit	:	1 bit/2 bits
Transmission code	:	ASCII (ASCII mode) Binary (RTU mode)
Error check (Error detection)	:	LRC (ASCII mode) CRC-16 (RTU mode)
Data transmission procedure	:	None
Used signals	:	Transmitted/received data only (no control signal used)

### 5-2. PRIVATE

Communication system	:	Half-duplex start-stop synchronization (polling selecting system)
Protocol	:	PRIVATE protocol
Transmission speed	:	1200, 2400, 4800, 9600bps selectable
Start bit	:	1 bit
Data length	:	7 bits/8 bits
Parity bit	:	Non (None) /Even/Odd
Stop bit	:	1 bit/2 bits
Transmission code	:	ASCII
Error check (Error detection)	:	BCC (block check character) checksum
Data transmission procedure	:	None
Used signals	:	Transmitted/received data only (no control signal used)

### 5-3. Ethernet

Medium	:	Ethernet (10BASE-T/100BASE-TX)
Communication mode	:	Full-Duplex/Half-Duplex
Transmission speed	:	10Mbps (10BASE-T)/100Mbps (100BASE-TX) Note that transmission speed and communication mode are automatically recognized and cannot be set to fixed value.
Protocol	:	MODBUS (RTU) protocol on TCP/IP
Simultaneous connection	:	1 (in host communication using MODBUS protocol)

The SR series provides a Web setting function on Ethernet (see section 11).

The following table shows association with TCP/IP layers in MODBUS communication.

TCP/IP model layers	Main protocol used in Ethernet communication
Application layer	MODBUS
Transport layer	TCP
Internet layer	IP, ARP
Physical/data link layer	Hardware (Ethernet)

For details of MODBUS protocol, see "8. MODBUS Protocol".

## 1. Establishing TCP connection

To establish communication between a PC (makes data request: client) and the unit (receives data request: server), establish TCP connection first according to the following procedure.

- (1) PC sends a TCP packet with SYN flag set to the unit.
- (2) When the unit receives the SYN packet, it sends a TCP packet with SYN + ACK flag set to the PC.
- (3) When the PC receives the SYN + ACK packet, it sends a TCP packet with ACK flag set to the unit.

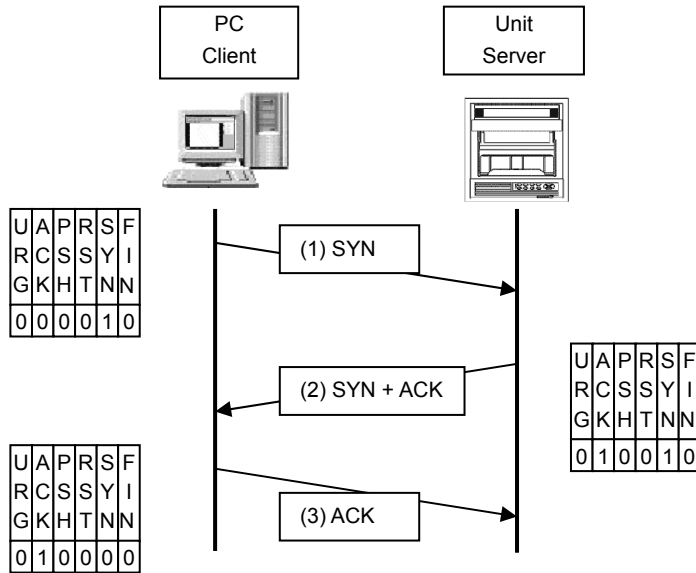

## 2. Transmitting/receiving data by TCP

Once the connection has been established, various data are transmitted/received between PC (client) and the unit (server) via MODBUS (RTU) protocol on TCP data.

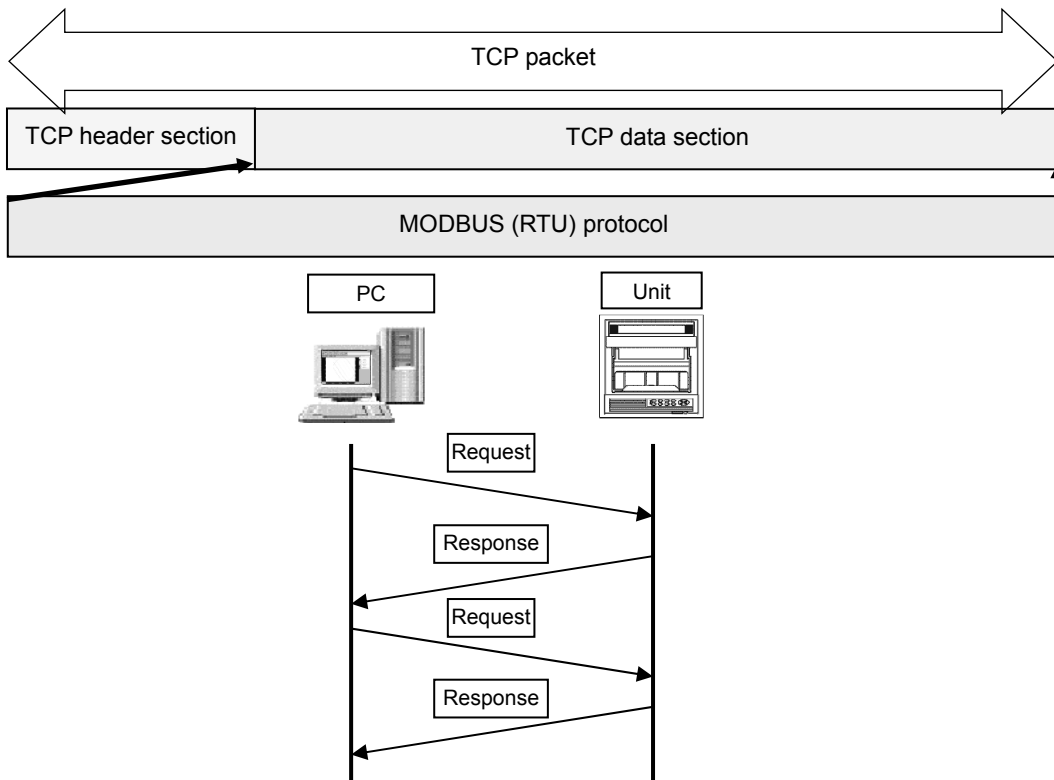



### 3. Disconnecting TCP connection

TCP connection is disconnected with the following flow of communications.

- (1) PC sends a TCP packet with FIN flag set to the unit (disconnection notice).
- (2) When the unit receives the FIN packet, it sends a TCP packet with ACK flag set to the PC.
- (3) The unit sends a FIN + ACK packet to the PC (disconnection notice).
- (4) The PC sends an ACK packet responding to FIN to the unit.

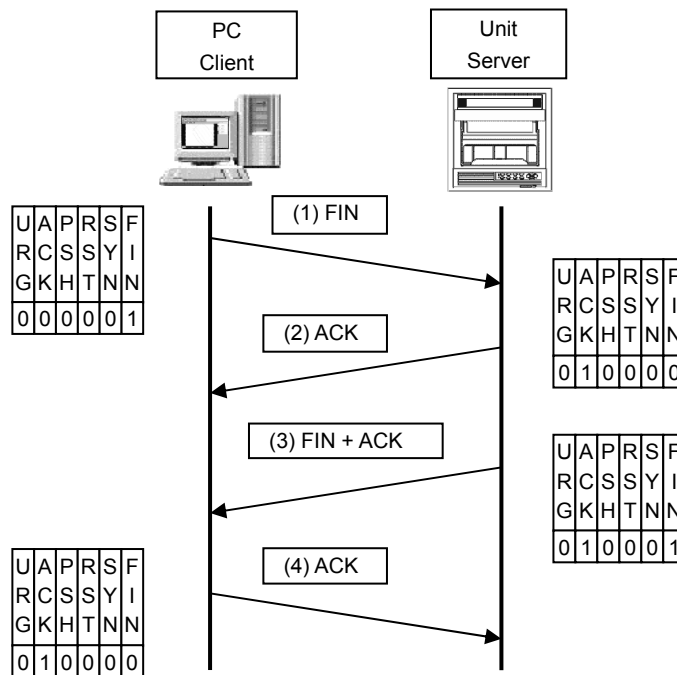

### 4. Actions against communication error

When the following communication errors occur on TCP/IP, the unit takes actions described below.

- No response from the device at the other end (PC, etc.)  
When the unit sends data to a communication target on Ethernet but no response (ACK) packet is returned, the unit repeats transmission retry operation (for around three minutes maximum).  
The unit disconnects TCP connection if no response is made to the transmission retry packet.

If a communication target makes a TCP connection request before the unit disconnects TCP connection, the unit sends an RST packet to reject the request.

The unit sends an RST packet in the following situations.

- When a TCP packet is received from devices other than that being connected.
  - When an RST packet is received from a communication target.
- Unexpected reply packet received  
Generally, unexpected reply packets are ignored. However, TCP connection is disconnected immediately after the unit receives an RST packet in situations such as when PC performs a forced disconnection of TCP connection.

# 6. Communication Parameter Settings

## 6-1. Ethernet Settings (IP Address etc... Settings)

Set each parameter.

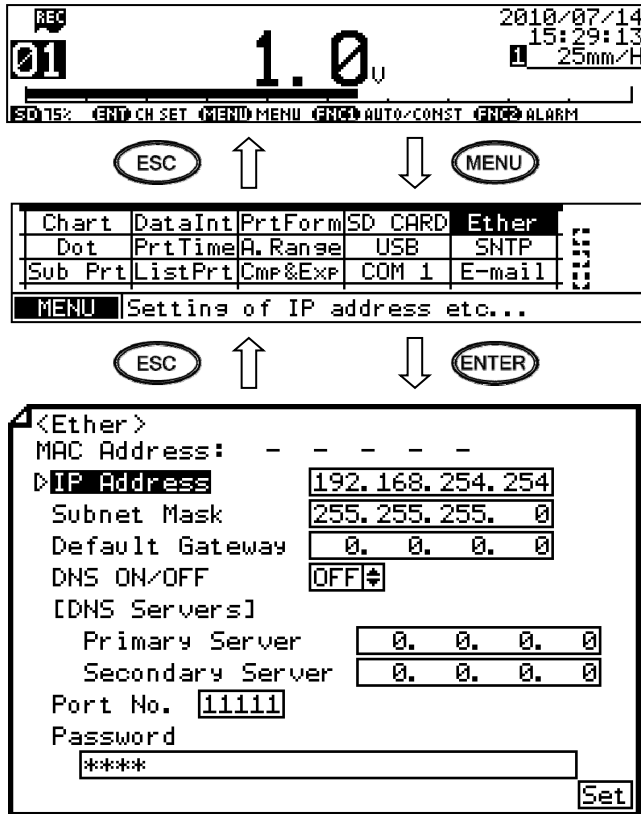

- (1) Pressing the **MENU** key displays the menu window (list of setting items).
- (2) Select "Ether".
- (3) Move the cursor to the parameter to be set with the **▲/▼/◀/▶** keys.
- (4) Press the **ENTER** key to make it available for setting and then select or enter a value.
- (5) After completing the settings of this item, move the cursor to **Set**.
- (6) Press the **ENTER** key to register the settings (when chart recording is ON, a setting change mark is printed). To cancel the settings, press the **ESC** key.

Note: Actual windows are separated. Use the **▲/▼** keys to scroll and continue settings.

[List of Ether setting parameters]

Parameter	Function	Default	Set value
MAC Address	Ethernet MAC address of the unit	Unique value	Setting disabled
IP Address	Set IP address	192.168.254.254	**.***.** (each ** area is set to 0 to 255)
Subnet Mask	Set subnet mask	255.255.255.0	**.***.** (each ** area is set to 0 to 255)
Default Gateway	Set default gateway address of the network used	0.0.0.0	**.***.** (each ** area is set to 0 to 255)
DNS ON/OFF	Select whether to use DNS (domain name server)	OFF	OFF (not used), ON (used) Set server like SNTP and SMTP by the name when using DNS, or by the IP address when not using DNS.
[DNS Servers] Primary Server	Set primary DNS server	0.0.0.0	**.***.** (each ** area is set to 0 to 255)
Secondary Server	Set secondary DNS server	0.0.0.0	**.***.** (each ** area is set to 0 to 255)
Port No.	Set port No. for socket communication by TCP/IP	11111	0 to 65535
Password	Set a password consisting of up to 32 characters used for setting on the Web	3571	

### Reference Example settings for small network

To use the unit in a small network using a router without connecting to internal LAN or internet, set the IP address as shown below.

Unit	IP address	Subnet mask
This unit A	192.168.254.254	255.255.255.0
This unit B	192.168.254.253	255.255.255.0
...	...	...
PC A	192.168.254.1	255.255.255.0
PC B	192.168.254.2	255.255.255.0
...	...	...

## 6-2. COM Settings

Set each parameter.

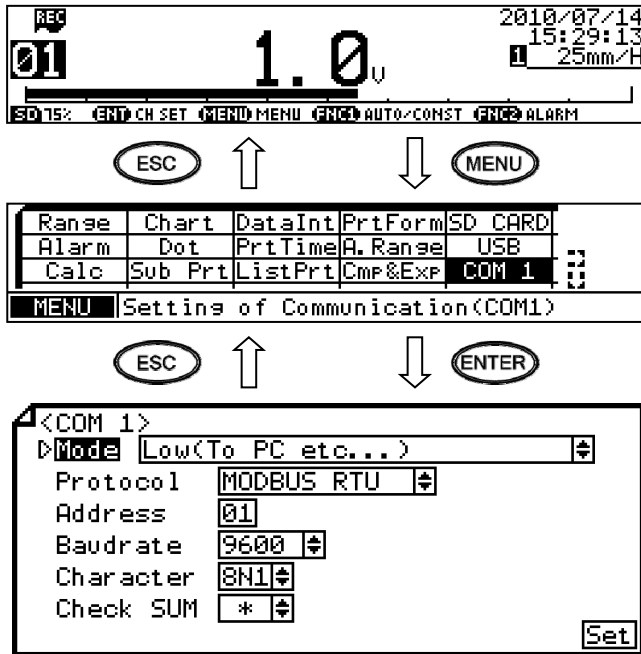

Note: Actual windows are separated. Use the ▲/▼ keys to scroll and continue settings.

- (1) Pressing the **MENU** key displays the menu window (list of setting items).
- (2) Select "COM1" or "COM2".
- (3) Move the cursor to the parameter to be set with the ▲/▼/◀/▶ keys.
- (4) Press the **ENTER** key to make it available for setting and then select or enter a value.
- (5) After completing the settings of this item, move the cursor to **Set**.
- (6) Press the **ENTER** key to register the settings (when chart recording is ON, a setting change mark is printed). To cancel the settings, press the **ESC** key.

[List of COM1 and COM2 setting parameters]

Parameter	Function	Default	Set value
Mode	Communication mode	Low(To PC etc...)	Fixed to Low (To PC etc...)
Protocol	Select communication protocol	MODBUS RTU	MODBUS RTU, MODBUS ASCII, PRIVATE1 (without connection sequence), PRIVATE2 (with connection sequence)
Address	Set communication address of the unit	01	01 to 99
Baudrate	Set communication speed	9600	PRIVATE: 1200, 2400, 4800, 9600bps MODBUS: 9600, 19200, 38400bps Changes to "9600" when changing from PRIVATE to MODBUS or vice versa.
Character	Set transmission character	8N1	7E1, 7E2, 7O1, 7O2, 8N1, 8N2, 8E1, 8E2, 8O1, 8O2
Check SUM	Select whether to add checksum code	*	OFF, ON Settable only when Protocol is set to "PRIVATE".

### Reference Character selection

Codes are used to represent characters. MODBUS RTU mode can set only 8-bit characters (see section 8-1).

Code	Character length	Parity	Stop bit	Code	Character length	Parity	Stop bit
7E1	7-bit	Even	1	8N2	8-bit	Non	2
7E2	7-bit	Even	2	8E1	8-bit	Even	1
7O1	7-bit	Odd	1	8E2	8-bit	Even	2
7O2	7-bit	Odd	2	8O1	8-bit	Odd	1
8N1	8-bit	Non	1	8O2	8-bit	Odd	2

- \* When connecting via Ethernet, communication protocol and communication address are fixed to "MODBUS RTU" and "01" respectively.
- \* Use the unit and PC at the same communication speed (use the default speed 9600bps in normal case).
- \* For RS422A/485, a communication address of the unit needs to be set. Make sure that one or more units connected to a PC have unique communication address and no overlap occurs.  
For RS232C, only one unit is connected, but communication address needs to be set (use the default address 01 in normal case).

# 7. Wiring

## 7-1. Precautions on Wiring

### 1. Communication terminal

Terminal layout depends on the selection of communication interface.

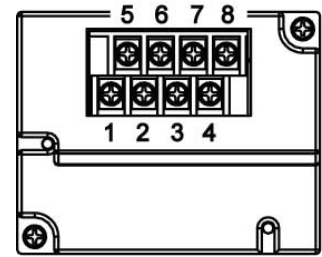

		1	2	3	4	5	6	7	8
COM1	RS232C				SG	SD		RD	
	RS422A				SG	SDA	SDB	RDA	RDB
	RS485				SG	SA	SB	Short with SA	Short with SB
COM2	RS485	SA	SB	SG					

\* RS232C and RS422A/485 of COM1 are specified on purchase.

### 2. RS422A/485 communication cable extended up to 1.2km

The interval between instruments can be decided freely, however, note that the total cable length should be 1.2km or less.

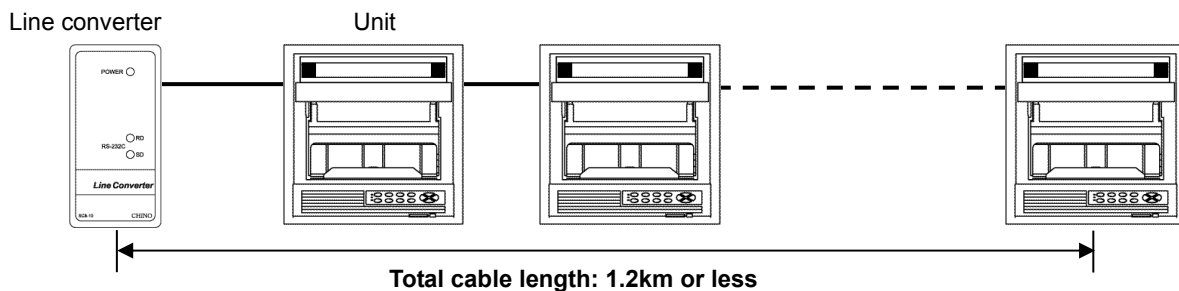

### 3. Take measure against noise

To avoid interference from noise, keep the communication cable separated from the power or other communication cables, with a gap of at least 50cm between them.

### 4. Make sure to use crimping terminals

One of the causes of communication failure is a disconnection of cables. Make sure to install an O type or Y type crimping terminal with insulation sleeve to the end of communication cable.

Terminal board	Diameter	Tightening torque	Termination treatment (unit: mm)
Communications terminal	M3	0.5 N·m	<p>O type</p> <p>With an insulation sleeve</p> <p>Y type</p> <p>With an insulation sleeve</p> <p>* O type is preferred.</p>

## 5. Add termination resistor

For RS422A/485 communications, install a 100Ω resistor to the unit which is located at the last edge of the communication line.

(See section 7-3.2 and 7-3.3.)

## 6. Number of connectable units

RS232C: One unit

RS422A/485: Up to 31 units



### Caution

The number of connectable units specified above is based on the use of communication IC conforming to the communication standards. However, the number of units or distance ensuring high quality communication varies depending on the type of communication cable and other connected devices.

## 7-2. Communication Cable

Prepare a communication cable before wiring. Dedicated cables are available from us. Contact us when you need it.

### 1. RS232C

Connection between PC and the unit or a line converter

Cable	9-pin connector ↔ Crimp type ring terminals RS232C cable
Shape	
Internal wiring	



### 3. RS485

Connection between the unit and other devices and between a line converter and the unit

Cable	Crimp type ring terminals ← → Crimp type ring terminals RS485 cable
Shape	<p>Device/line converter side</p> <p>Recorder side</p> <p>2-core cable of twisted CVVS lines. Each side has a SG (single ground) line. Since the line converter has no SG terminal, cut and use the cable.</p>
Internal wiring	<p>RDA ○</p> <p>RDB ○</p> <p>SG ○</p> <p>SA ○</p> <p>SB ○</p> <p>SG ○</p>

### 4. Ethernet

- Connection between PC and device  
When connecting a device to a PC directly (one-to-one), use a shielded, crossover twisted pair cable (commercially available STP cable).
- Connection between HUB and device (multiple devices can be connected)  
When connecting devices to a PC via HUB (one-to-N), use a shielded, straight twisted pair cable (commercially available STP cable).

## 7-3. Communication Line Wiring

### 1. RS232C wiring

PC and device are connected one-to-one in RS232C communication.

Example of terminal connection

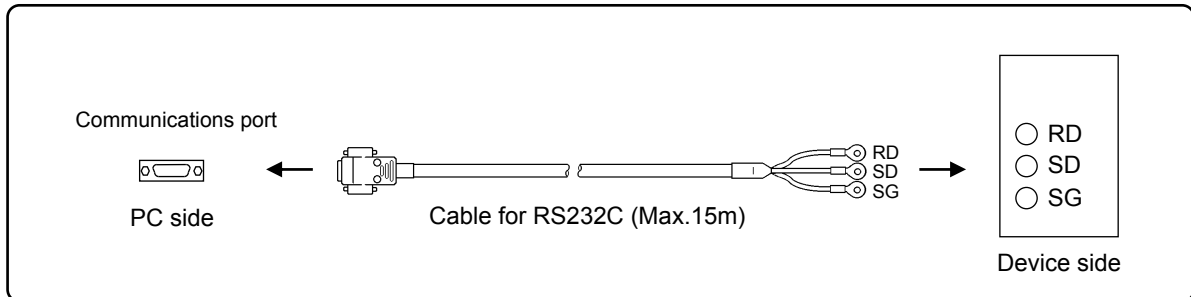

## 2. RS422A wiring

PC and multiple devices are connected in RS422A communication. A line converter is required. RS422A cable is within 1.2km of total extension and up to 31 devices can be connected. Install a resistor of 100Ω to the last edge of the transmission line device side. (General metal film resistors will be fine. They are available from us, so contact us when you need it.)

Example of terminal connection

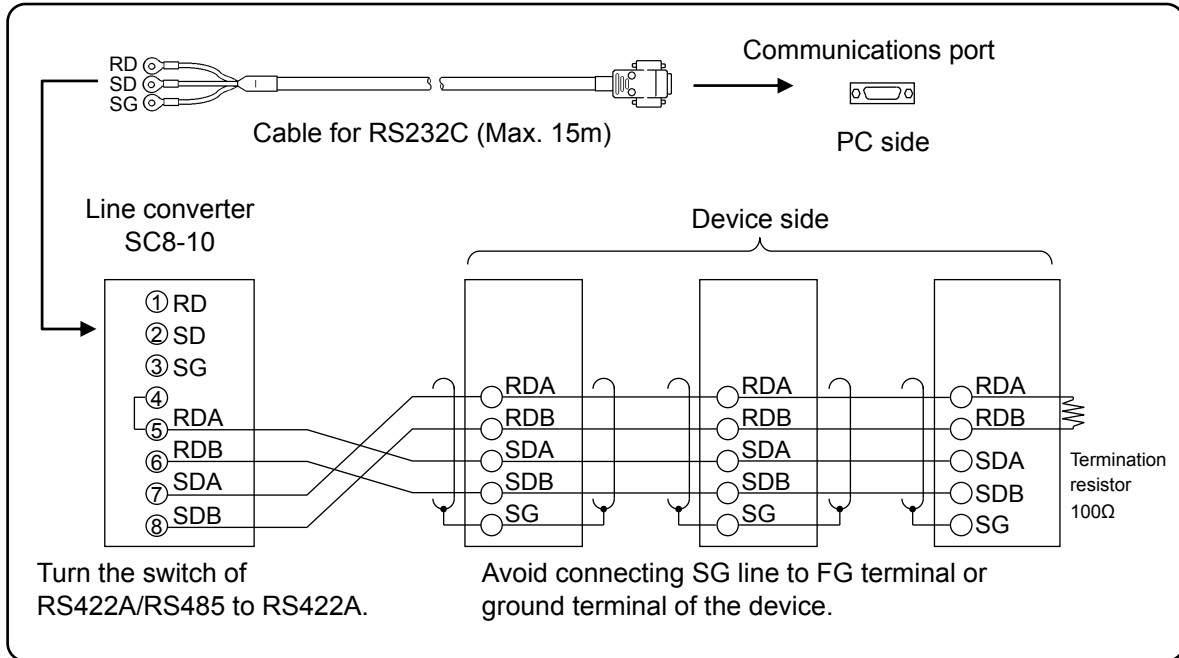

## 3. RS485 wiring

PC and multiple devices are connected in RS485 communication. A line converter is required. RS485 cable is within 1.2km of total extension and up to 31 devices can be connected. Install a resistor of 100Ω to the last edge of the transmission line device side. (General metal film resistors will be fine. They are available from us, so contact us when you need it.)

Example of terminal connection

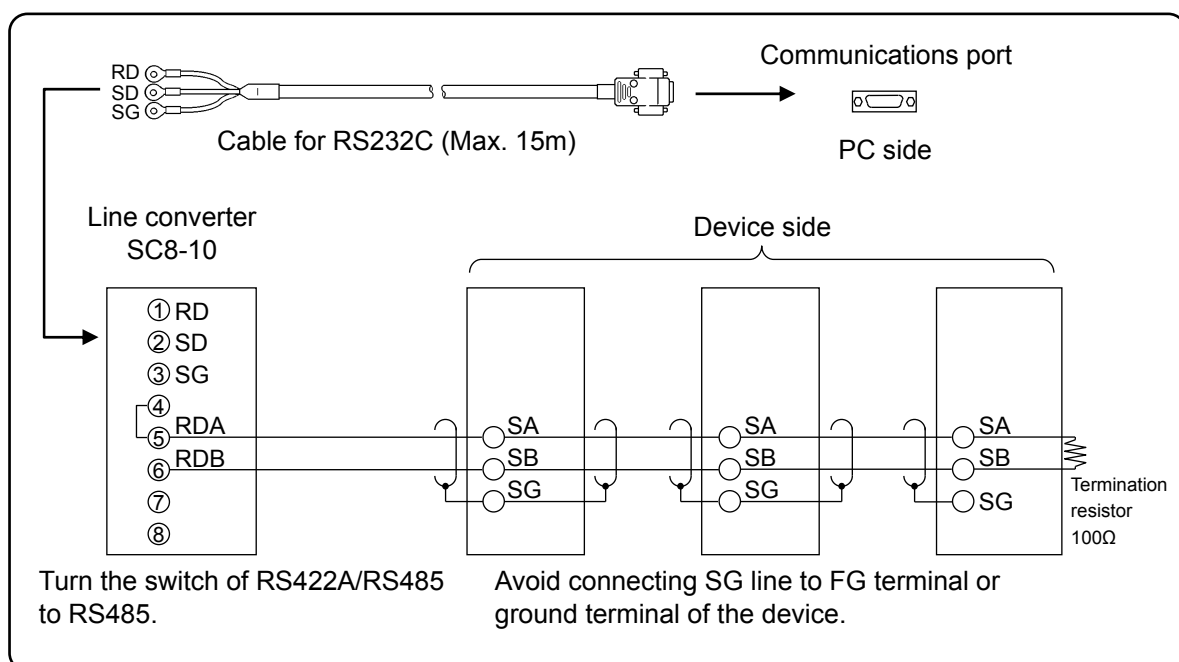



#### 4. Ethernet wiring

- Example of connection between PC and Ethernet device (one-to-one connection)

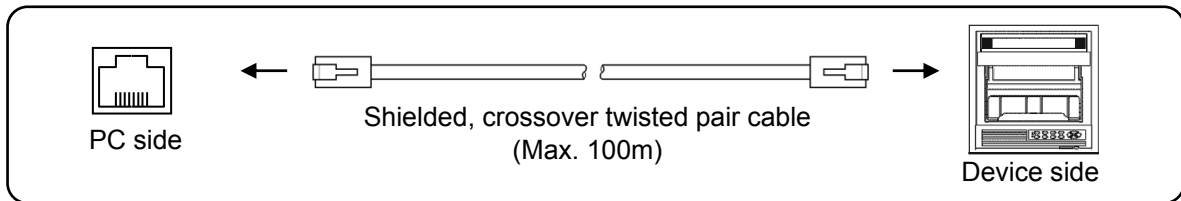

- Example of connection between PC, HUB and Ethernet device (one-to-N connection)

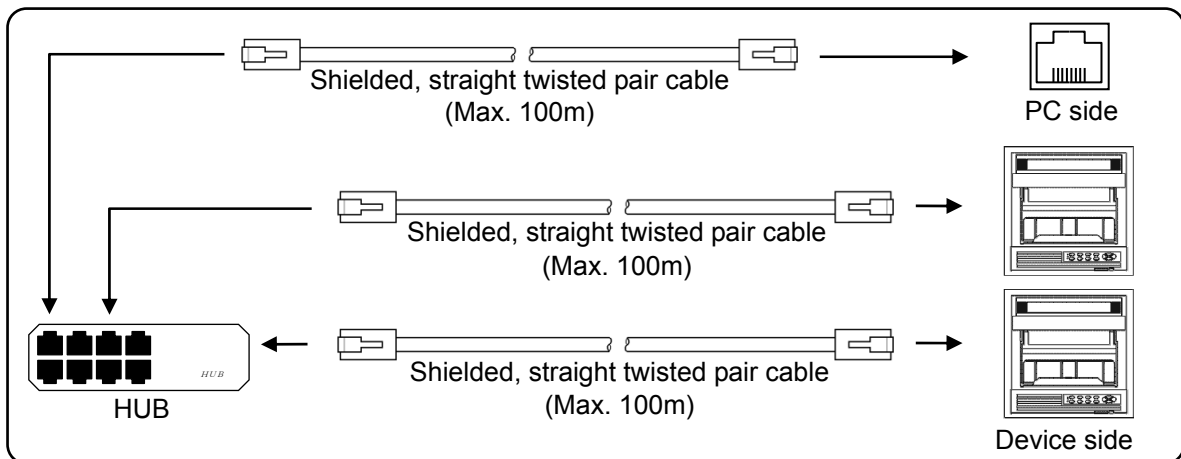

---

## 8. MODBUS Protocol

---



### Caution

Make sure to read and understand this section to avoid any troubles.

#### 1. Requesting data immediately after power-on generates an error

The unit is always ready for communications and responsive to data request from PC. However, after power-on, the unit does not respond normally until channel data becomes ready.

For example, it takes about 20 seconds for a 24-point recorder to have the data ready. When a data request is received during this period, the unit returns an error.

#### 2. Keys restricted in parameter setting (writing)

When operating the unit from PC to set parameters, etc., the **ENT** / **ENTER** key becomes temporarily unavailable while a setting window is displayed. The key will be available again by changing the window displayed.

#### 3. RS232C requires communication address

Although PC and the unit are connected one-to-one in RS232C communication, a communication address needs to be set to establish communication.

#### 4. Be careful about command re-transmission as no control signal line is used

The serial interface of the unit makes communication without using a control line. Therefore, attention should be paid when re-transmitting a command since reception failure may occur depending on the unit condition.

#### 5. Do not disconnect communication cable or device, or turn ON/OFF the power during communication

Disconnecting the cables or devices constituting the serial interface, or turning ON/OFF the devices during communication may stop operation or generate an error. If this happens, all the devices constituting the serial interface need to be reset to start the operation from the beginning.

#### 6. Make sure that communication driver has been turned OFF before sending next command

For RS422A/485 communication, multiple devices are connected in the same communication line, but only one device whose communication address is specified by PC passes through the communication line. To send all characters safely to PC, the communication line driver is turned OFF a few moments (about 5ms) after sending the last character. If a PC sends a command to the next device before the driver is turned OFF, signals will interfere with each other resulting in communication failure.

## 8-1. Message Transmission Mode

Two types of message transmission mode are available: RTU (Remote Terminal Unit) mode and ASCII mode, which can be selected using the front keys.

Comparison between RTU and ASCII modes

Item		RTU mode	ASCII mode
Interface		RS232C, RS422A, RS485	
Communication system		Half-duplex start-stop synchronization	
Transmission speed		9600, 19200, 38400bps	
Transmission code		Binary	ASCII
Error check (Error detection)	Vertical	Parity	
	Horizontal	CRC-16	LRC
Character configuration	Start bit	1 bit	
	Data length	8 bits	7 bits, 8 bits
	Parity bit	None, odd, even	None*, odd, even
	Stop bit	1bit/2 bits	
Message start code		None	: (Colon)
Message end code		None	CR, LF
Data time interval		28-bit time or less	1 second or less

\* For the case of 7-bit data, parity bit cannot be "None".

### 1. Transmission data

The RTU mode transmits binary data. The ASCII mode divides the 8-bit binary data of RTU into high-order four bits and low-order four bits, and turns them into characters (0 to 9, A to F).

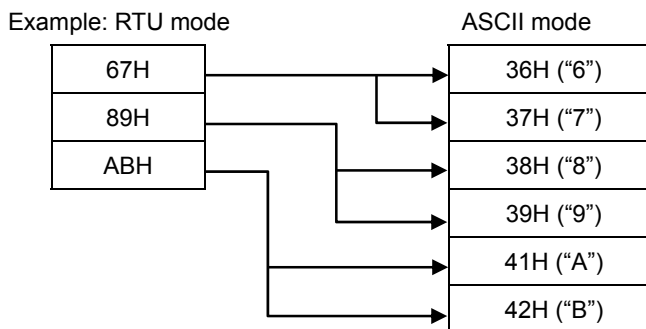

The RTU mode enables more efficient transmission since its message is half in length compared to the ASCII mode.

### 2. Message frame structure

With RTU mode, the message frame consists of message section only.

With ASCII mode, the message frame consists of start character ":", (colon, 3AH)", message and end characters "CR (carriage return, 0DH) + LF (line feed, 0AH)".

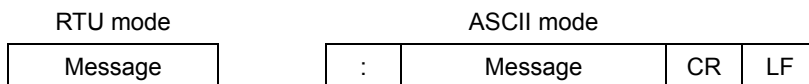

The ASCII mode makes troubleshooting easier since it uses a message start character ":".

## 8-2. Data Time Interval

RTU mode: 28-bit time or less (9600bps: 2.8msec, 19200bps: 1.4msec, 38400bps: 0.7msec)  
ASCII mode: One second or less

When sending a message, keep the time interval between data constituting one message no longer than the time specified above. If it is longer than the time specified above, the receiver side (the unit) recognizes that transmission of data from the sender side is complete, and the data is handled as an abnormal message.

While the RTU mode requires continuous transmission of message characters, the ASCII mode allows for a maximum interval of one second between characters, making it possible to use a master (PC) with a relatively slow processing speed.

## 8-3. Message Structure

MODBUS message has the following structure which is applied to both RTU and ASCII modes.

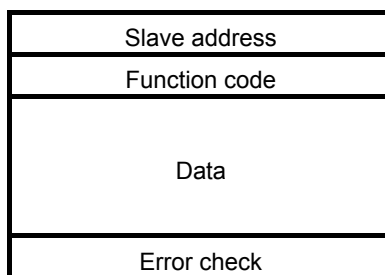

### 1. Slave address

A slave address can be set in advance using the front keys within the range of 1 to 99. Normally, master device communicates with a single slave device. Only a slave device whose address matches the slave address in a command message from the master device sends a response.

The slave address "0" is used for a message addressed to all slave devices (broadcast) from the master device. In this case, the slave devices do not send a response.

### 2. Function code

Function codes represent the functions to be executed by slave devices. The data is generally classified as shown in the table below. The table also shows the comparison between MODBUS original functions and MODBUS-compatible Azbil device functions (see section 8-9).

Function code table

Code	Function	Unit	MODBUS original function (reference)
01	Read digital (ON/OFF) settings	1 bit	Read coil status
02	Read digital input data	1 bit	Read input relay status
03	Read analog settings	16 bits	Read holding register contents
04	Read analog input data	16 bits	Read input register contents
05	Write digital setting	1 bit	Change single coil status
06	Write analog setting	16 bits	Write to single holding register
08	Send received data (for diagnosis)		Loop-back test
16	Write multiple analog settings		Write to multiple holding registers
70	Read floating data		Arbitrary command of vendors
71	Write floating data		Arbitrary command of vendors

- (1) Digital settings: Parameters mainly used to change functions such as recording ON/OFF and data printing execution.
- (2) Digital input data: Event status, etc.
- (3) Analog settings: Information of various settings  
Within the range of 16-bit numeric values (-32768 to 32767)
- (4) Analog input data: Measured data, unit specifications, etc.  
Outputs a numeric value within the 16-bit range
- (5) Floating data: When the data cannot be expressed by a numeric value within the 16-bit range (-32768 to 32767), floating data is used.

### 3. Data field

Data components depend on the function code. A master request consists of the code number of read/write target data (a relative number obtained from reference number described in the following section) and the number of data pieces. A slave response consists of the data responding to request.

Basic MODBUS data consists of 16-bit integers only, and the use of sign is specified for each data piece. Therefore, real number data such as measured data is expressed by assigning the decimal point position to a separate address to express an integer value, or by fixing the decimal point position and normalizing with the scale upper and lower limits.

This unit employs the system of assigning the decimal point position to a separate address.

The numeric data which cannot be expressed by 16-bit integers can be read or written using floating data.

 <b>Caution</b>	<p>The data field may contain the data like input data which assigns a specific numeric value as error data. When handling such data, perform error judgment on the data before combining with decimal point data.</p> <p>When decimal point data is combined first, error data is recognized as normal data.</p>
--	---

### 4. Reference number.

All the data handled by the unit has “reference number” assigned, and this number is required when reading/writing data.

The data is classified into “Digital settings”, “Digital input data”, “Analog input data”, “Analog settings” and “Floating data (floating point data)” by its type.

A “relative number” corresponding to the reference number is specified in a message.

Reference numbers and corresponding relative numbers

Data type	Reference No.	Relative No.	MODBUS original function (reference)
Digital settings	1 to 10000	Reference No. - 1	Coil
Digital input data	10001 to 20000	Reference No. - 10001	Input relay
Analog input data	30001 to 40000	Reference No. - 30001	Input register
Analog settings	40001 to 50000	Reference No. - 40001	Holding register
Floating data (Floating point data)	50001 to 60000	Reference No. - 50001	

For example, a relative number of “Reference No. 30101 (CH1 data)” described later is “100”.



## 5. Error check

The type of error check performed on transmission frame depends on the transmission mode.

RTU mode: CRC-16

ASCII mode: LRC

### 1) CRC-16 calculation

In CRC system, the data to be transmitted is divided by a generating polynomial and the resulting remainder is appended to the data. The generating polynomial is shown below.

$$1 + X^2 + X^{15} + X^{16}$$

Calculation is performed to the part from slave address to the end of data according to the following procedure.

- (1) Initialize CRC-16 data (referred to as X) (= FFFFH)
- (2) Exclusive logical sum (EX-OR) between data 1 and X → X
- (3) Shift X one bit to the right → X
- (4) When a carry is generated, perform EX-OR with A001H. If not, go to step (5) → X
- (5) Repeat steps (3) and (4) until eight shifts have been performed.
- (6) EX-OR between the next data and X → X
- (7) Same as steps (3) to (5)
- (8) Repeat until the last data.
- (9) Create a message of the calculated 16-bit data (X). The low-order portion is followed by the high-order portion.

Example: For [02H] [07H] data, CRC-16 value becomes 1241H therefore the error check data will be [41H] [12H].

## Reference: CRC-16 calculation program

```
/***** CRC-16 calculation program (C language) *****/
#include <stdio.h>
#include <conio.h>

void main(void)
{
    /*** Internal variable declaration ***/
    unsigned intiLoopCnt; /* Loop counter*/
    unsigned shortusData; /* Input data*/
    unsigned shortusCrcData; /* CRC-16 data*/
    unsigned shortusErrChkData; /* Error check data*/
    intiDummy; /* Dummy variable*/

    /* Initialize CRC-16 output data */
    usCrcData = 0xffff;

    printf("Enter hexadecimal data (exit by [q]) >¥n");
    while( scanf("%x",&usData) != 0 )
    {
        /* Perform exclusive OR between CRC output result and input data */
        usCrcData = usData ^ usCrcData;

        /*** Perform CRC calculation ***/
        /* Repeat until 8 bits have been shifted */
        for( iLoopCnt = 0 ; iLoopCnt < 8 ; iLoopCnt++ )
        {
            /* Check if carry is generated */
            if( usCrcData & 0x0001 )
            {
                /* Carry generated */
                /* Shift CRC output result 1 bit to the right */
                usCrcData = usCrcData >> 1;

                /* Perform exclusive OR with A001H */
                usCrcData = usCrcData ^ 0xa001;
            }
            else
            /* Carry not generated */
            /* Shift CRC output result 1 bit to the right */
            usCrcData = usCrcData >> 1;
        } /* for */
    } /* while */

    printf( "CRC-16 data is %xH.¥n", usCrcData );

    /* Create error check data */
    usErrChkData = ( usCrcData >> 8 ) | ( usCrcData << 8 );
    printf( "Error check data is %xH.", usErrChkData );

    iDummy = getch();
}
```



2) LRC calculation

Calculation is performed to the part from slave address to the end of data according to the following procedure.

- (1) Create a message in RTU mode.
- (2) Add up the data from the start (slave address) to the end → X
- (3) Complement X (bit inversion) → X
- (4) Add 1 ( $X = X + 1$ )
- (5) Append X as LRC value to the message.
- (6) Convert the whole data to ASCII characters.

Example: For [02H] [07H] data, LRC value becomes F7H therefore the binary message will be [02H] [07H] [F7H] and the ASCII message will be [30H] [32H] [30H] [37H] [46H] [37H].

## 6. Precautions on data processing

- (1) Since the measured data and decimal point position are assigned to separate numbers, the both pieces of information are required at data replay.
- (2) Since a single data access (change) is available, attention should be paid to the settings of related data. For example, a change of measuring range causes the related data to be initialized.
- (3) Read or write data within the range specified by reference numbers. Writing data to an undefined reference number may affect the instrument operation.
- (4) When reading consecutive reference numbers, the data of undefined reference number becomes "0".
- (5) When an error is detected while writing to consecutive reference numbers, all the settings will be invalid.

## 8-4. Message Creation

A message consists of (1) slave address, (2) function code, (3) data field and (4) error check code (see section 8-3).

The number of data pieces read/written at one time is as follows:

Transmission mode	Number of data pieces
RTU	120
RTU (floating data) ASCII	60

The following shows an example of creating a message.

Example: Reading “CH1” measured data of this unit with “slave address 02”.

### 1. RTU mode message

- (1) Slave address: 02 [02H]
- (2) Function code: 04 [04H]

The task is “Read analog input data (input register contents)”. For the case of function code “04”, specify “relative number of data in two bytes” and “number of data pieces in two bytes” to be read in the data field (see section 8-5, or 8-5.4 for “Function code: 04”).

\* The number of data bytes needs to be checked.

- (3) Data field: First relative number 100 ([00H] [64H]), number of data pieces 2 ([00H] [02H])

Measured data (analog input data) is saved through reference numbers “30001 to 40000” (see section 8-3.4).

The reference table shows that the integer part of CH1 is saved through “30101” and the decimal point position through “30102” (see section 8-9, or 8-9.3 for “Reading measured data”).

A relative number of the first reference number “30101” is:  $30101 - 30001 = 100$ , and it can be expressed as [00H] [64H] by two bytes (see section 8-3.4).

The number of data pieces to be read is “two”, the integer part of CH1 and the decimal point position, which can be expressed as [00H] [02H] by hex two bytes.

- (4) Error check: CRC-16 calculation result 2730H ([30H] [27H])

Error check in RTU mode uses CRC-16 calculation (see section 8-3.5).

From steps (1) to (3), the basic part of the message is [02H] [04H] [00H] [64H] [00H] [02H], and the CRC-16 value becomes 2730H. The error check data therefore becomes [30H] [27H].

- (5) Message: [02H] [04H] [00H] [64H] [00H] [02H] [30H] [27H]

Create a message according to the message structure (see section 8-3).

### 2. ASCII mode message

Perform LRC calculation as error check on the basic part of a message. The LRC value becomes 94H (see section 8-3.5). Convert each data piece of the basic part to ASCII code. Convert also the LRC value to ASCII code and append it to the basic part. Add a start character “.” and end characters “CR” and “LF” to the message.

Example: 02H, 04H, 00H, 64H, 00H, 02H, 30H, 27H

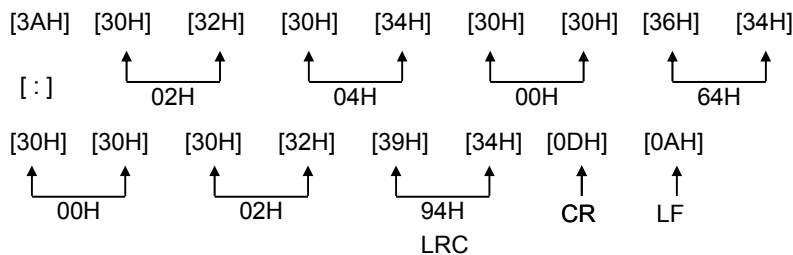

## 8-5. Function Code

Response to each function code is described below (see 8-3.2, or 8-6 for response to abnormal situation).

### 1. Read digital settings (read coil status)

Function code: 01 [01H]

This function reads the designated quantity of consecutive digital settings (ON/OFF) starting from the specified number. A single data piece (one byte) contains eight ON/OFF data bits arranged in numerical order to form a response message. LSB (D0 side) of each data piece indicates digital data of the smallest number. When the number of readings is not a multiple of eight, unnecessary bit becomes 0.

Example: Reading 10 digital settings (reference No. 8 to 17) from slave 2

Reference No.	8	9	10	11	12	13	14	15	16	17
Data	-	-	-	-	-	-	-	-	-	ON

Since no reference number exists, 0 is returned.

Recording ON

<RTU mode>

Master → Device

Slave address	02H
Function code	01H
Start No. (H)	00H
Start No. (L)	07H
Number of data pieces (H)	00H
Number of data pieces (L)	0AH
CRC (L)	0DH
CRC (H)	FFH

Device → Master (normal)

Slave address	02H
Function code	01H
Data count	02H
First 8 data bits	00H
Next 8 data bits	02H
CRC (L)	7CH
CRC (H)	3DH

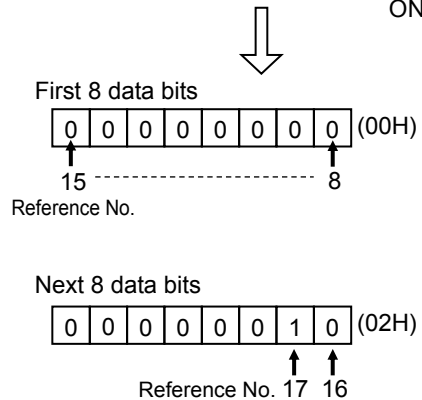

<Error check in ASCII mode>

The error check section of CRC (L) and CRC (H) is replaced with the following.

LRC	ECH	LRC	F9H
-----	-----	-----	-----

Note: Start No. (relative number) is "reference number - 1".

(Decimal value 7 (= 8-1) → hexadecimal value 07H)

Note: Data count means the number of data bytes.

(This is different from the required number of data pieces. In above example, the required number of data pieces is 10, and the data count is two.)

## 2. Read digital input data (read input relay status)

Function code: 02 [02H]

This function reads the designated quantity of consecutive digital input data (ON/OFF) starting from the specified number. A single data piece (one byte) contains eight ON/OFF data bits arranged in numerical order to form a response message. LSB (D0 side) of each data piece indicates digital data of the smallest number. When the number of readings is not a multiple of eight, unnecessary bit becomes 0.

Start No. (relative number) is "reference number – 10001".

Example: Reading four digital input settings (reference No. 10109 to 10112) from slave 2

Reference No.	10109	10110	10111	10112	10113	10114	10115	10116
Data	ON	OFF	ON	OFF	–	–	–	–

Level 1    Level 2    Level 3    Level 4                      Since no reference number exists, 0  
CH1 event                      is returned.  
status

<RTU mode>

Master → Device

Slave address	02H
Function code	02H
Start No. (H)	00H
Start No. (L)	6CH
Number of data pieces (H)	00H
Number of data pieces (L)	04H
CRC (L)	B9H
CRC (H)	E7H

Device → Master (normal)

Slave address	02H
Function code	02H
Data count	01H
First 8 data bits	05H
CRC (L)	61H
CRC (H)	CFH



First 8 data bits

0 0 0 0 0 1 0 1 (05H)

Reference No. 10112 ----- 10109

Since reference numbers 10113 to 10116 do not exist, 0 is returned.

<Error check in ASCII mode>

The error check section of CRC (L) and CRC (H) is replaced with the following.

LRC	8CH	LRC	F6H
-----	-----	-----	-----

Note: Start No. (relative number) is "reference number – 10001".

(Decimal value 108 (= 10109-10001) → hexadecimal value 6CH)

Note: Data count means the number of data bytes.

(This is different from the required number of data pieces. In above example, the required number of data pieces is four, and the data count is one.)

### 3. Read analog settings (read holding register contents)

Function code: 03 [03H]

This function reads the designated quantity of consecutive analog settings (two bytes: 16 bits) starting from the specified number. The data is divided into high-order eight bits and low-order eight bits, and then arranged in numerical order to form a response message.

Start No. (relative number) is "reference number – 40001".

Example: Reading CH1 range upper/lower limits and decimal point from slave 2

(Reading three analog settings (reference No. 40104 to 40106) from slave 2)

Reference No.	40104	40105	40106
Data	0 (0000H)	1000 (03E8H)	1 (0001H)

← Data example for 0.0 to 100.0

<RTU mode>

Master → Device		Device → Master (normal)	
Slave address	02H	Slave address	02H
Function code	03H	Function code	03H
Start No. (H)	00H	Data count	06H
Start No. (L)	67H	Lower limit data (H)	00H
Number of data pieces (H)	00H	Lower limit data (L)	00H
Number of data pieces (L)	03H	Upper limit data (H)	03H
CRC (L)	B4H	Upper limit data (L)	E8H
CRC (H)	27H	Decimal point data (H)	00H
		Decimal point data (L)	01H
		CRC (L)	74H
		CRC (H)	35H

<Error check in ASCII mode>

LRC	91H	LRC	09H
-----	-----	-----	-----

Note: Start No. (relative number) is "reference number – 40001".

(Decimal value 103 (= 40104-40001) → hexadecimal value 67H)

Note: Data count means the number of data bytes.

(This is different from the required number of data pieces. In above example, the required number of data pieces is three, and the data count is six.)

Note: The number of data pieces in a message which can be received (transmitted by the unit) at one time is limited (see section 8-4).

### 4. Read analog input data (read input register contents)

Function code: 04 [04H]

This function reads the designated quantity of consecutive analog input data (two bytes: 16 bits) starting from the specified number. The data is divided into high-order eight bits and low-order eight bits, and then arranged in numerical order to form a response message.

A response example is the same as "Function code 03", though the Start No. (relative number) becomes "reference number – 30001".

## 5. Write digital setting (change single coil status)

Function code: 05 [05H]

This function makes the digital setting of specified number the specified status (ON/OFF).

Example: Executing message printing on slave 2

(Setting the digital setting (reference No. 20) of slave 2 to ON)

<RTU mode>

Master → Device		Device → Master (normal)	
Slave address	02H	Slave address	02H
Function code	05H	Function code	05H
Setting No. (H)	00H	Setting No. (H)	00H
Setting No. (L)	13H	Setting No. (L)	13H
Setting status (H)	FFH	Setting status (H)	FFH
Setting status (L)	00H	Setting status (L)	00H
CRC (L)	7DH	CRC (L)	7DH
CRC (H)	CCH	CRC (H)	CCH

<Error check in ASCII mode>

LRC	E7H	LRC	E7H
-----	-----	-----	-----

Note: Normal response is the same as command message.

Note: Setting No. (relative number) is “reference number – 1”.

(Decimal value 19 (= 20-1) → hexadecimal value 13H)

Note: Set “FF00H” to execute.

For the case of key lock and recording ON/OFF, set “0000H” to turn OFF or “FF00H” to turn ON.

Note: When the slave address is set to 0, all the slave devices execute the command, but no response is made from any of them.

## 6. Write analog settings (write to single holding register)

Function code: 06 [06H]

This function changes the analog setting of specified number to the specified value.

Example: Setting CH1 sensor correction value of slave 2 to 20

(Setting the analog setting (reference No. 40111) of slave 2 to "20")

<RTU mode>

Master → Device		Device → Master (normal)	
Slave address	02H	Slave address	02H
Function code	06H	Function code	06H
Setting No. (H)	00H	Setting No. (H)	00H
Setting No. (L)	6EH	Setting No. (L)	6EH
Setting status (H)	00H	Setting status (H)	00H
Setting status (L)	14H	Setting status (L)	14H
CRC (L)	E8H	CRC (L)	E8H
CRC (H)	2BH	CRC (H)	2BH

<Error check in ASCII mode>

LRC	76H	LRC	76H
-----	-----	-----	-----

Note: Normal response is the same as command message.

Note: Setting No. (relative number) is "reference number - 40001".

(Decimal value 110 (= 40111-40001) → hexadecimal value 6EH)

Note: When the slave address is set to 0, all the slave devices execute the command, but no response is made from any of them.

## 7. Loop-back test

Function code: 08 [08H]

Transmission between master and slave is checked, and a response is made according to the specified diagnosis code.

The unit performs "return check" which transmits unaltered received data, and the diagnosis code is fixed to "0000H".

Example: Performing a loop-back test on slave 2

<RTU mode>

Master → Device		Device → Master (normal)	
Slave address	02H	Slave address	02H
Function code	08H	Function code	08H
Diagnosis code (H)	00H	Diagnosis code (H)	00H
Diagnosis code (L)	00H	Diagnosis code (L)	00H
Arbitrary data	*	Received arbitrary data	*
Arbitrary data	*	Received arbitrary data	*
CRC (L)	*	CRC (L)	*
CRC (H)	*	CRC (H)	*

<Error check in ASCII mode>

LRC	*	LRC	*
-----	---	-----	---

## 8. Write multiple analog settings (write to multiple holding registers)

Function code: 16 [10H]

This function changes the designated quantity of analog settings starting from the specified number to the specified value. The data is divided into high-order eight bits and low-order eight bits, and arranged in numerical order to transmit.

Example: Setting CH1 range upper/lower limits and decimal point of slave 2 to "0.0 to 100.0"  
(Setting three analog settings (reference No. 40104 to 40106) of slave 2)

Reference No.	40104	40105	40106
Data	0 (0000H)	1000 (03E8H)	1 (0001H)

<RTU mode>

Master → Device		Device → Master (normal)	
Slave address	02H	Slave address	02H
Function code	10H	Function code	10H
Start No. (H)	00H	Start No. (H)	00H
Start No. (L)	67H	Start No. (L)	67H
Number of data pieces (H)	00H	Number of data pieces (H)	00H
Number of data pieces (L)	03H	Number of data pieces (L)	03H
Data count	06H	CRC (L)	31H
1st data (H)	00H	CRC (H)	E4H
1st data (L)	00H		
2nd data (H)	03H		
2nd data (L)	E8H		
3rd data (H)	00H		
3rd data (L)	01H		
CRC (L)	10H		
CRC (H)	97H		

<Error check in ASCII mode>

LRC	92H	LRC	84H
-----	-----	-----	-----

Note: Start No. (relative number) is "reference number - 40001".

(Decimal value 103 (= 40104-40001) → hexadecimal value 67H)

Note: When the slave address is set to 0, all the slave devices execute the command, but no response is made from any of them.

Note: The number of data pieces in a message which can be transmitted (received by the unit) at one time is limited (see section 8-4).



## 9. Write floating data

Function code: 71 [47H]

This function changes the designated quantity of floating data (floating point data) starting from the specified number to the specified value. The standard MODBUS does not have this function code. A single piece of floating point data is represented by four bytes (32 bits).

Example: Writing data of CH1 and CH2 used for data communications input on slave 1  
(Setting two pieces of floating data (reference No. 50201 and 50202) of slave 1)

Reference No.	50201	50202
Data	1234.5 (44H,9AH,50H,00H)	12.345 (41H,45H,85H,1FH)

<RTU mode>

Slave address	01H
Function code	47H
Data type	00H
Start No. (H)	00H
Start No. (L)	C8H
Number of data pieces (H)	00H
Number of data pieces (L)	02H
Data count	08H
First data (1)	00H
First data (2)	50H
First data (3)	9AH
First data (4)	44H
Next data (1)	1FH
Next data (2)	85H
Next data (3)	45H
Next data (4)	41H
CRC (L)	05H
CRC (H)	ABH

Slave address	01H
Function code	47H
Data type	00H
Start No. (H)	00H
Start No. (L)	C8H
Number of data pieces (H)	00H
Number of data pieces (L)	02H
CRC (L)	04H
CRC (H)	88H

<Error check in ASCII mode>

LRC	8EH
-----	-----

LRC	EEH
-----	-----

Note: Data type is fixed to 00H.

Note: Start No. (relative number) is "reference number - 50001".  
(Decimal value 200 (= 50201-50001) → hexadecimal value C8H)

Note: Data count means the number of data bytes.

(This is different from the number of parameters. In above example, the number of parameters is two, and the data count is eight.)

Note: Transmit the floating point data from LSB.

## 10. Read floating data

Function code: 70 [46H]

This function reads the designated quantity of floating data (floating point data) starting from the specified number. The standard MODBUS does not have this function code. A single piece of floating point data is represented by four bytes (32 bits).

The floating data format conforms to IEEE754.

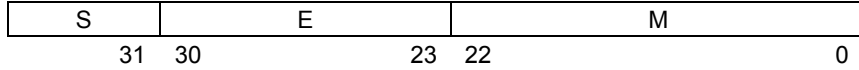

S: Sign bit of fixed-point part

E: Exponential part (8 bits)

M: Fixed-point part (23 bits)

$$\text{Value} = (-1)^S \times 1.M \times 2^{E-127}$$

Example: Reading CH1 and CH2 floating data of slave 1

(Reading two pieces of floating data (reference No. 50101 and 50102) of slave 1)

Reference No.	50101	50102
Data	1234.5 (44H,9AH,50H,00H)	123.45 (42H,F6H,E6H,66H)

<RTU mode>

Master → Device

Slave address	01H
Function code	46H
Data type	00H
Start No. (H)	00H
Start No. (L)	64H
Number of data pieces (H)	00H
Number of data pieces (L)	02H
CRC (L)	C5H
CRC (H)	78H

Device → Master (normal)

Slave address	01H
Function code	46H
Data type	00H
Data count	08H
First data (1)	00H
First data (2)	50H
First data (3)	9AH
First data (4)	44H
Next data (1)	66H
Next data (2)	E6H
Next data (3)	F6H
Next data (4)	42H
CRC (L)	30H
CRC (H)	56H

<Error check in ASCII mode>

LRC	53H
-----	-----

LRC	FFH
-----	-----

Note: Data type is fixed to 00H.

Note: Start No. (relative number) is "reference number – 50001".

(Decimal value 100 (= 50101-50001) → hexadecimal value 64H)

Note: Data count means the number of data bytes.

(This is different from the required number of data pieces. In above example, the required number of data pieces is two, and the data count is eight.)

Note: Transmit the floating point data from LSB.

## 8-6. Response to Abnormal Situation

When a message from the master device contains an error, the following responses will be made.

### 1. No response

Message is ignored and no response is made in the following situations.

- (1) A transmission error (overrun, framing, parity, CRC or LRC) is detected in a message.
- (2) A slave address in a message does not match the receiver address.
- (3) Data interval in a message is too long.  
RTU mode: More than 28-bit time  
ASCII mode: More than one second
- (4) Transmission parameters do not agree.
- (5) A received message exceeds 512 bytes.

Note: When the slave address is "0" for writing functions, message is executed if it contains no error, but no response is made.

### 2. Returning error message

When a message from the master device does not contain an error described in 8-6.1, but any of the following problems occur, a code indicating the error will be returned as "error message".

The format of error message is shown below.

Slave address
Function code + 80H
Error code
CRC (L)
CRC (H)

Function code	Error code
01	81H
02	82H
03	83H
04	84H
05	85H
06	86H
08	88H
16	90H
70	C6H
71	C7H

\* Error code is formed by adding 80H to a function code.

Example: When the function code is 16, the error code becomes 10H (16) + 80H = 90H.

Error codes are shown in the following table.

Error code	Description
01H	Function code error Undefined function code is received.
02H	Relative number (reference number) error Undefined start number or setting number is received.
03H	Error in number of data pieces Any of the following cases: (1) Received function code disagrees with the number of data pieces. <ul style="list-style-type: none"> <li>• “Data count” is not twice the “Number of data pieces” when the function code is “16”</li> <li>• “Data count” is not quadruple the “Number of data pieces” when the function code is “71”</li> <li>• “Data count” disagrees with “Received data count” when the function code is “16” or “71”</li> </ul> (2) Transmission data in response to a received message exceeds the specified number of data pieces. <ul style="list-style-type: none"> <li>• RTU: Up to 120 (up to 60 for floating data)</li> <li>• ASCII: Up to 60</li> </ul>
11H	Out-of-range setting (setting error) Any of the following cases: (1) Undefined range No. (2) Setting (binary) exceeds the specified range (3) Decimal point data is out of the range of “0 to 3” (4) RJ internal is set for a case other than thermocouple input range (5) Burnout is set to other than None for the voltage (V) input range
12H	Setting disabled When a setting message is received in any of the following situations: <ul style="list-style-type: none"> <li>• Parameter setting for multiple channels is required when performing parameter setting on each channel</li> <li>• Parameter setting of unused optional function is required (A “0” response is transmitted for a read message.)</li> <li>• Setting on the unit or via Web window is in progress</li> <li>• Setting contents are being registered (Registration process, which takes about one second, starts three seconds after receiving the last frame of setting.)</li> <li>• Setting is performed on an item which is not available for setting during recording</li> </ul>

## 8-7. Title Printing (Message Printing 2) Function

Arbitrary characters can be printed on the chart of the unit through communications.

<Printing specifications>

	SR200	SR100
Number of printed characters	Max. 72	Max. 40
Character type	Alphanumeric characters (upper/lower cases), symbols and katakana (When using katakana, 8-bit data must be used for communication.)	
Color	Selectable from six colors: red, black, blue, green, brown and purple (only for multi-point type)	
Feed specification	Specify whether to perform printing by interrupting trace printing, or perform printing on trace printing	

<Procedure>

- (1) The master device transmits the information of color, feed specification and printing contents to the unit. (See reference numbers: 48001 to 48038.)
- (2) The master device transmits an execution message to the unit. (See reference number 20 and section 8-5.5.)

Note: When step (2) is executed without taking step (1), the previously printed contents will be printed again. Nothing will be printed if message printing has never been executed.

## 8-8. Data Communications Input

Using this function, the “data” transmitted from the master device through communication is recorded in the same manner as measured data. For the transmitted data, operations including recording, calculation (for alarm etc.) and communication output are performed just like measured data.

<Procedure>

- (1) The master device transmits a calculation number and recording range (upper/lower limits) of the channel for recording data communications input in advance to the unit. Once these items have been transmitted, there is no need of transmitting them again until a change of recording range, etc. becomes necessary. In this case, the range and scale settings become invalid and the above recording range becomes effective for recording (see reference numbers: 40165 to 42500).
- (2) The master device transmits the data to be recorded. (Reference numbers: 49001 to 49048, or 50201 to 50224 for floating data)
- (3) The data is updated every time transmission from the master device occurs.

Note: After the power is turned on, recording data is invalid (display: “- - -”) until the first data is transmitted from the master device.

Note: Even if the range is set for the channel to be recorded, measured data is replaced with the input data through communications.

## 8-9. Reference Table

### 1. Digital parameters

R/W ... R: READ, W: WRITE

Reference No.	Applicable function code	R/W	Description	Details
01	01 05	R W	Key lock	0 (0000h) = UNLOCK (key lock disabled) 1 (FF00h) = LOCK (key lock enabled) The value in () is for the case of function code 05. Error code: 01H, 02H, 03H, 11H, 12H
10	01 05	R W	Message printing 1 (1) execute	0 (0000h) = Not executed (finished) 1 (FF00h) = Executing (started) The value in () is for the case of function code 05. Error code: 01H, 02H, 03H, 11H, 12H
11	01 05	R W	Message printing 1 (2) execute	0 (0000h) = Not executed (finished) 1 (FF00h) = Executing (started) The value in () is for the case of function code 05. Error code: 01H, 02H, 03H, 11H, 12H
12	01 05	R W	Message printing 1 (3) execute	0 (0000h) = Not executed (finished) 1 (FF00h) = Executing (started) The value in () is for the case of function code 05. Error code: 01H, 02H, 03H, 11H, 12H
13	01 05	R W	Message printing 1 (4) execute	0 (0000h) = Not executed (finished) 1 (FF00h) = Executing (started) The value in () is for the case of function code 05. Error code: 01H, 02H, 03H, 11H, 12H
14	01 05	R W	Message printing 1 (5) execute	0 (0000h) = Not executed (finished) 1 (FF00h) = Executing (started) The value in () is for the case of function code 05. Error code: 01H, 02H, 03H, 11H, 12H
15	01 05	R W	Message printing 1 (6) execute	0 (0000h) = Not executed (finished) 1 (FF00h) = Executing (started) The value in () is for the case of function code 05. Error code: 01H, 02H, 03H, 11H, 12H
16	01 05	R W	Message printing 1 (7) execute	0 (0000h) = Not executed (finished) 1 (FF00h) = Executing (started) The value in () is for the case of function code 05. Error code: 01H, 02H, 03H, 11H, 12H
17	01 05	R W	Recording ON/OFF	0 (0000h) = Recording OFF 1 (FF00h) = Recording ON The value in () is for the case of function code 05. Error code: 01H, 02H, 03H, 11H, 12H
18	01 05	R W	Feed execute	0 (0000h) = Not executed (finished) 1 (FF00h) = Executing (started) The value in () is for the case of function code 05. Error code: 01H, 02H, 03H, 11H, 12H
19	01 05	R W	List printing 1 execute	0 (0000h) = Not executed (finished) 1 (FF00h) = Executing (started) The value in () is for the case of function code 05. Error code: 01H, 02H, 03H, 11H, 12H
20	01 05	R W	Title printing execute (Message printing 2 execute)	0 (0000h) = Not executed (finished) 1 (FF00h) = Executing (started) The value in () is for the case of function code 05. Error code: 01H, 02H, 03H, 11H, 12H

Reference No.	Applicable function code	R/W	Description	Details
21	01 05	R W	Data printing execute	0 (0000h) = Not executed (finished) 1 (FF00h) = Executing (started) The value in () is for the case of function code 05. Error code: 01H, 02H, 03H, 11H, 12H
22	01 05	R W	Recording to SD card ON/OFF	0 (0000h) = Recording OFF 1 (FF00h) = Recording ON The value in () is for the case of function code 05. Error code: 01H, 02H, 03H, 11H, 12H
26	01 05	R W	Fast dot printing *only for multi-point type	0 (0000h) = Standard (approx. 5sec/point) 1 (FF00h) = Fast (approx.. 2.5sec/point) The value in () is for the case of function code 05. Error code: 01H, 02H, 03H, 11H, 12H
27	01 05	R W	Time axis synchronization ON/OFF *only for pen type	0 (0000h) = OFF 1 (FF00h) = ON When inside the () is 05 Error code : 01H,02H, 03H, 11H,12H
33	01 05	R W	List printing 1 execute	0 (0000h) = Not executed (finished) 1 (FF00h) = Executing (started) The value in () is for the case of function code 05. Error code: 01H, 02H, 03H, 11H, 12H
34	01 05	R W	List printing 2 execute	0 (0000h) = Not executed (finished) 1 (FF00h) = Executing (started) The value in () is for the case of function code 05. Error code: 01H, 02H, 03H, 11H, 12H
35	01 05	R W	List printing 3 execute	0 (0000h) = Not executed (finished) 1 (FF00h) = Executing (started) The value in () is for the case of function code 05. Error code: 01H, 02H, 03H, 11H, 12H
49	01 05	R W	Alarm relay coil magnetic excitation state *only for pen type	0 (0000h) = non-excited state 1 (FF00h) = magnetic excitation When inside the () is 05 Error code: 01H, 02H, 03H,11H,12H
61	01 05	R W	Message printing 1 (8) execute	0 (0000h) = Not executed (finished) 1 (FF00h) = Executing (started) The value in () is for the case of function code 05. Error code: 01H, 02H, 03H, 11H, 12H
62	01 05	R W	Message printing 1 (9) execute	0 (0000h) = Not executed (finished) 1 (FF00h) = Executing (started) The value in () is for the case of function code 05. Error code: 01H, 02H, 03H, 11H, 12H
63	01 05	R W	Message printing 1 (10) execute	0 (0000h) = Not executed (finished) 1 (FF00h) = Executing (started) The value in () is for the case of function code 05. Error code: 01H, 02H, 03H, 11H, 12H
64	01 05	R W	Message printing 1 (11) execute	0 (0000h) = Not executed (finished) 1 (FF00h) = Executing (started) The value in () is for the case of function code 05. Error code: 01H, 02H, 03H, 11H, 12H
65	01 05	R W	Message printing 1 (12) execute	0 (0000h) = Not executed (finished) 1 (FF00h) = Executing (started) The value in () is for the case of function code 05. Error code: 01H, 02H, 03H, 11H, 12H

Reference No.	Applicable function code	R/W	Description	Details
66	01 05	R W	Message printing 1 (13) execute	0 (0000h) = Not executed (finished) 1 (FF00h) = Executing (started) The value in () is for the case of function code 05. Error code: 01H, 02H, 03H, 11H, 12H
67	01 05	R W	Message printing 1 (14) execute	0 (0000h) = Not executed (finished) 1 (FF00h) = Executing (started) The value in () is for the case of function code 05. Error code: 01H, 02H, 03H, 11H, 12H
68	01 05	R W	Message printing 1 (15) execute	0 (0000h) = Not executed (finished) 1 (FF00h) = Executing (started) The value in () is for the case of function code 05. Error code: 01H, 02H, 03H, 11H, 12H
69	01 05	R W	Message printing 1 (16) execute	0 (0000h) = Not executed (finished) 1 (FF00h) = Executing (started) The value in () is for the case of function code 05. Error code: 01H, 02H, 03H, 11H, 12H
70	01 05	R W	Message printing 1 (17) execute	0 (0000h) = Not executed (finished) 1 (FF00h) = Executing (started) The value in () is for the case of function code 05. Error code: 01H, 02H, 03H, 11H, 12H
71	01 05	R W	Message printing 1 (18) execute	0 (0000h) = Not executed (finished) 1 (FF00h) = Executing (started) The value in () is for the case of function code 05. Error code: 01H, 02H, 03H, 11H, 12H
72	01 05	R W	Message printing 1 (19) execute	0 (0000h) = Not executed (finished) 1 (FF00h) = Executing (started) The value in () is for the case of function code 05. Error code: 01H, 02H, 03H, 11H, 12H
73	01 05	R W	Message printing 1 (20) execute	0 (0000h) = Not executed (finished) 1 (FF00h) = Executing (started) The value in () is for the case of function code 05. Error code: 01H, 02H, 03H, 11H, 12H
95	01 05	R W	SNTP time setting execute	0 (0000h) = Not executed (finished) 1 (FF00h) = Executing (started) The value in () is for the case of function code 05. Error code: 01H, 02H, 03H, 11H, 12H



## 2. Digital input data

R/W ... R: READ

Reference No.	Applicable function code	R/W	Description	Details
10009 10010 10011 10012 10013 10014 10015 10016 10017 10018 10019 10020 10021 10022 10023 10024 10025 10026 10027 10028	02	R	Remote contact 1 status Remote contact 2 status Remote contact 3 status Remote contact 4 status Remote contact 5 status Remote contact 6 status Remote contact 7 status Remote contact 8 status Remote contact 9 status Remote contact 10 status Remote contact 11 status Remote contact 12 status Remote contact 13 status Remote contact 14 status Remote contact 15 status Remote contact 16 status Remote contact 17 status Remote contact 18 status Remote contact 19 status Remote contact 20 status	Remote contact input status 0: OFF 1: ON
10051	02	R	Chart end status	0: Chart enabled 1: Char end occurred
10052	02	R	Input disconnection	0: No input disconnection 1: Input disconnection occurred
10053	02	R	SD card capacity low	0: Capacity is not low 1: Capacity is low (capacity 3% or less)
10054	02	R	Backup battery low level	0: Battery is not low level 1: Battery is low level (voltage 2V or less)
10055	02	R	System error	0: No system error 1: System error occurred
10101 10102	02	R	CH1 status 1	Status represented by 2 bits 00: Measured value 01: Calculation data 10: Communication input data Error code: 01H, 02H, 03H
10105 10106 10107 10108	02	R	CH1 status 2	Status represented by 4 bits 0000: Normal data 0001: + Over range 0010: - Over range 0100: Burnout 1000: Invalid data (initialization or data collection in progress, or range not set) Error code: 01H, 02H, 03H
10109 10110 10111 10112	02	R	CH1 alarm level 1 CH1 alarm level 2 CH1 alarm level 3 CH1 alarm level 4 Activation status	0: Alarm not activated 1: Alarm activated Error code: 01H, 02H, 03H
10117 10118	02	R	CH2 status 1	Same as CH1

Reference No.	Applicable function code	R/W	Description	Details
10121 to 10124	02	R	CH2 status 2	Same as CH1
10125 to 10128	02	R	CH2 alarm level 1 to 4 activation status	Same as CH1
10133 10134	02	R	CH3 status 1	Same as CH1
10137 to 10140	02	R	CH3 status 2	Same as CH1
10141 to 10144	02	R	CH3 alarm level 1 to 4 activation status	Same as CH1
10149 10150	02	R	CH4 status 1	Same as CH1
10153 to 10156	02	R	CH4 status 2	Same as CH1
10157 to 10160	02	R	CH4 alarm level 1 to 4 activation status	Same as CH1
10165 10166	02	R	CH5 status 1	Same as CH1
10169 to 10172	02	R	CH5 status 2	Same as CH1
10173 to 10177	02	R	CH5 alarm level 1 to 4 activation status	Same as CH1
10181 10182	02	R	CH6 status 1	Same as CH1
10185 to 10188	02	R	CH6 status 2	Same as CH1
10189 to 10192	02	R	CH6 alarm level 1 to 4 activation status	Same as CH1
10197 10198	02	R	CH7 status 1	Same as CH1
10201 to 10204	02	R	CH7 status 2	Same as CH1
10205 to 10208	02	R	CH7 alarm level 1 to 4 activation status	Same as CH1
10213 10214	02	R	CH8 status 1	Same as CH1
10217 to 10220	02	R	CH8 status 2	Same as CH1

Reference No.	Applicable function code	R/W	Description	Details
10221 to 10224	02	R	CH8 alarm level 1 to 4 activation status	Same as CH1
10229 10230	02	R	CH9 status 1	Same as CH1
10233 to 10236	02	R	CH9 status 2	Same as CH1
10237 to 10240	02	R	CH9 alarm level 1 to 4 activation status	Same as CH1
10245 10246	02	R	CH10 status 1	Same as CH1
10249 to 10252	02	R	CH10 status 2	Same as CH1
10253 to 10256	02	R	CH10 alarm level 1 to 4 activation status	Same as CH1
10261 10262	02	R	CH11 status 1	Same as CH1
10265 to 10268	02	R	CH11 status 2	Same as CH1
10269 to 10272	02	R	CH11 alarm level 1 to 4 activation status	Same as CH1
10277 10278	02	R	CH12 status 1	Same as CH1
10281 to 10284	02	R	CH12 status 2	Same as CH1
10285 to 10288	02	R	CH12 alarm level 1 to 4 activation status	Same as CH1
10293 10294	02	R	CH13 status 1	Same as CH1
10297 to 10300	02	R	CH13 status 2	Same as CH1
10301 to 10304	02	R	CH13 alarm level 1 to 4 activation status	Same as CH1
10309 10310	02	R	CH14 status 1	Same as CH1
10313 to 10316	02	R	CH14 status 2	Same as CH1
10317 to 10320	02	R	CH14 alarm level 1 to 4 activation status	Same as CH1
10325 10326	02	R	CH15 status 1	Same as CH1

Reference No.	Applicable function code	R/W	Description	Details
10329 to 10332	02	R	CH15 status 2	Same as CH1
10333 to 10336	02	R	CH15 alarm level 1 to 4 activation status	Same as CH1
10341 to 10342	02	R	CH16 status 1	Same as CH1
10345 to 10348	02	R	CH16 status 2	Same as CH1
10349 to 10352	02	R	CH16 alarm level 1 to 4 activation status	Same as CH1
10357 to 10358	02	R	CH17 status 1	Same as CH1
10361 to 10364	02	R	CH17 status 2	Same as CH1
10365 to 10368	02	R	CH17 alarm level 1 to 4 activation status	Same as CH1
10373 to 10374	02	R	CH18 status 1	Same as CH1
10377 to 10380	02	R	CH18 status 2	Same as CH1
10381 to 10384	02	R	CH18 alarm level 1 to 4 activation status	Same as CH1
10389 to 10390	02	R	CH19 status 1	Same as CH1
10393 to 10396	02	R	CH19 status 2	Same as CH1
10397 to 10400	02	R	CH19 alarm level 1 to 4 activation status	Same as CH1
10405 to 10406	02	R	CH20 status 1	Same as CH1
10409 to 10412	02	R	CH20 status 2	Same as CH1
10413 to 10416	02	R	CH20 alarm level 1 to 4 activation status	Same as CH1
10421 to 10422	02	R	CH21 status 1	Same as CH1
10425 to 10428	02	R	CH21 status 2	Same as CH1

Reference No.	Applicable function code	R/W	Description	Details
10429 to 10432	02	R	CH21 alarm level 1 to 4 activation status	Same as CH1
10437 10438	02	R	CH22 status 1	Same as CH1
10441 to 10444	02	R	CH22 status 2	Same as CH1
10445 to 10448	02	R	CH22 alarm level 1 to 4 activation status	Same as CH1
10453 10454	02	R	CH23 status 1	Same as CH1
10457 to 10460	02	R	CH23 status 2	Same as CH1
10461 to 10464	02	R	CH23 alarm level 1 to 4 activation status	Same as CH1
10469 10470	02	R	CH24 status 1	Same as CH1
10473 to 10476	02	R	CH24 status 2	Same as CH1
10477 to 10480	02	R	CH24 alarm level 1 to 4 activation status	Same as CH1

### 3. Analog input data

1) Reading device information

R/W ... R: READ

Reference No.	Applicable function code	R/W	Description	Details
30001	04	R	Device name character 1, 2	ASCII "SR" (type) Error code: 01H, 02H, 03H, 12H
30002	04	R	Device name character 3, 4	ASCII 1st digit: (type) "1": Front size 144 x 144 "2": Front size 288 x 288 ASCII 2nd digit: Input points "0": 6 points, pen type "1": 12 points "2": 24 points Error code: 01H, 02H, 03H, 12H
30003	04	R	Device name character 5, 6	ASCII 1st digit: Input points "6": 6 points "2": 12 points "4": 24 points "1": one pen type "2": two pen type "3": three pen type "4": four pen type ASCII 2nd digit: power supply "A": 100 to 240V AC "D": 24V AC/24V DC Error code: 01H, 02H, 03H, 12H
30004	04	R	Device name character 7, 8	ASCII 1st digit: Communication type "N": None "E": Ethernet "R": COM1_RS232C "A": COM1_RS422A/485 "Q": COM1_RS232C + COM2_RS485 "C": COM1_RS422A/485 + COM2_RS485 "G": COM1_RS422A/485 + COM2_RS485 + Ethernet ASCII 2nd digit: Alarm output + remote contact "0": None "2": 2 points of mechanical relay 'a' contact output "4": 4 points of mechanical relay 'c' contact output + 5 points of remote contact input "A": 6 points of mechanical relay 'a' contact output + 5 points of remote contact input "8": 8 points of mechanical relay 'c' contact output + 10 points of remote contact input "B": 12 points of mechanical relay 'a' contact output + 10 points of remote contact input "F": 16 points of mechanical relay 'c' contact output + 20 points of remote contact input "D": 24 points of mechanical relay 'a' contact output + 20 points of remote contact input Error code: 01H, 02H, 03H, 12H
30005	04	R	Device name character 9, 10	ASCII 1st digit: Additional treatment "0": None *For communication, reading of additional treatment is fixed to "0". (Actual model may be different.) ASCII 2nd digit: 1st digit of OP/SP code Depends on the specifications Error code: 01H, 02H, 03H, 12H

Reference No.	Applicable function code	R/W	Description	Details
30006	04	R	Device name character 11, 12	ASCII 1st digit: 2nd digit of OP/SP code Depends on the specifications ASCII 2nd digit: 3rd digit of OP/SP code Depends on the specifications Error code: 01H, 02H, 03H, 12H
30009	04	R	ROM version (Application CPU)	Value of x 1000 (eg: 1000: 1.000) Error code: 01H, 02H, 03H, 12H
30010	04	R	ROM version (Printer CPU)	Value of x 1000 (eg: 1000: 1.000) Error code: 01H, 02H, 03H, 12H
30011	04	R	ROM version (Preamplifier 1)	Value of x 1000 (eg: 1000: 1.000) Error code: 01H, 02H, 03H, 12H
30012	04	R	ROM version (Preamplifier 2) *for multi-point type ----- ROM version (Servo CPU 1) *only for pen type	Value of x 1000 (eg: 1000: 1.000) Error code: 01H, 02H, 03H, 12H
30013	04	R	ROM version (Servo CPU 2) *only for pen type	Value of x 1000 (eg: 1000: 1.000) Error code: 01H, 02H, 03H, 12H
30014	04	R	ROM version (Servo CPU 3) *only for pen type	Value of x 1000 (eg: 1000: 1.000) Error code: 01H, 02H, 03H, 12H
30015	04	R	ROM version (Servo CPU 4) *only for pen type	Value of x 1000 (eg: 1000: 1.000) Error code: 01H, 02H, 03H, 12H
30017	04	R	Input points	Number of channels Error code: 01H, 02H, 03H, 12H
30025	04	R	Alarm output points	0: None, 2: 2 points, 4: 4 points, 6: 6 points, 8: 8 points, 12: 12 points, 16: 16 points, 24: 24 points Error code: 01H, 02H, 03H, 12H
30026	04	R	Remote contact input points	0: None, 5: 5 points, 10: 10 points, 20: 20 points Error code: 01H, 02H, 03H, 12H
30027	04	R	Communication type	0: None 1: COM1_RS232C 2: COM1_RS422A/485 3: COM1_RS232C + COM2_RS485 4: COM1_RS422A/485 + COM2_RS485 5: COM1_RS422A/485 + COM2_RS485 + Ethernet 6: Ethernet Error code: 01H, 02H, 03H, 12H
30028	04	R	Option information	0: None Error code: 01H, 02H, 03H, 12H

## 2) Reading measured data

R/W ... R: READ

Reference No.	Applicable function code	R/W	Description	Details
30101	04	R	CH1 data	DATA: -30000 to 30000 -32768: 16-bit expression over -32768: + Binary expression over 32767: + Over range -32767: - over range 32766: Burnout -32766: Invalid data 32764: Calculation error Error code: 01H, 02H, 03H, 12H
30102	04	R	CH1 decimal point	0 to 3 Error code: 01H, 02H, 03H, 12H
30103	04	R	CH2 data	Same as CH1
30104	04	R	CH2 decimal point	Same as CH1
30105	04	R	CH3 data	Same as CH1
30106	04	R	CH3 decimal point	Same as CH1
30107	04	R	CH4 data	Same as CH1
30108	04	R	CH4 decimal point	Same as CH1
30109	04	R	CH5 data	Same as CH1
30110	04	R	CH5 decimal point	Same as CH1
30111	04	R	CH6 data	Same as CH1
30112	04	R	CH6 decimal point	Same as CH1
30113	04	R	CH7 data	Same as CH1
30114	04	R	CH7 decimal point	Same as CH1
30115	04	R	CH8 data	Same as CH1
30116	04	R	CH8 decimal point	Same as CH1
30117	04	R	CH9 data	Same as CH1
30118	04	R	CH9 decimal point	Same as CH1
30119	04	R	CH10 data	Same as CH1
30120	04	R	CH10 decimal point	Same as CH1
30121	04	R	CH11 data	Same as CH1
30122	04	R	CH11 decimal point	Same as CH1
30123	04	R	CH12 data	Same as CH1
30124	04	R	CH12 decimal point	Same as CH1
30125	04	R	CH13 data	Same as CH1
30126	04	R	CH13 decimal point	Same as CH1
30127	04	R	CH14 data	Same as CH1
30128	04	R	CH14 decimal point	Same as CH1
30129	04	R	CH15 data	Same as CH1
30130	04	R	CH15 decimal point	Same as CH1
30131	04	R	CH16 data	Same as CH1
30132	04	R	CH16 decimal point	Same as CH1
30133	04	R	CH17 data	Same as CH1
30134	04	R	CH17 decimal point	Same as CH1
30135	04	R	CH18 data	Same as CH1
30136	04	R	CH18 decimal point	Same as CH1
30137	04	R	CH19 data	Same as CH1
30138	04	R	CH19 decimal point	Same as CH1
30139	04	R	CH20 data	Same as CH1
30140	04	R	CH20 decimal point	Same as CH1
30141	04	R	CH21 data	Same as CH1
30142	04	R	CH21 decimal point	Same as CH1



Reference No.	Applicable function code	R/W	Description	Details
30143	04	R	CH22 data	Same as CH1
30144	04	R	CH22 decimal point	Same as CH1
30145	04	R	CH23 data	Same as CH1
30146	04	R	CH23 decimal point	Same as CH1
30147	04	R	CH24 data	Same as CH1
30148	04	R	CH24 decimal point	Same as CH1

## \* About status information

MSB (15)		(11)				(7)				(4)		LSB (0)
0	AZI	0	0	EV4	EV3	EV2	EV1	ERR	BURN	OF	UF	DP

AZI : Wind data 0 (Normal data)/1 (Wind data)  
 EV1 to EV4 : Each alarm status 0 (Not activated)/1 (Activated)  
 ERR : Input status 0 (Normal)/1 (Abnormal)  
 BURN : Sensor disconnection 0 (Not occurred)/1 (Occurred)  
 OF : Over range 0 (Not occurred)/1 (Occurred)  
 UF : Under range 0 (Not occurred)/1 (Occurred)  
 DP : Decimal point position of data|0|0|0|0|: 0, |0|0|0|1|: 1, |0|0|1|0|: 2, |0|0|1|1|: 3

## 4. Analog parameters

### 1) Parameters common to channels (1)

R/W ... R: READ, W: WRITE

Reference No.	Applicable function code	R/W	Description	Details
40001	03 06 16	R W W	Date and time setting (year)	ASCII 2 digits (1st digit can use space code) 00 to 99: 2000 to 2099 Error code: 01H, 02H, 03H, 12H
40002	03 06 16	R W W	Date and time setting (month)	ASCII 2 digits (1st digit can use space code) 01 to 12 Error code: 01H, 02H, 03H, 12H
40003	03 06 16	R W W	Date and time setting (day)	ASCII 2 digits (1st digit can use space code) 01 to 31 Error code: 01H, 02H, 03H, 12H
40004	03 06 16	R W W	Date and time setting (hour)	ASCII 2 digits (1st digit can use space code) 00 to 23 Error code: 01H, 02H, 03H, 12H
40005	03 06 16	R W W	Date and time setting (minute)	ASCII 2 digits (1st digit can use space code) 00 to 59 Error code: 01H, 02H, 03H, 12H
40006	03 06 16	R W W	Date and time setting (second)	ASCII 2 digits (1st digit can use space code) 00 to 59 Error code: 01H, 02H, 03H, 12H
40007	03	R	First 2 digits of year	ASCII 2 digits Fixed to "20" Error code: 01H, 02H, 03H, 12H
40008	03	R	Last 2 digits of year	ASCII 2 digits 00 to 99 Error code: 01H, 02H, 03H, 12H
40011	03 06 16	R W W	DipSW1 High-order 16 bits	Bit31 to Bit16  Error code: 01H, 02H, 03H, 12H
40012	03 06 16	R W W	DipSW1 Low-order 16 bits	Bit15 to Bit0  Error code: 01H, 02H, 03H, 12H
40017	03	R	Executing chart Speed number	1 to 3 Only reading enabled Error code: 01H, 02H, 03H, 12H
40018	03 06 16	R W W	Dot printing interval * for multi-point type  Time axis synchronization (POC) * for pen type	0: 5sec, 1: 2.5sec, 2: Linked to chart speed Error code: 01H, 02H, 03H, 12H  0: Time axis synchronization OFF 1: Time axis synchronization ON Error code: 01H, 02H, 03H, 12H
40019	03 06 16	R W W	Chart Speed 1	1 to 1500 [mm/H] -125: 12.5 [mm/H] Error code: 01H, 02H, 03H, 12H
40020	03	R	Chart Speed 1 unit * pen type only	0: (mm/H) 1: (mm/M) Error code: 01H, 02H, 03H, 12H
40022	03 06 16	R W W	Chart Speed 2	1 to 1500 [mm/H] -125: 12.5 [mm/H] Error code: 01H, 02H, 03H, 12H

Reference No.	Applicable function code	R/W	Description	Details
40023	03	R	Chart Speed 2 unit *pen type only	0: (mm/H) 1: (mm/M) Error code: 01H, 02H, 03H, 12H
40025	03 06 16	R W W	Chart Speed 3	1 to 1500 [mm/H] -125: 12.5 [mm/H] Error code: 01H, 02H, 03H, 12H
40026	03	R	Chart Speed 3 unit * pen type only	0: (mm/H) 1: (mm/M) Error code: 01H, 02H, 03H, 12H
40034	03 06 16	R W W	Data interval Interval (hour)	ASCII 2 digits (1 <sup>st</sup> digit can use space code) 00 to 24 Error code: 01H, 02H, 03H, 12H
40035	03 06 16	R W W	Data interval Interval (minute)	ASCII 2 digits (1 <sup>st</sup> digit can use space code) 00 to 59 Error code: 01H, 02H, 03H, 12H
40036	03 06 16	R W W	Data interval Start time (hour)	ASCII 2 digits (1 <sup>st</sup> digit can use space code) 00 to 23 Error code: 01H, 02H, 03H, 12H
40037	03 06 16	R W W	Data interval Start time (minute)	ASCII 2 digits (1 <sup>st</sup> digit can use space code) 00 to 59 Error code: 01H, 02H, 03H, 12H
40049	03 06 16	R W W	Recording format type	0: Standard, 1: Automatic range-shift (normal), 2: Compressed/expanded printing, 3: Zone printing, 4: Automatic range-shift (Overlap) Error code: 01H, 02H, 03H, 12H
40050	03 06 16	R W W	Zone printing Number of areas	2 (SR100) 2 to 4 (SR200) Error code: 01H, 02H, 03H, 12H
40051	03 06 16	R W W	Zone printing 1 <sup>st</sup> area CH1	ASCII 2 digits (1 <sup>st</sup> digit can use space code) 01 to the number of channels, 00H: No setting Error code: 01H, 02H, 03H, 12H
40052	03 06 16	R W W	Zone printing 1 <sup>st</sup> area division 1	0: No setting, 1: /, 2: - Error code: 01H, 02H, 03H, 12H
40053	03 06 16	R W W	Zone printing 1 <sup>st</sup> area CH2	ASCII 2 digits (1 <sup>st</sup> digit can use space code) 01 to the number of channels, 00H: No setting Error code: 01H, 02H, 03H, 12H
40054	03 06 16	R W W	Zone printing 1 <sup>st</sup> area division 2	0: No setting, 1: /, 2: - Error code: 01H, 02H, 03H, 12H
40055	03 06 16	R W W	Zone printing 1 <sup>st</sup> area CH3	ASCII 2 digits (1 <sup>st</sup> digit can use space code) 01 to the number of channels, 00H: No setting Error code: 01H, 02H, 03H, 12H
40056	03 06 16	R W W	Zone printing 2 <sup>nd</sup> area CH1	ASCII 2 digits (1 <sup>st</sup> digit can use space code) 01 to the number of channels, 00H: No setting Error code: 01H, 02H, 03H, 12H
40057	03 06 16	R W W	Zone printing 2 <sup>nd</sup> area division 1	0: No setting, 1: /, 2: - Error code: 01H, 02H, 03H, 12H
40058	03 06 16	R W W	Zone printing 2 <sup>nd</sup> area CH2	ASCII 2 digits (1 <sup>st</sup> digit can use space code) 01 to the number of channels, 00H: No setting Error code: 01H, 02H, 03H, 12H

Reference No.	Applicable function code	R/W	Description	Details
40059	03 06 16	R W W	Zone printing 2 <sup>nd</sup> area division 2	0: No setting, 1: /, 2: - Error code: 01H, 02H, 03H, 12H
40060	03 06 16	R W W	Zone printing 2 <sup>nd</sup> area CH3	ASCII 2 digits (1 <sup>st</sup> digit can use space code) 01 to the number of channels, 00H: No setting Error code: 01H, 02H, 03H, 12H
40061	03 06 16	R W W	Zone printing 3 <sup>rd</sup> area CH1	ASCII 2 digits (1 <sup>st</sup> digit can use space code) 01 to the number of channels, 00H: No setting Error code: 01H, 02H, 03H, 12H
40062	03 06 16	R W W	Zone printing 3 <sup>rd</sup> area division 1	0: No setting, 1: /, 2: - Error code: 01H, 02H, 03H, 12H
40063	03 06 16	R W W	Zone printing 3 <sup>rd</sup> area CH2	ASCII 2 digits (1 <sup>st</sup> digit can use space code) 01 to the number of channels, 00H: No setting Error code: 01H, 02H, 03H, 12H
40064	03 06 16	R W W	Zone printing 3 <sup>rd</sup> area division 2	0: No setting, 1: /, 2: - Error code: 01H, 02H, 03H, 12H
40065	03 06 16	R W W	Zone printing 3 <sup>rd</sup> area CH3	ASCII 2 digits (1 <sup>st</sup> digit can use space code) 01 to the number of channels, 00H: No setting Error code: 01H, 02H, 03H, 12H
40066	03 06 16	R W W	Zone printing 4 <sup>th</sup> area CH1	ASCII 2 digits (1 <sup>st</sup> digit can use space code) 01 to the number of channels, 00H: No setting Error code: 01H, 02H, 03H, 12H
40067	03 06 16	R W W	Zone printing 4 <sup>th</sup> area division 1	0: No setting, 1: /, 2: - Error code: 01H, 02H, 03H, 12H
40068	03 06 16	R W W	Zone printing 4 <sup>th</sup> area CH2	ASCII 2 digits (1 <sup>st</sup> digit can use space code) 01 to the number of channels, 00H: No setting Error code: 01H, 02H, 03H, 12H
40069	03 06 16	R W W	Zone printing 4 <sup>th</sup> area division 2	0: No setting, 1: /, 2: - Error code: 01H, 02H, 03H, 12H
40070	03 06 16	R W W	Zone printing 4 <sup>th</sup> area CH3	ASCII 2 digits (1 <sup>st</sup> digit can use space code) 01 to the number of channels, 00H: No setting Error code: 01H, 02H, 03H, 12H
40073	03 06 16	R W W	Power frequency * pen type only	1:50Hz, 2: 60Hz Error code: 01H, 02H, 03H, 12H
40074	03 06 16	R W W	Filter (pop noise) * pen type only	0 to 10 Error code: 0H,02H,03H, 12H
40090	03 06 16	R W W	Display mode	1: 1CH, 2: 1CH + Bar, 3: 6CH 4: 12CH, 5: 24CH, 6: 2CH, 7: 2Ch + Bar 8: 3CH, 9: 3CH + Bar, 10: 4CH 11: 4CH + Bar, 12: pointer, 13: 6CH + Tag Error code: 01H, 02H, 03H, 12H
40091	03 06 16	R W W	Unit-tag switching	0: Unit, 1: Tag, Unit and tag Error code: 01H, 02H, 03H, 12H
40092	03 06 16	R W W	Display CH Manual-auto switching	0: Manual, 1: Automatic Error code: 01H, 02H, 03H, 12H

Reference No.	Applicable function code	R/W	Description	Details
40093	03 06 16	R W W	CH update interval	0: Linked to dot printing, 1: 1sec, 2: 2sec, 3: 3sec, 4: 5sec, 5: 10sec, 6: 30sec Error code: 01H, 02H, 03H, 12H
40094	03 06 16	R W W	LCD backlight	0: Always ON, 1: Automatic Error code: 01H, 02H, 03H, 12H
40095	03 06 16	R W W	LCD backlight Brightness	1 (dark) to 5 (light) Error code: 01H, 02H, 03H, 12H
40096	03 06 16	R W W	Chart illumination ON/OFF	0: Always ON, 1: OFF, 2: Automatic Error code: 01H, 02H, 03H, 12H
40097	03 06 16	R W W	Chart illumination Brightness	0: OFF 1 (dark) to 5 (light) Error code: 01H, 02H, 03H, 12H
40098	03 06 16	R W W	Display order setting ON/OFF	0: OFF, 1: ON Error code: 01H, 02H, 03H, 12H
40099	03 06 16	R W W	Display contents update interval *pen type only	1: 0.1, 2: 0.2, 3: 0.5, 4: 1 (sec.) Error code: 01H, 02H, 03H, 12H

2) Programming parameters per channel

Note: Writing multiple parameters across two or more channels will constitute an error (error code: 12H).

R/W ... R: READ, W: WRITE

Reference No.	Applicable function code	R/W	Description	Details
40102	03 06 16	R W W	CH1 range No.	ASCII 2 digits (1st digit can use space code) 00H: No setting Error code: 01H, 02H, 03H, 11H, 12H
40103	03 06 16	R W W	CH1 RJ internal/external	0: External, 1: Internal (Fixed to External except for thermocouple input) Error code: 01H, 02H, 03H, 11H, 12H
40104	03 06 16	R W W	CH1 range lower limit	-30000 to 30000 (Up to 9 digits including upper and lower limits and signs) Error code: 01H, 02H, 03H, 11H, 12H
40105	03 06 16	R W W	CH1 range upper limit	-30000 to 30000 (Up to 9 digits including upper and lower limits and signs) Error code: 01H, 02H, 03H, 11H, 12H
40106	03 06 16	R W W	CH1 range decimal point	Decimal point position of the range 0 to 3 (Both range upper and lower limits use the same decimal point position.) Error code: 01H, 02H, 03H, 11H, 12H
40107	03 06 16	R W W	CH1 scale lower limit	-30000 to 30000 Error code: 01H, 02H, 03H, 11H, 12H
40108	03 06 16	R W W	CH1 scale upper limit	-30000 to 30000 Error code: 01H, 02H, 03H, 11H, 12H
40109	03 06 16	R W W	CH1 scale Decimal point position	Decimal point position of the scale 0 to 3 (Both scale upper and lower limits use the same decimal point position.) Error code: 01H, 02H, 03H, 11H, 12H
40110	03 06 16	R W W	CH1 burnout	0: None, 1: Up burnout, 2: Down burnout Error code: 01H, 02H, 03H, 11H, 12H
40111	03 06 16	R W W	CH1 sensor correction (Offset)	-30000 to 30000 (Decimal point position of scale is used.) Error code: 01H, 02H, 03H, 11H, 12H
40112	03 06 16	R W W	CH1 recording color * multi-point type only	1: Red, 2: Black, 3: Blue, 4: Green, 5: Brown, 6: Purple Error code: 01H, 02H, 03H, 11H, 12H
40113	03 06 16	R W W	CH1 subtract printing Reference CH	ASCII 2 digits (1 <sup>st</sup> digit can use space code) 01 to the number of channels, 00H: No setting
40114	03 06 16	R W W	CH1 subtract printing Subtraction CH	ASCII 2 digits (1 <sup>st</sup> digit can use space code) 01 to the number of channels, 00H: No setting
40115	03 06 16	R W W	CH1 subtract printing reference value	-30000 to 30000 (Decimal point position of scale of reference CH is used.) * This is enabled when subtraction CH is not set. Error code: 01H, 02H, 03H, 11H, 12H
40116	03 06 16	R W W	CH1 subtract printing range Lower limit	-30000 to 30000 (Decimal point position of recording range is used.) Error code: 01H, 02H, 03H, 11H, 12H

Reference No.	Applicable function code	R/W	Description	Details
40117	03	R	CH1 subtract printing range Upper limit	-30000 to 30000 (Decimal point position of recording range is used.) Error code: 01H, 02H, 03H, 11H, 12H
	06	W		
	16	W		
40118	03	R	Input filter * pen type only	0: none, 1: 0.5, 2: 1, 3: 2, 4: 3 5: 4, 6: 5 (sec.) Error code: 01H, 02H, 03H, 11H, 12H
	06	W		
	16	W		
40119	03	R	CH1 unit character 1, 2	ASCII 2 digits 00H: No setting Error code: 01H, 02H, 03H, 11H, 12H
	06	W		
	16	W		
40120	03	R	CH1 unit character 3, 4	ASCII 2 digits 00H: No setting Error code: 01H, 02H, 03H, 11H, 12H
	06	W		
	16	W		
40121	03	R	CH1 unit character 5, 6	ASCII 2 digits 00H: No setting Error code: 01H, 02H, 03H, 11H, 12H
	06	W		
	16	W		
40125	03	R	CH1 tag character 1, 2	ASCII 2 digits 00H: No setting Error code: 01H, 02H, 03H, 11H, 12H
	06	W		
	16	W		
40126	03	R	CH1 tag character 3, 4	ASCII 2 digits 00H: No setting Error code: 01H, 02H, 03H, 11H, 12H
	06	W		
	16	W		
40127	03	R	CH1 tag character 5, 6	ASCII 2 digits 00H: No setting Error code: 01H, 02H, 03H, 11H, 12H
	06	W		
	16	W		
40128	03	R	CH1 tag character 7, 8	ASCII 2 digits 00H: No setting Error code: 01H, 02H, 03H, 11H, 12H
	06	W		
	16	W		
40129	03	R	CH1 tag character 9, 10	ASCII 2 digits 00H: No setting Error code: 01H, 02H, 03H, 11H, 12H
	06	W		
	16	W		
40131	03	R	Integration reset	1: Reset integration Error code: 01H, 02H, 03H, 11H, 12H
	06	W		
	16	W		
40133	03	R	CH1 level 1 Alarm type	0: None, 1: H, 2: L, 3: U, 4: D, 5: B, 6: S Error code: 01H, 02H, 03H, 11H, 12H
	06	W		
	16	W		
40134	03	R	CH1 level 1 Alarm value	-30000 to 30000 (Decimal point position of scale is used.) Error code: 01H, 02H, 03H, 11H, 12H
	06	W		
	16	W		
40135	03	R	CH1 level 1 Alarm output relay No.	ASCII 2 digits (1st digit can use space code) 01 to the number of alarm outputs 00H: No setting, 99: Dummy output Error code: 01H, 02H, 03H, 11H, 12H
	06	W		
	16	W		
40136	03	R	CH1 level 1 Alarm output mode	0: OR, 1: AND Error code: 01H, 02H, 03H, 11H, 12H
	06	W		
	16	W		
40137	03	R	CH1 level 1 Alarm reference CH	ASCII 2 digits (1st digit can use space code) 01 to the number of channels, 00H: No setting * This is enabled when differential alarm is used. Error code: 01H, 02H, 03H, 11H, 12H
	06	W		
	16	W		
40138	03	R	CH1 level 1 Alarm reference time	1 to 6000 * This is enabled when rate-of-change alarm is used. Error code: 01H, 02H, 03H, 11H, 12H
	06	W		
	16	W		

Reference No.	Applicable function code	R/W	Description	Details
40139	03 06 16	R W W	CH1 level 1 Alarm deadband	0 to 30000 (Decimal point position of scale is used.) Error code: 01H, 02H, 03H, 11H, 12H
40140	03 06 16	R W W	CH1 level 1 Alarm delay	0 to 6000 [sec] Error code: 01H, 02H, 03H, 11H, 12H
40141	03 06 16	R W W	CH1 level 2 Alarm type	0: None, 1: H, 2: L, 3: U, 4: D, 5: B, 6: S Error code: 01H, 02H, 03H, 11H, 12H
40142	03 06 16	R W W	CH1 level 2 Alarm value	-30000 to 30000(Decimal point position of scale is used.) Error code: 01H, 02H, 03H, 11H, 12H
40143	03 06 16	R W W	CH1 level 2 Alarm output relay No.	ASCII 2 digits (1st digit can use space code) 01 to the number of alarm outputs 00H: No setting, 99: Dummy output Error code: 01H, 02H, 03H, 11H, 12H
40144	03 06 16	R W W	CH1 level 2 Alarm output mode	0: OR, 1: AND Error code: 01H, 02H, 03H, 11H, 12H
40145	03 06 16	R W W	CH1 level 2 Alarm reference CH	ASCII 2 digits (1st digit can use space code) 01 to the number of channels, 00H: No setting * This is enabled when differential alarm is used. Error code: 01H, 02H, 03H, 11H, 12H
40146	03 06 16	R W W	CH1 level 2 Alarm reference time	1 to 6000 * This is enabled when rate-of-change alarm is used. Error code: 01H, 02H, 03H, 11H, 12H
40147	03 06 16	R W W	CH1 level 2 Alarm deadband	0 to 30000 (Decimal point position of scale is used.) Error code: 01H, 02H, 03H, 11H, 12H
40148	03 06 16	R W W	CH1 level 2 Alarm delay	0 to 6000 [sec] Error code: 01H, 02H, 03H, 11H, 12H
40149	03 06 16	R W W	CH1 level 3 Alarm type	0: None, 1: H, 2: L, 3: U, 4: D, 5: B, 6: S Error code: 01H, 02H, 03H, 11H, 12H
40150	03 06 16	R W W	CH1 level 3 Alarm value	-30000 to 30000 (Decimal point position of scale is used.) Error code: 01H, 02H, 03H, 11H, 12H
40151	03 06 16	R W W	CH1 level 3 Alarm output relay No.	ASCII 2 digits (1st digit can use space code) 01 to the number of alarm outputs 00H: No setting, 99: Dummy output Error code: 01H, 02H, 03H, 11H, 12H
40152	03 06 16	R W W	CH1 level 3 Alarm output mode	0: OR, 1: AND Error code: 01H, 02H, 03H, 11H, 12H
40153	03 06 16	R W W	CH1 level 3 Alarm reference CH	ASCII 2 digits (1st digit can use space code) 01 to the number of channels, 00H: No setting * This is enabled when differential alarm is used. Error code: 01H, 02H, 03H, 11H, 12H
40154	03 06 16	R W W	CH1 level 3 Alarm reference time	1 to 6000 * This is enabled when rate-of-change alarm is used. Error code: 01H, 02H, 03H, 11H, 12H



Reference No.	Applicable function code	R/W	Description	Details
40155	03 06 16	R W W	CH1 level 3 Alarm deadband	0 to 30000 (Decimal point position of scale is used.) Error code: 01H, 02H, 03H, 11H, 12H
40156	03 06 16	R W W	CH1 level 3 Alarm delay	0 to 6000 [sec] Error code: 01H, 02H, 03H, 11H, 12H
40157	03 06 16	R W W	CH1 level 4 Alarm type	0: None, 1: H, 2: L, 3: U, 4: D, 5: B, 6: S Error code: 01H, 02H, 03H, 11H, 12H
40158	03 06 16	R W W	CH1 level 4 Alarm value	-30000 to 30000 (Decimal point position of scale is used.) Error code: 01H, 02H, 03H, 11H, 12H
40159	03 06 16	R W W	CH1 level 4 Alarm output relay No.	ASCII 2 digits (1st digit can use space code) 01 to the number of alarm outputs 00H: No setting, 99: Dummy output Error code: 01H, 02H, 03H, 11H, 12H
40160	03 06 16	R W W	CH1 level 4 Alarm output mode	0: OR, 1: AND Error code: 01H, 02H, 03H, 11H, 12H
40161	03 06 16	R W W	CH1 level 4 Alarm reference CH	ASCII 2 digits (1st digit can use space code) 01 to the number of channels, 00H: No setting * This is enabled when differential alarm is used. Error code: 01H, 02H, 03H, 11H, 12H
40162	03 06 16	R W W	CH1 level 4 Alarm reference time	1 to 6000 * This is enabled when rate-of-change alarm is used. Error code: 01H, 02H, 03H, 11H, 12H
40163	03 06 16	R W W	CH1 level 4 Alarm deadband	0 to 30000 (Decimal point position of scale is used.) Error code: 01H, 02H, 03H, 11H, 12H
40164	03 06 16	R W W	CH1 level 4 Alarm delay	0 to 6000 [sec] Error code: 01H, 02H, 03H, 11H, 12H
40165	03 06 16	R W W	CH1 calculation No.	0: None, 1: Square root, 2: Natural logarithm, 3: Common logarithm, 4: Integration, 5: Temperature and humidity, 6: Data communication input, 7: Arithmetic 1, 8: Arithmetic 2, 9: Max value, 10: Min value, 11: Average value, 12: Exponent, 13: Absolute value 70: Formula, 71: Broken line approximation 72: Low order communication data Error code: 01H, 02H, 03H, 11H, 12H
40166	03 06 16	R W W	CH1 recording range Lower limit	-30000 to 30000 Error code: 01H, 02H, 03H, 11H, 12H
40167	03 06 16	R W W	CH1 recording range Upper limit	-30000 to 30000 Error code: 01H, 02H, 03H, 11H, 12H
40168	03 06 16	R W W	CH1 recording range Decimal point position	0 to 3 (Both recording range upper and lower limits use the same decimal point position.) Error code: 01H, 02H, 03H, 11H, 12H

Reference No.	Applicable function code	R/W	Description	Details
40169	03 06 16	R W W	CH1 calculation constant A	Arithmetic 1 and 2:-30000 to 30000 Integration, max/min/average value, and formula: Interval (hour) ASCII 2 digits (00 to 24, 99: Remote contact (integration only)) Set 00H for other calculations. Error code: 01H, 02H, 03H, 11H, 12H
40170	03 06 16	R W W	CH1 calculation constant A Decimal point	Arithmetic 1 and 2:0 to 3 Integration and formula: Resetting method 0: None, 1: Interval, 2: Remote contact (all), 3: Remote contact (individual) Set 00H for other calculations. Error code: 01H, 02H, 03H, 11H, 12H
40171	03 06 16	R W W	CH1 calculation constant B	Arithmetic 1 and 2:-30000 to 30000 Integration, max/min/average value, and formula: Interval (minute) ASCII 2 digits (00 to 59) Set 00H for other calculations. Error code: 01H, 02H, 03H, 11H, 12H
40172	03 06 16	R W W	CH1 calculation constant B Decimal point	Arithmetic 1 and 2:0 to 3 Integration and formula: Unit of integration time 0: Hour, 1: Minute, 2: Second Set 00H for other calculations. Error code: 01H, 02H, 03H, 11H, 12H
40173	03 06 16	R W W	CH1 calculation constant C	Arithmetic 1:-30000 to 30000 Integration, max/min/average value, and formula: Start time (hour) ASCII 2 digits (00 to 23, 99: Remote contact (integration only)) Set 00H for other calculations. Error code: 01H, 02H, 03H, 11H, 12H
40174	03 06 16	R W W	CH1 calculation constant C Decimal point	Arithmetic 1:0 to 3 Set 00H for other calculations. Error code: 01H, 02H, 03H, 11H, 12H
40175	03 06 16	R W W	CH1 calculation constant D	Arithmetic 1:-30000 to 30000 Integration, max/min/average value, and formula: Start time (minute) ASCII 2 digits (00 to 59) Set 00H for other calculations. Error code: 01H, 02H, 03H, 11H, 12H
40176	03 06 16	R W W	CH1 calculation constant D Decimal point	Arithmetic 1:0 to 3 Set 00H for other calculations. Error code: 01H, 02H, 03H, 11H, 12H
40177	03 06 16	R W W	CH1 calculation Target XCH	ASCII 2 digits (1st digit can use space code) 01 to the number of channels, 00H: No setting Error code: 01H, 02H, 03H, 11H, 12H
40178	03 06 16	R W W	CH1 calculation Target YCH	ASCII 2 digits (1st digit can use space code) 01 to the number of channels Integration, max/min/average value, and formula: Remote contact No. linked to reset Broken line approximation: Table No. used 00H: No setting Error code: 01H, 02H, 03H, 11H, 12H

Reference No.	Applicable function code	R/W	Description	Details
40179	03 06 16	R W W	CH1 calculation result Decimal point	0 to 3 Error code: 01H, 02H, 03H, 11H, 12H
40181	03 06 16	R W W	CH1 compressed/ expanded printing 0% value	-30000 to 30000 (Decimal point position of recording range is used.) Error code: 01H, 02H, 03H, 11H, 12H
40182	03 06 16	R W W	CH1 compressed/ expanded printing 1st break point %	0 to 99 0: Unused Error code: 01H, 02H, 03H, 11H, 12H
40183	03 06 16	R W W	CH1 compressed/ expanded printing 1st break point value	-30000 to 30000 (Decimal point position of recording range is used.) Error code: 01H, 02H, 03H, 11H, 12H
40184	03 06 16	R W W	CH1 compressed/ expanded printing 2nd break point %	0 to 99 0: Unused Error code: 01H, 02H, 03H, 11H, 12H
40185	03 06 16	R W W	CH1 compressed/ expanded printing 2nd break point value	-30000 to 30000 (Decimal point position of recording range is used.) Error code: 01H, 02H, 03H, 11H, 12H
40186	03 06 16	R W W	CH1 compressed/ expanded printing 100% value	-30000 to 30000 (Decimal point position of recording range is used.) Error code: 01H, 02H, 03H, 11H, 12H
40189	03 06 16	R W W	CH1 automatic range-shift 1st range lower limit	-30000 to 30000 (Decimal point position of recording range is used.) -32768: No setting Error code: 01H, 02H, 03H, 11H, 12H
40190	03 06 16	R W W	CH1 automatic range-shift 1st range upper limit	-30000 to 30000 (Decimal point position of recording range is used.) -32768: No setting Error code: 01H, 02H, 03H, 11H, 12H
40191	03 06 16	R W W	CH1 automatic range-shift 2nd range upper limit	-30000 to 30000 (Decimal point position of recording range is used.) -32768: No setting Error code: 01H, 02H, 03H, 11H, 12H
40192	03 06 16	R W W	CH1 automatic range-shift 3rd range upper limit	-30000 to 30000 (Decimal point position of recording range is used.) -32768: No setting Error code: 01H, 02H, 03H, 11H, 12H
40193	03 06 16	R W W	CH1 automatic range-shift 4th range upper limit	-30000 to 30000 (Decimal point position of recording range is used.) -32768: No setting Error code: 01H, 02H, 03H, 11H, 12H
40194	03 06 16	R W W	CH1 automatic range-shift 5th range upper limit	-30000 to 30000 (Decimal point position of recording range is used.) -32768: No setting Error code: 01H, 02H, 03H, 11H, 12H

Reference No.	Applicable function code	R/W	Description	Details
40198	03 06 16	R W W	CH1 Each ON/OFF information	ON/OFF of measured value display, trace printing, digital recording and SD card recording is set by each bit. ON/OFF of each operation is set by the following bit after performing OR operation. 0001H: Measured value display ON/OFF 0002H: Trace printing ON/OFF 0004H: Digital recording ON/OFF 0008H: SD card recording ON/OFF Error code: 01H, 02H, 03H, 11H, 12H
40202 to 40298	03 06 16	R W W	CH2 setting parameter	Same as CH1 parameters (40102 to 40198) Reference No.: CH1 reference No. + 100
40302 to 40398	03 06 16	R W W	CH3 setting parameter	Same as CH1 parameters (40102 to 40198) Reference No.: CH1 reference No. + 200
40402 to 40498	03 06 16	R W W	CH4 setting parameter	Same as CH1 parameters (40102 to 40198) Reference No.: CH1 reference No. + 300
40502 to 40598	03 06 16	R W W	CH5 setting parameter	Same as CH1 parameters (40102 to 40198) Reference No.: CH1 reference No. + 400
40602 to 40698	03 06 16	R W W	CH6 setting parameter	Same as CH1 parameters (40102 to 40198) Reference No.: CH1 reference No. + 500
40702 to 40798	03 06 16	R W W	CH7 setting parameter	Same as CH1 parameters (40102 to 40198) Reference No.: CH1 reference No. + 600
40802 to 42898	03 06 16	R W W	CH8 setting parameter	Same as CH1 parameters (40102 to 40198) Reference No.: CH1 reference No. + 700
40902 to 40998	03 06 16	R W W	CH9 setting parameter	Same as CH1 parameters (40102 to 40198) Reference No.: CH1 reference No. + 800
41002 to 41098	03 06 16	R W W	CH10 setting parameter	Same as CH1 parameters (40102 to 40198) Reference No.: CH1 reference No. + 900
41102 to 41198	03 06 16	R W W	CH11 setting parameter	Same as CH1 parameters (40102 to 40198) Reference No.: CH1 reference No. + 1000
41202 to 41298	03 06 16	R W W	CH12 setting parameter	Same as CH1 parameters (40102 to 40198) Reference No.: CH1 reference No. + 1100
41302 to 41398	03 06 16	R W W	CH13 setting parameter	Same as CH1 parameters (40102 to 40198) Reference No.: CH1 reference No. + 1200
41402 to 41498	03 06 16	R W W	CH14 setting parameter	Same as CH1 parameters (40102 to 40198) Reference No.: CH1 reference No. + 1300
41502 to 41598	03 06 16	R W W	CH15 setting parameter	Same as CH1 parameters (40102 to 40198) Reference No.: CH1 reference No. + 1400

Reference No.	Applicable function code	R/W	Description	Details
41602 to 41698	03 06 16	R W W	CH16 setting parameter	Same as CH1 parameters (40102 to 40198) Reference No.: CH1 reference No. + 1500
41702 to 41798	03 06 16	R W W	CH17 setting parameter	Same as CH1 parameters (40102 to 40198) Reference No.: CH1 reference No. + 1600
41802 to 41898	03 06 16	R W W	CH18 setting parameter	Same as CH1 parameters (40102 to 40198) Reference No.: CH1 reference No. + 1700
41902 to 41998	03 06 16	R W W	CH19 setting parameter	Same as CH1 parameters (40102 to 40198) Reference No.: CH1 reference No. + 1800
42002 to 42098	03 06 16	R W W	CH20 setting parameter	Same as CH1 parameters (40102 to 40198) Reference No.: CH1 reference No. + 1900
42102 to 42198	03 06 16	R W W	CH21 setting parameter	Same as CH1 parameters (40102 to 40198) Reference No.: CH1 reference No. + 2000
42202 to 42298	03 06 16	R W W	CH22 setting parameter	Same as CH1 parameters (40102 to 40198) Reference No.: CH1 reference No. + 2100
42302 to 42398	03 06 16	R W W	CH23 setting parameter	Same as CH1 parameters (40102 to 40198) Reference No.: CH1 reference No. + 2200
42402 to 42498	03 06 16	R W W	CH24 setting parameter	Same as CH1 parameters (40102 to 40198) Reference No.: CH1 reference No. + 2300
44011	03 06 16	R W W	CH1 level 1 Alarm message No.	0 to 20 0: No message printing Error code: 01H, 02H, 03H, 09H, 11H, 12H
44012	03 06 16	R W W	CH1 level 1 Hold alarm display	0: Not hold, 1: Reset by key, 2: Reset by remote contact Error code: 01H, 02H, 03H, 09H, 11H, 12H
44013	03 06 16	R W W	CH1 level 1 Hold alarm output	0: Not hold, 1: Reset by key, 2: Reset by remote contact Error code: 01H, 02H, 03H, 09H, 11H, 12H
44014	03 06 16	R W W	CH1 level 1 Remote contact No. linked to alarm reset	1 to 20 Error code: 01H, 02H, 03H, 09H, 11H, 12H
44015	03 06 16	R W W	CH1 level 2 Alarm message No.	0 to 20 0: No message printing Error code: 01H, 02H, 03H, 09H, 11H, 12H
44016	03 06 16	R W W	CH1 level 2 Hold alarm display	0: Not hold, 1: Reset by key, 2: Reset by remote contact Error code: 01H, 02H, 03H, 09H, 11H, 12H
44017	03 06 16	R W W	CH1 level 2 Hold alarm output	0: Not hold, 1: Reset by key, 2: Reset by remote contact Error code: 01H, 02H, 03H, 09H, 11H, 12H
44018	03 06 16	R W W	CH1 level 2 Remote contact No. linked to alarm reset	1 to 20 Error code: 01H, 02H, 03H, 09H, 11H, 12H
44019	03 06 16	R W W	CH1 level 3 Alarm message No.	0 to 20 0: No message printing Error code: 01H, 02H, 03H, 09H, 11H, 12H

Reference No.	Applicable function code	R/W	Description	Details
44020	03 06 16	R W W	CH1 level 3 Hold alarm display	0: Not hold, 1: Reset by key, 2: Reset by remote contact Error code: 01H, 02H, 03H, 09H, 11H, 12H
44021	03 06 16	R W W	CH1 level 3 Hold alarm output	0: Not hold, 1: Reset by key, 2: Reset by remote contact Error code: 01H, 02H, 03H, 09H, 11H, 12H
44022	03 06 16	R W W	CH1 level 3 Remote contact No. linked to alarm reset	1 to 20 Error code: 01H, 02H, 03H, 09H, 11H, 12H
44023	03 06 16	R W W	CH1 level 4 Alarm message No.	0 to 20 0: No message printing Error code: 01H, 02H, 03H, 09H, 11H, 12H
44024	03 06 16	R W W	CH1 level 4 Hold alarm display	0: Not hold, 1: Reset by key, 2: Reset by remote contact Error code: 01H, 02H, 03H, 09H, 11H, 12H
44025	03 06 16	R W W	CH1 level 4 Hold alarm output	0: Not hold, 1: Reset by key, 2: Reset by remote contact Error code: 01H, 02H, 03H, 09H, 11H, 12H
44026	03 06 16	R W W	CH1 level 4 Remote contact No. linked to alarm reset	1 to 20 Error code: 01H, 02H, 03H, 09H, 11H, 12H
44027 to 44042	03 06 16	R W W	CH2 alarm expansion parameter	Same as CH1 alarm expansion parameters (44011 to 44026)
44043 to 44058	03 06 16	R W W	CH3 alarm expansion parameter	Same as CH1 alarm expansion parameters (44011 to 44026)
44059 to 44074	03 06 16	R W W	CH4 alarm expansion parameter	Same as CH1 alarm expansion parameters (44011 to 44026)
44075 to 44090	03 06 16	R W W	CH5 alarm expansion parameter	Same as CH1 alarm expansion parameters (44011 to 44026)
44091 to 44106	03 06 16	R W W	CH6 alarm expansion parameter	Same as CH1 alarm expansion parameters (44011 to 44026)
44107 to 44122	03 06 16	R W W	CH7 alarm expansion parameter	Same as CH1 alarm expansion parameters (44011 to 44026)
44123 to 44138	03 06 16	R W W	CH8 alarm expansion parameter	Same as CH1 alarm expansion parameters (44011 to 44026)
44139 to 44154	03 06 16	R W W	CH9 alarm expansion parameter	Same as CH1 alarm expansion parameters (44011 to 44026)
44155 to 44170	03 06 16	R W W	CH10 alarm expansion parameter	Same as CH1 alarm expansion parameters (44011 to 44026)
44171 to 44186	03 06 16	R W W	CH11 alarm expansion parameter	Same as CH1 alarm expansion parameters (44011 to 44026)
44187 to 44202	03 06 16	R W W	CH12 alarm expansion parameter	Same as CH1 alarm expansion parameters (44011 to 44026)

Reference No.	Applicable function code	R/W	Description	Details
44203 to 44218	03 06 16	R W W	CH13 alarm expansion parameter	Same as CH1 alarm expansion parameters (44011 to 44026)
44219 to 44234	03 06 16	R W W	CH14 alarm expansion parameter	Same as CH1 alarm expansion parameters (44011 to 44026)
44235 to 44250	03 06 16	R W W	CH15 alarm expansion parameter	Same as CH1 alarm expansion parameters (44011 to 44026)
44251 to 44266	03 06 16	R W W	CH16 alarm expansion parameter	Same as CH1 alarm expansion parameters (44011 to 44026)
44267 to 44282	03 06 16	R W W	CH17 alarm expansion parameter	Same as CH1 alarm expansion parameters (44011 to 44026)
44283 to 44298	03 06 16	R W W	CH18 alarm expansion parameter	Same as CH1 alarm expansion parameters (44011 to 44026)
44299 to 44314	03 06 16	R W W	CH19 alarm expansion parameter	Same as CH1 alarm expansion parameters (44011 to 44026)
44315 to 44330	03 06 16	R W W	CH20 alarm expansion parameter	Same as CH1 alarm expansion parameters (44011 to 44026)
44331 to 44346	03 06 16	R W W	CH21 alarm expansion parameter	Same as CH1 alarm expansion parameters (44011 to 44026)
44347 to 44362	03 06 16	R W W	CH22 alarm expansion parameter	Same as CH1 alarm expansion parameters (44011 to 44026)
44363 to 44378	03 06 16	R W W	CH23 alarm expansion parameter	Same as CH1 alarm expansion parameters (44011 to 44026)
44379 to 44394	03 06 16	R W W	CH24 alarm expansion parameter	Same as CH1 alarm expansion parameters (44011 to 44026)

## 3) Communication (Ethernet)

R/W ... R: READ, W: WRITE

Reference No.	Applicable function code	R/W	Description	Details
45001	03 06 16	R W W	IP address 1, 2	IP address Error code: 01H, 02H, 03H, 09H, 11H, 12H
45002	03 06 16	R W W	IP address 3, 4	IP address Error code: 01H, 02H, 03H, 09H, 11H, 12H
45003	03 06 16	R W W	Subnet mask 1, 2	Subnet mask Error code: 01H, 02H, 03H, 09H, 11H, 12H
45004	03 06 16	R W W	Subnet mask 3, 4	Subnet mask Error code: 01H, 02H, 03H, 09H, 11H, 12H
45005	03 06 16	R W W	Default gateway 1, 2	Default gateway Error code: 01H, 02H, 03H, 09H, 11H, 12H
45006	03 06 16	R W W	Default gateway 3, 4	Default gateway Error code: 01H, 02H, 03H, 09H, 11H, 12H
45007	03 06 16	R W W	Socket communication port No.	0 to 65535 Error code: 01H, 02H, 03H, 09H, 11H, 12H
45111	03 06 16	R W W	Login password (server) 1, 2	ASCII 2 digits * Characters after 00H are invalid. Error code: 01H, 02H, 03H, 09H, 11H, 12H
45112	03 06 16	R W W	Login password (server) 3, 4	ASCII 2 digits * Characters after 00H are invalid. Error code: 01H, 02H, 03H, 09H, 11H, 12H
45113	03 06 16	R W W	Login password (server) 5, 6	ASCII 2 digits * Characters after 00H are invalid. Error code: 01H, 02H, 03H, 09H, 11H, 12H
45114	03 06 16	R W W	Login password (server) 7, 8	ASCII 2 digits * Characters after 00H are invalid. Error code: 01H, 02H, 03H, 09H, 11H, 12H
45115	03 06 16	R W W	Login password (server) 9, 10	ASCII 2 digits * Characters after 00H are invalid. Error code: 01H, 02H, 03H, 09H, 11H, 12H
45116	03 06 16	R W W	Login password (server) 11, 12	ASCII 2 digits * Characters after 00H are invalid. Error code: 01H, 02H, 03H, 09H, 11H, 12H
45117	03 06 16	R W W	Login password (server) 13, 14	ASCII 2 digits * Characters after 00H are invalid. Error code: 01H, 02H, 03H, 09H, 11H, 12H
45118	03 06 16	R W W	Login password (server) 15, 16	ASCII 2 digits * Characters after 00H are invalid. Error code: 01H, 02H, 03H, 09H, 11H, 12H
45119	03 06 16	R W W	Login password (server) 17, 18	ASCII 2 digits * Characters after 00H are invalid. Error code: 01H, 02H, 03H, 09H, 11H, 12H
45120	03 06 16	R W W	Login password (server) 19, 20	ASCII 2 digits * Characters after 00H are invalid. Error code: 01H, 02H, 03H, 09H, 11H, 12H



Reference No.	Applicable function code	R/W	Description	Details
45121	03 06 16	R W W	Login password (server) 21, 22	ASCII 2 digits * Characters after 00H are invalid. Error code: 01H, 02H, 03H, 09H, 11H, 12H
45122	03 06 16	R W W	Login password (server) 23, 24	ASCII 2 digits * Characters after 00H are invalid. Error code: 01H, 02H, 03H, 09H, 11H, 12H
45123	03 06 16	R W W	Login password (server) 25, 26	ASCII 2 digits * Characters after 00H are invalid. Error code: 01H, 02H, 03H, 09H, 11H, 12H
45124	03 06 16	R W W	Login password (server) 27, 28	ASCII 2 digits * Characters after 00H are invalid. Error code: 01H, 02H, 03H, 09H, 11H, 12H
45125	03 06 16	R W W	Login password (server) 29, 30	ASCII 2 digits * Characters after 00H are invalid. Error code: 01H, 02H, 03H, 09H, 11H, 12H
45126	03 06 16	R W W	Login password (server) 31, 32	ASCII 2 digits * Characters after 00H are invalid. Error code: 01H, 02H, 03H, 09H, 11H, 12H
45141	03 06 16	R W W	E-mail transmission condition 1 Select condition/ transmission address No.	Select condition (high-order 1 byte) 0: Unused, 1: Alarm activation, 2: Fixed interval, 3: Fail out Transmission address No. (low-order 1 byte): Bit supported Bit 0 to 2 → address 1 to 3
45142	03 06 16	R W W	E-mail transmission condition 1 Transmission CH First/end No.	First channel No. (high-order 1 byte): 1 to 24 End channel No. (low-order 1 byte): 1 to 24 Error code: 01H, 02H, 03H, 09H, 11H, 12H
45143	03 06 16	R W W	E-mail transmission condition 1 Reference hour/minute	Reference hour (high-order 1 byte): 0 to 23 Reference minute (low-order 1 byte): 0 to 59 Error code: 01H, 02H, 03H, 09H, 11H, 12H
45144	03 06 16	R W W	E-mail transmission condition 1 Interval hour/minute	Interval hour (high-order 1 byte): 0 to 24 Interval minute (low-order 1 byte): 0 to 59 Error code: 01H, 02H, 03H, 09H, 11H, 12H
45145 to 45148	03 06 16	R W W	E-mail transmission condition 2	Same as E-mail transmission condition 1 (45141 to 45144)
45149 to 45152	03 06 16	R W W	E-mail transmission condition 3	Same as E-mail transmission condition 1 (45141 to 45144)
45153 to 45156	03 06 16	R W W	E-mail transmission condition 4	Same as E-mail transmission condition 1 (45141 to 45144)
45157 to 45160	03 06 16	R W W	E-mail transmission condition 5	Same as E-mail transmission condition 1 (45141 to 45144)
45161 to 45164	03 06 16	R W W	E-mail transmission condition 6	Same as E-mail transmission condition 1 (45141 to 45144)
45181	03 06 16	R W W	E-mail transmission address 1 1, 2	ASCII 2 digits * Characters after 00H are invalid. Error code: 01H, 02H, 03H, 09H, 11H, 12H

Reference No.	Applicable function code	R/W	Description	Details
45182	03 06 16	R W W	E-mail transmission address 1 3, 4	ASCII 2 digits * Characters after 00H are invalid. Error code: 01H, 02H, 03H, 09H, 11H, 12H
45183	03 06 16	R W W	E-mail transmission address 1 5, 6	ASCII 2 digits * Characters after 00H are invalid. Error code: 01H, 02H, 03H, 09H, 11H, 12H
45184	03 06 16	R W W	E-mail transmission address 1 7, 8	ASCII 2 digits * Characters after 00H are invalid. Error code: 01H, 02H, 03H, 09H, 11H, 12H
45185	03 06 16	R W W	E-mail transmission address 1 9, 10	ASCII 2 digits * Characters after 00H are invalid. Error code: 01H, 02H, 03H, 09H, 11H, 12H
45186	03 06 16	R W W	E-mail transmission address 1 11, 12	ASCII 2 digits * Characters after 00H are invalid. Error code: 01H, 02H, 03H, 09H, 11H, 12H
45187	03 06 16	R W W	E-mail transmission address 1 13, 14	ASCII 2 digits * Characters after 00H are invalid. Error code: 01H, 02H, 03H, 09H, 11H, 12H
45188	03 06 16	R W W	E-mail transmission address 1 15, 16	ASCII 2 digits * Characters after 00H are invalid. Error code: 01H, 02H, 03H, 09H, 11H, 12H
45189	03 06 16	R W W	E-mail transmission address 1 17, 18	ASCII 2 digits * Characters after 00H are invalid. Error code: 01H, 02H, 03H, 09H, 11H, 12H
45190	03 06 16	R W W	E-mail transmission address 1 19, 20	ASCII 2 digits * Characters after 00H are invalid. Error code: 01H, 02H, 03H, 09H, 11H, 12H
45191	03 06 16	R W W	E-mail transmission address 1 21, 22	ASCII 2 digits * Characters after 00H are invalid. Error code: 01H, 02H, 03H, 09H, 11H, 12H
45192	03 06 16	R W W	E-mail transmission address 1 23, 24	ASCII 2 digits * Characters after 00H are invalid. Error code: 01H, 02H, 03H, 09H, 11H, 12H
45193	03 06 16	R W W	E-mail transmission address 1 25, 26	ASCII 2 digits * Characters after 00H are invalid. Error code: 01H, 02H, 03H, 09H, 11H, 12H
45194	03 06 16	R W W	E-mail transmission address 1 27, 28	ASCII 2 digits * Characters after 00H are invalid. Error code: 01H, 02H, 03H, 09H, 11H, 12H
45195	03 06 16	R W W	E-mail transmission address 1 29, 30	ASCII 2 digits * Characters after 00H are invalid. Error code: 01H, 02H, 03H, 09H, 11H, 12H
45196	03 06 16	R W W	E-mail transmission address 1 31, 32	ASCII 2 digits * Characters after 00H are invalid. Error code: 01H, 02H, 03H, 09H, 11H, 12H
45197 to 45212	03 06 16	R W W	E-mail transmission address 2	Same as E-mail address 1 (45181 to 45196)
45213 to 45228	03 06 16	R W W	E-mail transmission address 3	Same as E-mail address 1 (45181 to 45196)
45361	03 06 16	R W W	POP3 address 1, 2	ASCII 2 digits * Characters after 00H are invalid. Error code: 01H, 02H, 03H, 09H, 11H, 12H

Reference No.	Applicable function code	R/W	Description	Details
45362	03	R	POP3 address 3, 4	ASCII 2 digits
	06	W		* Characters after 00H are invalid.
	16	W		Error code: 01H, 02H, 03H, 09H, 11H, 12H
45363	03	R	POP3 address 5, 6	ASCII 2 digits
	06	W		* Characters after 00H are invalid.
	16	W		Error code: 01H, 02H, 03H, 09H, 11H, 12H
45364	03	R	POP3 address 7, 8	ASCII 2 digits
	06	W		* Characters after 00H are invalid.
	16	W		Error code: 01H, 02H, 03H, 09H, 11H, 12H
45365	03	R	POP3 address 9, 10	ASCII 2 digits
	06	W		* Characters after 00H are invalid.
	16	W		Error code: 01H, 02H, 03H, 09H, 11H, 12H
45366	03	R	POP3 address 11, 12	ASCII 2 digits
	06	W		* Characters after 00H are invalid.
	16	W		Error code: 01H, 02H, 03H, 09H, 11H, 12H
45367	03	R	POP3 address 13, 14	ASCII 2 digits
	06	W		* Characters after 00H are invalid.
	16	W		Error code: 01H, 02H, 03H, 09H, 11H, 12H
45368	03	R	POP3 address 15, 16	ASCII 2 digits
	06	W		* Characters after 00H are invalid.
	16	W		Error code: 01H, 02H, 03H, 09H, 11H, 12H
45369	03	R	POP3 address 17, 18	ASCII 2 digits
	06	W		* Characters after 00H are invalid.
	16	W		Error code: 01H, 02H, 03H, 09H, 11H, 12H
45370	03	R	POP3 address 19, 20	ASCII 2 digits
	06	W		* Characters after 00H are invalid.
	16	W		Error code: 01H, 02H, 03H, 09H, 11H, 12H
45371	03	R	POP3 address 21, 22	ASCII 2 digits
	06	W		* Characters after 00H are invalid.
	16	W		Error code: 01H, 02H, 03H, 09H, 11H, 12H
45372	03	R	POP3 address 23, 24	ASCII 2 digits
	06	W		* Characters after 00H are invalid.
	16	W		Error code: 01H, 02H, 03H, 09H, 11H, 12H
45373	03	R	POP3 address 25, 26	ASCII 2 digits
	06	W		* Characters after 00H are invalid.
	16	W		Error code: 01H, 02H, 03H, 09H, 11H, 12H
45374	03	R	POP3 address 27, 28	ASCII 2 digits
	06	W		* Characters after 00H are invalid.
	16	W		Error code: 01H, 02H, 03H, 09H, 11H, 12H
45375	03	R	POP3 address 29, 30	ASCII 2 digits
	06	W		* Characters after 00H are invalid.
	16	W		Error code: 01H, 02H, 03H, 09H, 11H, 12H
45376	03	R	POP3 address 31, 32	ASCII 2 digits
	06	W		* Characters after 00H are invalid.
	16	W		Error code: 01H, 02H, 03H, 09H, 11H, 12H
45381	03	R	SMTP address 1, 2	ASCII 2 digits
	06	W		* Characters after 00H are invalid.
	16	W		Error code: 01H, 02H, 03H, 09H, 11H, 12H
45382	03	R	SMTP address 3, 4	ASCII 2 digits
	06	W		* Characters after 00H are invalid.
	16	W		Error code: 01H, 02H, 03H, 09H, 11H, 12H
45383	03	R	SMTP address 5, 6	ASCII 2 digits
	06	W		* Characters after 00H are invalid.
	16	W		Error code: 01H, 02H, 03H, 09H, 11H, 12H

Reference No.	Applicable function code	R/W	Description	Details
45384	03	R	SMTP address 7, 8	ASCII 2 digits
	06	W		* Characters after 00H are invalid.
	16	W		Error code: 01H, 02H, 03H, 09H, 11H, 12H
45385	03	R	SMTP address 9, 10	ASCII 2 digits
	06	W		* Characters after 00H are invalid.
	16	W		Error code: 01H, 02H, 03H, 09H, 11H, 12H
45386	03	R	SMTP address 11, 12	ASCII 2 digits
	06	W		* Characters after 00H are invalid.
	16	W		Error code: 01H, 02H, 03H, 09H, 11H, 12H
45387	03	R	SMTP address 13, 14	ASCII 2 digits
	06	W		* Characters after 00H are invalid.
	16	W		Error code: 01H, 02H, 03H, 09H, 11H, 12H
45388	03	R	SMTP address 15, 16	ASCII 2 digits
	06	W		* Characters after 00H are invalid.
	16	W		Error code: 01H, 02H, 03H, 09H, 11H, 12H
45389	03	R	SMTP address 17, 18	ASCII 2 digits
	06	W		* Characters after 00H are invalid.
	16	W		Error code: 01H, 02H, 03H, 09H, 11H, 12H
45390	03	R	SMTP address 19, 20	ASCII 2 digits
	06	W		* Characters after 00H are invalid.
	16	W		Error code: 01H, 02H, 03H, 09H, 11H, 12H
45391	03	R	SMTP address 21, 22	ASCII 2 digits
	06	W		* Characters after 00H are invalid.
	16	W		Error code: 01H, 02H, 03H, 09H, 11H, 12H
45392	03	R	SMTP address 23, 24	ASCII 2 digits
	06	W		* Characters after 00H are invalid.
	16	W		Error code: 01H, 02H, 03H, 09H, 11H, 12H
45393	03	R	SMTP address 25, 26	ASCII 2 digits
	06	W		* Characters after 00H are invalid.
	16	W		Error code: 01H, 02H, 03H, 09H, 11H, 12H
45394	03	R	SMTP address 27, 28	ASCII 2 digits
	06	W		* Characters after 00H are invalid.
	16	W		Error code: 01H, 02H, 03H, 09H, 11H, 12H
45395	03	R	SMTP address 29, 30	ASCII 2 digits
	06	W		* Characters after 00H are invalid.
	16	W		Error code: 01H, 02H, 03H, 09H, 11H, 12H
45396	03	R	SMTP address 31, 32	ASCII 2 digits
	06	W		* Characters after 00H are invalid.
	16	W		Error code: 01H, 02H, 03H, 09H, 11H, 12H
45401	03	R	Sender address 1, 2	ASCII 2 digits
	06	W		* Characters after 00H are invalid.
	16	W		Error code: 01H, 02H, 03H, 09H, 11H, 12H
45402	03	R	Sender address 3, 4	ASCII 2 digits
	06	W		* Characters after 00H are invalid.
	16	W		Error code: 01H, 02H, 03H, 09H, 11H, 12H
45403	03	R	Sender address 5, 6	ASCII 2 digits
	06	W		* Characters after 00H are invalid.
	16	W		Error code: 01H, 02H, 03H, 09H, 11H, 12H
45404	03	R	Sender address 7, 8	ASCII 2 digits
	06	W		* Characters after 00H are invalid.
	16	W		Error code: 01H, 02H, 03H, 09H, 11H, 12H
45405	03	R	Sender address 9, 10	ASCII 2 digits
	06	W		* Characters after 00H are invalid.
	16	W		Error code: 01H, 02H, 03H, 09H, 11H, 12H

Reference No.	Applicable function code	R/W	Description	Details
45406	03	R	Sender address 11, 12	ASCII 2 digits
	06	W		* Characters after 00H are invalid.
	16	W		Error code: 01H, 02H, 03H, 09H, 11H, 12H
45407	03	R	Sender address 13, 14	ASCII 2 digits
	06	W		* Characters after 00H are invalid.
	16	W		Error code: 01H, 02H, 03H, 09H, 11H, 12H
45408	03	R	Sender address 15, 16	ASCII 2 digits
	06	W		* Characters after 00H are invalid.
	16	W		Error code: 01H, 02H, 03H, 09H, 11H, 12H
45409	03	R	Sender address 17, 18	ASCII 2 digits
	06	W		* Characters after 00H are invalid.
	16	W		Error code: 01H, 02H, 03H, 09H, 11H, 12H
45410	03	R	Sender address 19, 20	ASCII 2 digits
	06	W		* Characters after 00H are invalid.
	16	W		Error code: 01H, 02H, 03H, 09H, 11H, 12H
45411	03	R	Sender address 21, 22	ASCII 2 digits
	06	W		* Characters after 00H are invalid.
	16	W		Error code: 01H, 02H, 03H, 09H, 11H, 12H
45412	03	R	Sender address 23, 24	ASCII 2 digits
	06	W		* Characters after 00H are invalid.
	16	W		Error code: 01H, 02H, 03H, 09H, 11H, 12H
45413	03	R	Sender address 25, 26	ASCII 2 digits
	06	W		* Characters after 00H are invalid.
	16	W		Error code: 01H, 02H, 03H, 09H, 11H, 12H
45414	03	R	Sender address 27, 28	ASCII 2 digits
	06	W		* Characters after 00H are invalid.
	16	W		Error code: 01H, 02H, 03H, 09H, 11H, 12H
45415	03	R	Sender address 29, 30	ASCII 2 digits
	06	W		* Characters after 00H are invalid.
	16	W		Error code: 01H, 02H, 03H, 09H, 11H, 12H
45416	03	R	Sender address 31, 32	ASCII 2 digits
	06	W		* Characters after 00H are invalid.
	16	W		Error code: 01H, 02H, 03H, 09H, 11H, 12H
45421	03	R	Mail account 1, 2	ASCII 2 digits
	06	W		* Characters after 00H are invalid.
	16	W		Error code: 01H, 02H, 03H, 09H, 11H, 12H
45422	03	R	Mail account 3, 4	ASCII 2 digits
	06	W		* Characters after 00H are invalid.
	16	W		Error code: 01H, 02H, 03H, 09H, 11H, 12H
45423	03	R	Mail account 5, 6	ASCII 2 digits
	06	W		* Characters after 00H are invalid.
	16	W		Error code: 01H, 02H, 03H, 09H, 11H, 12H
45424	03	R	Mail account 7, 8	ASCII 2 digits
	06	W		* Characters after 00H are invalid.
	16	W		Error code: 01H, 02H, 03H, 09H, 11H, 12H
45425	03	R	Mail account 9, 10	ASCII 2 digits
	06	W		* Characters after 00H are invalid.
	16	W		Error code: 01H, 02H, 03H, 09H, 11H, 12H
45426	03	R	Mail account 11, 12	ASCII 2 digits
	06	W		* Characters after 00H are invalid.
	16	W		Error code: 01H, 02H, 03H, 09H, 11H, 12H
45427	03	R	Mail account 13, 14	ASCII 2 digits
	06	W		* Characters after 00H are invalid.
	16	W		Error code: 01H, 02H, 03H, 09H, 11H, 12H

Reference No.	Applicable function code	R/W	Description	Details
45428	03	R	Mail account 15, 16	ASCII 2 digits
	06	W		* Characters after 00H are invalid.
	16	W		Error code: 01H, 02H, 03H, 09H, 11H, 12H
45429	03	R	Mail account 17, 18	ASCII 2 digits
	06	W		* Characters after 00H are invalid.
	16	W		Error code: 01H, 02H, 03H, 09H, 11H, 12H
45430	03	R	Mail account 19, 20	ASCII 2 digits
	06	W		* Characters after 00H are invalid.
	16	W		Error code: 01H, 02H, 03H, 09H, 11H, 12H
45431	03	R	Mail account 21, 22	ASCII 2 digits
	06	W		* Characters after 00H are invalid.
	16	W		Error code: 01H, 02H, 03H, 09H, 11H, 12H
45432	03	R	Mail account 23, 24	ASCII 2 digits
	06	W		* Characters after 00H are invalid.
	16	W		Error code: 01H, 02H, 03H, 09H, 11H, 12H
45433	03	R	Mail account 25, 26	ASCII 2 digits
	06	W		* Characters after 00H are invalid.
	16	W		Error code: 01H, 02H, 03H, 09H, 11H, 12H
45434	03	R	Mail account 27, 28	ASCII 2 digits
	06	W		* Characters after 00H are invalid.
	16	W		Error code: 01H, 02H, 03H, 09H, 11H, 12H
45435	03	R	Mail account 29, 30	ASCII 2 digits
	06	W		* Characters after 00H are invalid.
	16	W		Error code: 01H, 02H, 03H, 09H, 11H, 12H
45436	03	R	Mail account 31, 32	ASCII 2 digits
	06	W		* Characters after 00H are invalid.
	16	W		Error code: 01H, 02H, 03H, 09H, 11H, 12H
45441	03	R	Mail password 1, 2	ASCII 2 digits
	06	W		* Characters after 00H are invalid.
	16	W		Error code: 01H, 02H, 03H, 09H, 11H, 12H
45442	03	R	Mail password 3, 4	ASCII 2 digits
	06	W		* Characters after 00H are invalid.
	16	W		Error code: 01H, 02H, 03H, 09H, 11H, 12H
45443	03	R	Mail password 5, 6	ASCII 2 digits
	06	W		* Characters after 00H are invalid.
	16	W		Error code: 01H, 02H, 03H, 09H, 11H, 12H
45444	03	R	Mail password 7, 8	ASCII 2 digits
	06	W		* Characters after 00H are invalid.
	16	W		Error code: 01H, 02H, 03H, 09H, 11H, 12H
45445	03	R	Mail password 9, 10	ASCII 2 digits
	06	W		* Characters after 00H are invalid.
	16	W		Error code: 01H, 02H, 03H, 09H, 11H, 12H
45446	03	R	Mail password 11, 12	ASCII 2 digits
	06	W		* Characters after 00H are invalid.
	16	W		Error code: 01H, 02H, 03H, 09H, 11H, 12H
45447	03	R	Mail password 13, 14	ASCII 2 digits
	06	W		* Characters after 00H are invalid.
	16	W		Error code: 01H, 02H, 03H, 09H, 11H, 12H
45448	03	R	Mail password 15, 16	ASCII 2 digits
	06	W		* Characters after 00H are invalid.
	16	W		Error code: 01H, 02H, 03H, 09H, 11H, 12H
45449	03	R	Mail password 17, 18	ASCII 2 digits
	06	W		* Characters after 00H are invalid.
	16	W		Error code: 01H, 02H, 03H, 09H, 11H, 12H

Reference No.	Applicable function code	R/W	Description	Details
45450	03	R	Mail password 19, 20	ASCII 2 digits
	06	W		* Characters after 00H are invalid.
	16	W		Error code: 01H, 02H, 03H, 09H, 11H, 12H
45451	03	R	Mail password 21, 22	ASCII 2 digits
	06	W		* Characters after 00H are invalid.
	16	W		Error code: 01H, 02H, 03H, 09H, 11H, 12H
45452	03	R	Mail password 23, 24	ASCII 2 digits
	06	W		* Characters after 00H are invalid.
	16	W		Error code: 01H, 02H, 03H, 09H, 11H, 12H
45453	03	R	Mail password 25, 26	ASCII 2 digits
	06	W		* Characters after 00H are invalid.
	16	W		Error code: 01H, 02H, 03H, 09H, 11H, 12H
45454	03	R	Mail password 27, 28	ASCII 2 digits
	06	W		* Characters after 00H are invalid.
	16	W		Error code: 01H, 02H, 03H, 09H, 11H, 12H
45455	03	R	Mail password 29, 30	ASCII 2 digits
	06	W		* Characters after 00H are invalid.
	16	W		Error code: 01H, 02H, 03H, 09H, 11H, 12H
45456	03	R	Mail password 31, 32	ASCII 2 digits
	06	W		* Characters after 00H are invalid.
	16	W		Error code: 01H, 02H, 03H, 09H, 11H, 12H
45461	03	R	DNS ON/OFF	0: OFF, 1: ON
	06	W		Error code: 01H, 02H, 03H, 09H, 11H, 12H
	16	W		
45462	03	R	DNS primary server IP address 1, 2	High-order 16 bits
	06	W		Error code: 01H, 02H, 03H, 09H, 11H, 12H
	16	W		
45463	03	R	DNS primary server IP address 3, 4	High-order 16 bits
	06	W		Error code: 01H, 02H, 03H, 09H, 11H, 12H
	16	W		
45464	03	R	DNS secondary server IP address 1, 2	High-order 16 bits
	06	W		Error code: 01H, 02H, 03H, 09H, 11H, 12H
	16	W		
45465	03	R	DNS secondary server IP address 3, 4	High-order 16 bits
	06	W		Error code: 01H, 02H, 03H, 09H, 11H, 12H
	16	W		
45466	03	R	SNTP ON/OFF	0: OFF, 1: ON
	06	W		Error code: 01H, 02H, 03H, 09H, 11H, 12H
	16	W		
45467	03	R	SNTP server 1, 2	ASCII 2 digits
	06	W		* Characters after 00H are invalid.
	16	W		Error code: 01H, 02H, 03H, 09H, 11H, 12H
45468	03	R	SNTP server 3, 4	ASCII 2 digits
	06	W		* Characters after 00H are invalid.
	16	W		Error code: 01H, 02H, 03H, 09H, 11H, 12H
45469	03	R	SNTP server 5, 6	ASCII 2 digits
	06	W		* Characters after 00H are invalid.
	16	W		Error code: 01H, 02H, 03H, 09H, 11H, 12H
45470	03	R	SNTP server 7, 8	ASCII 2 digits
	06	W		* Characters after 00H are invalid.
	16	W		Error code: 01H, 02H, 03H, 09H, 11H, 12H
45471	03	R	SNTP server 9, 10	ASCII 2 digits
	06	W		* Characters after 00H are invalid.
	16	W		Error code: 01H, 02H, 03H, 09H, 11H, 12H

Reference No.	Applicable function code	R/W	Description	Details
45472	03	R	SNTP server 11, 12	ASCII 2 digits
	06	W		* Characters after 00H are invalid.
	16	W		Error code: 01H, 02H, 03H, 09H, 11H, 12H
45473	03	R	SNTP server 13, 14	ASCII 2 digits
	06	W		* Characters after 00H are invalid.
	16	W		Error code: 01H, 02H, 03H, 09H, 11H, 12H
45474	03	R	SNTP server 15, 16	ASCII 2 digits
	06	W		* Characters after 00H are invalid.
	16	W		Error code: 01H, 02H, 03H, 09H, 11H, 12H
45475	03	R	SNTP server 17, 18	ASCII 2 digits
	06	W		* Characters after 00H are invalid.
	16	W		Error code: 01H, 02H, 03H, 09H, 11H, 12H
45476	03	R	SNTP server 19, 20	ASCII 2 digits
	06	W		* Characters after 00H are invalid.
	16	W		Error code: 01H, 02H, 03H, 09H, 11H, 12H
45477	03	R	SNTP server 21, 22	ASCII 2 digits
	06	W		* Characters after 00H are invalid.
	16	W		Error code: 01H, 02H, 03H, 09H, 11H, 12H
45478	03	R	SNTP server 23, 24	ASCII 2 digits
	06	W		* Characters after 00H are invalid.
	16	W		Error code: 01H, 02H, 03H, 09H, 11H, 12H
45479	03	R	SNTP server 25, 26	ASCII 2 digits
	06	W		* Characters after 00H are invalid.
	16	W		Error code: 01H, 02H, 03H, 09H, 11H, 12H
45480	03	R	SNTP server 27, 28	ASCII 2 digits
	06	W		* Characters after 00H are invalid.
	16	W		Error code: 01H, 02H, 03H, 09H, 11H, 12H
45481	03	R	SNTP server 29, 30	ASCII 2 digits
	06	W		* Characters after 00H are invalid.
	16	W		Error code: 01H, 02H, 03H, 09H, 11H, 12H
45482	03	R	SNTP server 31, 32	ASCII 2 digits
	06	W		* Characters after 00H are invalid.
	16	W		Error code: 01H, 02H, 03H, 09H, 11H, 12H
45483	03	R	Inquiry reference time Hour/minute	Reference time hour (high-order 1 byte): 0 to 23
	06	W		Reference time minute (low-order 1 byte): 0 to 59
	16	W		Error code: 01H, 02H, 03H, 09H, 11H, 12H
45485	03	R	SMTP port No.	1 to 65535 Error code: 01H, 02H, 03H, 09H, 11H, 12H
45486	03	R	POP3 port No.	1 to 65535 Error code: 01H, 02H, 03H, 09H, 11H, 12H
45487	03	R	POP3 authentication before SMTP	0: None, 1: POP, 2: APOP
	06	W		Error code: 01H, 02H, 03H, 09H, 11H, 12H
	16	W		



## 4) Calendar timer

R/W ... R: READ, W: WRITE

Reference No.	Applicable function code	R/W	Description	Details
46501	03 06 16	R W W	Calendar timer 1 Mode	0: Unused, 1: Specify ON time only, 2: Specify ON and OFF times Error code: 01H, 02H, 03H, 11H, 12H
46502	03 06 16	R W W	Calendar timer 1 ON time (year)	00 to 99: 2000 to 2099 Error code: 01H, 02H, 03H, 11H, 12H
46503	03 06 16	R W W	Calendar timer 1 ON time (month)	01 to 12 Error code: 01H, 02H, 03H, 11H, 12H
46504	03 06 16	R W W	Calendar timer 1 ON time (day)	01 to 31 Error code: 01H, 02H, 03H, 11H, 12H
46505	03 06 16	R W W	Calendar timer 1 ON time (hour)	00 to 23 Error code: 01H, 02H, 03H, 11H, 12H
46506	03 06 16	R W W	Calendar timer 1 ON time (minute)	00 to 59 Error code: 01H, 02H, 03H, 11H, 12H
46507	03 06 16	R W W	Calendar timer 1 OFF time (year)	00 to 99: 2000 to 2099 Error code: 01H, 02H, 03H, 11H, 12H
46508	03 06 16	R W W	Calendar timer 1 OFF time (month)	01 to 12 Error code: 01H, 02H, 03H, 11H, 12H
46509	03 06 16	R W W	Calendar timer 1 OFF time (day)	01 to 31 Error code: 01H, 02H, 03H, 11H, 12H
46510	03 06 16	R W W	Calendar timer 1 OFF time (hour)	00 to 23 Error code: 01H, 02H, 03H, 11H, 12H
46511	03 06 16	R W W	Calendar timer 1 OFF time (minute)	00 to 59 Error code: 01H, 02H, 03H, 11H, 12H
46512	03 06 16	R W W	Calendar timer 1 Message printing No.	0 to 20 0: No message printing Error code: 01H, 02H, 03H, 11H, 12H
46513	03 06 16	R W W	Calendar timer 1 Output relay No.	01 to the number of alarm outputs 00H: No setting, 99: Dummy output Error code: 01H, 02H, 03H, 11H, 12H
46514	03 06 16	R W W	Calendar timer 1 Output mode	0: OR, 1: AND Error code: 01H, 02H, 03H, 11H, 12H
46516 to 46529	03 06 16	R W W	Calendar timer 2 Parameter	Same as calendar timer 1 parameters (46501 to 46514) Reference No.: Calendar timer 1 reference No. + 15
46531 to 46544	03 06 16	R W W	Calendar timer 3 Parameter	Same as calendar timer 1 parameters (46501 to 46514) Reference No.: Calendar timer 1 reference No. + 30
46546 to 46559	03 06 16	R W W	Calendar timer 4 Parameter	Same as calendar timer 1 parameters (46501 to 46514) Reference No.: Calendar timer 1 reference No. + 45

Reference No.	Applicable function code	R/W	Description	Details
46561 to 46574	03 06 16	R W W	Calendar timer 5 Parameter	Same as calendar timer 1 parameters (46501 to 46514) Reference No.: Calendar timer 1 reference No. + 60

## 5) Broken line approximation table

Reference No.	Applicable function code	R/W	Description	Details
47001	03 06 16	R W W	Broken line 1 Decimal point position of X axis factor	0 to 3 Error code: 01H, 02H, 03H, 09H, 11H, 12H
47002	03 06 16	R W W	Broken line 1 Decimal point position of Y axis factor	0 to 3 Error code: 01H, 02H, 03H, 09H, 11H, 12H
47003	03 06 16	R W W	Broken line 1 factor X1	-30000 to 30000 (Decimal point position of X axis is used.) -32768: The rest disabled Error code: 01H, 02H, 03H, 11H, 12H
47004	03 06 16	R W W	Broken line 1 factor Y1	-30000 to 30000 (Decimal point position of Y axis is used.) -32768: Disabled Error code: 01H, 02H, 03H, 11H, 12H
47005	03 06 16	R W W	Broken line 1 factor X2	-30000 to 30000 (Decimal point position of X axis is used.) -32768: The rest disabled Error code: 01H, 02H, 03H, 11H, 12H
47006	03 06 16	R W W	Broken line 1 factor Y2	-30000 to 30000 (Decimal point position of Y axis is used.) -32768: Disabled Error code: 01H, 02H, 03H, 11H, 12H
47007	03 06 16	R W W	Broken line 1 factor X3	-30000 to 30000 (Decimal point position of X axis is used.) -32768: The rest disabled Error code: 01H, 02H, 03H, 11H, 12H
47008	03 06 16	R W W	Broken line 1 factor Y3	-30000 to 30000 (Decimal point position of Y axis is used.) -32768: Disabled Error code: 01H, 02H, 03H, 11H, 12H
47009	03 06 16	R W W	Broken line 1 factor X4	-30000 to 30000 (Decimal point position of X axis is used.) -32768: The rest disabled Error code: 01H, 02H, 03H, 11H, 12H
47010	03 06 16	R W W	Broken line 1 factor Y4	-30000 to 30000 (Decimal point position of Y axis is used.) -32768: Disabled Error code: 01H, 02H, 03H, 11H, 12H
47011	03 06 16	R W W	Broken line 1 factor X5	-30000 to 30000 (Decimal point position of X axis is used.) -32768: The rest disabled Error code: 01H, 02H, 03H, 11H, 12H
47012	03 06 16	R W W	Broken line 1 factor Y5	-30000 to 30000 (Decimal point position of Y axis is used.) -32768: Disabled Error code: 01H, 02H, 03H, 11H, 12H
47013	03 06 16	R W W	Broken line 1 factor X6	-30000 to 30000 (Decimal point position of X axis is used.) -32768: The rest disabled Error code: 01H, 02H, 03H, 11H, 12H
47014	03 06 16	R W W	Broken line 1 factor Y6	-30000 to 30000 (Decimal point position of Y axis is used.) -32768: Disabled Error code: 01H, 02H, 03H, 11H, 12H

Reference No.	Applicable function code	R/W	Description	Details
47015	03 06 16	R W W	Broken line 1 factor X7	-30000 to 30000 (Decimal point position of X axis is used.) -32768: The rest disabled Error code: 01H, 02H, 03H, 11H, 12H
47016	03 06 16	R W W	Broken line 1 factor Y7	-30000 to 30000 (Decimal point position of Y axis is used.) -32768: Disabled Error code: 01H, 02H, 03H, 11H, 12H
47017	03 06 16	R W W	Broken line 1 factor X8	-30000 to 30000 (Decimal point position of X axis is used.) -32768: The rest disabled Error code: 01H, 02H, 03H, 11H, 12H
47018	03 06 16	R W W	Broken line 1 factor Y8	-30000 to 30000 (Decimal point position of Y axis is used.) -32768: Disabled Error code: 01H, 02H, 03H, 11H, 12H
47019	03 06 16	R W W	Broken line 1 factor X9	-30000 to 30000 (Decimal point position of X axis is used.) -32768: The rest disabled Error code: 01H, 02H, 03H, 11H, 12H
47020	03 06 16	R W W	Broken line 1 factor Y9	-30000 to 30000 (Decimal point position of Y axis is used.) -32768: Disabled Error code: 01H, 02H, 03H, 11H, 12H
47021	03 06 16	R W W	Broken line 1 factor X10	-30000 to 30000 (Decimal point position of X axis is used.) -32768: The rest disabled Error code: 01H, 02H, 03H, 11H, 12H
47022	03 06 16	R W W	Broken line 1 factor Y10	-30000 to 30000 (Decimal point position of Y axis is used.) -32768: Disabled Error code: 01H, 02H, 03H, 11H, 12H
47023	03 06 16	R W W	Broken line 1 factor X11	-30000 to 30000 (Decimal point position of X axis is used.) -32768: The rest disabled Error code: 01H, 02H, 03H, 11H, 12H
47024	03 06 16	R W W	Broken line 1 factor Y11	-30000 to 30000 (Decimal point position of Y axis is used.) -32768: Disabled Error code: 01H, 02H, 03H, 11H, 12H
47025	03 06 16	R W W	Broken line 1 factor X12	-30000 to 30000 (Decimal point position of X axis is used.) -32768: The rest disabled Error code: 01H, 02H, 03H, 11H, 12H
47026	03 06 16	R W W	Broken line 1 factor Y12	-30000 to 30000 (Decimal point position of Y axis is used.) -32768: Disabled Error code: 01H, 02H, 03H, 11H, 12H
47027	03 06 16	R W W	Broken line 1 factor X13	-30000 to 30000 (Decimal point position of X axis is used.) -32768: The rest disabled Error code: 01H, 02H, 03H, 11H, 12H
47028	03 06 16	R W W	Broken line 1 factor Y13	-30000 to 30000 (Decimal point position of Y axis is used.) -32768: Disabled Error code: 01H, 02H, 03H, 11H, 12H
47029	03 06 16	R W W	Broken line 1 factor X14	-30000 to 30000 (Decimal point position of X axis is used.) -32768: The rest disabled Error code: 01H, 02H, 03H, 11H, 12H
47030	03 06 16	R W W	Broken line 1 factor Y14	-30000 to 30000 (Decimal point position of Y axis is used.) -32768: Disabled Error code: 01H, 02H, 03H, 11H, 12H
47031	03 06 16	R W W	Broken line 1 factor X15	-30000 to 30000 (Decimal point position of X axis is used.) -32768: The rest disabled Error code: 01H, 02H, 03H, 11H, 12H
47032	03 06 16	R W W	Broken line 1 factor Y15	-30000 to 30000 (Decimal point position of Y axis is used.) -32768: Disabled Error code: 01H, 02H, 03H, 11H, 12H

Reference No.	Applicable function code	R/W	Description	Details
47033	03 06 16	R W W	Broken line 1 factor X16	-30000 to 30000 (Decimal point position of X axis is used.) -32768: The rest disabled Error code: 01H, 02H, 03H, 11H, 12H
47034	03 06 16	R W W	Broken line 1 factor Y16	-30000 to 30000 (Decimal point position of Y axis is used.) -32768: Disabled Error code: 01H, 02H, 03H, 11H, 12H
47035	03 06 16	R W W	Broken line 1 factor X17	-30000 to 30000 (Decimal point position of X axis is used.) -32768: The rest disabled Error code: 01H, 02H, 03H, 11H, 12H
47036	03 06 16	R W W	Broken line 1 factor Y17	-30000 to 30000 (Decimal point position of Y axis is used.) -32768: Disabled Error code: 01H, 02H, 03H, 11H, 12H
47037	03 06 16	R W W	Broken line 1 factor X18	-30000 to 30000 (Decimal point position of X axis is used.) -32768: The rest disabled Error code: 01H, 02H, 03H, 11H, 12H
47038	03 06 16	R W W	Broken line 1 factor Y18	-30000 to 30000 (Decimal point position of Y axis is used.) -32768: Disabled Error code: 01H, 02H, 03H, 11H, 12H
47039	03 06 16	R W W	Broken line 1 factor X19	-30000 to 30000 (Decimal point position of X axis is used.) -32768: The rest disabled Error code: 01H, 02H, 03H, 11H, 12H
47040	03 06 16	R W W	Broken line 1 factor Y19	-30000 to 30000 (Decimal point position of Y axis is used.) -32768: Disabled Error code: 01H, 02H, 03H, 11H, 12H
47041	03 06 16	R W W	Broken line 1 factor X20	-30000 to 30000 (Decimal point position of X axis is used.) -32768: The rest disabled Error code: 01H, 02H, 03H, 11H, 12H
47042	03 06 16	R W W	Broken line 1 factor Y20	-30000 to 30000 (Decimal point position of Y axis is used.) -32768: Disabled Error code: 01H, 02H, 03H, 11H, 12H
47043	03 06 16	R W W	Broken line 1 factor X21	-30000 to 30000 (Decimal point position of X axis is used.) -32768: The rest disabled Error code: 01H, 02H, 03H, 11H, 12H
47044	03 06 16	R W W	Broken line 1 factor Y21	-30000 to 30000 (Decimal point position of Y axis is used.) -32768: Disabled Error code: 01H, 02H, 03H, 11H, 12H
47045	03 06 16	R W W	Broken line 1 factor X22	-30000 to 30000 (Decimal point position of X axis is used.) -32768: The rest disabled Error code: 01H, 02H, 03H, 11H, 12H
47046	03 06 16	R W W	Broken line 1 factor Y22	-30000 to 30000 (Decimal point position of Y axis is used.) -32768: Disabled Error code: 01H, 02H, 03H, 11H, 12H
47047	03 06 16	R W W	Broken line 1 factor X23	-30000 to 30000 (Decimal point position of X axis is used.) -32768: The rest disabled Error code: 01H, 02H, 03H, 11H, 12H
47048	03 06 16	R W W	Broken line 1 factor Y23	-30000 to 30000 (Decimal point position of Y axis is used.) -32768: Disabled Error code: 01H, 02H, 03H, 11H, 12H
47049	03 06 16	R W W	Broken line 1 factor X24	-30000 to 30000 (Decimal point position of X axis is used.) -32768: The rest disabled Error code: 01H, 02H, 03H, 11H, 12H
47050	03 06 16	R W W	Broken line 1 factor Y24	-30000 to 30000 (Decimal point position of Y axis is used.) -32768: Disabled Error code: 01H, 02H, 03H, 11H, 12H

Reference No.	Applicable function code	R/W	Description	Details
47051	03 06 16	R W W	Broken line 1 factor X25	-30000 to 30000 (Decimal point position of X axis is used.) -32768: The rest disabled Error code: 01H, 02H, 03H, 11H, 12H
47052	03 06 16	R W W	Broken line 1 factor Y25	-30000 to 30000 (Decimal point position of Y axis is used.) -32768: Disabled Error code: 01H, 02H, 03H, 11H, 12H
47053	03 06 16	R W W	Broken line 1 factor X26	-30000 to 30000 (Decimal point position of X axis is used.) -32768: The rest disabled Error code: 01H, 02H, 03H, 11H, 12H
47054	03 06 16	R W W	Broken line 1 factor Y26	-30000 to 30000 (Decimal point position of Y axis is used.) -32768: Disabled Error code: 01H, 02H, 03H, 11H, 12H
47055	03 06 16	R W W	Broken line 1 factor X27	-30000 to 30000(Decimal point position of X axis is used.) -32768: The rest disabled Error code: 01H, 02H, 03H, 11H, 12H
47056	03 06 16	R W W	Broken line 1 factor Y27	-30000 to 30000(Decimal point position of Y axis is used.) -32768: Disabled Error code: 01H, 02H, 03H, 11H, 12H
47057	03 06 16	R W W	Broken line 1 factor X28	-30000 to 30000 (Decimal point position of X axis is used.) -32768: The rest disabled Error code: 01H, 02H, 03H, 11H, 12H
47058	03 06 16	R W W	Broken line 1 factor Y28	-30000 to 30000 (Decimal point position of Y axis is used.) -32768: Disabled Error code: 01H, 02H, 03H, 11H, 12H
47059	03 06 16	R W W	Broken line 1 factor X29	-30000 to 30000 (Decimal point position of X axis is used.) -32768: The rest disabled Error code: 01H, 02H, 03H, 11H, 12H
47060	03 06 16	R W W	Broken line 1 factor Y29	-30000 to 30000 (Decimal point position of Y axis is used.) -32768: Disabled Error code: 01H, 02H, 03H, 11H, 12H
47061	03 06 16	R W W	Broken line 1 factor X30	-30000 to 30000 (Decimal point position of X axis is used.) -32768: The rest disabled Error code: 01H, 02H, 03H, 11H, 12H
47062	03 06 16	R W W	Broken line 1 factor Y30	-30000 to 30000 (Decimal point position of Y axis is used.) -32768: Disabled Error code: 01H, 02H, 03H, 11H, 12H
47071 to 47132	03 06 16	R W W	Broken line 2 setting	Same as broken line 1 parameters (47001 to 47062) Reference No.: Broken line 1 reference No. + 70
47141 to 47201	03 06 16	R W W	Broken line 3 setting	Same as broken line 1 parameters (47001 to 47062) Reference No.: Broken line 1 reference No. + 140
47211 to 47272	03 06 16	R W W	Broken line 4 setting	Same as broken line 1 parameters (47001 to 47062) Reference No.: Broken line 1 reference No. + 210
47281 to 47342	03 06 16	R W W	Broken line 5 setting	Same as broken line 1 parameters (47001 to 47062) Reference No.: Broken line 1 reference No. + 280
47351 to 47412	03 06 16	R W W	Broken line 6 setting	Same as broken line 1 parameters (47001 to 47062) Reference No.: Broken line 1 reference No. + 350

## 6) SD card setting

R/W ... R: READ, W: WRITE

Reference No.	Applicable function code	R/W	Description	Details
47906	03 06 16	R W W	Recording to SD card Recording format	0: Binary, 1: Text, 2: Binary (floating decimal point), 4: Text (floating decimal point) Error code: 01H, 02H, 03H, 11H, 12H
47907	03 06 16	R W W	Recording to SD card Recording interval	0: 0.1sec, 1: 0.2sec, 2: 0.5sec, 3: 1sec, 4: 2sec, 5: 3sec (4sec), 6: 5sec (6sec), 7: 10sec, 8: 15sec (16sec), 9: 20sec, 10: 30sec, 11: 1min, 12: 2min, 13: 3min, 14: 5min, 15: 10min, 16: 15min, 17: 20min, 18: 30min, 19: 60min The value in () is for 12 points type and 24 points type Error code: 01H, 02H, 03H, 11H, 12H
47908	03 06 16	R W W	Recording to SD card Recording start trigger	0: None, 1: Key, 2: Specified time, 3: Linked to alarm output, 4: Linked to remote contact, 5: Linked to chart recording, 6: Linked to chart end, 7: Linked to calendar timer Error code: 01H, 02H, 03H, 11H, 12H
47909	03 06 16	R W W	Recording to SD card Recording start time (hour)	0 to 23 Error code: 01H, 02H, 03H, 11H, 12H
47910	03 06 16	R W W	Recording to SD card Recording start time (minute)	0 to 59 Error code: 01H, 02H, 03H, 11H, 12H
47911	03 06 16	R W W	Recording to SD card Recording end trigger	1: Key, 2: Specified time, 3: Linked to alarm output, 4: Linked to remote contact, 5: Linked to chart recording, 6: Linked to chart end, 7: Linked to calendar timer * Linked to alarm output/remote contact/chart recording/chart end/calendar timer can be selected only when the same has been selected for start trigger. Error code: 01H, 02H, 03H, 11H, 12H
47912	03 06 16	R W W	Recording to SD card Recording time (hour)	0 to 99 * This is enabled only when end trigger is set to Specified time. Error code: 01H, 02H, 03H, 11H, 12H
47913	03 06 16	R W W	Recording to SD card Recording time (minute)	0 to 59 * This is enabled only when end trigger is set to Specified time. Error code: 01H, 02H, 03H, 11H, 12H
47914	03 06 16	R W W	Recording to SD card Start condition 1	Start and end triggers Linked to alarm output: Output relay No. Linked to remote contact: Remote contact No.
47915	03 06 16	R W W	Recording to SD card Pre-trigger	0 to 10 Error code: 01H, 02H, 03H, 11H, 12H

## 7) Display order

R/W ... R: READ, W: WRITE

Reference No.	Applicable function code	R/W	Description	Details
47931	03	R	CH No. display order 1	0 to 24
	06	W		0: No CH specified
	16	W		Error code: 01H, 02H, 03H, 11H, 12H
47932	03	R	CH No. display order 2	0 to 24
	06	W		0: No CH specified
	16	W		Error code: 01H, 02H, 03H, 11H, 12H
47933	03	R	CH No. display order 3	0 to 24
	06	W		0: No CH specified
	16	W		Error code: 01H, 02H, 03H, 11H, 12H
47934	03	R	CH No. display order 4	0 to 24
	06	W		0: No CH specified
	16	W		Error code: 01H, 02H, 03H, 11H, 12H
47935	03	R	CH No. display order 5	0 to 24
	06	W		0: No CH specified
	16	W		Error code: 01H, 02H, 03H, 11H, 12H
47936	03	R	CH No. display order 6	0 to 24
	06	W		0: No CH specified
	16	W		Error code: 01H, 02H, 03H, 11H, 12H
47937	03	R	CH No. display order 7	0 to 24
	06	W		0: No CH specified
	16	W		Error code: 01H, 02H, 03H, 11H, 12H
47938	03	R	CH No. display order 8	0 to 24
	06	W		0: No CH specified
	16	W		Error code: 01H, 02H, 03H, 11H, 12H
47939	03	R	CH No. display order 9	0 to 24
	06	W		0: No CH specified
	16	W		Error code: 01H, 02H, 03H, 11H, 12H
47940	03	R	CH No. display order 10	0 to 24
	06	W		0: No CH specified
	16	W		Error code: 01H, 02H, 03H, 11H, 12H
47941	03	R	CH No. display order 11	0 to 24
	06	W		0: No CH specified
	16	W		Error code: 01H, 02H, 03H, 11H, 12H
47942	03	R	CH No. display order 12	0 to 24
	06	W		0: No CH specified
	16	W		Error code: 01H, 02H, 03H, 11H, 12H
47943	03	R	CH No. display order 13	0 to 24
	06	W		0: No CH specified
	16	W		Error code: 01H, 02H, 03H, 11H, 12H
47944	03	R	CH No. display order 14	0 to 24
	06	W		0: No CH specified
	16	W		Error code: 01H, 02H, 03H, 11H, 12H
47945	03	R	CH No. display order 15	0 to 24
	06	W		0: No CH specified
	16	W		Error code: 01H, 02H, 03H, 11H, 12H
47946	03	R	CH No. display order 16	0 to 24
	06	W		0: No CH specified
	16	W		Error code: 01H, 02H, 03H, 11H, 12H
47947	03	R	CH No. display order 17	0 to 24
	06	W		0: No CH specified
	16	W		Error code: 01H, 02H, 03H, 11H, 12H

Reference No.	Applicable function code	R/W	Description	Details
47948	03	R	CH No. display order 18	0 to 24
	06	W		0: No CH specified
	16	W		Error code: 01H, 02H, 03H, 11H, 12H
47949	03	R	CH No. display order 19	0 to 24
	06	W		0: No CH specified
	16	W		Error code: 01H, 02H, 03H, 11H, 12H
47950	03	R	CH No. display order 20	0 to 24
	06	W		0: No CH specified
	16	W		Error code: 01H, 02H, 03H, 11H, 12H
47951	03	R	CH No. display order 21	0 to 24
	06	W		0: No CH specified
	16	W		Error code: 01H, 02H, 03H, 11H, 12H
47952	03	R	CH No. display order 22	0 to 24
	06	W		0: No CH specified
	16	W		Error code: 01H, 02H, 03H, 11H, 12H
47953	03	R	CH No. display order 23	0 to 24
	06	W		0: No CH specified
	16	W		Error code: 01H, 02H, 03H, 11H, 12H
47954	03	R	CH No. display order 24	0 to 24
	06	W		0: No CH specified
	16	W		Error code: 01H, 02H, 03H, 11H, 12H



8) Title printing (message printing 2)

SR100 and SR200 enable printing up to 40 and 72 characters respectively through communication. This section shows the settings of printing characters.

Printing is executed with the title printing command of Reference No. 20.

R/W ... R: READ, W: WRITE

Reference No.	Applicable function code	R/W	Description	Details
48001	03	R	Title printing	1: Red, 2: Black, 3: Blue, 4: Green, 5: Brown, 6: Purple
	06	W	(Message printing 2)	
	16	W	Printing color	Error code: 01H, 02H, 03H, 11H, 12H
48002	03	R	Title printing	0: None
	06	W	(Message printing 2)	1: Used (Trace printing is interrupted to perform title printing.)
	16	W	Feed specification	Error code: 01H, 02H, 03H, 11H, 12H
48003	03	R	Title printing	ASCII 2 digits
	06	W	(Message printing 2)	* Characters after 00H are invalid.
	16	W	Printing character 1, 2	Error code: 01H, 02H, 03H, 11H, 12H
48004	03	R	Title printing	ASCII 2 digits
	06	W	(Message printing 2)	* Characters after 00H are invalid.
	16	W	Printing character 3, 4	Error code: 01H, 02H, 03H, 11H, 12H
48005	03	R	Title printing	ASCII 2 digits
	06	W	(Message printing 2)	* Characters after 00H are invalid.
	16	W	Printing character 5, 6	Error code: 01H, 02H, 03H, 11H, 12H
48006	03	R	Title printing	ASCII 2 digits
	06	W	(Message printing 2)	* Characters after 00H are invalid.
	16	W	Printing character 7, 8	Error code: 01H, 02H, 03H, 11H, 12H
48007	03	R	Title printing	ASCII 2 digits
	06	W	(Message printing 2)	* Characters after 00H are invalid.
	16	W	Printing character 9, 10	Error code: 01H, 02H, 03H, 11H, 12H
48008	03	R	Title printing	ASCII 2 digits
	06	W	(Message printing 2)	* Characters after 00H are invalid.
	16	W	Printing character 11, 12	Error code: 01H, 02H, 03H, 11H, 12H
48009	03	R	Title printing	ASCII 2 digits
	06	W	(Message printing 2)	* Characters after 00H are invalid.
	16	W	Printing character 13, 14	Error code: 01H, 02H, 03H, 11H, 12H
48010	03	R	Title printing	ASCII 2 digits
	06	W	(Message printing 2)	* Characters after 00H are invalid.
	16	W	Printing character 15, 16	Error code: 01H, 02H, 03H, 11H, 12H
48011	03	R	Title printing	ASCII 2 digits
	06	W	(Message printing 2)	* Characters after 00H are invalid.
	16	W	Printing character 17, 18	Error code: 01H, 02H, 03H, 11H, 12H
48012	03	R	Title printing	ASCII 2 digits
	06	W	(Message printing 2)	* Characters after 00H are invalid.
	16	W	Printing character 19, 20	Error code: 01H, 02H, 03H, 11H, 12H
48013	03	R	Title printing	ASCII 2 digits
	06	W	(Message printing 2)	* Characters after 00H are invalid.
	16	W	Printing character 21, 22	Error code: 01H, 02H, 03H, 11H, 12H
48014	03	R	Title printing	ASCII 2 digits
	06	W	(Message printing 2)	* Characters after 00H are invalid.
	16	W	Printing character 23, 24	Error code: 01H, 02H, 03H, 11H, 12H
48015	03	R	Title printing	ASCII 2 digits
	06	W	(Message printing 2)	* Characters after 00H are invalid.
	16	W	Printing character 25, 26	Error code: 01H, 02H, 03H, 11H, 12H
48016	03	R	Title printing	ASCII 2 digits
	06	W	(Message printing 2)	* Characters after 00H are invalid.
	16	W	Printing character 27, 28	Error code: 01H, 02H, 03H, 11H, 12H

Reference No.	Applicable function code	R/W	Description	Details
48017	03	R	Title printing	ASCII 2 digits
	06	W	(Message printing 2)	* Characters after 00H are invalid.
	16	W	Printing character 29, 30	Error code: 01H, 02H, 03H, 11H, 12H
48018	03	R	Title printing	ASCII 2 digits
	06	W	(Message printing 2)	* Characters after 00H are invalid.
	16	W	Printing character 31, 32	Error code: 01H, 02H, 03H, 11H, 12H
48019	03	R	Title printing	ASCII 2 digits
	06	W	(Message printing 2)	* Characters after 00H are invalid.
	16	W	Printing character 33, 34	Error code: 01H, 02H, 03H, 11H, 12H
48020	03	R	Title printing	ASCII 2 digits
	06	W	(Message printing 2)	* Characters after 00H are invalid.
	16	W	Printing character 35, 36	Error code: 01H, 02H, 03H, 11H, 12H
48021	03	R	Title printing	ASCII 2 digits
	06	W	(Message printing 2)	* Characters after 00H are invalid.
	16	W	Printing character 37, 38	Error code: 01H, 02H, 03H, 11H, 12H
48022	03	R	Title printing	ASCII 2 digits
	06	W	(Message printing 2)	* Characters after 00H are invalid.
	16	W	Printing character 39, 40	Error code: 01H, 02H, 03H, 11H, 12H
48023	03	R	Title printing	ASCII 2 digits
	06	W	(Message printing 2)	* Characters after 00H are invalid.
	16	W	Printing character 41, 42	Error code: 01H, 02H, 03H, 11H, 12H
48024	03	R	Title printing	ASCII 2 digits
	06	W	(Message printing 2)	* Characters after 00H are invalid.
	16	W	Printing character 43, 44	Error code: 01H, 02H, 03H, 11H, 12H
48025	03	R	Title printing	ASCII 2 digits
	06	W	(Message printing 2)	* Characters after 00H are invalid.
	16	W	Printing character 45, 46	Error code: 01H, 02H, 03H, 11H, 12H
48026	03	R	Title printing	ASCII 2 digits
	06	W	(Message printing 2)	* Characters after 00H are invalid.
	16	W	Printing character 47, 48	Error code: 01H, 02H, 03H, 11H, 12H
48027	03	R	Title printing	ASCII 2 digits
	06	W	(Message printing 2)	* Characters after 00H are invalid.
	16	W	Printing character 49, 50	Error code: 01H, 02H, 03H, 11H, 12H
48028	03	R	Title printing	ASCII 2 digits
	06	W	(Message printing 2)	* Characters after 00H are invalid.
	16	W	Printing character 51, 52	Error code: 01H, 02H, 03H, 11H, 12H
48029	03	R	Title printing	ASCII 2 digits
	06	W	(Message printing 2)	* Characters after 00H are invalid.
	16	W	Printing character 53, 54	Error code: 01H, 02H, 03H, 11H, 12H
48030	03	R	Title printing	ASCII 2 digits
	06	W	(Message printing 2)	* Characters after 00H are invalid.
	16	W	Printing character 55, 56	Error code: 01H, 02H, 03H, 11H, 12H
48031	03	R	Title printing	ASCII 2 digits
	06	W	(Message printing 2)	* Characters after 00H are invalid.
	16	W	Printing character 57, 58	Error code: 01H, 02H, 03H, 11H, 12H
48032	03	R	Title printing	ASCII 2 digits
	06	W	(Message printing 2)	* Characters after 00H are invalid.
	16	W	Printing character 59, 60	Error code: 01H, 02H, 03H, 11H, 12H
48033	03	R	Title printing	ASCII 2 digits
	06	W	(Message printing 2)	* Characters after 00H are invalid.
	16	W	Printing character 61, 62	Error code: 01H, 02H, 03H, 11H, 12H
48034	03	R	Title printing	ASCII 2 digits
	06	W	(Message printing 2)	* Characters after 00H are invalid.
	16	W	Printing character 63, 64	Error code: 01H, 02H, 03H, 11H, 12H

Reference No.	Applicable function code	R/W	Description	Details
48035	03	R	Title printing	ASCII 2 digits
	06	W	(Message printing 2)	* Characters after 00H are invalid.
	16	W	Printing character 65, 66	Error code: 01H, 02H, 03H, 11H, 12H
48036	03	R	Title printing	ASCII 2 digits
	06	W	(Message printing 2)	* Characters after 00H are invalid.
	16	W	Printing character 67, 68	Error code: 01H, 02H, 03H, 11H, 12H
48037	03	R	Title printing	ASCII 2 digits
	06	W	(Message printing 2)	* Characters after 00H are invalid.
	16	W	Printing character 69, 70	Error code: 01H, 02H, 03H, 11H, 12H
48038	03	R	Title printing	ASCII 2 digits
	06	W	(Message printing 2)	* Characters after 00H are invalid.
	16	W	Printing character 71, 72	Error code: 01H, 02H, 03H, 11H, 12H

9) Remote contact setting

R/W ... R: READ, W: WRITE

Reference No.	Applicable function code	R/W	Description	Details
48069	03 06 16	R W W	Remote contact 1 function	0: Unused, 1: Chart speed, 2: Message (1, 2), 3: Message (1 to 5), 8: Data printing, 9: List printing 1, 10: List printing 2, 11: List printing 3, 12: Integration reset, 13: Time correction, 101 to 120: Message printing (101:1 to 120:20) * When Chart speed is selected, remote contacts 1 and 2 should be set in the same way. * When Message (1, 2) is selected, remote contacts 1 and 2 should be set in the same way. * When Message (1 to 5) is selected, remote contacts 1 to 4 should all be set in the same way. Error code: 01H, 02H, 03H, 11H, 12H
48070	03 06 16	R W W	Remote contact 2 function	0: Unused, 1: Chart speed, 2: Message (1, 2), 3: Message (1 to 5), 8: Data printing, 9: List printing 1, 10: List printing 2, 11: List printing 3, 12: Integration reset, 13: Time correction, 101 to 120: Message printing (101:1 to 120:20) * When Chart speed is selected, remote contacts 1 and 2 should be set in the same way. * When Message (1, 2) is selected, remote contacts 1 and 2 should be set in the same way. * When Message (1 to 5) is selected, remote contacts 1 to 4 should all be set in the same way. Error code: 01H, 02H, 03H, 11H, 12H
48071	03 06 16	R W W	Remote contact 3 function	0: No function, 3: Message (1 to 5), 8: Data printing, 9: List printing 1, 10: List printing 2, 11: List printing 3, 12: Integration reset, 13: Time correction, 101 to 120: Message printing (101:1 to 120:20) * When Message (1 to 5) is selected, remote contacts 1 to 4 should all be set in the same way. Error code: 01H, 02H, 03H, 11H, 12H
48072	03 06 16	R W W	Remote contact 4 function	0: No function, 3: Message (1 to 5), 8: Data printing, 9: List printing 1, 10: List printing 2, 11: List printing 3, 12: Integration reset, 13: Time correction, 101 to 120: Message printing (101:1 to 120:20) * When Message (1 to 5) is selected, remote contacts 1 to 4 should all be set in the same way. Error code: 01H, 02H, 03H, 11H, 12H
48073	03 06 16	R W W	Remote contact 5 function	0: No function, 8: Data printing, 9: List printing 1, 10: List printing 2, 11: List printing 3, 12: Integration reset, 13: Time correction, 101 to 120: Message printing (101:1 to 120:20) Error code: 01H, 02H, 03H, 11H, 12H
48074	03 06 16	R W W	Remote contact 6 function	Same as remote contact 5
48075	03 06 16	R W W	Remote contact 7 function	Same as remote contact 5
48076	03 06 16	R W W	Remote contact 8 function	Same as remote contact 5

Reference No.	Applicable function code	R/W	Description	Details
48077	03 06 16	R W W	Remote contact 9 function	Same as remote contact 5
48078	03 06 16	R W W	Remote contact 10 function	Same as remote contact 5
48079	03 06 16	R W W	Remote contact 11 function	Same as remote contact 5
48080	03 06 16	R W W	Remote contact 12 function	Same as remote contact 5
48081	03 06 16	R W W	Remote contact 13 function	Same as remote contact 5
48082	03 06 16	R W W	Remote contact 14 function	Same as remote contact 5
48083	03 06 16	R W W	Remote contact 15 function	Same as remote contact 5
48084	03 06 16	R W W	Remote contact 16 function	Same as remote contact 5
48085	03 06 16	R W W	Remote contact 17 function	Same as remote contact 5
48086	03 06 16	R W W	Remote contact 18 function	Same as remote contact 5
48087	03 06 16	R W W	Remote contact 19 function	Same as remote contact 5
48088	03 06 16	R W W	Remote contact 20 function	Same as remote contact 5

## 10) Operation recording

R/W ... R: READ, W: WRITE

Reference No.	Applicable function code	R/W	Description	Details
48101	03 06 16	R W W	Operation recording 1 ON/OFF	0: OFF (operation recording disabled) 1: ON (operation recording enabled) Error code: 01H, 02H, 03H, 11H, 12H
48102	03 06 16	R W W	Operation recording 1 Recording position	0 to 90 Error code: 01H, 02H, 03H, 11H, 12H
48103	03 06 16	R W W	Operation recording 1 Line width	1 to 10 Error code: 01H, 02H, 03H, 11H, 12H
48104	03 06 16	R W W	Operation recording 1 Recording color	1: Red, 2: Black, 3: Blue, 4: Green, 5: Brown, 6: Purple Error code: 01H, 02H, 03H, 11H, 12H
48105 to 48108	03 06 16	R W W	Operation recording 2 Parameter	Same as operation recording 1 parameters (48101 to 48104)
48109 to 48112	03 06 16	R W W	Operation recording 3 Parameter	Same as operation recording 1 parameters (48101 to 48104)
48113 to 48116	03 06 16	R W W	Operation recording 4 Parameter	Same as operation recording 1 parameters (48101 to 48104)
48117 to 48120	03 06 16	R W W	Operation recording 5 Parameter	Same as operation recording 1 parameters (48101 to 48104)
48121 to 48124	03 06 16	R W W	Operation recording 6 Parameter	Same as operation recording 1 parameters (48101 to 48104)
48125 to 48128	03 06 16	R W W	Operation recording 7 Parameter	Same as operation recording 1 parameters (48101 to 48104)
48129 to 48132	03 06 16	R W W	Operation recording 8 Parameter	Same as operation recording 1 parameters (48101 to 48104)
48133 to 48136	03 06 16	R W W	Operation recording 9 Parameter	Same as operation recording 1 parameters (48101 to 48104)
48137 to 48140	03 06 16	R W W	Operation recording 10 Parameter	Same as operation recording 1 parameters (48101 to 48104)
48141 to 48144	03 06 16	R W W	Operation recording 11 Parameter	Same as operation recording 1 parameters (48101 to 48104)
48145 to 48148	03 06 16	R W W	Operation recording 12 Parameter	Same as operation recording 1 parameters (48101 to 48104)
48149 to 48152	03 06 16	R W W	Operation recording 13 Parameter	Same as operation recording 1 parameters (48101 to 48104)
48153 to 48156	03 06 16	R W W	Operation recording 14 Parameter	Same as operation recording 1 parameters (48101 to 48104)

Reference No.	Applicable function code	R/W	Description	Details
48157 to 48160	03 06 16	R W W	Operation recording 15 Parameter	Same as operation recording 1 parameters (48101 to 48104)
48161 to 48164	03 06 16	R W W	Operation recording 16 Parameter	Same as operation recording 1 parameters (48101 to 48104)
48165 to 48168	03 06 16	R W W	Operation recording 17 Parameter	Same as operation recording 1 parameters (48101 to 48104)
48169 to 48173	03 06 16	R W W	Operation recording 18 Parameter	Same as operation recording 1 parameters (48101 to 48104)
48174 to 48177	03 06 16	R W W	Operation recording 19 Parameter	Same as operation recording 1 parameters (48101 to 48104)
48178 to 48181	03 06 16	R W W	Operation recording 20 Parameter	Same as operation recording 1 parameters (48101 to 48104)

## 11) Message printing 1

Reference No.	Applicable function code	R/W	Description	Details
48202	03 06 16	R W W	Message printing 1 (1) Printing color	1: Red, 2: Black, 3: Blue, 4: Green, 5: Brown, 6: Purple Error code: 01H, 02H, 03H, 11H, 12H
48203	03 06 16	R R W	Message printing 1 (1) Printing character 1, 2	ASCII 2 digits * Characters after 00H are invalid. Error code: 01H, 02H, 03H, 11H, 12H
48204	03 06 16	R W W	Message printing 1 (1) Printing character 3, 4	ASCII 2 digits * Characters after 00H are invalid. Error code: 01H, 02H, 03H, 11H, 12H
48205	03 06 16	R W W	Message printing 1 (1) Printing character 5, 6	ASCII 2 digits * Characters after 00H are invalid. Error code: 01H, 02H, 03H, 11H, 12H
48206	03 06 16	R W W	Message printing 1 (1) Printing character 7, 8	ASCII 2 digits * Characters after 00H are invalid. Error code: 01H, 02H, 03H, 11H, 12H
48207	03 06 16	R W W	Message printing 1 (1) Printing character 9, 10	ASCII 2 digits * Characters after 00H are invalid. Error code: 01H, 02H, 03H, 11H, 12H
48208	03 06 16	R W W	Message printing 1 (1) Printing character 11, 12	ASCII 2 digits * Characters after 00H are invalid. Error code: 01H, 02H, 03H, 11H, 12H
48209	03 06 16	R W W	Message printing 1 (1) Printing character 13, 14	ASCII 2 digits * Characters after 00H are invalid. Error code: 01H, 02H, 03H, 11H, 12H
48210	03 06 16	R W W	Message printing 1 (1) Printing character 15	ASCII 2 digits * Characters after 00H are invalid. Error code: 01H, 02H, 03H, 11H, 12H
48212 to 48220	03 06 16	R W W	Message printing 1 (2) Parameter	Same as message printing 1 (1) parameters (48202 to 48210)

Reference No.	Applicable function code	R/W	Description	Details
48222 to 48230	03 06 16	R W W	Message printing 1 (3) Parameter	Same as message printing 1 (1) parameters (48202 to 48210)
48232 to 48240	03 06 16	R W W	Message printing 1 (4) Parameter	Same as message printing 1 (1) parameters (48202 to 48210)
48242 to 48250	03 06 16	R W W	Message printing 1 (5) Parameter	Same as message printing 1 (1) parameters (48202 to 48210)
48252 to 48260	03 06 16	R W W	Message printing 1 (6) Parameter	Same as message printing 1 (1) parameters (48202 to 48210)
48262 to 48270	03 06 16	R W W	Message printing 1 (7) Parameter	Same as message printing 1 (1) parameters (48202 to 48210)
48272 to 48280	03 06 16	R W W	Message printing 1 (8) Parameter	Same as message printing 1 (1) parameters (48202 to 48210)
48282 to 48290	03 06 16	R W W	Message printing 1 (9) Parameter	Same as message printing 1 (1) parameters (48202 to 48210)
48292 to 48300	03 06 16	R W W	Message printing 1 (10) Parameter	Same as message printing 1 (1) parameters (48202 to 48210)
48302 to 48310	03 06 16	R W W	Message printing 1 (11) Parameter	Same as message printing 1 (1) parameters (48202 to 48210)
48312 to 48320	03 06 16	R W W	Message printing 1 (12) Parameter	Same as message printing 1 (1) parameters (48202 to 48210)
48322 to 48330	03 06 16	R W W	Message printing 1 (13) Parameter	Same as message printing 1 (1) parameters (48202 to 48210)
48332 to 48340	03 06 16	R W W	Message printing 1 (14) Parameter	Same as message printing 1 (1) parameters (48202 to 48210)
48342 to 48350	03 06 16	R W W	Message printing 1 (15) Parameter	Same as message printing 1 (1) parameters (48202 to 48210)
48352 to 48360	03 06 16	R W W	Message printing 1 (16) Parameter	Same as message printing 1 (1) parameters (48202 to 48210)
48362 to 48370	03 06 16	R W W	Message printing 1 (17) Parameter	Same as message printing 1 (1) parameters (48202 to 48210)
48372 to 48380	03 06 16	R W W	Message printing 1 (18) Parameter	Same as message printing 1 (1) parameters (48202 to 48210)
48382 to 48390	03 06 16	R W W	Message printing 1 (19) Parameter	Same as message printing 1 (1) parameters (48202 to 48210)
48392 to 48400	03 06 16	R W W	Message printing 1 (20) Parameter	Same as message printing 1 (1) parameters (48202 to 48210)



12) Periodic data printing (printing at specified time)

R/W ... R: READ, W: WRITE

Reference No.	Applicable function code	R/W	Description	Details
48501	03 06 16	R W W	Printing at specified time1 to 24 ON/OFF	0: OFF (printing at specified time disabled) 1: ON (printing at specified time enabled)
48502	03 06 16	R W W	Specified time 1 (Hour)	0 to 23 25: Unused Error code: 01H, 02H, 03H, 11H, 12H
48503	03 06 16	R W W	Specified time 1 (Minute)	0 to 59 60: Unused Error code: 01H, 02H, 03H, 11H, 12H
48504 48505	03 06 16	R W W	Specified time 2 Parameter	Same as specified time 1 parameters (48502, 48503)
48506 48507	03 06 16	R W W	Specified time 3 Parameter	Same as specified time 1 parameters (48502, 48503)
48508 48509	03 06 16	R W W	Specified time 4 Parameter	Same as specified time 1 parameters (48502, 48503)
48510 48511	03 06 16	R W W	Specified time 5 Parameter	Same as specified time 1 parameters (48502, 48503)
48512 48513	03 06 16	R W W	Specified time 6 Parameter	Same as specified time 1 parameters (48502, 48503)
48514 48515	03 06 16	R W W	Specified time 7 Parameter	Same as specified time 1 parameters (48502, 48503)
48516 48517	03 06 16	R W W	Specified time 8 Parameter	Same as specified time 1 parameters (48502, 48503)
48518 48519	03 06 16	R W W	Specified time 9 Parameter	Same as specified time 1 parameters (48502, 48503)
48520 48521	03 06 16	R W W	Specified time 10 Parameter	Same as specified time 1 parameters (48502, 48503)
48522 48523	03 06 16	R W W	Specified time 11 Parameter	Same as specified time 1 parameters (48502, 48503)
48524 48525	03 06 16	R W W	Specified time 12 Parameter	Same as specified time 1 parameters (48502, 48503)
48526 48527	03 06 16	R W W	Specified time 13 Parameter	Same as specified time 1 parameters (48502, 48503)
48528 48529	03 06 16	R W W	Specified time 14 Parameter	Same as specified time 1 parameters (48502, 48503)
48530 48531	03 06 16	R W W	Specified time 15 Parameter	Same as specified time 1 parameters (48502, 48503)

Reference No.	Applicable function code	R/W	Description	Details
48532 48533	03 06 16	R W W	Specified time 16 Parameter	Same as specified time 1 parameters (48502, 48503)
48534 48535	03 06 16	R W W	Specified time 17 Parameter	Same as specified time 1 parameters (48502, 48503)
48536 48537	03 06 16	R W W	Specified time 18 Parameter	Same as specified time 1 parameters (48502, 48503)
48538 48539	03 06 16	R W W	Specified time 19 Parameter	Same as specified time 1 parameters (48502, 48503)
48540 48541	03 06 16	R W W	Specified time 20 Parameter	Same as specified time 1 parameters (48502, 48503)
48542 48543	03 06 16	R W W	Specified time 21 Parameter	Same as specified time 1 parameters (48502, 48503)
48544 48545	03 06 16	R W W	Specified time 22 Parameter	Same as specified time 1 parameters (48502, 48503)
48546 48547	03 06 16	R W W	Specified time 23 Parameter	Same as specified time 1 parameters (48502, 48503)
48548 48549	03 06 16	R W W	Specified time 24 Parameter	Same as specified time 1 parameters (48502, 48503)

## 13) Formula

Reference No.	Applicable function code	R/W	Description	Details
48601	03 06 16	R W W	Formula 1 Character string 1, 2	ASCII 2 digits * Characters after 00H are invalid. Error code: 01H, 02H, 03H, 11H, 12H
48602	03 06 16	R W W	Formula 1 Character string 3, 4	ASCII 2 digits * Characters after 00H are invalid. Error code: 01H, 02H, 03H, 11H, 12H
48603	03 06 16	R W W	Formula 1 Character string 5, 6	ASCII 2 digits * Characters after 00H are invalid. Error code: 01H, 02H, 03H, 11H, 12H
48604	03 06 16	R W W	Formula 1 Character string 7, 8	ASCII 2 digits * Characters after 00H are invalid. Error code: 01H, 02H, 03H, 11H, 12H
48605	03 06 16	R W W	Formula 1 Character string 9, 10	ASCII 2 digits * Characters after 00H are invalid. Error code: 01H, 02H, 03H, 11H, 12H
48606	03 06 16	R W W	Formula 1 Character string 11, 12	ASCII 2 digits * Characters after 00H are invalid. Error code: 01H, 02H, 03H, 11H, 12H
48607	03 06 16	R W W	Formula 1 Character string 13, 14	ASCII 2 digits * Characters after 00H are invalid. Error code: 01H, 02H, 03H, 11H, 12H

Reference No.	Applicable function code	R/W	Description	Details
48608	03	R	Formula 1 Character string 15, 16	ASCII 2 digits * Characters after 00H are invalid. Error code: 01H, 02H, 03H, 11H, 12H
	06	W		
	16	W		
48609	03	R	Formula 1 Character string 17, 18	ASCII 2 digits * Characters after 00H are invalid. Error code: 01H, 02H, 03H, 11H, 12H
	06	W		
	16	W		
48610	03	R	Formula 1 Character string 19, 20	ASCII 2 digits * Characters after 00H are invalid. Error code: 01H, 02H, 03H, 11H, 12H
	06	W		
	16	W		
48611	03	R	Formula 1 Character string 21, 22	ASCII 2 digits * Characters after 00H are invalid. Error code: 01H, 02H, 03H, 11H, 12H
	06	W		
	16	W		
48612	03	R	Formula 1 Character string 23, 24	ASCII 2 digits * Characters after 00H are invalid. Error code: 01H, 02H, 03H, 11H, 12H
	06	W		
	16	W		
48613	03	R	Formula 1 Character string 25, 26	ASCII 2 digits * Characters after 00H are invalid. Error code: 01H, 02H, 03H, 11H, 12H
	06	W		
	16	W		
48614	03	R	Formula 1 Character string 27, 28	ASCII 2 digits * Characters after 00H are invalid. Error code: 01H, 02H, 03H, 11H, 12H
	06	W		
	16	W		
48615	03	R	Formula 1 Character string 29, 30	ASCII 2 digits * Characters after 00H are invalid. Error code: 01H, 02H, 03H, 11H, 12H
	06	W		
	16	W		
48616	03	R	Formula 1 Character string 31, 32	ASCII 2 digits * Characters after 00H are invalid. Error code: 01H, 02H, 03H, 11H, 12H
	06	W		
	16	W		
48617	03	R	Formula 1 Character string 33, 34	ASCII 2 digits * Characters after 00H are invalid. Error code: 01H, 02H, 03H, 11H, 12H
	06	W		
	16	W		
48618	03	R	Formula 1 Character string 35, 36	ASCII 2 digits * Characters after 00H are invalid. Error code: 01H, 02H, 03H, 11H, 12H
	06	W		
	16	W		
48619	03	R	Formula 1 Character string 37, 38	ASCII 2 digits * Characters after 00H are invalid. Error code: 01H, 02H, 03H, 11H, 12H
	06	W		
	16	W		
48620	03	R	Formula 1 Character string 39, 40	ASCII 2 digits * Characters after 00H are invalid. Error code: 01H, 02H, 03H, 11H, 12H
	06	W		
	16	W		
48621	03	R	Formula 1 Character string 41, 42	ASCII 2 digits * Characters after 00H are invalid. Error code: 01H, 02H, 03H, 11H, 12H
	06	W		
	16	W		
48622	03	R	Formula 1 Character string 43, 44	ASCII 2 digits * Characters after 00H are invalid. Error code: 01H, 02H, 03H, 11H, 12H
	06	W		
	16	W		
48623	03	R	Formula 1 Character string 45, 46	ASCII 2 digits * Characters after 00H are invalid. Error code: 01H, 02H, 03H, 11H, 12H
	06	W		
	16	W		
48624	03	R	Formula 1 Character string 47, 48	ASCII 2 digits * Characters after 00H are invalid. Error code: 01H, 02H, 03H, 11H, 12H
	06	W		
	16	W		
48625	03	R	Formula 1 Character string 49, 50	ASCII 2 digits * Characters after 00H are invalid. Error code: 01H, 02H, 03H, 11H, 12H
	06	W		
	16	W		

Reference No.	Applicable function code	R/W	Description	Details
48626 to 48650	03 06 16	R W W	Formula 2 Character string	Same as formula 1 parameters (48601 to 48625)
48651 to 48675	03 06 16	R W W	Formula 3 Character string	Same as formula 1 parameters (48601 to 48625)
48676 to 48700	03 06 16	R W W	Formula 4 Character string	Same as formula 1 parameters (48601 to 48625)
48701 to 48725	03 06 16	R W W	Formula 5 Character string	Same as formula 1 parameters (48601 to 48625)
48726 to 48750	03 06 16	R W W	Formula 6 Character string	Same as formula 1 parameters (48601 to 48625)
48751 to 48775	03 06 16	R W W	Formula 7 Character string	Same as formula 1 parameters (48601 to 48625)
48776 to 48800	03 06 16	R W W	Formula 8 Character string	Same as formula 1 parameters (48601 to 48625)
48801 to 48825	03 06 16	R W W	Formula 9 Character string	Same as formula 1 parameters (48601 to 48625)
48826 to 48850	03 06 16	R W W	Formula 10 Character string	Same as formula 1 parameters (48601 to 48625)
48851 to 48875	03 06 16	R W W	Formula 11 Character string	Same as formula 1 parameters (48601 to 48625)
48876 to 48900	03 06 16	R W W	Formula 12 Character string	Same as formula 1 parameters (48601 to 48625)

## 14) Data communications input

R/W ... W: WRITE

Reference No.	Applicable function code	R/W	Description	Details
49001	06 16	W W	Data communications input CH1 data	DATA:-30000 to 32763 32767: + Over range -32767: - Over range 32766: Burnout Error code: 01H, 02H, 03H, 11H, 12H
49002	06 16	W W	Data communications input CH1 decimal point	0 to 3 Error code: 01H, 02H, 03H, 11H, 12H
49003	06 16	W W	Data communications input CH2 data	Same as CH1
49004	06 16	W W	Data communications input CH2 decimal point	Same as CH1
49005	06 16	W W	Data communications input CH3 data	Same as CH1
49006	06 16	W W	Data communications input CH3 decimal point	Same as CH1
49007	06 16	W W	Data communications input CH4 data	Same as CH1
49008	06 16	W W	Data communications input CH4 decimal point	Same as CH1
49009	06 16	W W	Data communications input CH5 data	Same as CH1
49010	06 16	W W	Data communications input CH5 decimal point	Same as CH1
49011	06 16	W W	Data communications input CH6 data	Same as CH1
49012	06 16	W W	Data communications input CH6 decimal point	Same as CH1
49013	06 16	W W	Data communications input CH7 data	Same as CH1
49014	06 16	W W	Data communications input CH7 decimal point	Same as CH1
49015	06 16	W W	Data communications input CH8 data	Same as CH1
49016	06 16	W W	Data communications input CH8 decimal point	Same as CH1
49017	06 16	W W	Data communications input CH9 data	Same as CH1
49018	06 16	W W	Data communications input CH9 decimal point	Same as CH1
49019	06 16	W W	Data communications input CH10 data	Same as CH1
49020	06 16	W W	Data communications input CH10 decimal point	Same as CH1
49021	06 16	W W	Data communications input CH11 data	Same as CH1
49022	06 16	W W	Data communications input CH11 decimal point	Same as CH1
49023	06 16	W W	Data communications input CH12 data	Same as CH1
49024	06 16	W W	Data communications input CH12 decimal point	Same as CH1

Reference No.	Applicable function code	R/W	Description	Details
49025	06 16	W W	Data communications input CH13 data	Same as CH1
49026	06 16	W W	Data communications input CH13 decimal point	Same as CH1
49027	06 16	W W	Data communications input CH14 data	Same as CH1
49028	06 16	W W	Data communications input CH14 decimal point	Same as CH1
49029	06 16	W W	Data communications input CH15 data	Same as CH1
49030	06 16	W W	Data communications input CH15 decimal point	Same as CH1
49031	06 16	W W	Data communications input CH16 data	Same as CH1
49032	06 16	W W	Data communications input CH16 decimal point	Same as CH1
49033	06 16	W W	Data communications input CH17 data	Same as CH1
49034	06 16	W W	Data communications input CH17 decimal point	Same as CH1
49035	06 16	W W	Data communications input CH18 data	Same as CH1
49036	06 16	W W	Data communications input CH18 decimal point	Same as CH1
49037	06 16	W W	Data communications input CH19 data	Same as CH1
49038	06 16	W W	Data communications input CH19 decimal point	Same as CH1
49039	06 16	W W	Data communications input CH20 data	Same as CH1
49040	06 16	W W	Data communications input CH20 decimal point	Same as CH1
49041	06 16	W W	Data communications input CH21 data	Same as CH1
49042	06 16	W W	Data communications input CH21 decimal point	Same as CH1
49043	06 16	W W	Data communications input CH22 data	Same as CH1
49044	06 16	W W	Data communications input CH22 decimal point	Same as CH1
49045	06 16	W W	Data communications input CH23 data	Same as CH1
49046	06 16	W W	Data communications input CH23 decimal point	Same as CH1
49047	06 16	W W	Data communications input CH24 data	Same as CH1
49048	06 16	W W	Data communications input CH24 decimal point	Same as CH1

## 15) Fail out

R/W ... R: READ, W: WRITE

Reference No.	Applicable function code	R/W	Description	Details
49101	03 06 16	R W W	Chart END Alarm operation	Perform OR operation on a required item from the followings: 0x0001: LCD display*, 0x0002: LED indication, 0x0004: Relay output, 0x0008: Mail* Error code: 01H, 02H, 03H, 11H, 12H
49102	03 06 16	R W W	Chart END Alarm output No.	1 to 24 0: No output, 99: Dummy output Error code: 01H, 02H, 03H, 11H, 12H
49103	03 06 16	R W W	Chart END Alarm output mode	0: OR, 1: AND Error code: 01H, 02H, 03H, 11H, 12H
49105	03 06 16	R W W	Input disconnection Alarm operation	Perform OR operation on a required item from the followings: 0x0001: LCD display*, 0x0002: LED indication, 0x0004: Relay output, 0x0008: Mail* Error code: 01H, 02H, 03H, 11H, 12H
49106	03 06 16	R W W	Input disconnection Alarm output No.	1 to 24 0: No output, 99: Dummy output Error code: 01H, 02H, 03H, 11H, 12H
49107	03 06 16	R W W	Input disconnection Alarm output mode	0: OR, 1: AND Error code: 01H, 02H, 03H, 11H, 12H
49109	03 06 16	R W W	SD card capacity low Alarm operation	Perform OR operation on a required item from the followings: 0x0001: LCD display*, 0x0002: LED indication, 0x0004: Relay output, 0x0008: Mail* Error code: 01H, 02H, 03H, 11H, 12H
49110	03 06 16	R W W	SD card capacity low Alarm output No.	1 to 24 0: No output, 99: Dummy output Error code: 01H, 02H, 03H, 11H, 12H
49111	03 06 16	R W W	SD card capacity low Alarm output mode	0: OR, 1: AND Error code: 01H, 02H, 03H, 11H, 12H
49113	03 06 16	R W W	Backup battery Low level alarm operation	Perform OR operation on a required item from the followings: 0x0001: LCD display*, 0x0002: LED indication, 0x0004: Relay output, 0x0008: Mail* Error code: 01H, 02H, 03H, 11H, 12H
49114	03 06 16	R W W	Backup battery Low level alarm output	1 to 24 0: No output, 99: Dummy output Error code: 01H, 02H, 03H, 11H, 12H
49115	03 06 16	R W W	Backup battery Alarm output mode	0: OR, 1: AND Error code: 01H, 02H, 03H, 11H, 12H
49117	03 06 16	R W W	System error Alarm operation	Perform OR operation on a required item from the followings: 0x0001: LCD display*, 0x0002: LED indication, 0x0004: Relay output, 0x0008: Mail* Error code: 01H, 02H, 03H, 11H, 12H
49118	03 06 16	R W W	System error Alarm output No.	1 to 24 0: No output, 99: Dummy output Error code: 01H, 02H, 03H, 11H, 12H
49119	03 06 16	R W W	System error Alarm output mode	0: OR, 1: AND Error code: 01H, 02H, 03H, 11H, 12H

## 16) Communication parameters

R/W ... R: READ, W: WRITE

Reference No.	Applicable function code	R/W	Description	Details
49902	03 06 16	R W W	COM1 Communication mode	0: The unit is slave. Error code: 01H, 02H, 03H, 11H, 12H
49903	03 06 16	R W W	COM1 Protocol	1: MODBUS RTU, 2: MODBUS ASCII, 3: PRIVATE1 (without connection sequence/communication address), 4: PRIVATE2 (with connection sequence/communication address) Error code: 01H, 02H, 03H, 11H, 12H
49904	03 06 16	R W W	COM1 Communication address	1 to 99 Error code: 01H, 02H, 03H, 11H, 12H
49905	03 06 16	R W W	COM1 Transmission speed	1: 1200, 2: 2400, 3: 4800, 4: 9600, 5: 19200, 6: 38400 Error code: 01H, 02H, 03H, 11H, 12H
49906	03 06 16	R W W	COM1 Transmission character	1: 7E1, 2: 7E2, 3: 7O1, 4: 7O2, 5: 8N1, 6: 8N2, 7: 8E1, 8: 8E2, 9: 8O1, 10: 8O2 Error code: 01H, 02H, 03H, 11H, 12H
49907	03 06 16	R W W	COM1 Checksum	0: None, 1: Used * This is enabled only when Protocol is set to PRIVATE. Error code: 01H, 02H, 03H, 11H, 12H
49912	03 06 16	R W W	COM2 Communication mode	0: The unit is slave. Error code: 01H, 02H, 03H, 11H, 12H
49913	03 06 16	R W W	COM2 Protocol	1: MODBUS RTU, 2: MODBUS ASCII, 3: PRIVATE1 (without connection sequence), 4: PRIVATE2 (with connection sequence) Error code: 01H, 02H, 03H, 11H, 12H
49914	03 06 16	R W W	COM2 Communication address	1 to 99 Error code: 01H, 02H, 03H, 11H, 12H
49915	03 06 16	R W W	COM2 Transmission speed	1: 1200, 2: 2400, 3: 4800, 4: 9600, 5: 19200, 6: 38400 Error code: 01H, 02H, 03H, 11H, 12H
49916	03 06 16	R W W	COM2 Transmission character	1: 7E1, 2: 7E2, 3: 7O1, 4: 7O2, 5: 8N1, 6: 8N2, 7: 8E1, 8: 8E2, 9: 8O1, 10: 8O2 Error code: 01H, 02H, 03H, 11H, 12H
49917	03 06 16	R W W	COM2 Checksum	0: None, 1: Used * This is enabled only when Protocol is set to PRIVATE. Error code: 01H, 02H, 03H, 11H, 12H
49922	03 06 16	R W W	USB Connection mode	0: BULK Error code: 01H, 02H, 03H, 11H, 12H
49923	03 06 16	R W W	USB Identification data	1 to 5 Error code: 01H, 02H, 03H, 11H, 12H



## 5. Floating data

### 1) Measured data

R/W ... R: READ

Reference No.	Applicable function code	R/W	Description	Details
50101	70	R	CH1 data	DATA:-30000 to 99999 +100000: + Over range -100000: - Over range +200000: Burnout -200000: Invalid data 400000: Calculation error Error code: 01H, 02H, 03H, 12H
50102	70	R	CH2 data	Same as CH1
50103	70	R	CH3 data	Same as CH1
50104	70	R	CH4 data	Same as CH1
50105	70	R	CH5 data	Same as CH1
50106	70	R	CH6 data	Same as CH1
50107	70	R	CH7 data	Same as CH1
50108	70	R	CH8 data	Same as CH1
50109	70	R	CH9 data	Same as CH1
50110	70	R	CH10 data	Same as CH1
50111	70	R	CH11 data	Same as CH1
50112	70	R	CH12 data	Same as CH1
50113	70	R	CH13 data	Same as CH1
50114	70	R	CH14 data	Same as CH1
50115	70	R	CH15 data	Same as CH1
50116	70	R	CH16 data	Same as CH1
50117	70	R	CH17 data	Same as CH1
50118	70	R	CH18 data	Same as CH1
50119	70	R	CH19 data	Same as CH1
50120	70	R	CH20 data	Same as CH1
50121	70	R	CH21 data	Same as CH1
50122	70	R	CH22 data	Same as CH1
50123	70	R	CH23 data	Same as CH1
50124	70	R	CH24 data	Same as CH1

### 2) Data communications input

R/W ... W: WRITE

Reference No.	Applicable function code	R/W	Description	Details
50201	71	W	Data communications input CH1 input data	DATA:-30000 to 99999 +100000: + Over range -100000: - Over range +200000: Burnout -200000: Invalid data 400000: Calculation error Error code: 01H, 02H, 03H, 12H
50202	71	W	CH2 data	Same as CH1
50203	71	W	CH3 data	Same as CH1
50204	71	W	CH4 data	Same as CH1
50205	71	W	CH5 data	Same as CH1
50206	71	W	CH6 data	Same as CH1
50207	71	W	CH7 data	Same as CH1
50208	71	W	CH8 data	Same as CH1

Reference No.	Applicable function code	R/W	Description	Details
50209	71	W	CH9 data	Same as CH1
50210	71	W	CH10 data	Same as CH1
50211	71	W	CH11 data	Same as CH1
50212	71	W	CH12 data	Same as CH1
50213	71	W	CH13 data	Same as CH1
50214	71	W	CH14 data	Same as CH1
50215	71	W	CH15 data	Same as CH1
50216	71	W	CH16 data	Same as CH1
50217	71	W	CH17 data	Same as CH1
50218	71	W	CH18 data	Same as CH1
50219	71	W	CH19 data	Same as CH1
50220	71	W	CH20 data	Same as CH1
50221	71	W	CH21 data	Same as CH1
50222	71	W	CH22 data	Same as CH1
50223	71	W	CH23 data	Same as CH1
50224	71	W	CH24 data	Same as CH1

## 3) Parameters set by each channel

Note: Writing multiple set values across channels will be an error (error code: 12H).

R/W ... R: READ, W: WRITE

Reference No.	Applicable function code	R/W	Description	Details
50301	70	R	CH1 range lower limit	-30000 to 30000
	71	W		Error code: 01H, 02H, 03H, 12H
50302	70	R	CH1 range upper limit	-30000 to 30000
	71	W		Error code: 01H, 02H, 03H, 12H
50303	70	R	CH1 range decimal point	0 to 3 (Both range upper and lower limits use the same decimal point position.)
	71	W		Error code: 01H, 02H, 03H, 12H
50304	70	R	CH1 scale lower limit	-30000 to 99999
	71	W		Error code: 01H, 02H, 03H, 12H
50305	70	R	CH1 scale upper limit	-30000 to 99999
	71	W		Error code: 01H, 02H, 03H, 12H
50306	70	R	CH1 scale decimal point	0 to 3 (Both scale upper and lower limits use the same decimal point position.)
	71	W		Error code: 01H, 02H, 03H, 12H
50307	70	R	CH1 level 1 Alarm value	-30000 to 99999 (Decimal point position of scale is used.)
	71	W		Error code: 01H, 02H, 03H, 12H
50308	70	R	CH1 level 2 Alarm value	-30000 to 99999 (Decimal point position of scale is used.)
	71	W		Error code: 01H, 02H, 03H, 12H
50309	70	R	CH1 level 3 Alarm value	-30000 to 99999 (Decimal point position of scale is used.)
	71	W		Error code: 01H, 02H, 03H, 12H
50310	70	R	CH1 level 4 Alarm value	-30000 to 99999 (Decimal point position of scale is used.)
	71	W		Error code: 01H, 02H, 03H, 12H
50313	70	R	CH1 recording range Lower limit	-30000 to 99999
	71	W		Error code: 01H, 02H, 03H, 12H

Reference No.	Applicable function code	R/W	Description	Details
50314	70 71	R W	CH1 recording range Upper limit	-30000 to 99999 Error code: 01H, 02H, 03H, 12H
50315	70 71	R W	CH1 recording range Decimal point	0 to 3 (Both recording range upper and lower limits use the same decimal point position.) Error code: 01H, 02H, 03H, 12H
50316	70 71	R W	CH1 calculation constant A	-30000 to 99999 Error code: 01H, 02H, 03H, 12H
50317	70 71	R W	CH1 calculation constant A Decimal point	0 to 3 Error code: 01H, 02H, 03H, 12H
50318	70 71	R W	CH1 calculation constant B	-30000 to 99999 Error code: 01H, 02H, 03H, 12H
50319	70 71	R W	CH1 calculation constant B Decimal point	0 to 3 Error code: 01H, 02H, 03H, 12H
50320	70 71	R W	CH1 calculation constant C	-30000 to 99999 Error code: 01H, 02H, 03H, 12H
50321	70 71	R W	CH1 calculation constant C Decimal point	0 to 3 Error code: 01H, 02H, 03H, 12H
50322	70 71	R W	CH1 calculation constant D	-30000 to 99999 Error code: 01H, 02H, 03H, 12H
50323	70 71	R W	CH1 calculation constant D Decimal point	0 to 3 Error code: 01H, 02H, 03H, 12H
50325	70 71	R W	CH1 compressed/ expanded printing 0% value	-30000 to 99999 (Decimal point position of recording range is used.) Error code: 01H, 02H, 03H, 12H
50326	70 71	R W	CH1 compressed/ expanded printing 1st break point %	0 to 99 0: Unused Error code: 01H, 02H, 03H, 12H
50327	70 71	R W	CH1 compressed/ expanded printing 1st break point value	-30000 to 99999 (Decimal point position of recording range is used.) Error code: 01H, 02H, 03H, 12H
50328	70 71	R W	CH1 compressed/ expanded printing 2nd break point %	1 to 99 0: Unused Error code: 01H, 02H, 03H, 12H
50329	70 71	R W	CH1 compressed/ expanded printing 2nd break point value	-30000 to 99999 (Decimal point position of recording range is used.) Error code: 01H, 02H, 03H, 12H
50330	70 71	R W	CH1 compressed/ expanded printing 100% value	-30000 to 99999 (Decimal point position of recording range is used.) Error code: 01H, 02H, 03H, 12H
50332	70 71	R W	CH1 subtract printing reference value	-30000 to 99999(Decimal point position of scale of reference CH is used.) * This is enabled when subtraction CH is not set.
50333	70 71	R W	CH1 subtract printing range Lower limit	-30000 to 99999 (Decimal point position of recording range is used.) Error code: 01H, 02H, 03H, 12H
50334	70 71	R W	CH1 subtract printing range Upper limit	-9999 to 99999 (Decimal point position of recording range is used.) Error code: 01H, 02H, 03H, 12H

Reference No.	Applicable function code	R/W	Description	Details
50337	70 71	R W	CH1 automatic range-shift 1st range lower limit	-30000 to 99999 -32768: No setting (Decimal point position of recording range is used.) Error code: 01H, 02H, 03H, 12H
50338	70 71	R W	CH1 automatic range-shift 1st range upper limit	-30000 to 99999 -32768: No setting (Decimal point position of recording range is used.) Error code: 01H, 02H, 03H, 12H
50339	70 71	R W	CH1 automatic range-shift 2nd range upper limit	-30000 to 99999 -32768: No setting (Decimal point position of recording range is used.) Error code: 01H, 02H, 03H, 12H
50340	70 71	R W	CH1 automatic range-shift 3rd range upper limit	-30000 to 99999 -32768: No setting (Decimal point position of recording range is used.) Error code: 01H, 02H, 03H, 12H
50341	70 71	R W	CH1 automatic range-shift 4th range upper limit	-30000 to 99999 -32768: No setting (Decimal point position of recording range is used.) Error code: 01H, 02H, 03H, 12H
50342	70 71	R W	CH1 automatic range-shift 5th range upper limit	-30000 to 99999 -32768: No setting (Decimal point position of recording range is used.) Error code: 01H, 02H, 03H, 12H
50348	70 71	R W	CH1 input adjustment factor a	-9.99999 to 9.99999 Error code: 01H, 02H, 03H, 12H
50349	70 71	R W	CH1 input adjustment factor b	-9.99999 to 9.99999 Error code: 01H, 02H, 03H, 12H
50351 to 50399	70 71	R W	CH2 floating point Setting parameter	Same as CH1 parameters (50301 to 50349) Reference No.: CH1 reference No. + 50
50401 to 50449	70 71	R W	CH3 floating point Setting parameter	Same as CH1 parameters (50301 to 50349) Reference No.: CH1 reference No. + 100
50451 to 50499	70 71	R W	CH4 floating point Setting parameter	Same as CH1 parameters (50301 to 50349) Reference No.: CH1 reference No. + 150
50501 to 50549	70 71	R W	CH5 floating point Setting parameter	Same as CH1 parameters (50301 to 50349) Reference No.: CH1 reference No. + 200
50551 to 50599	70 71	R W	CH6 floating point Setting parameter	Same as CH1 parameters (50301 to 50349) Reference No.: CH1 reference No. + 250
50601 to 50649	70 71	R W	CH7 floating point Setting parameter	Same as CH1 parameters (50301 to 50349) Reference No.: CH1 reference No. + 300
50651 to 50699	70 71	R W	CH8 floating point Setting parameter	Same as CH1 parameters (50301 to 50349) Reference No.: CH1 reference No. + 350
50701 to 50749	70 71	R W	CH9 floating point Setting parameter	Same as CH1 parameters (50301 to 50349) Reference No.: CH1 reference No. + 400

Reference No.	Applicable function code	R/W	Description	Details
50751 to 50799	70 71	R W	CH10 floating point Setting parameter	Same as CH1 parameters (50301 to 50349) Reference No.: CH1 reference No. + 450
50801 to 50849	70 71	R W	CH11 floating point Setting parameter	Same as CH1 parameters (50301 to 50349) Reference No.: CH1 reference No. + 500
50851 to 50899	70 71	R W	CH12 floating point Setting parameter	Same as CH1 parameters (50301 to 50349) Reference No.: CH1 reference No. + 550
50901 to 50949	70 71	R W	CH13 floating point Setting parameter	Same as CH1 parameters (50301 to 50349) Reference No.: CH1 reference No. + 600
50951 to 50999	70 71	R W	CH14 floating point Setting parameter	Same as CH1 parameters (50301 to 50349) Reference No.: CH1 reference No. + 650
51001 to 51049	70 71	R W	CH15 floating point Setting parameter	Same as CH1 parameters (50301 to 50349) Reference No.: CH1 reference No. + 700
51051 to 51099	70 71	R W	CH16 floating point Setting parameter	Same as CH1 parameters (50301 to 50349) Reference No.: CH1 reference No. + 750
51101 to 51149	70 71	R W	CH17 floating point Setting parameter	Same as CH1 parameters (50301 to 50349) Reference No.: CH1 reference No. + 800
51151 to 51199	70 71	R W	CH18 floating point Setting parameter	Same as CH1 parameters (50301 to 50349) Reference No.: CH1 reference No. + 850
51201 to 51249	70 71	R W	CH19 floating point Setting parameter	Same as CH1 parameters (50301 to 50349) Reference No.: CH1 reference No. + 900
51251 to 51299	70 71	R W	CH20 floating point Setting parameter	Same as CH1 parameters (50301 to 50349) Reference No.: CH1 reference No. + 950
51301 to 51349	70 71	R W	CH21 floating point Setting parameter	Same as CH1 parameters (50301 to 50349) Reference No.: CH1 reference No. + 1000
51351 to 51399	70 71	R W	CH22 floating point Setting parameter	Same as CH1 parameters (50301 to 50349) Reference No.: CH1 reference No. + 1050
51401 to 51449	70 71	R W	CH23 floating point Setting parameter	Same as CH1 parameters (50301 to 50349) Reference No.: CH1 reference No. + 1100
51451 to 51499	70 71	R W	CH24 floating point Setting parameter	Same as CH1 parameters (50301 to 50349) Reference No.: CH1 reference No. + 1150

## 8-10. Range No. Reference Table

Input type		Range No.	Measuring range		
DC voltage		01	-13.80	to	13.80 mV
		02	-27.60	to	27.60 mV
		03	-69.00	to	69.00 mV
		04	-200.0	to	200.0 mV
		05	-500.0	to	500.0 mV
		16	-1.00	to	1.00 V
		07	-5.00	to	5.00 V
		08	-10.00	to	10.00 V
		09	-20.00	to	20.00 V
		10	-50.00	to	50.00 V
Thermocouple	K	21	to200.0	to	300.0 °C
		22	to200.0	to	600.0 °C
		23	to200	to	1370 °C
	E	24	to200.0	to	200.0 °C
		25	to200.0	to	350.0 °C
		26	to200	to	900 °C
	J	27	to200.0	to	250.0 °C
		28	to200.0	to	500.0 °C
		29	to200	to	1200 °C
	T	30	to200.0	to	250.0 °C
		31	to200.0	to	400.0 °C
	R	32	0	to	1200 °C
		33	0	to	1760 °C
	S	34	0	to	1300 °C
		35	0	to	1760 °C
	B	36	0	to	1820 °C
		37	to200.0	to	400.0 °C
	N	38	to200.0	to	750.0 °C
		39	to200	to	1300 °C
		51	to200.0	to	250.0 °C
	U	52	to200.0	to	500.0 °C
		53	to200.0	to	600.0 °C
		54	to200.0	to	250.0 °C
	L	55	to200.0	to	500.0 °C
		56	to200	to	900 °C
		40	0	to	2315 °C
	W-WRe26	41	0	to	2315 °C
	WRe5-WRe26	44	0.0	to	290.0 °C
		45	0.0	to	600.0 °C
	NiMo-Ni	46	0	to	1310 °C
48		0.0	to	350.0 °C	
Platinel 2	49	0.0	to	650.0 °C	
	50	0	to	1390 °C	
	43	0	to	1880 °C	
PtRh40-PtRh20	47	0.0	to	280.0 K	
CR-AuFe	94	0.0	to	1000.0 °C	
Resistance thermometer	Pt100	70	to140.0	to	150.0 °C
		71	to200.0	to	300.0 °C
		84	to200.0	to	649.0 °C
		72	to200.0	to	850.0 °C
	Old Pt100	73	to140.0	to	150.0 °C
		74	to200.0	to	300.0 °C
		75	to200.0	to	649.0 °C
	JPt100	76	to140.0	to	150.0 °C
		77	to200.0	to	300.0 °C
		78	to200.0	to	649.0 °C
	Pt50	79	to200.0	to	649.0 °C
	Pt-Co	80	4.0	to	374.0 K

---

## 9. PRIVATE Protocol

---

This protocol provides measured data transmission function only.



### Caution

Make sure to read and understand this section to avoid any troubles.

#### 1. Requesting data immediately after power-on generates an error

The unit is always ready for communications and responsive to data request from PC. However, after power-on, the unit does not respond normally until channel data becomes ready.

For example, it takes about 20 seconds for a 24-point recorder to have the data ready. When a data request is received during this period, the unit returns an error No. 9 (busy).

#### 2. Keys restricted in parameter setting (writing)

When operating the unit from PC to set parameters, etc., the  key becomes temporarily unavailable while a setting window is displayed. The key will be available again by changing the window displayed.

#### 3. RS232C requires communication address

##### (For the case of PRIVATE2 communication protocol with connection sequence)

Although PC and the unit are connected one-to-one in RS232C communication, a communication address needs to be set to establish communication.

#### 4. Be careful about command re-transmission as no control signal line is used

The serial interface of the unit makes communication without using a control line. Therefore, attention should be paid when re-transmitting a command since reception failure may occur depending on the unit condition.

#### 5. Do not disconnect communication cable or device, or turn ON/OFF the power during communication

Disconnecting the cables or devices constituting the serial interface, or turning ON/OFF the devices during communication may stop operation or generate an error. If this happens, all the devices constituting the serial interface need to be reset to start the operation from the beginning.

#### 6. Make sure that communication driver has been turned OFF before sending next command

For RS422A/485 communication, multiple devices are connected in the same communication line, but only one device whose address is specified by PC passes through the communication line. To send all characters safely to PC, the communication line driver is turned OFF a few moments (about 5ms) after sending the last character. If a PC sends a command to the next device before the driver is turned OFF, signals will interfere with each other resulting in communication failure.

## 9-1. Basic Communication Sequence

As a basic sequence, PC sends a command of data request or parameter setting to this unit and then this unit responds to it.

## 9-2. Control Character Code

The following control character codes are used in the communication format.

Character	Meaning	Hexadecimal data
ENQ	Inquiry	05H
ACK	Positive response	06H
NAK	Negative response	15H
EOT	Abandon data link	04H
STX	Text start	02H
ETX	Text end	03H
CR	Return	0DH
LF	Line feed	0AH

## 9-3. Data Link

In RS422A/485 communication, multiple devices can be connected in parallel, therefore, one device of communication target needs to be specified (establish a data link). In RS232C communication, on the other hand, this unit is connected one-to-one with PC without the need of establishing a data link. In this case, communication is performed according to "9-4. Data Transmission and Reception" with PRIVATE 1 protocol (without connection sequence).

### 1. Establishing data link

According to the following procedure, only a device having the specified communication address is allowed to communicate with PC.

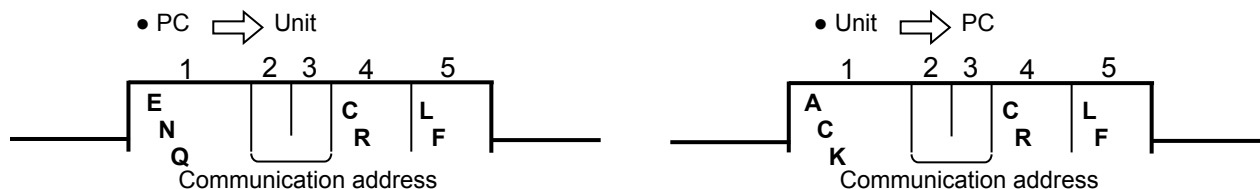

- (1) No response is made from this units without the specified communication address.
- (2) Once a data link has been established, communication takes place according to "9-4. Data Transmission and Reception".

### 2. Abandoning data link

- (1) Data link is abandoned when it is established for another unit.  
(When another communication address is recognized with **ENQ**.)
- (2) Data link is abandoned when **EOT** is received.

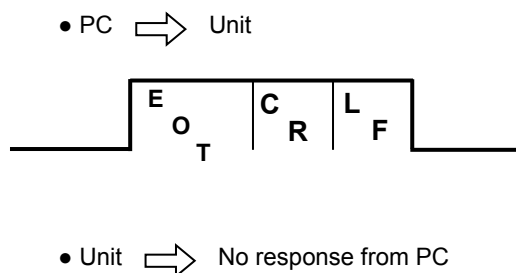



## 9-4. Data Transmission and Reception

### 1. Commands

The following commands are available on this units to allow various data requests.

Note that the four commands "LR", "HR", "LO" and "HO" are used exclusively for 24-point recorders. Do not use these commands for units other than the 24-point recorders.

- (1) For the case of 24-point recorders, the receive buffer may overflow due to the number of transmitted characters exceeding 256.  
In this case, request data for 1 to 12CH and 13 to 24CH separately using the dedicated commands for 24-point recorders "LR/LO (1 to 12CH)" and "HR/HO (13 to 24CH)".
- (2) Note that using these commands on units other than the 24-point recorders causes a format error.

Command	Function	Description
DR ( LR (1 - 12CH) HR (13 - 24CH) )	Request data only once	Immediately transmit the latest data and complete the command.
DO ( LO (1 - 12CH) HO (13 - 24CH) )	Request data only once	Immediately transmit the latest data and complete the command.
ST	Request data every 5 seconds	(1) Transmit the characters "SCB" when data is requested during input scanning. The data is transmitted after the scanning is completed. After that, data is transmitted every time scanning is completed.
		(2) Transmit the latest data in hand immediately when data is requested while input scanning is not in progress. After that, data is transmitted every time scanning is completed.
DS	End data transmission upon input scanning	End data transmission executed by ST command every five seconds.

### 2. Command format

• PC ⇒ Unit

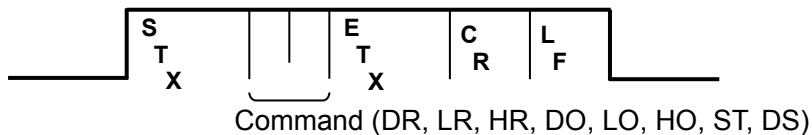

### 3. Response to commands

(1) Unit → PC

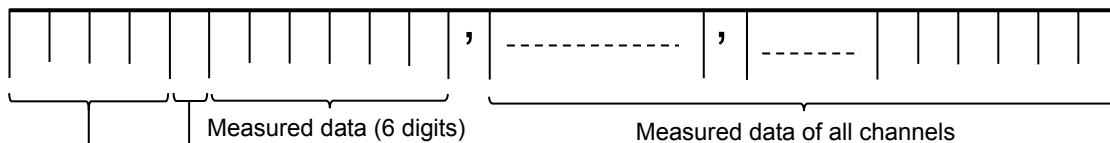
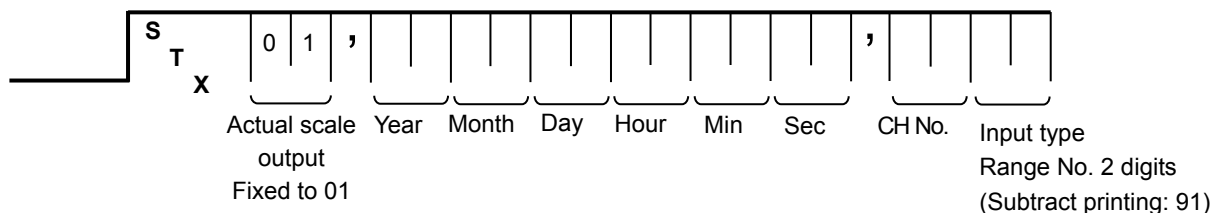

Status  
 0: Normal  
 1: Over range  
 2: Under range  
 3: Burnout  
 (Upper or lower limit)

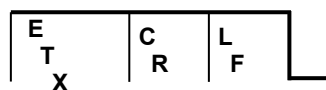

Alarm status  
 1 2 3 4  
 0: Not activated  
 1: Upper alarm  
 2: Lower alarm  
 3: Differential upper alarm  
 4: Differential lower alarm  
 5: Rate-of-change upper alarm  
 6: Rate-of-change lower alarm



#### Caution

- (1) A comma “,” serves as a delimiter for the type, date and measured data.
- (2) In case of over range, under range or burnout (upper/lower limit), the measured data shows “999999”.
- (3) The above example shows a format without checksum. See “9-5. Checksum” when using checksum.

(2) Scan busy output

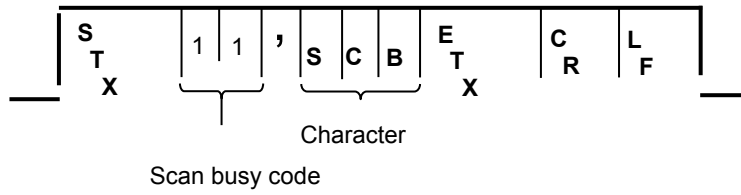

(3) Normal response (Response upon DS command receipt)

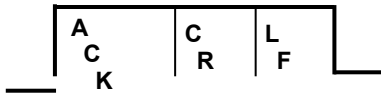

(4) Abnormal response

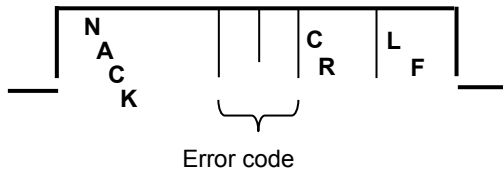

- 01: Framing error
- 02: Overrun error
- 03: Parity error
- 04: Checksum error (when checksum is used)
- 06: ETX time out
- 09: Device busy
- 10: Format error

## 9-5. Checksum

Checksum data can be added to check for transmission errors.

When checksum is used, a total sum of characters after STX up to ETX is calculated and the low-order eight bits are divided into high-order four bits and low-order four bits. They are then converted to characters 0 to F, and transmitted or received with low-order bits followed by high-order bits. Checksum is added to both transmitted and received data for checking.

When transmitted or received data is altered by noise or other factors, it can be detected by comparing with the checksum data at the receiver side.

[What is checksum data?]

Checksum data is a 2-digit hexadecimal value expressing the low-order eight bits of total sum of text data converted to binary numbers (STX excluded, but comma “,” and ETX included).

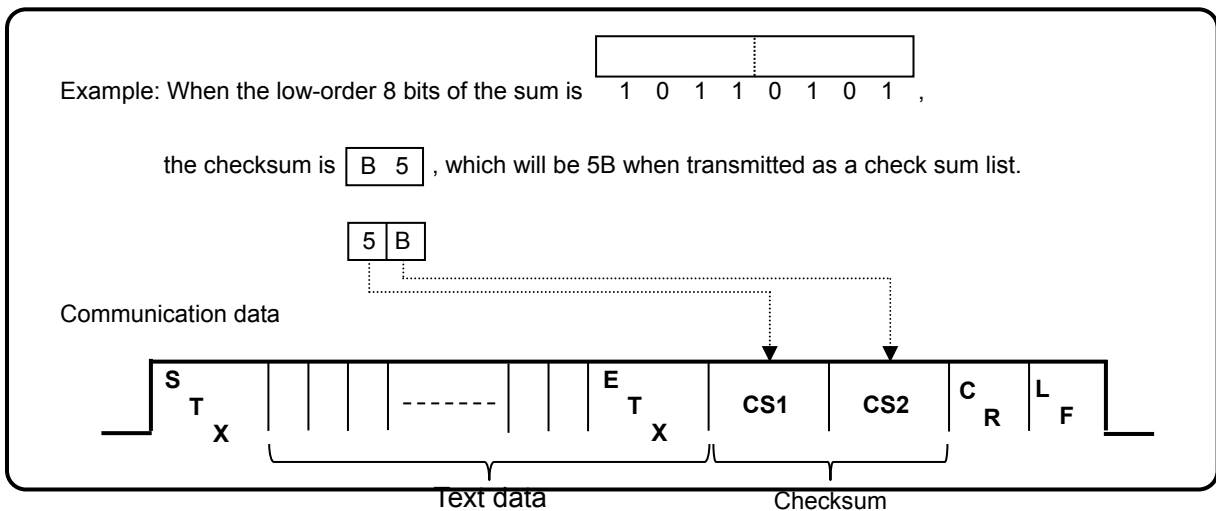

Example: For the case of DO

Data	Code
D	44H
O	4FH
ETX	03H
<hr/>	
Total	96H → CS1 = 36H (6), CS2 = 39H (9)

(Reference)

DR:99H	→ CS1 = 39H (9), CS2 = 39H (9)
LR:A1H	→ CS1 = 31H (1), CS2 = 41H (A)
HR:9DH	→ CS1 = 44H (D), CS2 = 39H (9)
DO:96H	→ CS1 = 36H (6), CS2 = 39H (9)
LO:9EH	→ CS1 = 45H (E), CS2 = 39H (9)
HO:9AH	→ CS1 = 41H (A), CS2 = 39H (9)
ST:AAH	→ CS1 = 41H (A), CS2 = 41H (A)
DS:9AH	→ CS1 = 41H (A), CS2 = 39H (9)

---

# 10. Web Settings/Display

---

You can set items related to input or recording of the unit, or display data via web browser.

## 10-1. Top Page

When the IP address of the unit is accessed via web browser, the following window will be displayed after password authentication.

The user name required for password authentication is fixed to "HR\_USER" which cannot be changed, but a password can be set or changed to an arbitrary character string on the unit (see section 6-1).

The window consists of two frames containing a menu in the left and a list of settings of the selected items from the menu in the right.

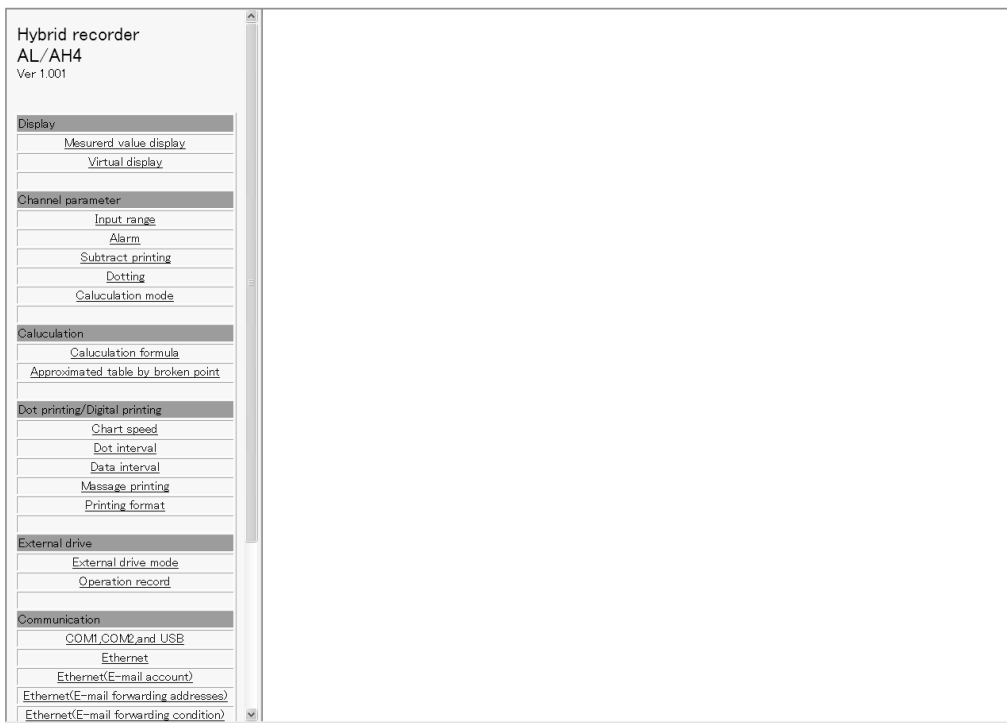

## 10-2. Display

### 1. Displaying measured value

Current measured values (for pen type measured value and bar graph) and statuses of alarm level 1 to 4 of all channels are shown in the right frame.

#### For multi-point type

Hybrid recorder AL/AH4 Ver 1.001																							
Display																							
Measured value display																							
Virtual display																							
Channel parameter																							
Input range																							
Alarm																							
Subtract printing																							
Dotting																							
Calculation mode																							
Calculation																							
Display measuring data																							
Rec: OFF SD: ---																							
CH1 79.7K				CH2 1.28°C				CH3 7.20V				CH4 485°C				CH5 31.8°C				CH6 0°C			
CH7 1000°C				CH8 143°C				CH9 146°C				CH10 127°C				CH11 2.19°C				CH12 2.19°C			
CH13 1000°C				CH14 1000°C				CH15 1000°C				CH16 173°C				CH17 173°C				CH18 171°C			
CH19 1.43°C				CH20 174°C				CH21 170°C				CH22 174°C				CH23 146°C				CH24 318°C			

#### For pen-type

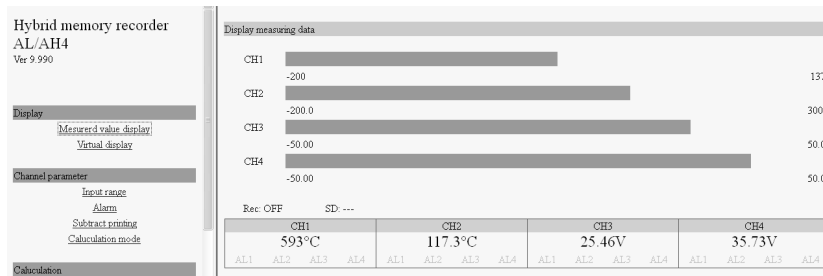

### 2. Displaying virtual window

When you select (click) “Virtual display” in the left frame, a password for virtual window authentication will be required in the right frame. The password is fixed to “3571”. After entering the password, click the “Authenticate” button.

The virtual window shows the same contents as those on the unit display. The buttons shown in the lower part of the window can be operated in the same manner as those on the unit. Since image file is used to create a virtual window, it requires more time to read compared to other windows.

To prevent erroneous operation, avoid operating on the virtual window and the unit at the same time. Do not use the browser buttons such as “Refresh”, “Back” and “Forward”. Use the buttons shown in the lower part of the window to operate the unit.

Hybrid recorder AL/AH4 Ver 1.001																							
Display																							
Measured value display																							
Virtual display																							
Channel parameter																							
Input range																							
Alarm																							
Subtract printing																							
Dotting																							
Calculation mode																							
Calculation																							
Calculation formula																							
Approximated table by broken point																							
Dot printing/Digital printing																							
Chart speed																							
Dot interval																							
Data interval																							
Message printing																							
Printing format																							
External drive																							
External drive mode																							
Operation record																							
Communication																							
COM1, COM2, and USB																							
Ethernet																							
Ethernet(E-mail account)																							
Ethernet(E-mail forwarding addresses)																							
Ethernet(E-mail forwarding condition)																							
<div style="text-align: right;">2011/07/04 11:07:41 51mm/H</div> <div style="text-align: center; font-size: 2em;">01 300.4<sub>K</sub></div> <div style="text-align: center; font-size: 0.8em;">SD --- (ENT) CH SET (MENU) MENU (FNC1) AUTO/CONST (FNC2) ALARM</div> <div style="text-align: center; margin-top: 20px;"> <span>REC</span> <span>DATAP</span> <span>MENU</span> <span>ESD</span> <span>←</span> <span>↑</span> <span>→</span>  <span>FEED</span> <span>FUNC1</span> <span>FUNC2</span> <span>ENTER</span> <span>↓</span> </div>																							

## 10-3. Parameters Set by Each CH

### 1. Range

Set or change input parameters. Setting contents are displayed on a channel to channel basis. You cannot set or change these parameters during recording.

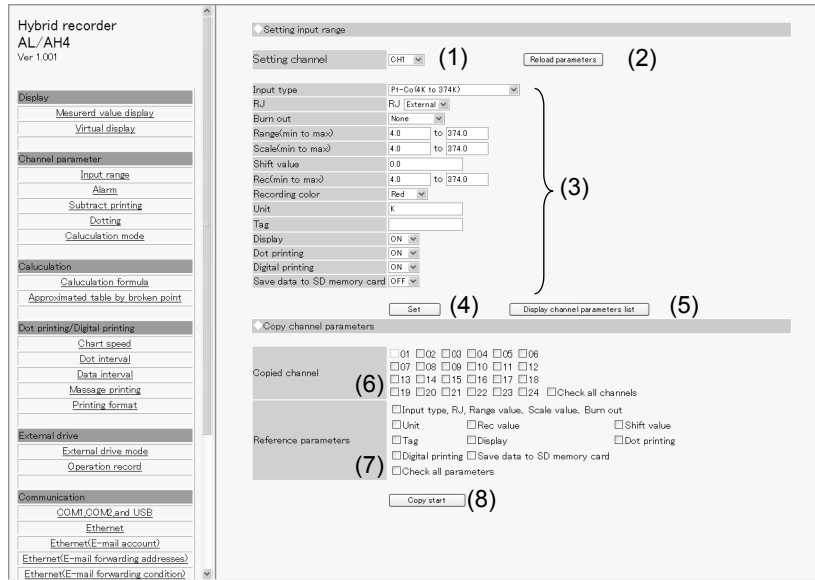

- (1) Select a channel to be set.  
When the channel is changed to another, the display contents will be updated to those currently set on the unit.
- (2) Clicking the [Reload parameters] button updates the display contents to those currently set on the unit.
- (3) Select or enter a value for each parameter. For details of the settings, refer to "Input Type Settings" in the instruction manual for "General" provided separately.
- (4) When the [Set] button is clicked, the display contents will be set onto the unit.  
When an error is found in the settings, the following message will appear in the right frame.

**Setting parameters failed**  
Go back to the page, and set once more after identify input value.  
Push button showed "Reload parameters" when you want to identify set parameters.

- (5) When the [Display channel parameters list] button is clicked, another window containing the list of registered input parameter settings of all channels will open.
- (6) To copy an input parameter setting of the setting channel, select a destination channel.
- (7) Select parameters to be copied.
- (8) Click the [Copy start] button to start copying settings.  
When the copy fails, the following message will appear in the right frame.

**Setting parameters failed**  
Go back to the page, and set once more after identify input value.  
Push button showed "Reload parameters" when you want to identify set parameters.

When setting  $\mu$ ,  $\Omega$ , square, and cube for message, inputting based on following table. Converted character is set in the instrument.

Instrument display		Browser input
$\mu$	← →	$\mu$
$\Omega$	← →	OHM
2	← →	2
3	← →	3

\*  $\Omega$  is treated as 3 characters on browser display.

## 2. Alarm

Set or change alarm parameters. Setting contents of level 1 to 4 are displayed on a channel to channel basis.

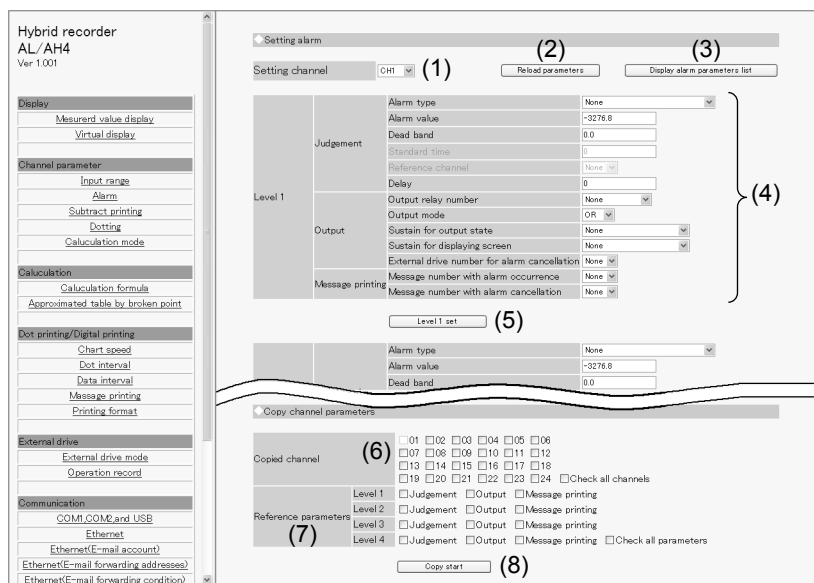

- (1) Select a channel to be set.  
When the channel is changed to another, the display contents will be updated to those currently set on the unit.
- (2) Clicking the [Reload parameters] button updates the display contents to those currently set on the unit.
- (3) When the [Display alarm parameters list] button is clicked, another window containing the list of registered alarm settings of all channels and levels will open.
- (4) Select or enter a value for each parameter. For details of the settings, refer to “Alarm Settings” in the instruction manual for “General” provided separately.
- (5) When the [Level 1 (to 4)] set] button is clicked, the display contents will be set onto the unit.  
When an error is found in the settings, the following message will appear in the right frame.

Setting parameters failed  
Go back to the page, and set once more after identify input value.  
Push button showed "Reload parameters" when you want to identify set parameters.

- (6) To copy an alarm parameter setting of the setting channel, select a destination channel.
- (7) Select items to be copied from “Judgment”, “Output” and “Message printing”. Parameters to be copied depend on the alarm setting of destination channel.
- (8) Click the [Copy start] button to start copying settings.  
When the copy fails, the following message will appear in the right frame.

Setting parameters failed  
Go back to the page, and set once more after identify input value.  
Push button showed "Reload parameters" when you want to identify set parameters.



### 3. Subtract printing

Set or change subtract printing parameters. Setting contents are displayed on a channel to channel basis.

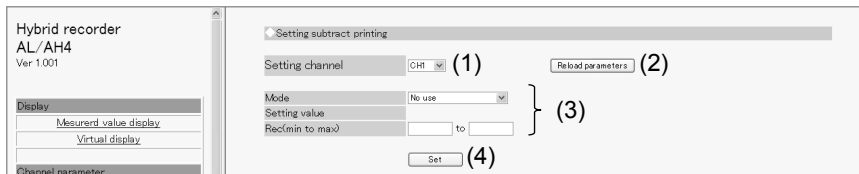

- (1) Select a channel to be set.  
When the channel is changed to another, the display contents will be updated to those currently set on the unit.
- (2) Clicking the [Reload parameters] button updates the display contents to those currently set on the unit.
- (3) Select or enter a value for each parameter. For details of the settings, refer to “Subtract Printing Settings” in the instruction manual for “General” provided separately.
- (4) When the [Set] button is clicked, the display contents will be set onto the unit.  
When an error is found in the settings, the following message will appear in the right frame.

**Setting parameters failed**  
Go back to the page, and set once more after identify input value.  
Push button showed "Reload parameters" when you want to identify set parameters.

### 4. Trace printing (dot printing) ON/OFF

Set or change the trace printing (dot printing) ON/OFF status and the color for each channel.  
A list of setting contents of all channels is displayed.

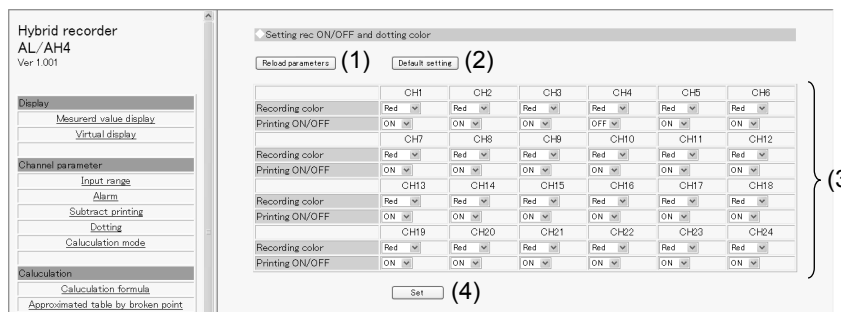

- (1) Clicking the [Reload parameters] button updates the display contents to those currently set on the unit.
- (2) Clicking the [Default setting] button changes the recording color of each channel to the default (only the display changes at this point). For the default colors, refer to “List of Factory Default Settings” in the instruction manual for “General” provided separately.
- (3) Select a value for each parameter.
- (4) When the [Set] button is clicked, the display contents will be set onto the unit.  
When an error is found in the settings, the following message will appear in the right frame.

**Setting parameters failed**  
Go back to the page, and set once more after identify input value.  
Push button showed "Reload parameters" when you want to identify set parameters.

## 5. Calculation

Set or change calculation parameters. Setting contents are displayed on a channel to channel basis.

Calculation parameters vary depending on the calculation type. When the calculation type is changed to another, only the display/input parameters necessary for the selected calculation will be displayed (Calculation type and Decimal points have shared parameters).

Parameters used for each calculation type are shown in the following table.

Calculation type	Parameter					
	1	2	3	4	5	6
Square root Natural logarithm Common logarithm Exponent	Calculation data CH					
Integration	Calculation data CH	Start time	Interval	Unit of integration time	Integration reset method	Integration reset remote contact No.
Max value Min value Average value	Calculation data CH	Start time	Interval			
Temperature and humidity	Dry bulb data CH	Wet bulb data CH				
Data communications input	Communication input data CH					
Arithmetic 1	Calculation data CH X	Calculation data CH Y	Constant A	Constant B	Constant C	Constant D
Arithmetic 2	Calculation data CH X	Calculation data CH Y	Constant A	Constant B		
Formula	Formula No.	Start time	Interval	Unit of calculation time	Calculation reset method	Calculation reset remote contact No.
Broken line approximation	Calculation data CH	Broken line approximation table No.				

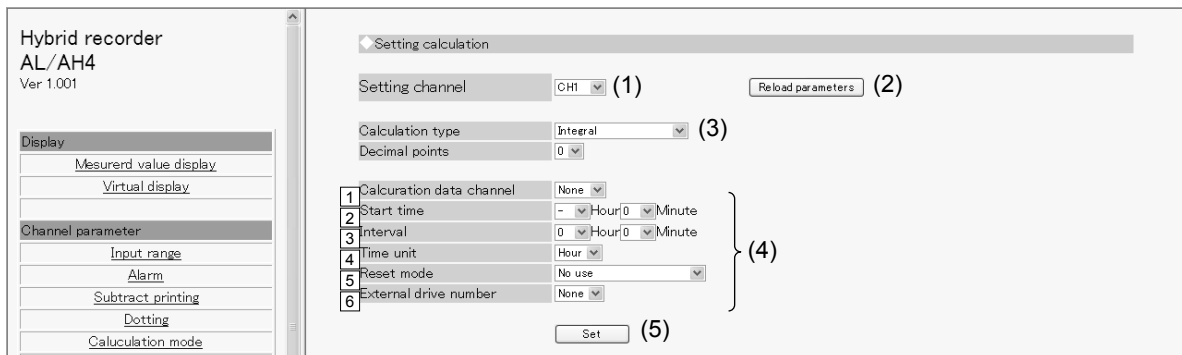

(1) Select a channel to be set.

When the channel is changed to another, the display contents are updated to those currently set on the unit.

(2) Clicking the [Reload parameters] button updates the display contents to those currently set on the unit.

(3) Select a calculation type. Parameters are displayed according to the selected calculation type.

(4) Select or enter a value for each parameter. For details of the settings, refer to "Calculation Settings" in the instruction manual for "General" provided separately.

(5) When the [Set] button is clicked, the display contents will be set onto the unit.

When an error is found in the settings, the following message will appear in the right frame.

Setting parameters failed  
Go back to the page, and set once more after identify input value.  
Push button showed "Reload parameters" when you want to identify set parameters.

## 10-4. Calculation

### 1. Formula

Set or change a formula used for calculation. A list of all formulas is displayed on the window.

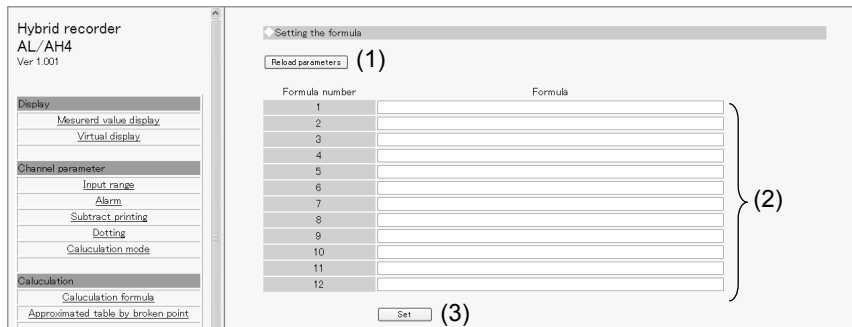

- (1) Clicking the [Reload parameters] button updates the display contents to those currently set on the unit.
- (2) Enter a formula. For details of the settings, refer to “Formula Settings” in the instruction manual for “General” provided separately.
- (3) When the [Set] button is clicked, the display contents will be set onto the unit.  
When an error is found in the settings, the following message will appear in the right frame.

Setting parameters failed  
Go back to the page, and set once more after identify input value.  
Push button showed "Reload parameters" when you want to identify set parameters.



## 10-5. Dotting/Printing

### 1. Chart speed

Set or change the chart speed. When using remote contacts (option), three speeds can be set.

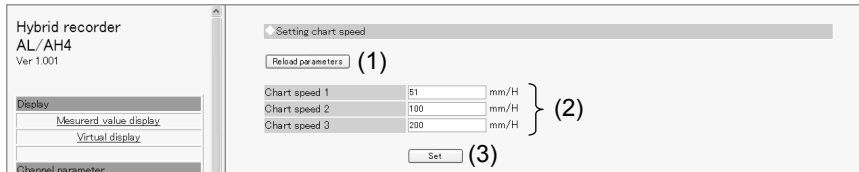

- (1) Clicking the [Reload parameters] button updates the display contents to those currently set on the unit.
- (2) Enter a chart speed. For details of the settings, refer to “Chart Speed Settings” in the instruction manual for “General” provided separately.
- (3) When the [Set] button is clicked, the display contents will be set onto the unit.

When an error is found in the settings, the following message will appear in the right frame.

Setting parameters failed  
Go back to the page, and set once more after identify input value.  
Push button showed "Reload parameters" when you want to identify set parameters.

### 2. Trace printing (dot printing) interval

Set or change the interval of trace printing (dot printing).

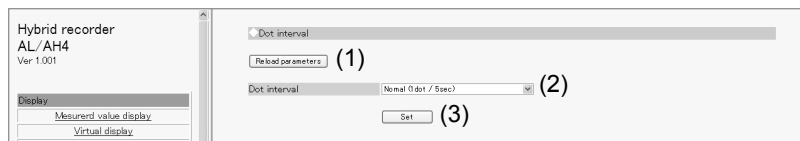

- (1) Clicking the [Reload parameters] button updates the display contents to those currently set on the unit.
- (2) Select a dot printing interval. For details of the settings, refer to “Dot Printing Interval Settings” in the instruction manual for “General” provided separately.
- (3) When the [Set] button is clicked, the display contents will be set onto the unit.

When an error is found in the settings, the following message will appear in the right frame.

Setting parameters failed  
Go back to the page, and set once more after identify input value.  
Push button showed "Reload parameters" when you want to identify set parameters.

### 3. POC (time axis synchronization ON/OFF)

\* pen type only

Set or change the time axis synchronization ON/OFF.

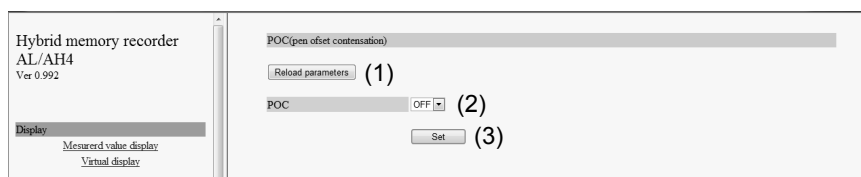

- (1) Clicking the [Reload parameters] button updates the display contents to those currently set on the unit.
- (2) Select time axis synchronization ON/OFF. For details of the settings, refer to “Time Axis Synchronization (POC)” in the instruction manual for “General” provided separately.
- (3) When the [Set] button is clicked, the display contents will be set onto the unit.

When an error is found in the settings, the following message will appear in the right frame.

Setting parameters failed  
Go back to the page, and set once more after identify input value.  
Push button showed "Reload parameters" when you want to identify set parameters.

## 4. Periodic data printing

Set or change parameters used for periodic data printing.

Periodic data printing has the “Interval” and “Designate time” modes. The two modes are switched between them according to the parameter settings.

When the Interval is set to other than “0” Hour “0” Minute, “Interval printing” will be performed (preferred).

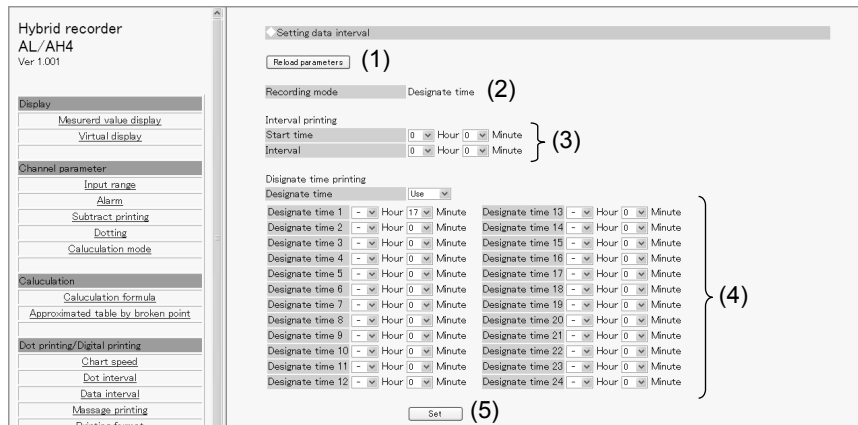

- (1) Clicking the [Reload parameters] button updates the display contents to those currently set on the unit.
- (2) The recording mode is displayed depending on the setting contents. The mode is any one of the followings: “None”, “Interval” and “Designate time”. The conditions of each mode are shown in the following table.

Recording mode	Interval printing setting	Designate time printing setting
None	0 Hour 0 Minute	Unused
Interval	Other than 0 Hour 0 Minute	Setting ignored
Designate time	0 Hour 0 Minute	Used

- (3) Select values for interval printing parameters.  
For details of the settings, refer to “Periodic (Data Interval) Data Printing Settings” in the instruction manual for “General” provided separately.
- (4) Select values for designate time printing parameters.  
For details of the settings, refer to “Periodic (Specified time) Data Printing Settings” in the instruction manual for “General” provided separately.
- (5) When the [Set] button is clicked, the display contents will be set onto the unit.  
When an error is found in the settings, the following message will appear in the right frame.

Setting parameters failed  
Go back to the page, and set once more after identify input value.  
Push button showed "Reload parameters" when you want to identify set parameters.

## 5. Message printing

Set or change parameters used for message printing. A list of all messages is displayed on the window.

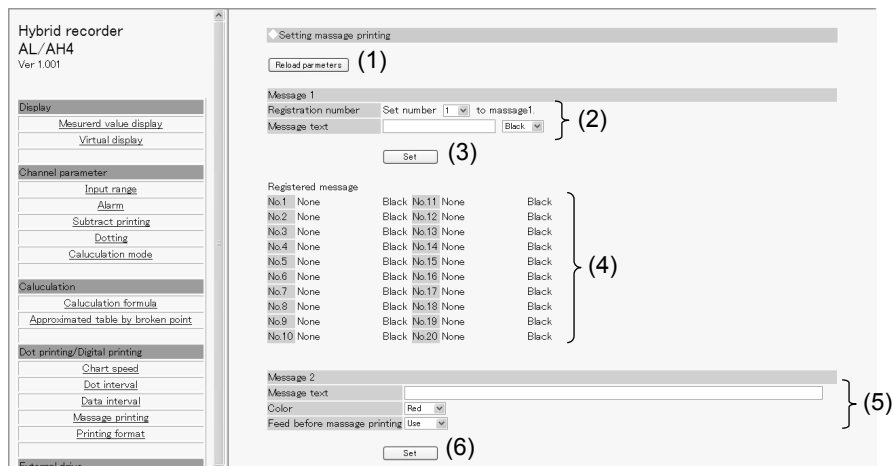

- (1) Clicking the [Reload parameters] button updates the display contents to those currently set on the unit.
- (2) Select a message number of Message 1, and select or enter a value for each parameter.  
For details of the settings, refer to “Message Printing 1 Settings” in the instruction manual for “General” provided separately.
- (3) When the [Set] button is clicked, the display contents of Message 1 will be set onto the unit.  
When an error is found in the settings, the following message will appear in the right frame.

Setting parameters failed  
Go back to the page, and set once more after identify input value.  
Push button showed "Reload parameters" when you want to identify set parameters.

- (4) A list of registered messages of Message 1 (No. 1 to 20) is displayed.
- (5) Select or enter a value for each Message 2 parameter.  
For details of the settings, refer to “Message Printing 2 Settings” in the instruction manual for “General” provided separately.
- (6) When the [Set] button is clicked, the display contents of Message 2 will be set onto the unit.  
When an error is found in the settings, the above message will appear as described in step (3).

When setting  $\mu$ ,  $\Omega$ , square, and cube for message, inputting based on following table. Converted character is set in the instrument.

Instrument display		Browser input
$\mu$	← →	$\mu$
$\Omega$	← →	OHM
2	← →	2
3	← →	3

\*  $\Omega$  is treated as 3 characters on browser display.



## 6. Recording format

Set or change the recording format. The recording format is selected from the standard, auto range normal, compressed/expanded printing (Spread), zone printing (Parallel) and auto range overlap.

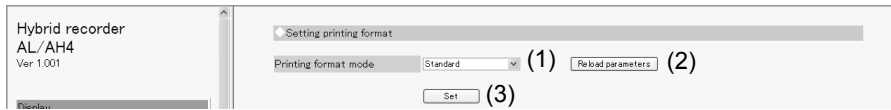

- (1) Select a recording format. When the recording format is changed to another, the parameters of the selected format will be displayed (parameters are not displayed when “Standard” is selected).  
For details of the settings, refer to “Recording Format Settings” in the instruction manual for “General” provided separately.

- (2) Clicking the [Reload parameters] button updates the display contents to those currently set on the unit.
- (3) When the [Set] button is clicked, the display contents will be set onto the unit.

When an error is found in the settings, the following message will appear in the right frame.

**Setting parameters failed**  
Go back to the page, and set once more after identify input value.  
Push button showed "Reload parameters" when you want to identify set parameters.

- 1) Automatic range (normal)

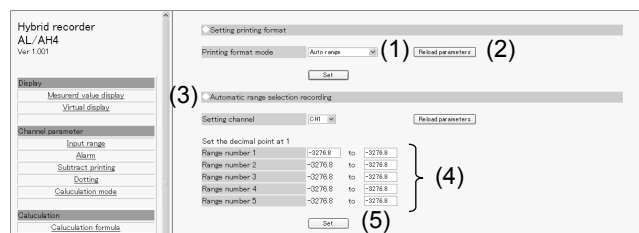

- (1) Select a channel to be set.  
When the channel is changed to another, the display contents are updated to those currently set on the unit.
- (2) Clicking the [Reload parameters] button updates the display contents to those currently set on the unit.
- (3) The decimal point position used for the scale of the setting channel is displayed. The values in the following parameters need to have the displayed number of decimals.

- (4) Enter a value to each parameter.

When a parameter is left blank or set to “-32768 (with no concern for decimal point position)”, the subsequent ranges will be invalid (when set internally, enter “-32768”).

For details of the settings, refer to “Auto Range Settings” in the instruction manual for “General” provided separately.

- (5) When the [Set] button is clicked, the display contents will be set onto the unit.

When an error is found in the settings, the following message will appear in the right frame.

**Setting parameters failed**  
Go back to the page, and set once more after identify input value.  
Push button showed "Reload parameters" when you want to identify set parameters.

## 2) Compressed/expanded printing

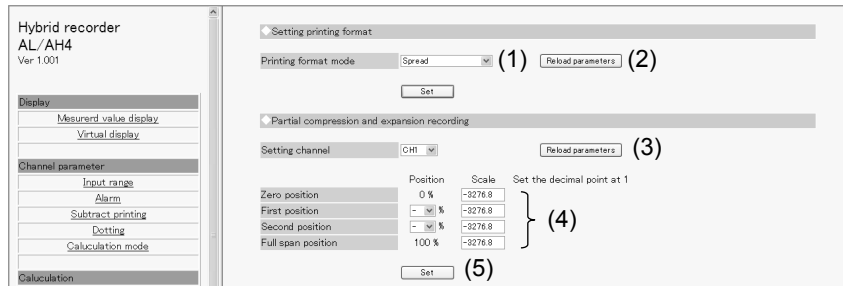

- (1) Select a channel to be set.  
When the channel is changed to another, the display contents are updated to those currently set on the unit.
- (2) Clicking the [Reload parameters] button updates the display contents to those currently set on the unit.
- (3) The decimal point position used for the scale of the setting channel is displayed. The values in the following parameters need to have the displayed number of decimals.
- (4) Enter a value to each parameter.  
When "0 %" is selected for a position (break point), the subsequent positions (break points) will be invalid. Also, when a recording scale is left blank or set to "-32768 (with no concern for decimal point position)", the subsequent positions (break points) will be invalid (when set internally, enter "-32768").  
For details of the settings, refer to "Compressed/Expanded Printing Settings" in the instruction manual for "General" provided separately.
- (5) When the [Set] button is clicked, the display contents will be set onto the unit.  
When an error is found in the settings, the following message will appear in the right frame.

Setting parameters failed

Go back to the page, and set once more after identify input value.

Push button showed "Reload parameters" when you want to identify set parameters.

## 3) Zone printing

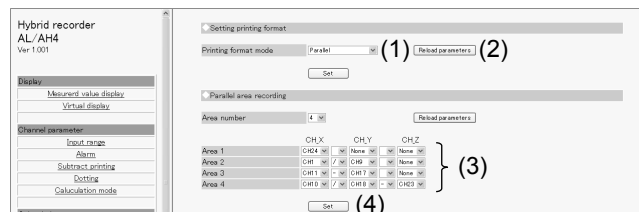

- (1) Select a number of divisions of the area. When this is changed, the display contents are updated to those currently set on the unit. The specified number of areas will be displayed (set).
- (2) Clicking the [Reload parameters] button updates the display contents to those currently set on the unit.
- (3) Select a value for each parameter.  
Delimiters used between CH\_X and CH\_Y, and between CH\_Y and CH\_Z are selected from "blank", "·" and "-".  
For details of the settings, refer to "Zone Printing Settings" in the instruction manual for "General" provided separately.
- (4) When the [Set] button is clicked, the display contents will be set onto the unit.  
When an error is found in the settings, the following message will appear in the right frame.

Setting parameters failed

Go back to the page, and set once more after identify input value.

Push button showed "Reload parameters" when you want to identify set parameters.

#### 4) Automatic range-shift (overlap)

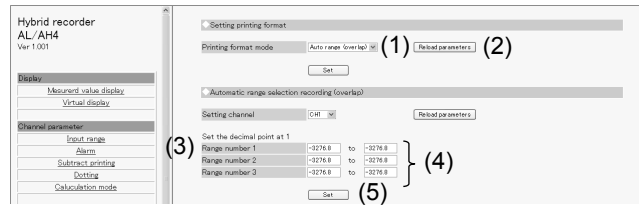

- (1) Select a channel to be set.  
When the channel is changed to another, the display contents are updated to those currently set on the unit.
- (2) Clicking the [Reload parameters] button updates the display contents to those currently set on the unit.
- (3) The decimal point position used for the scale of the setting channel is displayed. The values in the following parameters need to have the displayed number of decimals.
- (4) Enter a value to each parameter.  
When a parameter is left blank or set to “-32768 (with no concern for decimal point position)”, the subsequent ranges will be invalid (when set internally, enter “-32768”).  
For details of the settings, refer to “Auto Range Settings” in the instruction manual for “General” provided separately.
- (5) When the [Set] button is clicked, the display contents will be set onto the unit.  
When an error is found in the settings, the following message will appear in the right frame.

Setting parameters failed  
Go back to the page, and set once more after identify input value.  
Push button showed "Reload parameters" when you want to identify set parameters.

## 10-6. Remote Contacts (Option)

### 1. Remote contact function

Set or change the assignment of remote contact functions.

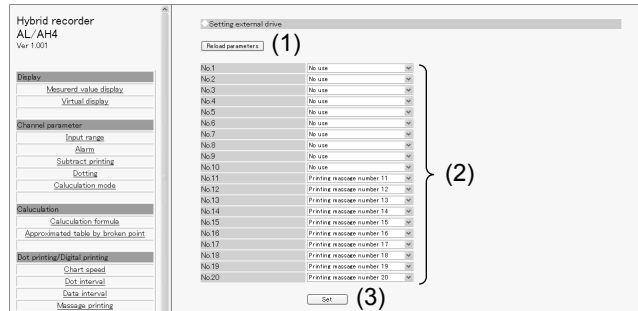

- (1) Clicking the [Reload parameters] button updates the display contents to those currently set on the unit.
- (2) Select a function allocated to each remote contact number. Selectable functions depend on the remote contact number. Also, some functions require allocation to multiple remote contact numbers.  
For details of the settings, refer to “External Operation Settings” in the instruction manual for “General” provided separately.
- (3) When the [Set] button is clicked, the display contents will be set onto the unit.  
When an error is found in the settings, the following message will appear in the right frame.

#### Setting parameters failed

Go back to the page, and set once more after identify input value.  
Push button showed "Reload parameters" when you want to identify set parameters.

## 2. Operation recording

Set or change the operation recording parameters.

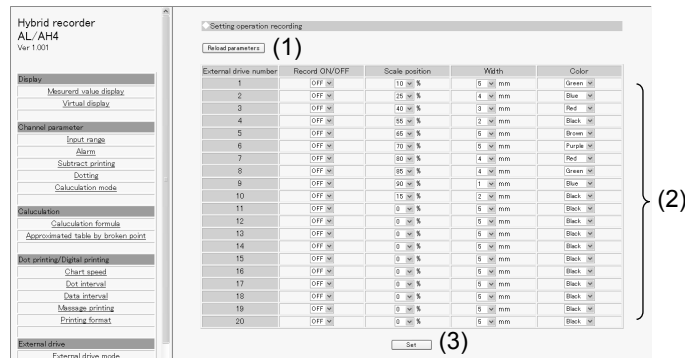

- (1) Clicking the [Reload parameters] button updates the display contents to those currently set on the unit.
- (2) Select a value for each parameter. For details of the settings, refer to “Operation Recording Settings” in the instruction manual for “General” provided separately.
- (3) When the [Set] button is clicked, the display contents will be set onto the unit.

When an error is found in the settings, the following message will appear in the right frame.

**Setting parameters failed**  
 Go back to the page, and set once more after identify input value.  
 Push button showed "Reload parameters" when you want to identify set parameters.

## 10-7. Communication

### 1. COM1, COM2 and USB settings

Set or change communication parameters (COM1, COM2 and USB).

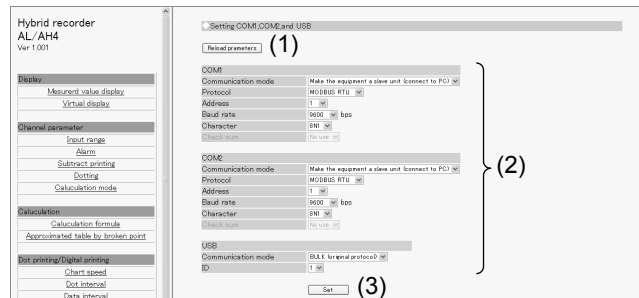

- (1) Clicking the [Reload parameters] button updates the display contents to those currently set on the unit.
- (2) Select a value for each parameter. For details of the COM1 and COM2 settings and USB settings, refer to “COM Port Settings” and “USB Engineering Port Settings” respectively in the instruction manual for “General” provided separately.
- (3) When the [Set] button is clicked, the display contents will be set onto the unit.  
When an error is found in the settings, the following message will appear in the right frame.

Setting parameters failed

Go back to the page, and set once more after identify input value.  
Push button showed "Reload parameters" when you want to identify set parameters.

## 2. Ethernet settings

Set or change communication (Ethernet) parameters. The setting contents become effective about 15 seconds after completing the settings.

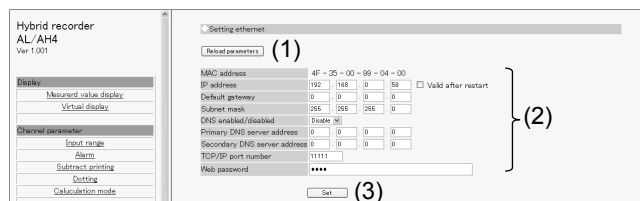

- (1) Clicking the [Reload parameters] button updates the display contents to those currently set on the unit.
- (2) Select or enter a value for each parameter. For details of the settings, refer to “IP Address etc... Settings” in the instruction manual for “General” provided separately.
- (3) When the [Set] button is clicked, the display contents will be set onto the unit.

When an error is found in the settings, the following message will appear in the right frame.

**Setting parameters failed**  
Go back to the page, and set once more after identify input value.  
Push button showed "Reload parameters" when you want to identify set parameters.

### 3. Ethernet (E-mail account)

Set or change Ethernet (E-mail account) parameters.

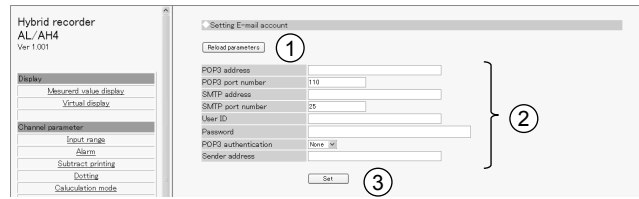

- (1) Clicking the [Reload parameters] button updates the display contents to those currently set on the unit.
- (2) Select or enter a value for each parameter. For details of the settings, refer to “E-mail Settings” in the instruction manual for “General” provided separately.
- (3) When the [Set] button is clicked, the display contents will be set onto the unit.

When an error is found in the settings, the following message will appear in the right frame.

Setting parameters failed  
Go back to the page, and set once more after identify input value.  
Push button showed "Reload parameters" when you want to identify set parameters.

### 4. Ethernet (destination E-mail address)

Set or change Ethernet (destination E-mail address) parameters.

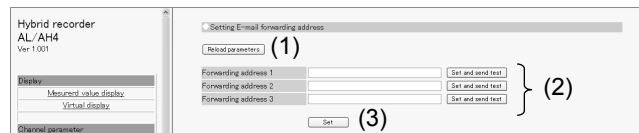

- (1) Clicking the [Reload parameters] button updates the display contents to those currently set on the unit.
- (2) Enter a destination E-mail addresses. E-mail can be sent to up to three different addresses. For details of the settings, refer to “E-mail Settings” in the instruction manual for “General” provided separately. Click the [Set and send test] button located on the right side of the address field to perform individual setting and transmission test.
- (3) When the [Set] button is clicked, the display contents will be set onto the unit.

When an error is found in the settings, the following message will appear in the right frame.

Setting parameters failed  
Go back to the page, and set once more after identify input value.  
Push button showed "Reload parameters" when you want to identify set parameters.



## 5. Ethernet (E-mail transmission condition)

Set or change Ethernet (E-mail transmission condition) parameters.

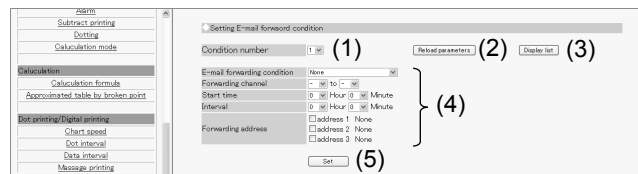

- (1) Select a transmission condition number. Up to six conditions can be set.
- (2) Clicking the [Reload parameters] button updates the display contents to those currently set on the unit.
- (3) When the [Display list] button is clicked, another window containing the list of registered transmission conditions 1 to 6 will open.
- (4) Select a value for each parameter. For details of the settings, refer to “E-mail Settings” in the instruction manual for “General” provided separately.
- (5) When the [Set] button is clicked, the display contents will be set onto the unit.

When an error is found in the settings, the following message will appear in the right frame.

**Setting parameters failed**  
Go back to the page, and set once more after identify input value.  
Push button showed "Reload parameters" when you want to identify set parameters.

## 6. SNTP

Set or change Ethernet (SNTP) parameters used to synchronize with the time server on the Internet.

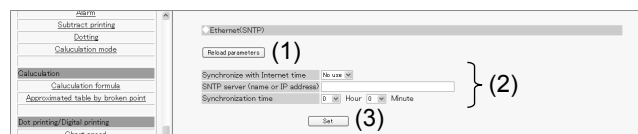

- (1) Clicking the [Reload parameters] button updates the display contents to those currently set on the unit.
- (2) Select or enter a value for each parameter. For details of the settings, refer to “SNTP Settings” in the instruction manual for “General” provided separately.
- (3) When the [Set] button is clicked, the display contents will be set onto the unit.

When an error is found in the settings, the following message will appear in the right frame.

**Setting parameters failed**  
Go back to the page, and set once more after identify input value.  
Push button showed "Reload parameters" when you want to identify set parameters.

## 10-8. SD Card

### 1. Recording measured value

Set or change parameters for recording measured value to SD card.

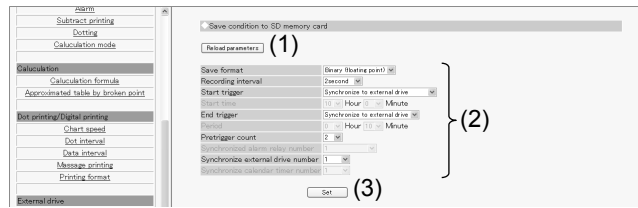

- (1) Clicking the [Reload parameters] button updates the display contents to those currently set on the unit.
- (2) Select a value for each parameter. For details of the settings, refer to “SD Card” in the instruction manual for “General” provided separately.

As shown in the following table, there are restrictions on a combination of start and end triggers. When the start trigger is changed, the end trigger will be changed to the default item.

		End trigger							
		Default	Key	Specified time	Alarm output linked	Remote contact linked	Chart recording linked	Chart end linked	Calendar timer linked
Start trigger	None	x	x	x	x	x	x	x	x
	Key	Key	O	O	x	x	x	x	x
	Specified time	Specified time	O	O	x	x	x	x	x
	Alarm output linked	Alarm output linked	O	O	O	x	x	x	x
	Remote contact linked	Remote contact linked	O	O	x	O	x	x	x
	Chart recording linked	Chart recording linked	x	O	x	x	O	x	x
	Chart end linked	Chart end linked	O	O	x	x	x	O	x
	Calendar timer linked	Calendar timer linked	O	O	x	x	x	x	O

- (3) When the [Set] button is clicked, the display contents will be set onto the unit.  
When an error is found in the settings, the following message will appear in the right frame.

Setting parameters failed  
Go back to the page, and set once more after identify input value.  
Push button showed "Reload parameters" when you want to identify set parameters.

## 10-9. System

### 1. Calendar timer

Set or change calendar timer parameters.

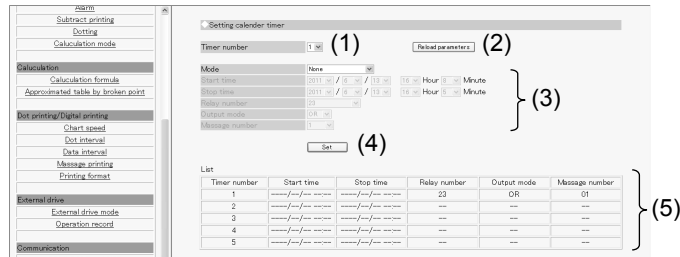

- (1) Select a timer number to be set. Up to five timers can be set.
- (2) Clicking the [Reload parameters] button updates the display contents to those currently set on the unit.
- (3) Select a value for each parameter. For details of the settings, refer to "Calendar Timer Settings" in the instruction manual for "General" provided separately.
- (4) When the [Set] button is clicked, the display contents will be set onto the unit.  
When an error is found in the settings, the following message will appear in the right frame.

Setting parameters failed  
Go back to the page, and set once more after identify input value.  
Push button showed "Reload parameters" when you want to identify set parameters.

- (5) A list of registered calendar timer settings is displayed

## 2. Display

Set or change display/illumination parameters.

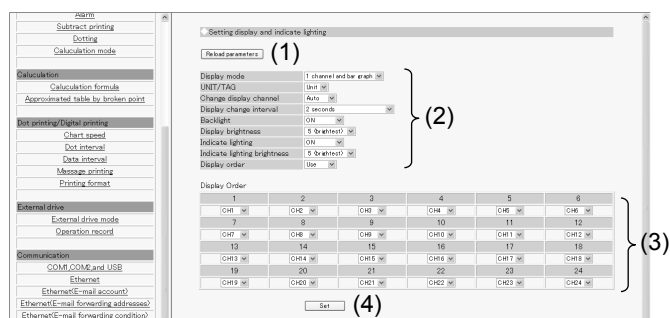

- (1) Clicking the [Reload parameters] button updates the display contents to those currently set on the unit.
- (2) Select a value for each parameter. For details of the settings, refer to “Display Settings” in the instruction manual for “General” provided separately.  
When the display order is set to “Use”, the display order section (3) will become available for selection.
- (3) Assign a channel to each number in the display order. For details of the settings, refer to “Measured Value Display Order Settings” in the instruction manual for “General” provided separately.
- (4) When the [Set] button is clicked, the display contents will be set onto the unit.  
When an error is found in the settings, the following message will appear in the right frame.

Setting parameters failed  
Go back to the page, and set once more after identify input value.  
Push button showed "Reload parameters" when you want to identify set parameters.

### 3. Fail out

Set or change fail out parameters.

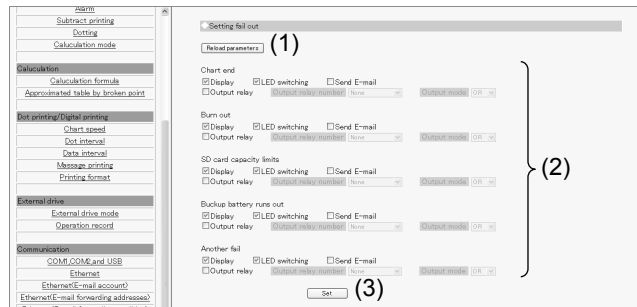

- (1) Clicking the [Reload parameters] button updates the display contents to those currently set on the unit.
  - (2) Select an action taken at an activation of each system related alarm (multiple selections available). For details of the settings, refer to “Fail Output Settings” in the instruction manual for “General” provided separately.
  - (3) When the [Set] button is clicked, the display contents will be set onto the unit.
- When an error is found in the settings, the following message will appear in the right frame.

**Setting parameters failed**  
 Go back to the page, and set once more after identify input value.  
 Push button showed "Reload parameters" when you want to identify set parameters.

### 4. Date and time

Set or change the date/time value.

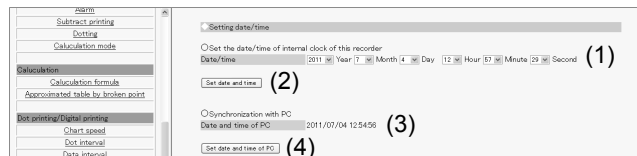

- (1) Select a value for each date/time parameter. When this window is displayed (updated), the date/time value currently set on the unit is read and displayed as default.
  - (2) When the [Set date and time] button is clicked, the display contents will be set onto the unit.
- When an error is found in the settings, the following message will appear in the right frame.

**Setting parameters failed**  
 Go back to the page, and set once more after identify input value.  
 Push button showed "Reload parameters" when you want to identify set parameters.

- (3) Current date/time on PC is displayed and updated every second.
  - (4) When the [Set date and time of PC] button is clicked, the display contents (3) will be set onto the unit.
- When an error is found in the settings, the above message will appear as described in step (2).

# Terms and Conditions

We would like to express our appreciation for your purchase and use of Azbil Corporation's products. You are required to acknowledge and agree upon the following terms and conditions for your purchase of Azbil Corporation's products (system products, field instruments, control valves, and control products), unless otherwise stated in any separate document, including, without limitation, estimation sheets, written agreements, catalogs, specifications and instruction manuals.

## 1. Warranty period and warranty scope

### 1.1 Warranty period

Azbil Corporation's products shall be warranted for one (1) year from the date of your purchase of the said products or the delivery of the said products to a place designated by you.

### 1.2 Warranty scope

In the event that Azbil Corporation's product has any failure attributable to azbil during the aforementioned warranty period, Azbil Corporation shall, without charge, deliver a replacement for the said product to the place where you purchased, or repair the said product and deliver it to the aforementioned place.

Notwithstanding the foregoing, any failure falling under one of the following shall not be covered under this warranty:

- (1) Failure caused by your improper use of azbil product (noncompliance with conditions, environment of use, precautions, etc. set forth in catalogs, specifications, instruction manuals, etc.);
- (2) Failure caused for other reasons than Azbil Corporation's product;
- (3) Failure caused by any modification or repair made by any person other than Azbil Corporation or Azbil Corporation's subcontractors;
- (4) Failure caused by your use of Azbil Corporation's product in a manner not conforming to the intended usage of that product;
- (5) Failure that the state-of-the-art at the time of Azbil Corporation's shipment did not allow Azbil Corporation to predict; or
- (6) Failure that arose from any reason not attributable to Azbil Corporation, including, without limitation, acts of God, disasters, and actions taken by a third party.

Please note that the term "warranty" as used herein refers to equipment-only-warranty, and Azbil Corporation shall not be liable for any damages, including direct, indirect, special, incidental or consequential damages in connection with or arising out of Azbil Corporation's products.

## 2. Ascertainment of suitability

You are required to ascertain the suitability of Azbil Corporation's product in case of your use of the same with your machinery, equipment, etc. (hereinafter referred to as "Equipment") on your own responsibility, taking the following matters into consideration:

- (1) Regulations and standards or laws that your Equipment is to comply with.
- (2) Examples of application described in any documents provided by Azbil Corporation are for your reference purpose only, and you are required to check the functions and safety of your Equipment prior to your use.
- (3) Measures to be taken to secure the required level of the reliability and safety of your Equipment in your use

Although azbil is constantly making efforts to improve the quality and reliability of Azbil Corporation's products, there exists a possibility that parts and machinery may break down.

You are required to provide your Equipment with safety design such as fool-proof design, \*1 and fail-safe design\*2 (anti-flame propagation design, etc.), whereby preventing any occurrence of physical injuries, fires, significant damage, and so forth. Furthermore, fault avoidance,\*3 fault tolerance,\*4 or the like should be incorporated so that the said Equipment can satisfy the level of reliability and safety required for your use.

\*1. A design that is safe even if the user makes an error.

\*2. A design that is safe even if the device fails.

\*3. Avoidance of device failure by using highly reliable components, etc.

\*4. The use of redundancy.

## 3. Precautions and restrictions on application

Azbil Corporation's products other than those explicitly specified as applicable (e.g. azbil Limit Switch For Nuclear Energy) shall not be used in a nuclear energy controlled area (radiation controlled area).

Any Azbil Corporation's products shall not be used for/with medical equipment.

The products are for industrial use. Do not allow general consumers to install or use any Azbil Corporation's product.

However, azbil products can be incorporated into products used by general consumers. If you intend to use a product for that purpose, please contact one of our sales representatives.

In addition,

you are required to conduct a consultation with our sales representative and understand detail specifications, cautions for operation, and so forth by reference to catalogs, specifications, instruction manual, etc. in case that you intend to use azbil product for any purposes specified in (1) through (6) below.

Moreover, you are required to provide your Equipment with fool-proof design, fail-safe design, anti-flame propagation design, fault avoidance, fault tolerance, and other kinds of protection/safety circuit design on your own responsibility to ensure reliability and safety, whereby preventing problems caused by failure or nonconformity.

- (1) For use under such conditions or in such environments as not stated in technical documents, including catalogs, specification, and instruction manuals
- (2) For use of specific purposes, such as:
  - \* Nuclear energy/radiation related facilities  
[For use outside nuclear energy controlled areas] [For use of Azbil Corporation's Limit Switch For Nuclear Energy]
  - \* Machinery or equipment for space/sea bottom
  - \* Transportation equipment  
[Railway, aircraft, vessels, vehicle equipment, etc.]
  - \* Antidisaster/crime-prevention equipment

- \* Burning appliances
  - \* Electrothermal equipment
  - \* Amusement facilities
  - \* Facilities/applications associated directly with billing
- (3) Supply systems such as electricity/gas/water supply systems, large-scale communication systems, and traffic/air traffic control systems requiring high reliability
  - (4) Facilities that are to comply with regulations of governmental/public agencies or specific industries
  - (5) Machinery or equipment that may affect human lives, human bodies or properties
  - (6) Other machinery or equipment equivalent to those set forth in items (1) to (5) above which require high reliability and safety
4. Precautions against long-term use
 

Use of Azbil Corporation's products, including switches, which contain electronic components, over a prolonged period may degrade insulation or increase contact-resistance and may result in heat generation or any other similar problem causing such product or switch to develop safety hazards such as smoking, ignition, and electrification. Although acceleration of the above situation varies depending on the conditions or environment of use of the products, you are required not to use any Azbil Corporation's products for a period exceeding ten (10) years unless otherwise stated in specifications or instruction manuals.
  5. Recommendation for renewal
 

Mechanical components, such as relays and switches, used for Azbil Corporation's products will reach the end of their life due to wear by repetitious open/close operations. In addition, electronic components such as electrolytic capacitors will reach the end of their life due to aged deterioration based on the conditions or environment in which such electronic components are used. Although acceleration of the above situation varies depending on the conditions or environment of use, the number of open/close operations of relays, etc. as prescribed in specifications or instruction manuals, or depending on the design margin of your machine or equipment, you are required to renew any Azbil Corporation's products every 5 to 10 years unless otherwise specified in specifications or instruction manuals. System products, field instruments (sensors such as pressure/flow/level sensors, regulating valves, etc.) will reach the end of their life due to aged deterioration of parts. For those parts that will reach the end of their life due to aged deterioration, recommended replacement cycles are prescribed. You are required to replace parts based on such recommended replacement cycles.
  6. Other precautions
 

Prior to your use of Azbil Corporation's products, you are required to understand and comply with specifications (e.g., conditions and environment of use), precautions, warnings/cautions/notices as set forth in the technical documents prepared for individual Azbil Corporation's products, such as catalogs, specifications, and instruction manuals to ensure the quality, reliability, and safety of those products.
  7. Changes to specifications
 

Please note that the descriptions contained in any documents provided by azbil are subject to change without notice for improvement or for any other reason. For inquires or information on specifications as you may need to check, please contact our branch offices or sales offices, or your local sales agents.
  8. Discontinuance of the supply of products/parts
 

Please note that the production of any Azbil Corporation's product may be discontinued without notice. For repairable products, we will, in principle, undertake repairs for five (5) years after the discontinuance of those products. In some cases, however, we cannot undertake such repairs for reasons, such as the absence of repair parts. For system products, field instruments, we may not be able to undertake parts replacement for similar reasons.
  9. Scope of services
 

Prices of Azbil Corporation's products do not include any charges for services such as engineer dispatch service. Accordingly, a separate fee will be charged in any of the following cases:

    - (1) Installation, adjustment, guidance, and attendance at a test run
    - (2) Maintenance, inspection, adjustment, and repair
    - (3) Technical guidance and technical education
    - (4) Special test or special inspection of a product under the conditions specified by you

Please note that we cannot provide any services as set forth above in a nuclear energy controlled area (radiation controlled area) or at a place where the level of exposure to radiation is equivalent to that in a nuclear energy controlled area.



*Specifications are subject to change without notice.* (09)

**[Selling agency]**

**Azbil Corporation**  
Advanced Automation Company

1-12-2 Kawana, Fujisawa  
Kanagawa 251-8522 Japan

URL: <http://www.azbil.com>

**[Manufacturer]**

**CHINO Corporation**

32-8 KUMANO-CHO, ITABASHI-KU,  
TOKYO 173-8632 JAPAN

1st edition: Nov. 2013 (K)

3rd edition: Apr. 2016 (K)