

Worcester WK70 / WKB70 Series

Full bore clean valves

WCENIM0041-01

Original Instructions

**Installation
Operation
Maintenance**

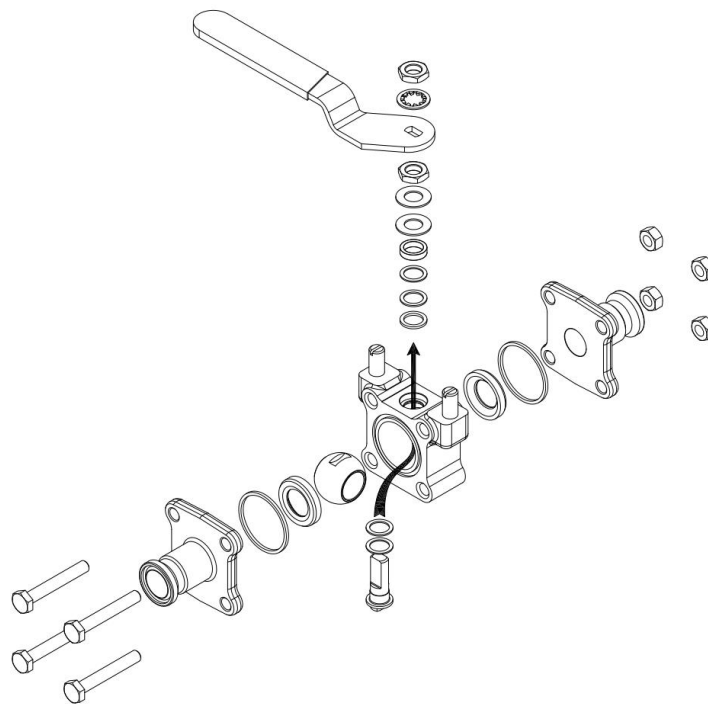

Copyright

All rights reserved. No part of these instructions may be reproduced, stored in a retrieval system or transmitted in any form or by any means without prior permission of Flowserve Flow Control.

Document Version

Initial Release, 01-APR-2018

 ***These instructions must be read prior to installing, operating, and maintaining this equipment.***

CONTENTS

1 General Information 2

1.1 Scope of manual 2

1.2 Disclaimer 2

2 Health and Safety 3

3 Product Information 4

3.1 Certification 4

3.2 Design 5

4 Storage 5

5 Installation 6

5.1 Preparation 6

5.2 Installation 6

6 Operation 7

6.1 Use 7

6.2 Manual operation 7

6.3 Remote operation 7

7 Maintenance 8

7.1 General 8

7.2 In-line leakage 8

7.3 Stem leakage 8

7.4 Body/Connector leakage 8

8 Repair Kits 8

9 Refurbishment 9

9.1 Disassembly 9

9.2 Reassembly 10

10 Technical Data 12

10.1 Gland nut torque 12

10.2 Stem assembly torque 12

10.3 Connector bolt torque 12

10.4 Torque data 12

11 Valve Exploded View Diagram 13

11.1 WK70 13

11.2 WKB70 – Machined from bar variant 14



These instructions must be read prior to installing, operating, and maintaining this equipment.

1 General Information

 ***These instructions must be read prior to installing, operating, and maintaining this equipment.***

 ***These instructions must be read prior to installing, operating, using, or maintaining the equipment in any region worldwide. The equipment must not be put into service until all of the safe operating conditions noted in the instructions have been met. Failure to comply with the information provided in the User Instructions is considered to be misuse. Personal injury, product damage, delay in operation, or product failure caused by misuse are not covered by the Flowserve warranty.***

1.1 Scope of manual

These instructions must be kept close to the product's operating location or directly with the product.

These instructions must be read prior to installing, operating, using, or maintaining the equipment in any region worldwide. The equipment must not be put into service until all of the safe operating conditions noted in the instructions have been met. Failure to comply with the information provided in the User Instructions is considered to be misuse. Personal injury, product damage, delay in operation, or product failure caused by misuse are not covered by the Flowserve warranty.

This document covers the Worcester WK70 / WKB70 series:

Pressure rating – Variable

Size range – DN 15 – 50, NPS ½ - 2

1.2 Disclaimer

Information in this User Instruction is believed to be complete and reliable. In spite of all Flowserve's efforts to provide comprehensive information and instructions, sound engineering and safety practices should always be used. Please consult with a qualified engineer.

Flowserve manufactures products to applicable International Quality Management System Standards as certified and audited by external Quality Assurance organizations. Genuine parts and accessories have been designed, tested, and incorporated into the products to help ensure continued product quality and performance in use. As Flowserve cannot test parts and accessories sourced from other vendors the incorrect incorporation of such parts and accessories may adversely affect the performance and safety features of the product. The failure to properly select, install, or use authorized Flowserve parts and accessories is considered to be misuse. Damage or failure caused by misuse is not covered by Flowserve's warranty. In addition, any modification of Flowserve products or removal of original components may impair the safety of these products in use.

2 Health and Safety

The product/system must not be operated beyond the parameters specified for the application. If there is any doubt as to the suitability of the product/system for the application intended, contact Flowserve for advice, quoting the serial number.

When installing, operating or maintaining valves:

- a) Complete a risk assessment and eliminate or reduce hazards to an acceptable level.
- b) Work in accordance with safe systems of work.
- c) Observe all site health and safety rules.
- d) Wear all the necessary personal protective equipment (PPE).
- e) Never remove or maintain a valve or joint unless the line has been fully depressurised, drained, and where necessary, purged of toxic / explosive / flammable media. Always operate the valve to the open position to ensure that no trapped pressure exists within the cavity.
- f) Never handle valves that have been used on harmful substances unless they have been completely decontaminated and certified safe to handle.
- g) Never use a valve on an application which exceeds its prescribed operating parameters. Refer to Flowserve Flow Control technical sales for performance curves for further information.
- h) Never modify or alter valves unless the manufacturer has been consulted or recommends such changes.
- i) Wrenches are only designed to operate the valves and must not be used to carry them as it may result in operator injury or damage to the valve stem and sealing.
- j) Use appropriate lifting methods and equipment when installing, maintaining and removing the product. Ensure that the valve is correctly supported in its operating location.
- k) The valve must be installed in a system design to prevent excessive forces on the flanges and connectors.
- l) Consult Flowserve Flow Control technical sales before equipment is installed in areas subject to seismic activity or extreme climates.
- m) The valve should be protected by other devices to prevent over-pressurisation, e.g. increased pressure caused by external fire.
- n) It is the end user's responsibility to ensure compatibility of the media with the materials of construction of the product. The integrity of the valve may be affected by the effects of corrosion and erosion.
- o) If the processes or environments that the valve is used in are likely to cause temperatures (high or low) that may cause injury to personnel if touched, adequate protection must be fitted on the valve.
- p) If the valve is to be used for unstable gas applications, ensure that the operational parameters as indicated on the product identification plate cannot be exceeded.

3 Product Information

3.1 Certification

This product is compliant with the following EU regulations:

- a) Pressure Equipment Directive (PED) 2014/68/EU: If the ID plate carries the CE mark, PED number '2014/68/EU', and the notified body identity number '0086', the product complies with the PED. If these numbers are not present, the product is classified under Sound Engineering Practice (SEP) and may only be used within the limitations defined in tables 6, 7, 8 and 9 of the PED.
- b) Explosive Atmospheres (ATEX) 2014/34/EU: If the ID plate carries the CE mark, ATEX number '2014/34/EU', the explosion protection symbol, and ATEX codes identifying the equipment, the product complies with the ATEX directive.

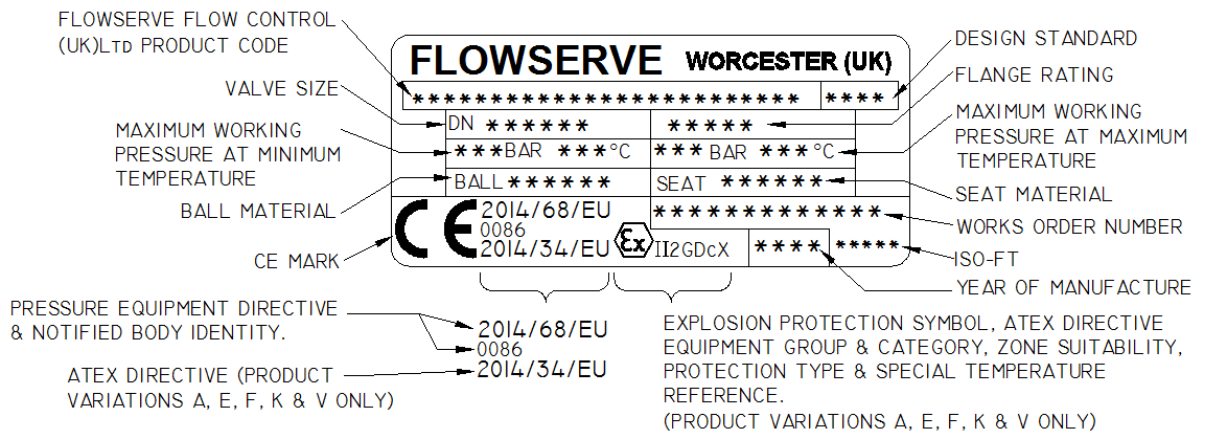

Figure 1 Valve ID plate markings (DN 32 and above)

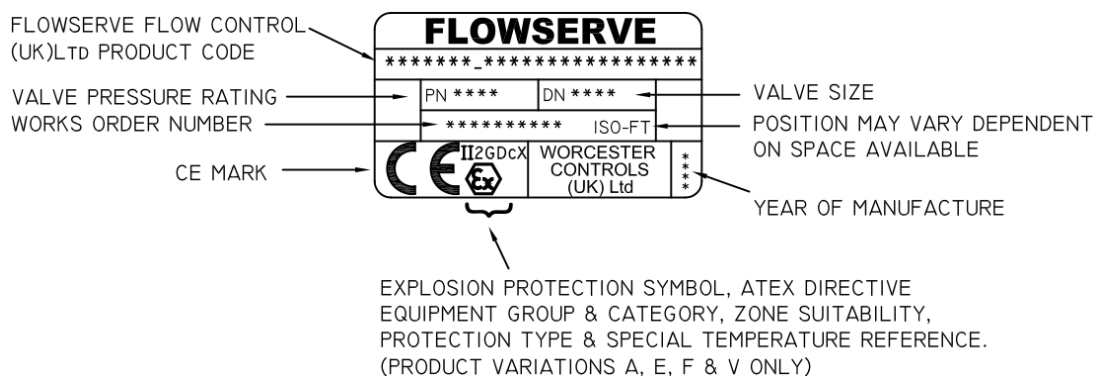

Figure 2 Valve ID plate markings (DN 25 and below)

Table 1 ATEX marking definitions

II	Equipment group
2	Equipment category
G	Gas zone suitability (zones 1 & 2)
D	Dust zone suitability (zones 1 & 2)
c	Type of protection (constructional safety) (as per BS EN ISO 80079-37)
X	Special temperature reference. Surface temperature: As per BS EN ISO 80079-36, the temperature class or maximum surface temperature cannot be marked on the product as it is dependent on the operating conditions. However, the maximum/minimum allowable operating temperatures for the product are marked on the identification plate.

3.2 Design

- a) End flanges: The end flange design of this product has been verified by either 2017 ASME BPVC Section VIII Division 1 – Calculation Method, by finite element analysis in accordance with 2017 BPVC Section VIII Division 2 – Alternative Rules, or by experimental testing as defined in BS EN 12516-3 – Experimental Method.
- b) Bolting: End flanges have been verified by the methods stated above, using bolt design stress values based on those for ASTM A193 B8 Class 2 for stainless steel valves and ASTM A320 L7 for carbon steel valves as defined in ASME BPVC Section II Part D.
- c) Gaskets: Spiral wound gaskets in accordance with BS EN 1514 for PN rated flanges and ASME B16.20 for Class rated flanges. These have gasket factors and design stresses of 2.50 and 69 MPa respectively for carbon steel gaskets, and 3.00 and 69 MPa respectively for stainless steel gaskets as defined in 2017 ASME BPVC Section VIII Division 1. If gaskets with higher gasket factors and design stresses are used, please consult Flowserve Flow Control technical sales.
- d) Lethal Service: In accordance with ASME BPVC Section VIII Division 1, a casting quality factor of 1.0 is allowable for all products. Those intended for 'lethal service' must have had non-destructive examination carried out in accordance with Appendix 7 of ASME BPVC Section VIII Division 1. Refer to Flowserve Flow Control technical sales for more information.

4 Storage

- a) All valves are despatched in the open position and it is recommended that they are left in this position during storage.
- b) All protective packaging should remain in this position until the valve is to be installed.
- c) Valves should be stored in a clean, dry environment.
- d) Carbon steel valves are phosphate and coated with a de-watering oil. This coating is non-toxic and is quite safe on edible or potable products.

5 Installation

5.1 Preparation

- a) The working area should be clean and clear of any debris that would contaminate the valve.
- b) When despatched, valves contain a mineral oil which aids the bedding in of the valve. This may be removed if found unsuitable. Special variants may contain other lubricants or be dry built.
- c) Some valves contain a silica gel pack inside the ball cavity to absorb humidity during storage. These must be removed before installation along with all other protective packaging.
- d) The gland nut locking clip must be retained at all times. During installation, if the locking clip is not in place, the gland nut must be adjusted to the correct torque and a new locking clip must be fitted.
- e) Significant problems can arise with any valve installed in an unclean pipeline. Ensure that the pipeline has been flushed clean of dirt, weld spatter etc. before installation.
- f) Graphite seals should be handled with care due to their delicate nature.
- g) If transit seals are fitted inside the valve, these must be discarded and replaced with the spare body seals supplied.

5.2 Installation

- a) Standard valves are bi-directional and may be installed in either direction. Valves with an upstream pressure relief hole (Q190 ball) are uni-directional and must be fitted with the flow arrow pointing downstream.
- b) It is recommended that the valves are in the open position during fitting.
- c) Weld end valves (standard length ends):
 - Fully assembled weld end valves (butt and socket), must only be tack-welded into position, as the full weld heat will damage the seats and seals.
 - After tack welding, remove the body assembly as per section 9.1.
 - Complete the welding procedure after protecting the connector end faces from weld spatter.
 - When cool, clean the valve connector end faces and then fit the new body seals (supplied) into the body. Reassemble the valve as per section 9.2.
- d) Weld end valves (XBO):
 - Extended butt weld O/D ends (XBO) are suitable for orbital welding directly in-line without needing to dismantle the valve. After successful completion of the orbital welding process, allow the ends to cool then inspect and clean the joint as necessary.
 - If welding of XBO ends is conducted using a manual welding process, it is advisable to follow the procedure outlined in paragraph 5.2.c to prevent excessive heat transfer to the valve seals.

6 Operation



The product/system must not be operated beyond the parameters specified for the application. If there is any doubt as to the suitability of the product/system for the application intended, contact Flowserve for advice, quoting the serial number.

6.1 Use

Worcester valves provide bubble-tight shut off when used in accordance with Worcester published pressure / temperature charts.

Metal seats fitted downstream provide shut off to FCI 70-2 1998, Class VI.

It is not good practice to leave a soft-seated ball valve in the partially open position as this will damage the seats and reduce valve life. Flow control ball valves, which contain seats for this purpose, are available from Flowserve Flow Control.

Media which may solidify, crystallise, or polymerise, should not be allowed to stand in the ball cavity, as this is detrimental to valve performance and life.

6.2 Manual operation

- a) The basic type of wrench on DN 15 – 50 (NPS ½ - 2) valves is made of sheet steel with an integral stop. Larger sizes of valves have a cast wrench head and a tubular handle secured to the stem by a wrench bolt.
- b) Worcester valves have a quarter turn operation, closing in a clockwise direction. It is possible to see when the valve is open or closed by the position of the wrench. When the wrench is in line with the pipeline, the valve is open. When the wrench is across the pipeline, the valve is closed. If the wrench is removed, the flats of the stem will also indicate valve position.
- c) When operating the valve, avoid excessive loads on the wrench.

6.3 Remote operation

- a) Where automation of valves is required, Flowserve Flow Control can supply pneumatic and electric actuators to cover a wide range of operating torques.
- b) Operation will be in accordance with installation, operation, and maintenance instructions for the relevant actuator.

7 Maintenance

7.1 General

Worcester valves are trouble free and maintenance is rarely needed. The following checks will help extend life further and reduce downtime:

- a) Every 25 000 cycles or three months, check for signs of leakage (section 7.2, 7.3, 7.4) and that all fasteners (including gland nut) are tightened to their correct torque value (see section 10)
- b) The valve should not be left standing without operation for more than one month. After this period, the valve should be operated through three full cycles.
- c) The valve should not be left in a partially opened position as this may cause damage to the seat and reduce its life.

7.2 In-line leakage

Any leakage when the valve is fully closed will be due to damage to the body, seat or ball sealing surfaces. It will be necessary to disassemble and repair the valve (see section 9).

7.3 Stem leakage

Remove the wrench (see section 9) or the actuator (see appropriate IOM), followed by the gland nut locking clip, and tighten the gland nut to the correct torque (see section 10.1). If leakage persists, it may be necessary to replace gland packings and thrust seals (see section 9).

7.4 Body/Connector leakage

Ensure that the body bolting is tightened to the correct torque (see section 10.3). If leakage persists, remove the valve from line and replace the body seal and also establish whether the seal faces of the body and connector have been damaged.

8 Repair Kits

- a) Repair kits are available for all Worcester valves. Details of their contents are found in the instruction sheet supplied with the kit.
- b) If other parts are required, it is usually recommended that the complete valve is replaced. Parts from different sized/rated valves must not be interchanged.
- c) Only Worcester authorised spare parts should be used. This includes basic components such as fasteners. Flowserve Flow Control accepts no responsibility if the valve is altered in any way without consent.

9 Refurbishment

Refer to the health and safety (see section 2) before starting any refurbishment work. Never remove or perform maintenance on a valve or flange joint unless the line has been fully depressurised, drained and where necessary, purged of toxic, explosive, or flammable media.

9.1 Disassembly

- a) Set the valve in open position (wrench / stem flats in line with the pipeline) to prevent the ball protruding out of the body and fouling on the body connectors when the body is removed.
- b) The body connectors must be pulled apart slightly to prevent scoring of the machined faces. The fire-safe valves, the connectors must be pulled apart even further to allow clearance for the body seal spigot.
- c) There are two methods of removing the valve from the pipeline:
 - a. 'Slide out' method: Extract all the body bolts and slide the body completely from the two body connectors. Take care not to damage the connector sealing faces.
 - b. 'Swing out' method: If only partial removal of the valve from the pipeline is required (to change only seats, seals, or ball), extract any three bolts and slightly loosen the last. The body may then be rotated from between the two body connectors, using the last remaining bolt as a pivot.

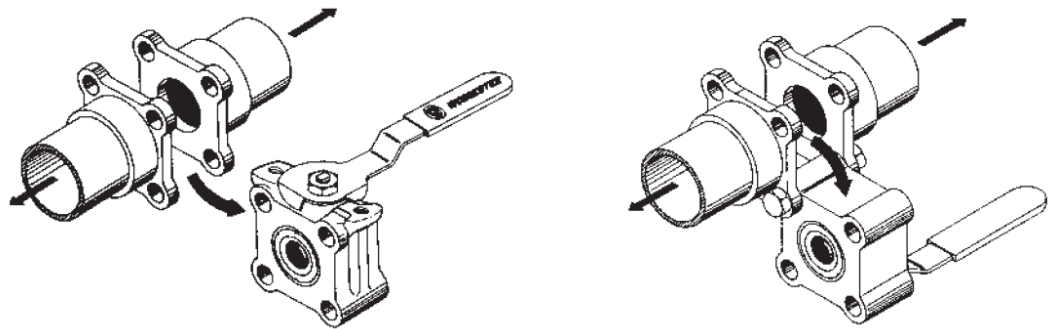

Figure 3 'Slide-out' method (left), 'Swing-out' method (right)

- d) Remove and discard the seats and body seals.
- e) Close the valve and using a soft drift, tap out the ball.
- f) To dismantle the stem assembly, remove:
 - Wrench assembly (if fitted)
 - Gland nut locking clip
 - Gland nut
 - Belleville washers
 - Gland
- g) Remove the stem through the body. For DN 15 valves, remove the gland packing and align the stem wrench flats across the valves to facilitate stem

removal. The gland packing and thrust seal can now be removed, taking care not to damage the sealing faces.

- h) All components not replaced by parts in the repair kit should be thoroughly cleaned and stored in a clean, secure area.
- i) All sealing faces on the body, connector and ball must be checked for corrosion, erosion and scratches. If damage is found or there is any reason to believe that a part is damaged, replace the part.
- j) Valve parts should be cleaned using a suitable degreasing agent. Hard deposits can be removed using stainless steel wire wool. Care should be taken to avoid damaging sealing faces.

9.2 Reassembly

- a) Ensure that the repair kit and/or spare parts are suitable for the valve being refurbished.
- b) Cleanliness is essential for long valve life. The seats may be lightly lubricated with a light oil to aid bedding in. Ensure that the lubricant is compatible with the pipeline media, and the pressure and temperature of the application.
- c) Fit a new thrust seal on the stem (see section 11) and insert the stem through the valve body from inside the valve cavity. Tweezers may make it easier to do so on DN 15 valves.
- d) Fit the new gland packings into the body recess and the gland and the new Belleville washers (with their outer edges touching) on the stem.
- e) While preventing the stem from turning, tighten the gland nut to the correct torque (see section 10.1). Operate the stem several times and re-adjust the gland nut to the specified figure. Over-tightening of the gland nut will reduce the life of the stem assembly.
- f) Fit the locking clip correctly as shown in Figure 4.

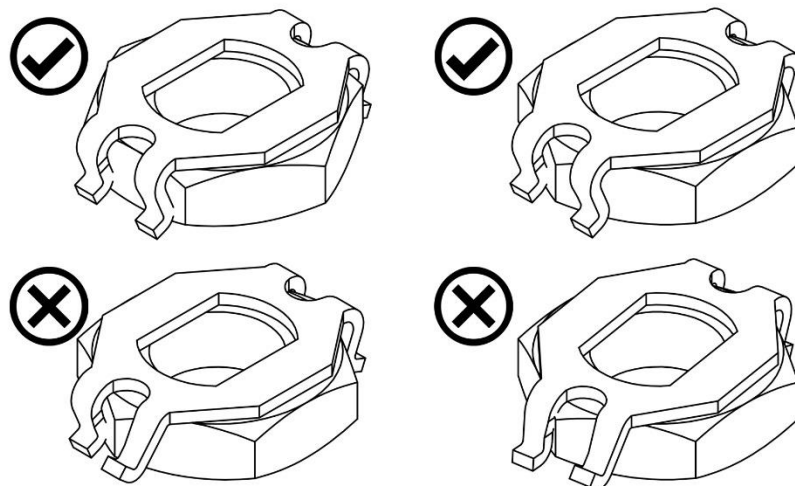

Figure 4 Fitting the locking clip

- g) Fit the wrench assembly (if required).
- h) Turn the stem to the valve closed position and slide the ball into the body, locating on the stem bottom drive. Turn the stem to the valve open position to prevent the ball from falling out.
- i) Fit the new seats and body seals.

- j) Clean the sealing faces of the body connectors before refitting. On AF variants, refit the location rings. The body connectors must be pulled apart to place the body back into position without damaging the seats, seals, and sealing faces.
- k) Centralise the body, replace the body bolts and tighten diagonally and evenly to the correct torque (see section 10.3).
- l) If practical, leak tightness and operating torque should be checked prior to refitting the valve in line.

10 Technical Data

10.1 Gland nut torque

The torque to be applied to the gland nut to ensure the correct amount of stem sealing.

10.2 Stem assembly torque

The torque required to operate the assembled stem before the ball and seats are fitted to the valve.

10.3 Connector bolt torque

The torque required to give a metal-to-metal contact between the body and the inner surface of the body connectors.

10.4 Torque data

Table 2 Torque Data

Size (Reduced Bore)	Size (Full Bore)	Gland nut – graphite build (Nm)	Gland nut – PTFE build (Nm)	Stem assembly (Nm)	Connector bolts (Nm)	Connector cap screws (Nm)	
DN 15		5 – 7	6 – 9	3 – 5	11 – 13	24 – 28	
DN 20	DN 15	5 – 7	6 – 9	3 – 5	13 – 15	25 – 29	
DN 25	DN 20	6 – 10	8 – 12	4 – 6	24 – 28	27 – 31	
DN 32	DN 25	6 – 10	8 – 12	4 – 6	28 – 32	31 – 35	
DN 40	DN 32	8 – 12	13 – 18	6 – 8	33 – 37	35 – 39	
DN 50	DN 40	8 – 12		13 – 18	6 – 8	38 – 42	49 – 53

11 Valve Exploded View Diagram

11.1 WK70

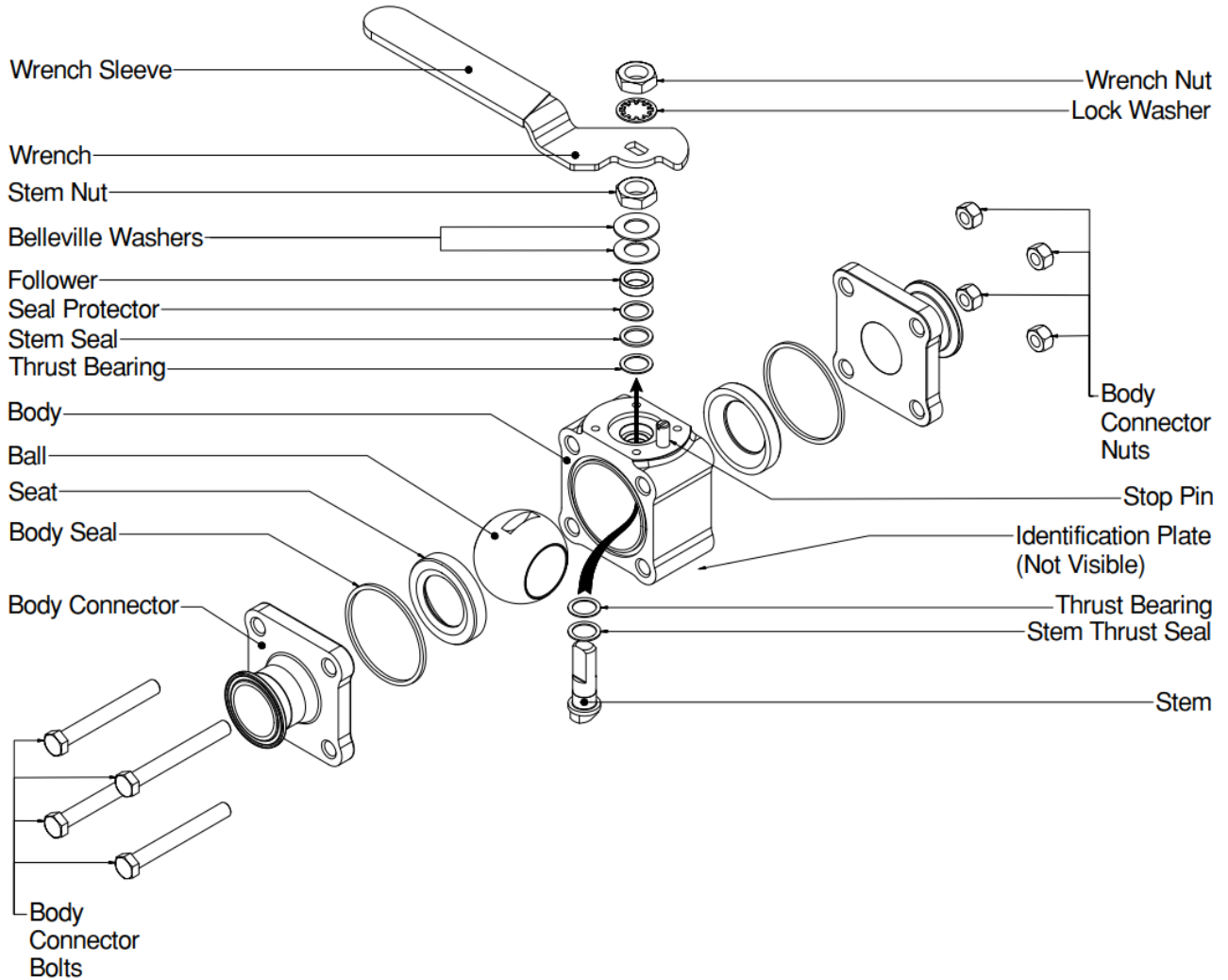

11.2 WKB70 – Machined from bar variant

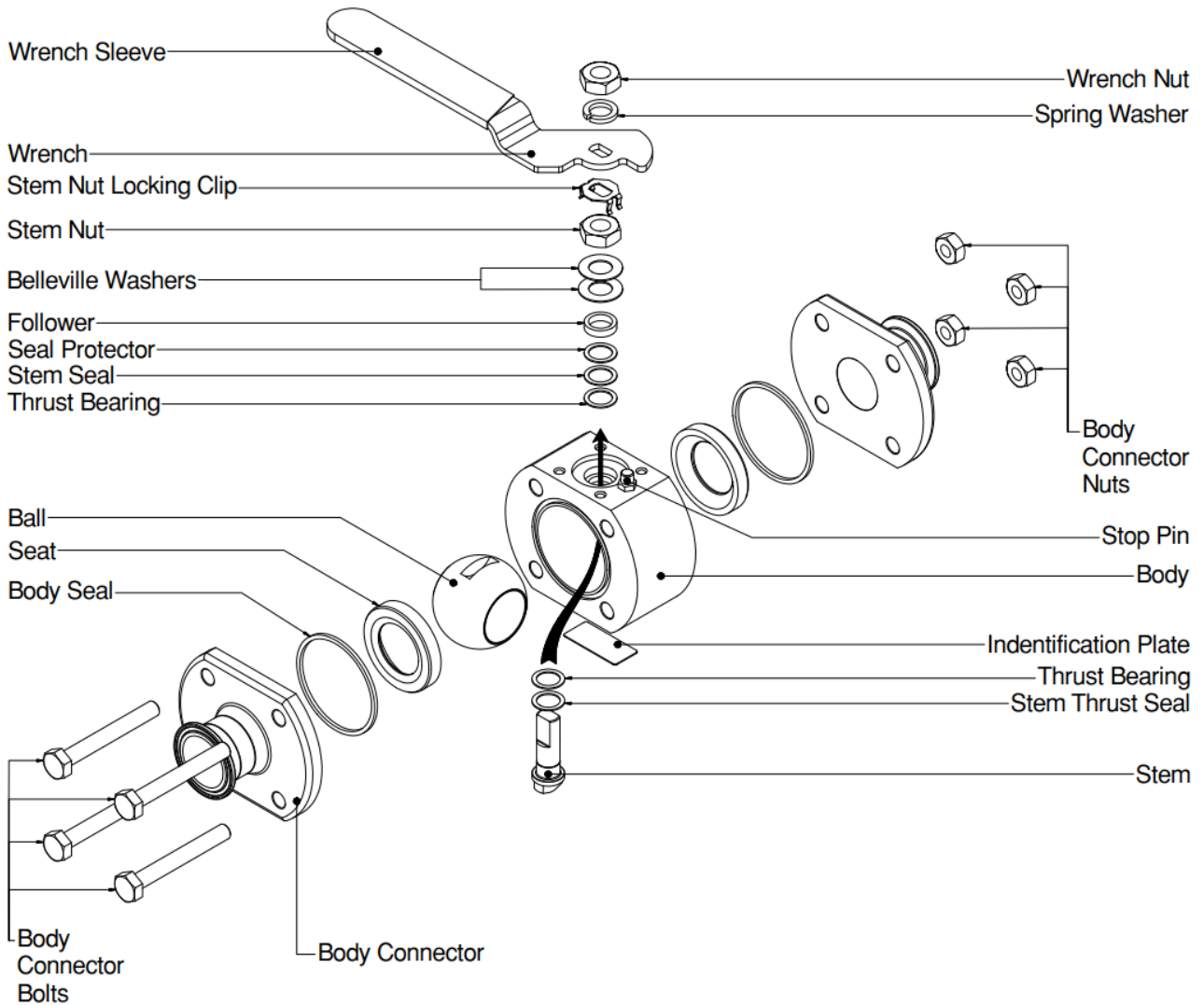



Flowserve factory contacts:

Flowserve Flow Control
A Division of Flowserve GB Ltd.
Burrell Road
Haywards Heath
RH16 4HR
United Kingdom

Telephone: +44 (0)1444 314400

FLOWSERVE REGIONAL SALES OFFICES:

Local Flowserve representative:

To find your local Flowserve representative use the Sales Support Locator System found at www.flowserve.com

Flowserve Corporation has established industry leadership in the design and manufacture of its products. When properly selected, this Flowserve product is designed to perform its intended function safely during its useful life. However, the purchaser or user of Flowserve products should be aware that Flowserve product might be used in numerous application under a wide variety of industrial service conditions. Although Flowserve can (and often does) provide general guidelines, it cannot provide specific data and warnings for all possible applications. The purchaser/user should read and understand the User Instructions: Installation Operation Maintenance included with the product, and train its employees and contractors in the safe use of Flowserve products in connection with its application

While the information and specifications contained in this literature are believed to be accurate, they are supplied for informative purpose only and should not be considered certified or as a guaranteed of satisfactory results by reliance thereon. Nothing contained herein is to be construed as a warranty or guarantee, express or implied, regarding any matter with respect to the product. Because Flowserve is continually improving and upgrading its product design, the specifications, dimensions and information contained herein are subject to change without notice. Should any question arise concerning these provisions, the purchaser/user should contact Flowserve Corporation at any one of its worldwide operations or offices.

© 2017 Flowserve Corporation, Irving, Texas, USA. Flowserve is a registered trademark of Flowserve Corporation