





Fittings for UNF connections with PTFE hose for analysis valves with UNF-1/4-28 connection

- Screw joints for laboratory applications
- Connection cavity-free
- No media turbulence
- Reliable seal
- Materials PP, PEEK, PPS, ETFE, PTFE



Product variants described in the data sheet may differ from the product presentation and description.

Can be combined with

	Type 6604 ▶ 2/2 or 3/2 way Flip-per-Solenoid Valve with separating diaphragm
	Type 6606 ▶ 2/2 or 3/2 way Rocker-Solenoid Valve with separating diaphragm
	Type 0127 ▶ Direct-acting 2/2 or 3/2 way Rocker-Solenoid Valve with separating diaphragm

Type description

In medical, biological and chemical laboratory and analysis technology, UNF threads in combination with fittings are typically used to connect hoses (PTFE, ...) and pipes/capillaries (VA, PEEK, ...). Bürkert valves of types 0117, 0127, 6126, 6606, 6650, 6624, 6712 and 6724 are available with a UNF-1/4-28 thread. Fittings for UNF connections consist of a basic screw joint and a clamping sleeve. The connections can be assembled very easily and quickly. They are cavity-free and prevent the medium from swirling when it is transferred from the valve to the hose. Assembly instructions: Tighten basic screw joint hand-tight only, never squeeze it. The clamping sleeve and the hose form a reliable seal without the use of other materials.

Table of contents

1. General technical data	3
2. Product versions	3
3. Dimensions	4
3.1. Straight basic screw connections with UNF ¼ -28-thread.....	4
4. Product design and assembly	4
4.1. Product features	4
5. Ordering information	5
5.1. Bürkert eShop – Easy ordering and quick delivery.....	5
5.2. Bürkert product filter	5
5.3. Ordering chart.....	5

1. General technical data

Product properties	
Dimensions	Detailed information can be found in chapter Cross reference .
Materials	
Basic screw connection	PEEK, PP, PPS
Clamping sleeve	ETFE (TEFZEL)
Valve connecting thread	UNF ¼ -28
Hose outer diameter	1/16" (1,6 mm) ⅜" (3,2 mm)
Pressure for clamping sleeve ^{1.)}	Max. 131 bar

1.) The pressure was measured at + 20 °C with water. It refers only to the joint.

2. Product versions

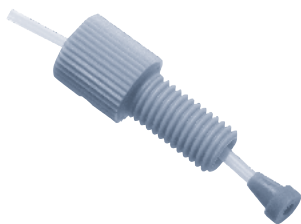

Version type 1013-AA 05 with 1/16"-tube
Basic screw connection: PP and PEEK

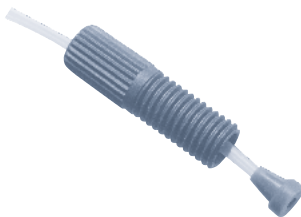

Version type 1013-AA 05 with 1/16"-tube
Basic screw connection: PPS

3. Dimensions

3.1. Straight basic screw connections with UNF ¼ - 28-thread

Note:

Dimensions in mm

Mounting instruction:

Only tighten the basic screw connection by hand, never squeeze it. The clamping sleeve forms a reliable seal with the hose without further use of material.

Version PP and PEEK; for 1/16- and 1/8- hose outer diameter

Version PPS, for 1/16 and 1/8 hose outside diameter

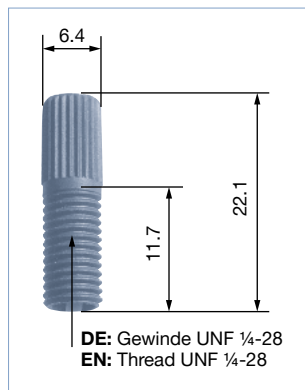
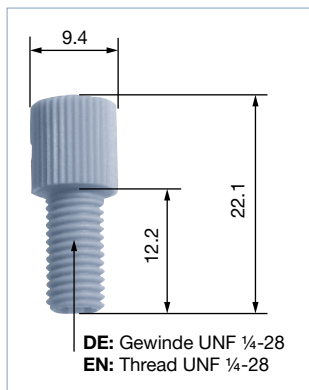

Clamping sleeve for hose outer diameter 1/16", color blue

Clamping sleeve for hose outer diameter 1/8", colour yellow

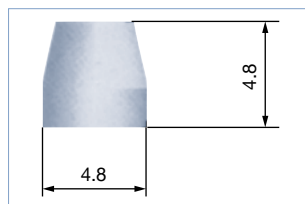
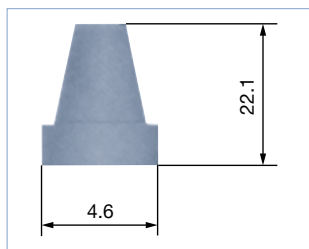

4. Product design and assembly

4.1. Product features

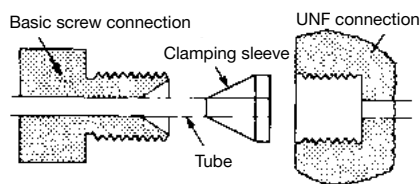
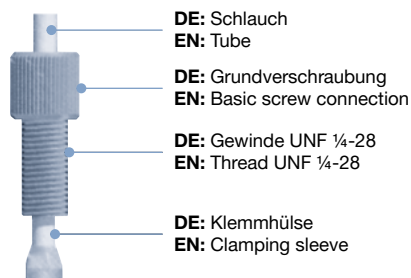

5. Ordering information

5.1. Bürkert eShop – Easy ordering and quick delivery



Bürkert eShop – Easy ordering and fast delivery

You want to find your desired Bürkert product or spare part quickly and order directly? Our online shop is available for you 24/7. Sign up and enjoy all the benefits.

[Order online now](#)

5.2. Bürkert product filter













Bürkert product filter – Get quickly to the right product

You want to select products comfortably based on your technical requirements? Use the Bürkert product filter and find suitable articles for your application quickly and easily.

[Try out our product filter](#)

5.3. Ordering chart

Version	Hose outer diameter	Materials	Colour	Delivery quantity	Article no.
Straight basic fittings with thread	1/16" (1,6 mm)	PP	white	1 piece	787065 
		PPS	black	1 piece	787063 
		PEEK	beige	1 piece	787064 
UNF ¼ - 28	⅜" (3,2 mm)	PP	white	1 piece	787062 
		PEEK	beige	1 piece	787061 
Clamping sleeves	1/16" (1,6 mm)	ETFE	blue	1 piece	787058 
	⅜" (3,2 mm)	ETFE	yellow	1 piece	787059 
Tubes	Øa x Øi = 1,6 mm (1/16") x 0,8 mm	PTFE	white	10 m	784360 
	Øa x Øi = 1,6 mm (1/16") x 1,0 mm	PTFE	white	10 m	784361 
	Øa x Øi = 3,2 mm (⅜") x 1,6 mm	PTFE	white	10 m	784362 

Bürkert – Close to You

For up-to-date addresses
please visit us at
www.burkert.com

DTS 1000404527 EN Version: - Status: RL (released | freigegeben | validé) printed: 24.10.2019

