



Individual Wiring HART Communication Interface Unit

HART® NETWORK UNIT (HNU)

The HART Network Unit (HNU) is a communication interface unit for use between HART-compatible field devices (HART devices) and Azbil Corporation's InnovativeField Organizer (IFO) device management system.

The HNU enables any DCS and/or PLC, regardless of manufacturer or type, to communicate with HART devices and with the IFO by individual wiring to analog I/O terminals of the DCS or relay terminals in the marshaling rack.

The HNU achieves one-second updates for all points by using 16-channel parallel, simultaneous communication. Combined with flexible installation into existing systems, the HNU provides convenient device management using the IFO to all HART device users.

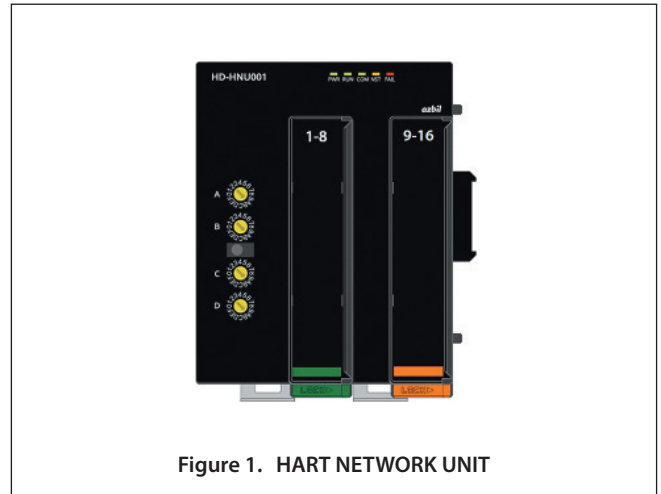

Figure 1. HART NETWORK UNIT

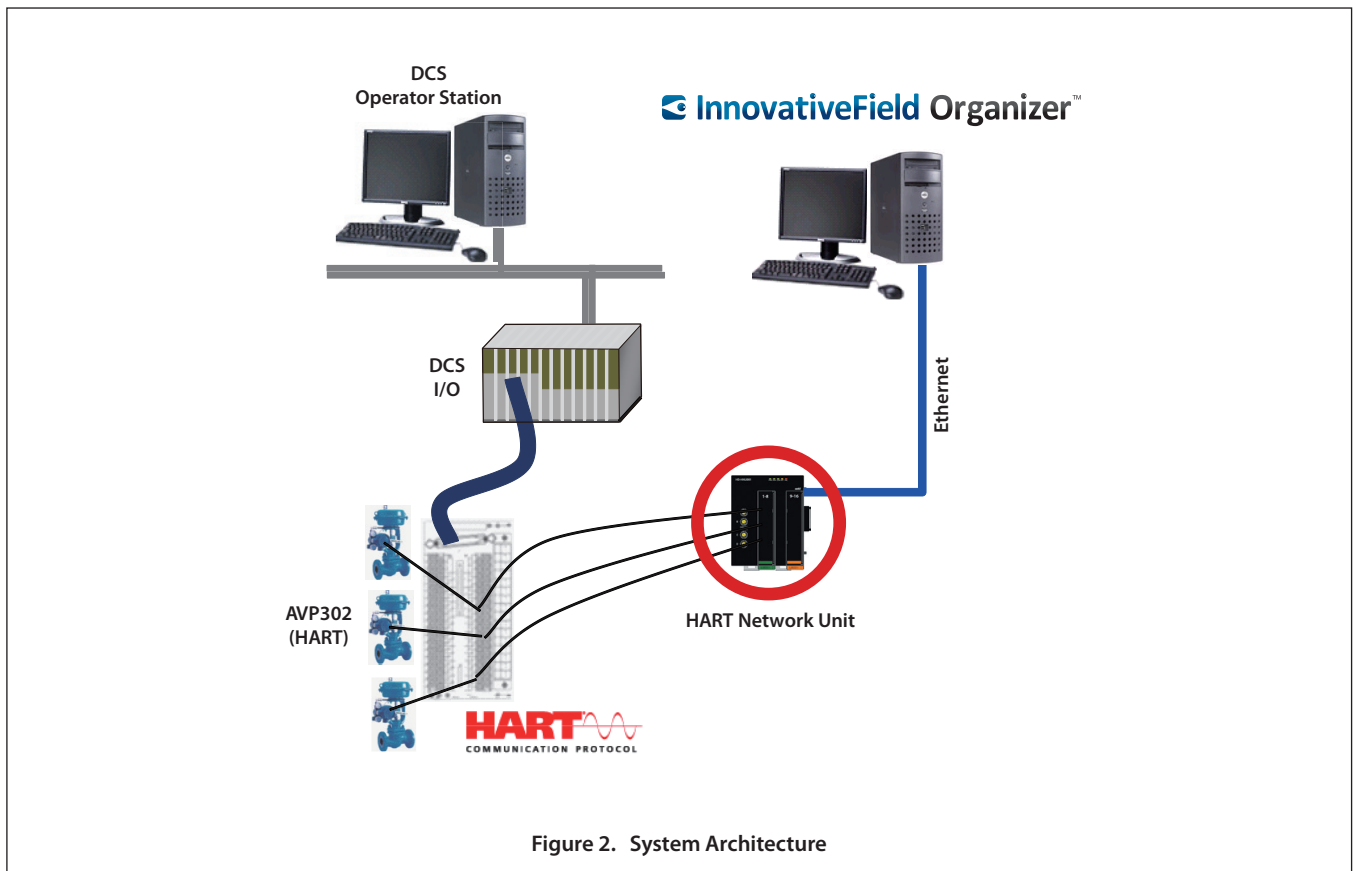

Figure 2. System Architecture

1. Features

Fast One-Second Updates for All Points

A HART modem is included in each communication channel of the HNU and 16-channel parallel, simultaneous communica-

tion is used to achieve fast, one-second updates for all points. The superior real-time processing performance offers a solution to the poor operability and responsiveness experienced with general-use multiplexer systems.

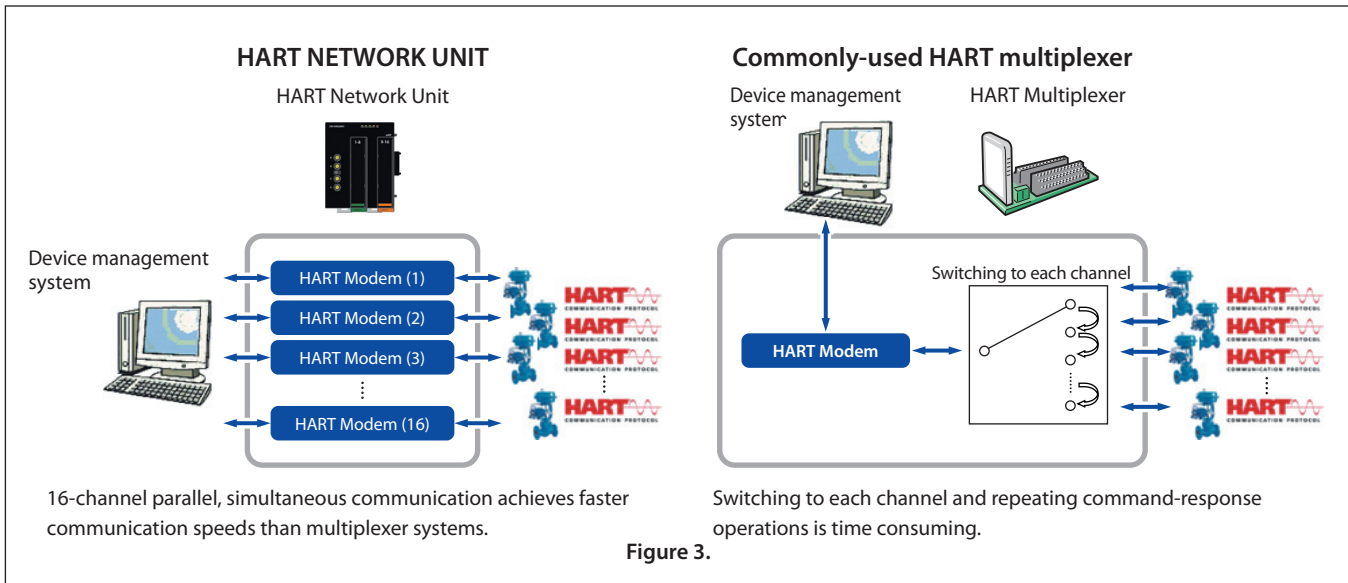

Individual Isolation between Channels

The HNU is combined with Signal Unit I/O-II to achieve individual isolation of DCS I/O module channels.

Flexible Mounting

Up to 16 HART devices can be connected to one HNU. Low-cost implementation with a small number of I/O points is made possible as both AI and AO can be provided by one HNU by means of individual wiring.

Compact, externally attachable, and compatible with DIN-rail mounting, the HNU can be flexibly installed into existing equipment. Flexible and scalable mounting for small to large installations is possible by using combined multiple HNUs or distributed HNUs connected by Ethernet.

Individual Isolation between Channels

Each channel and the channel to the power supply is isolated individually, that do not to affect the isolation of existing loops.

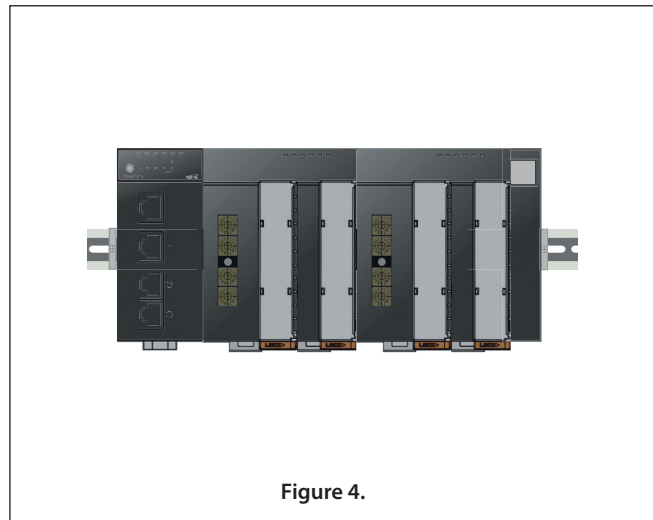

2. Product Configuration

The HNU is used in combination with the communication box (CB), communication adapter (CA), and terminal adapter (TA) of the Instrumentation Network Module NX.

The configuration can be selected from two possible combinations, front port ring configuration or side connector ring (horizontal connection) configuration, depending on the available installation space inside the cabinet or intended use.



* For more details on the Instrumentation Network Module NX, refer to the specification sheet (CP-SS-1865E).

2.1. Front Port Ring Configuration

In this configuration, the CA on each side of the HNU is connected by Ethernet to the respective front port of the CB. When the HNU and BU100H are in the same cabinet, select this configuration to enable common use of the CB. Up to 6 HNUs can be connected horizontally.

■ **Minimum Configuration**

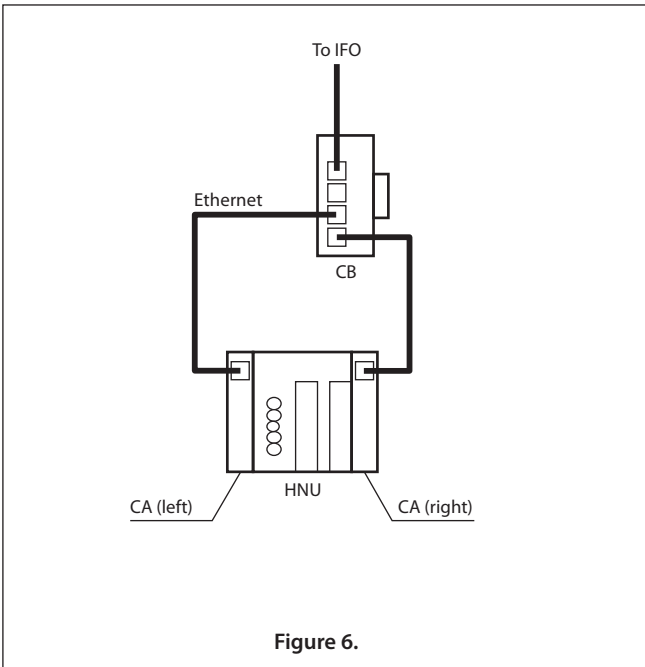

■ **Maximum Configuration**

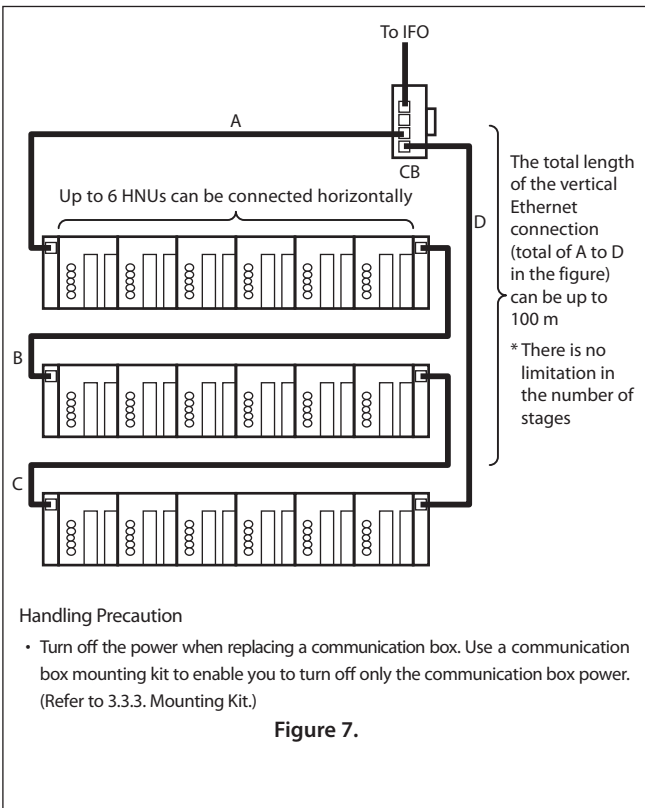

Handling Precaution

- Turn off the power when replacing a communication box. Use a communication box mounting kit to enable you to turn off only the communication box power. (Refer to 3.3.3. Mounting Kit.)

2.2. Side Connector Ring (Horizontal Connection) Configuration

In this configuration, the CB is connected to the left side of the HNU and the TA is connected to the right side. Up to 6 HNUs can be connected horizontally.

■ **Minimum Configuration**

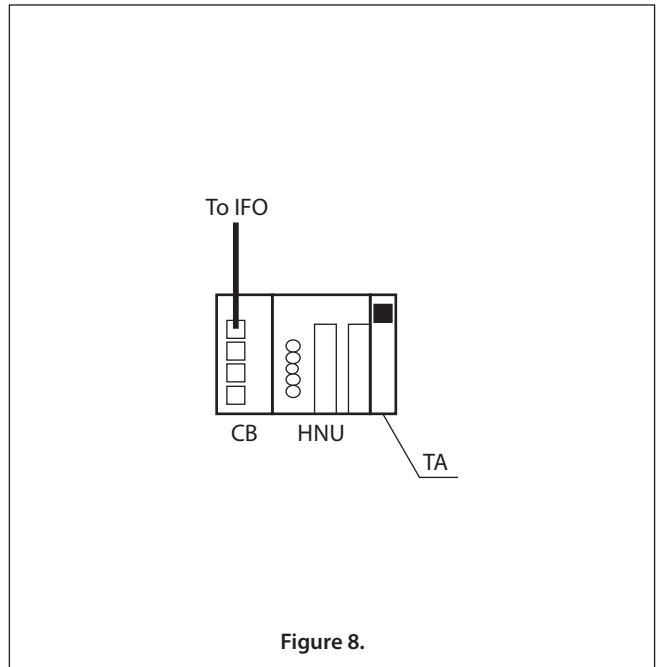

■ **Maximum Configuration**

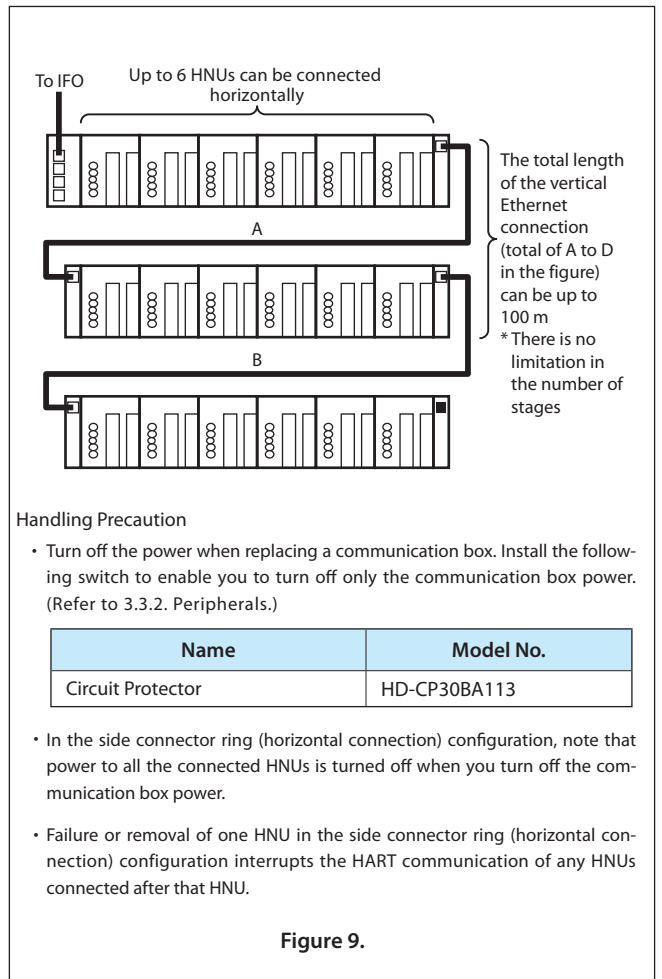

Handling Precaution

- Turn off the power when replacing a communication box. Install the following switch to enable you to turn off only the communication box power. (Refer to 3.3.2. Peripherals.)

Name	Model No.
Circuit Protector	HD-CP30BA113

- In the side connector ring (horizontal connection) configuration, note that power to all the connected HNUs is turned off when you turn off the communication box power.
- Failure or removal of one HNU in the side connector ring (horizontal connection) configuration interrupts the HART communication of any HNUs connected after that HNU.

3. Specifications

3.1. HART Network Unit (HNU) Specifications

Table 1.

	Item	Description
General specifications	Rated voltage	20.4 to 27.6 VDC
	Allowable operating voltage	21.6 to 26.4 VDC
	Maximum applicable voltage	30 VDC
	Power consumption	100 mA (for 24 VDC input)
	Inrush current at power-on	500 mA max.
	Insulation resistance	Between power supply and slots: 100 MΩ min. (500 VDC)
		Between each slot: 100 MΩ min. (500 VDC)
	Withstand voltage	Between power supply and slots: 500 VAC with leak current per minute of 1 mA or less
		Between each slot: 500 VAC with leak current per minute of 1 mA or less
	DC impedance between slot's +/- terminals	Power on: 20 MΩ or higher
		Power off: 20 MΩ or higher
	Dimensions	80 mm (W) x 134 mm (D) x 105 mm (H)
	Mass	469 g
Mounting method	DIN rail	
Built-in clock accuracy	Variance of -4 to +3 sec/day	
Standards compliance	None	
Operating conditions	Ambient temperature	0 to 50°C (bottom side of the HNU when it is mounted)
	Ambient humidity	10 to 90% RH (without condensation)
	Vibration	0 to 3.2 m/s ² (10 to 150 Hz for 2h each in x, y, and z directions)
	Shock	0 to 9.8 m/s ²
	Mounting angle against reference plane	± 3°
	Dust	0.3 mg/m ³ max.
	Corrosive gas	Make sure there is no corrosive gas
	Altitude	2000 m max.
	Pollution degree	2 (equivalent to normal office environment)
Transport and storage conditions	Ambient temperature	-20 to +70°C
	Ambient humidity	5 to 95% RH (without condensation)
	Vibration	0 to 9.8 m/s ² (10 to 150 Hz for 2h each in x, y, and z directions)
	Shock	0 to 300 m/s ² (3 times in the vertical direction when DIN rail mounted)
User interface	Rotary switch	Four rotary switches on the front side set the last two bytes of the IP address (first two bytes are fixed as "192.168")
	Reset switch	Press the push switch on the front side for three seconds to reset
	Status display LED	Five LEDs on the front side: PWR (green), RUN (green), COM (green), NST (orange), and FAIL (green/red)
Ethernet communication	Compatible signal standards	Compliant with IEEE802.3u 100BASE-TX (FastEthernet)
	Transmission speed	100 Mbps (fixed)
	Transmission method	Full duplex (fixed)
	Pin mapping	MDI/MDI-X (auto negotiation)
	Connection	Side connector connection

Item		Description
HART communication	Number of connect signals	16
	Wiring method	Connect to the M3 terminal block
	Impedance when receiving	50 kΩ or higher in the HART signal frequency band
	Receiving carrier Detection level	When carrier is detected: signal amplitude is greater than 0.12 Vpp
		When carrier is not detected: signal amplitude is lower than 0.08 Vpp
	Transmission frequency	When outputting data "0": 2200 Hz ± 1%
		When outputting data "1": 1200 Hz ± 1%
	Max. load of transmission	750 Ω max.
	Transmission signal amplitude	400 mVpp to 600 mVpp at 500 Ω load
Cycle of communication with devices	Communication in approximately one second cycle is possible for concurrent periodic communication (HART Command 3) with 16 slave devices.	
Compliance with HART CT	Compliant with the HART Association's SPEC Rev. 7.2 (HCF_SPEC-013). However, the following specification items are not supported. <ul style="list-style-type: none"> HCF_SPEC-081 Rev. 8.2 and HCF_SPEC-127 Rev. 7.1 Cmd6 → Use not allowed with Multidrop HCF_SPEC-085 Rev. 1.2 → Not compliant with the HART Communication Bridge Device. 	

3.2. Instrumentation Network Module NX Specifications

For the Instrumentation Network Module NX specifications, refer to *CP-SS-1865E Network Instrumentation Module Communications box NX-CB1 Communications adapter NX-CL1/NX-CR1 Terminal adapter NX-TL1/NX-TR1*.

3.3. Model Numbers

The model numbers of the main unit, peripherals (Instrumentation Network Module NX), and mounting kits comprising the HART Network Unit are as follows.

3.3.1. HART Network Unit (HNU)

Table 2. HART Network Unit (HNU)

Name	Model No.	Note
HART Network Unit	HD-HNU001	Standard unit
	HD-HNU001C	Varnished unit

3.3.2. Peripherals (Instrumentation Network Module NX)

Table 3. Peripherals (Instrumentation Network Module NX)

Name	Model No.	Note
Communication Box (with front-side ring and no side ring)	HD-CB1NR0400	
	HD-CB1NR040K	Varnished unit
Communication Box (with front-side ring and side ring)	NX-CB1RR0400	
	NX-CB1RR040K	Varnished unit
Communication Adapter (left)	NX-CL1000000	
	NX-CL100000K	Varnished unit
Communication Adapter (right)	NX-CR1000000	
	NX-CR100000K	Varnished unit
Terminal Adapter (right)	NX-TR1000000	
	NX-TR100000K	Varnished unit
Circuit Protector	HD-CP30BA113	Communication box power switch (Mitsubishi Electric)

3.3.3. Mounting Kits

Table 4. Mounting Kits

Name	Model No.	Note
HNU Standard Mounting Kit	HD-HNUKIT001	For Signal Unit I/O-II
HNU Vertical DIN Rail Mounting Kit	HD-HNUKIT002	For distributed I/O
Communication Box Mounting Kit*	HD-CBKIT001	For ERG cabinets
	HD-CBKIT002	For ERP Basic cabinets
	HD-CBKIT003	For ERP Advance cabinets

* This kit is used for attaching a communication box to a cabinet. Both the Circuit Protector (HD-CP30BA113) and a power cable for supplying power from the PDU are included in the kit.

3.4. External Dimensions

3.4.1. HART Network Unit (HNU)

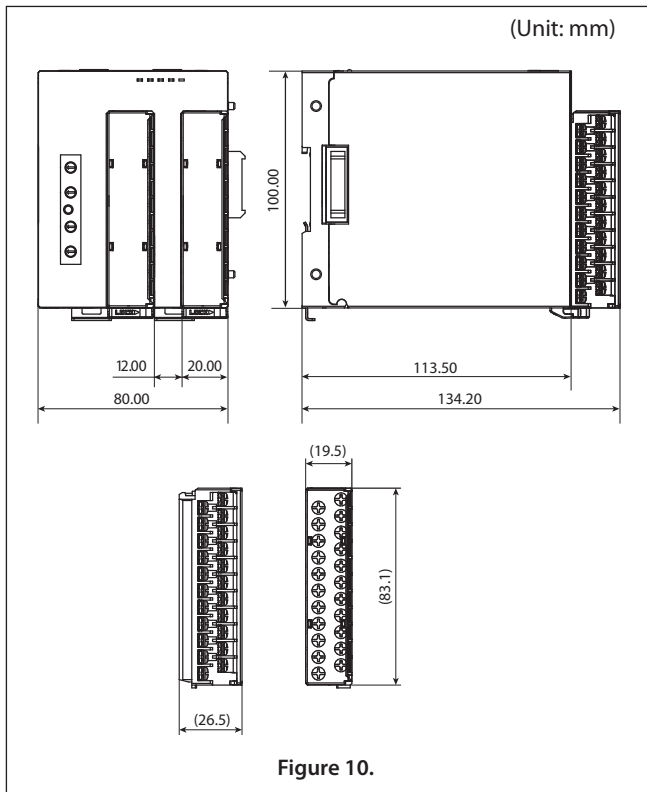

3.4.2. Peripherals (Instrumentation Network Module NX)

3.4.2.1. Communication Box

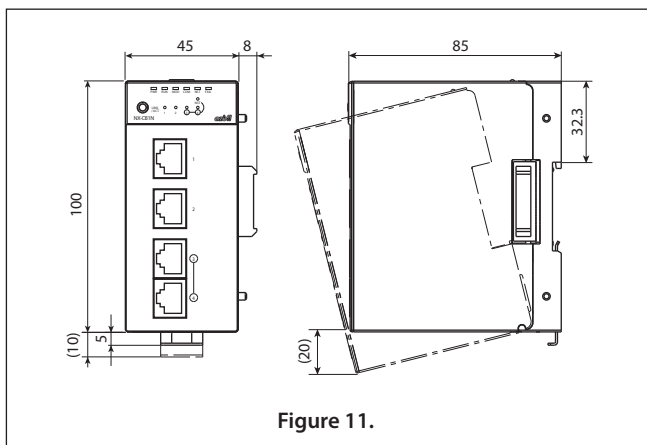

3.4.2.2. Communication Adapter

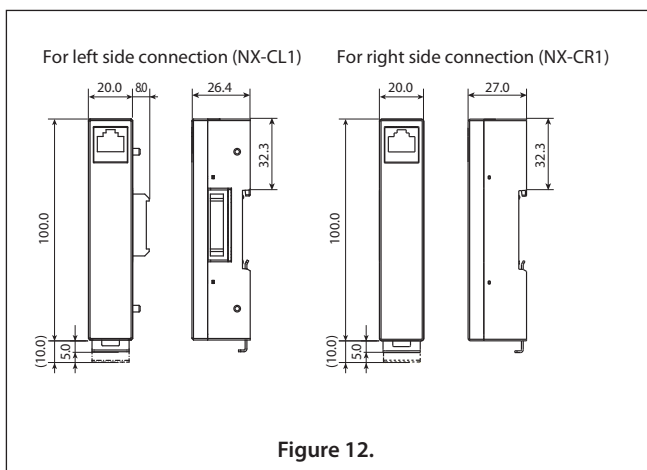

3.4.2.3. Terminal Adapter

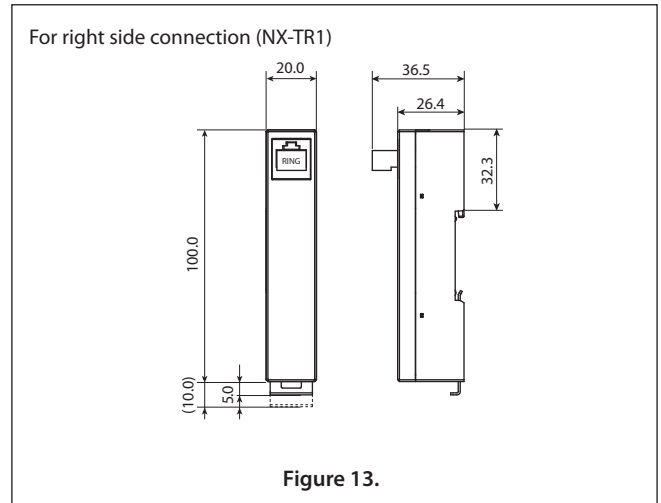

3.4.3. Mounting Kits

3.4.3.1. Standard Mounting Kit

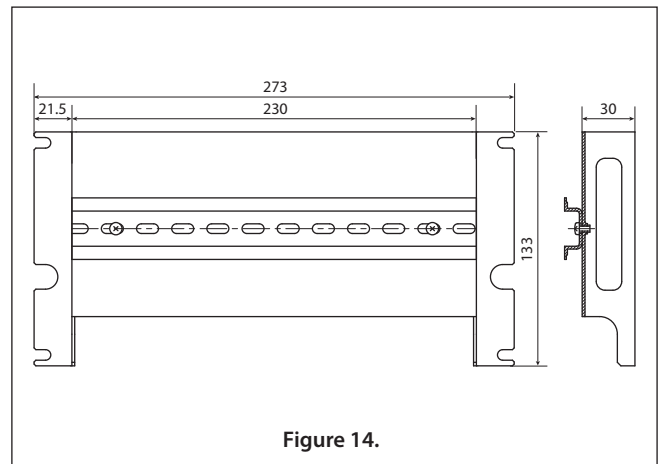

3.4.3.2. HNU Vertical DIN Rail Mounting Kit

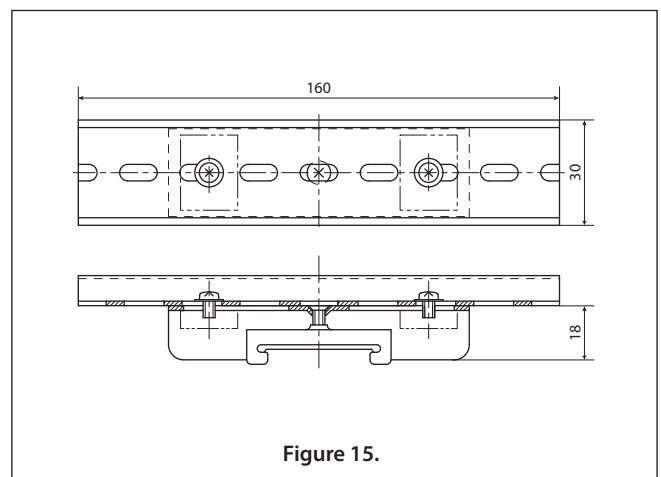

3.4.3.3. Communication Box Mounting Kit

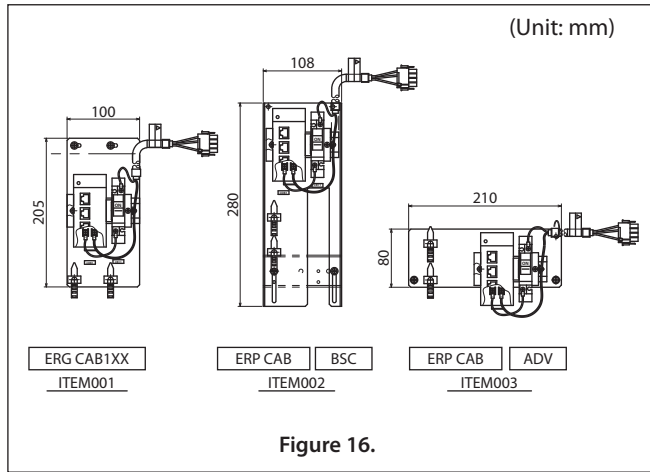

Figure 16.

3.5. Part Names

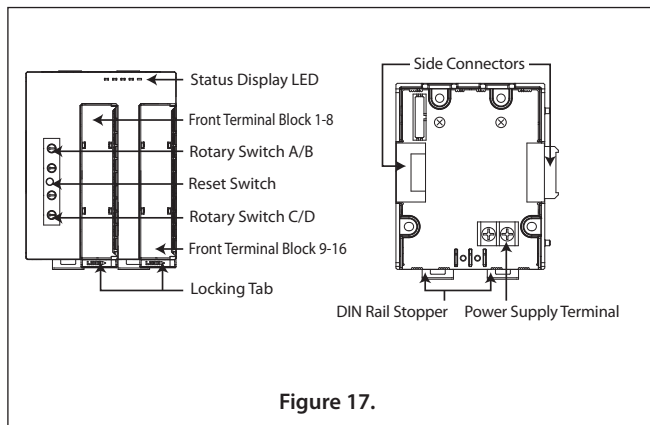

Figure 17.

3.5.1. Status Display LED

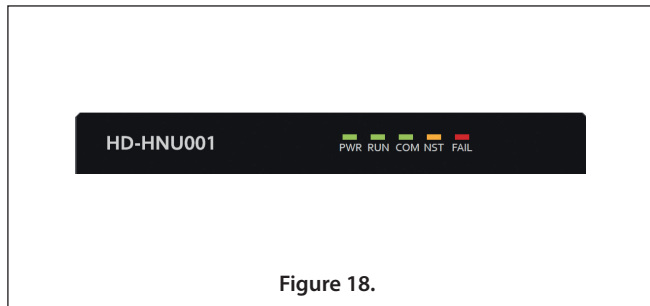

Figure 18.

The status of the HNU is indicated using the LED display.

Table 5.

LED name	Color	Lighting pattern	Description
PWR	Green	On	Power is turned on
		Off	Power is turned off
RUN	Green	On	In operation
		Flashing fast	Pressing down the Reset switch
		Flashing slowly	Updating the firmware
		Off	Stopped
COM	Green	On	Sending/receiving Ethernet packets for the relevant station
		Off	Ethernet packets for the relevant station are not being sent/received
NST	Orange	Flashing fast	Ring is disconnected (a part of the ring is disconnected)
		Flashing slowly	Ring is disconnected (the ring is disconnected from its own node or a neighboring node)
		Off	Ring in normal state
FAIL	Red/ Green	Red and green alternately	Setting error
		Red	Major failure
	Red	On	Major failure
		Flashing slowly	Minor failure
	Off	No problem	

3.5.2. Rotary Switch

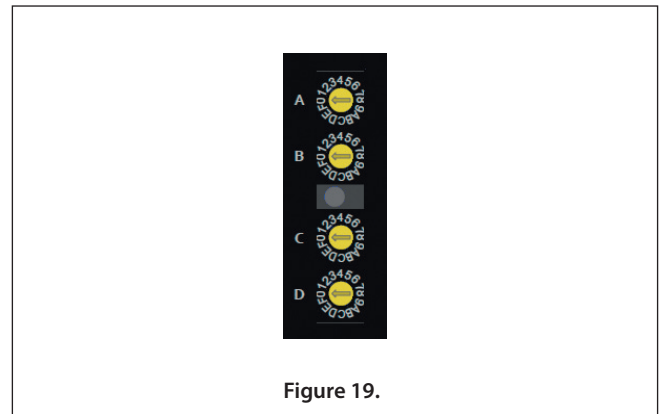

Figure 19.

These rotary switches are used to set the last two bytes of the IP address. The first two bytes are fixed as "192.168." The HNU's subnet mask is fixed as "255.255.255.0" and there is no default gateway (0.0.0.0).

- Rotary switch A/B
Set the last byte of the network address part in the HNU's IP address.
The range is from "0" "1" to "F" "E."
- Rotary switch C/D
Set the host address part in the HNU's IP address.
The range is from "0" "1" to "F" "E."

3.5.3. Reset Switch

This switch is used to reset the HNU. While the HNU is turned on, press this switch for three seconds to reset the HNU.

3.5.4. Front Terminal Block

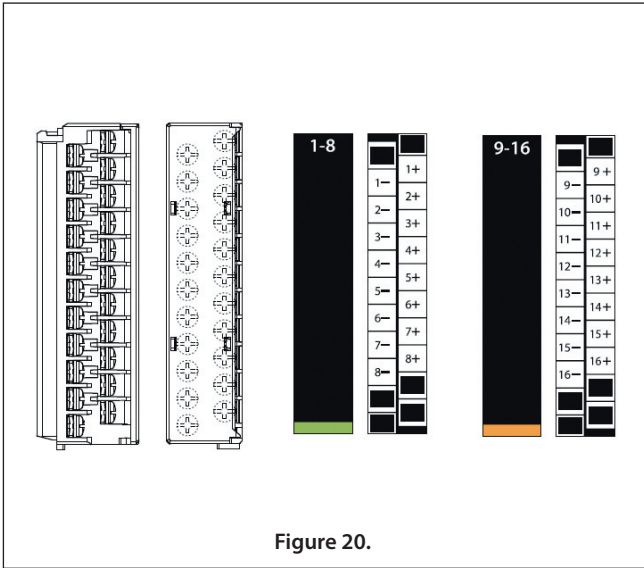

Figure 20.

This is a screw terminal block (M3) for connecting to the AI/O module.

The left side in the figure is the terminal block for slot 1 to slot 8. The right side is the terminal block for slot 9 to slot 16.

3.5.5. Power Supply Terminal

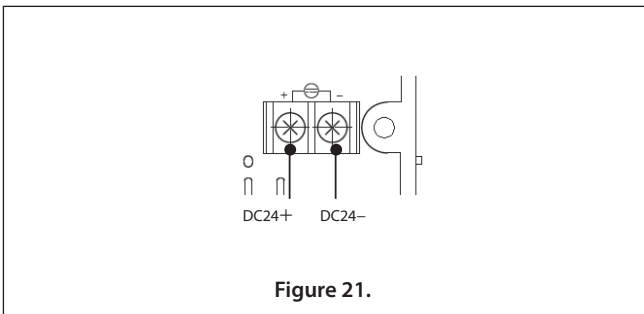

Figure 21.

This is a screw terminal block (M3.5) for the 24 VDC power supply.

3.5.6. Side Connectors

These are connectors for connecting other modules.

3.5.7. DIN Rail Stopper

This is a bracket to secure the unit on the DIN rail.

3.5.8. Locking Tab

This is a tab for securing the front terminal block.

4. Precautions and Restrictions

4.1. Sales in the United States

In order to avoid the possible infringement of third-party patents, the sale of this product involving a final delivery destination in the United States is prohibited.

4.2. Restrictions Regarding HART Communication

The HNU is compliant with SPEC Rev. 7.2 (HCF_SPEC-013) of the HART Association, but there are some precautions and restrictions regarding its use.

4.2.1. Precautions Regarding Multidrop

The HNU does not support Multidrop* as defined in the following specification.

* A method for connecting up to five field devices on the field wiring, by fixing the analog current and using HART communications only

Related specifications	HCF_SPEC-081 Rev. 8.2
	HCF_SPEC-127 Rev. 7.1 Cmd6

4.3. Precautions Regarding Connecting Devices

The following precautions should be taken regarding:

- HART devices connected with the HNU;
- isolators between the HNU and HART devices;
- field wiring between the HNU and HART devices; and
- DCS I/O modules.

4.3.1. HART Devices

The supported major HART revision is Rev. 5 or higher. This does not mean connections with all HART devices with Rev. 5 or higher are guaranteed. Please contact us if connect devices that are not confirmed to be compatible after referring to the "Devices Tested for Interoperability" section on the "HART/Fieldbus Solutions" page of our website.

4.3.2. Isolators

Be sure to use the isolators listed in the following table when connecting isolators between the HNU and HART devices. Isolators other than those listed in the table are not supported. Contact us if you wish to connect an isolators that is not listed in the table.

Table 6.

Manufacturer	Model No.	Type
Cooper Industries Japan K.K.	MTL5046	AO
PEPPERL & FUCHS	KFD2-SCD2	AO
M-System Co., Ltd.	M2DYH-□□	AO/AI
Cooper Industries Japan K.K.	MTL5042	AI
PEPPERL & FUCHS	KFD2-STC4	AI

4.3.3. Restrictions When Using Field Wiring

For field wiring, use cable with the specifications recommended in the physical layer standards issued by the HART Association. When using coaxial cables (parallel wire) or unshielded cables, depending on cable length and capacity, various types of environmental noise and cross-talk may affect transmission quality. Please refer to the "Field Cable Selection Guidelines" section and check in advance which cables can be used.

Table 7.

Item	Single	Multiple
Type	Shielded twisted pair	Shielded twisted pair (individually shielded cable is recommended)
Insulating material	Polyethylene	Polyethylene
Cable length	Up to 1500 m	Up to 1500 m
Cable diameter	0.51 mm (#24 AWG) or wider	0.51 mm (#24 AWG) or wider

Field Cable Selection Guidelines - Multiple Cables

If you cannot use a cable with the specifications recommended in the physical layer standards issued by the HART Association, check the type of multi cables in the table below and make sure the cable does not exceed the maximum length allowed.

Table 8.

Type	Name	Insulation coating material	Nominal cross-sectional area (mm ²)	Maximum cable length (m)
Twisted	Polyvinyl chloride insulated cable (equivalent to CV*)	Polyvinyl	0.9	721
			1.25	691
			2	626
	Polyethylene insulated cable (equivalent to CE*)	Polyethylene	0.9	1500
			1.25	1500
			2	1500
Coaxial (parallel)	Polyvinyl chloride insulated cable (equivalent to CV*)	Polyvinyl	0.9	433
			1.25	415
			2	375
	Polyethylene insulated cable (equivalent to CE*)	Polyethylene	0.9	1223
			1.25	1172
			2	1061

Field Cable Selection Guidelines - Single Cables

Please use the cable described below for single cables.

- Shielded twisted pair
- Insulation coating material of polyethylene (recommended)
- 1500 m or less

Note 1: The maximum cable length specified is only a guideline and does not guarantee communication status. Regardless of whether or not the cable length exceeds the maximum allowable length, noise in the surrounding environment of the field and other factors may affect transmission.

Note 2: The maximum cable length is the total cable length from the I/O module to the HART device.

Note 3: The maximum allowable cable length may be shorter if there is large capacity between the analog signal line inside the HART device and ground.

Note 4: Make sure that the cable length is within the maximum allowable length defined for the HART devices.

4.3.4. DCS I/O Module

- Precautions Regarding Effects on HART Communication
Some combinations with the I/O module may result in an increase in HART communication errors caused by the following problems. If you intend to connect with an I/O module other than our DCS, contact us concerning whether the module can be connected or not.
Some modules may require the introduction of a HART filter.

- The noise generated by the AO circuit interferes with the HART signal's frequency bandwidth.
- The I/O module's impedance in the HART frequency bandwidth (500 Hz to 10 kHz) is lower than 230 Ω.

- Precautions Regarding Effects on 4-20 mA Current Loops
Some AO modules may be affected by the HART signal and output may fluctuate. If you intend to connect with an I/O module other than our DCS, contact us concerning whether the module can be connected or not. Some modules may require the introduction of a HART filter.

4.3.5. Precautions Regarding Connection of HART Communicators

In a combination of IFO, HNU and HART devices, the communication cycle setting (for example, of one second) cannot be followed if a HART communicator is connected during periodic communication. In addition, because there are two masters, the response time of communication with the HART communicator and other devices will deteriorate. When connecting the HART communicator, do so after stopping the periodic communication on the IFO.

4.4. Restrictions When Connecting HART Communication-compliant Field Devices

4.4.1. Precautions Regarding Connection of Analog Output and HART Devices

To maintain communication between the HNU and HART devices, make sure that the output current from analog output devices does not go lower than the minimum drive current of the HART devices connected.

For example, if you are connecting to any of the HART devices in the table below, the output current setting for analog output devices should be no lower than -0.5% (output current: 3.85 mA). Otherwise, the output current falls below the minimum drive current, and HART communication can no longer be used.

Table 9.

Product model number	Minimum drive current
AVP302, AVP202, and SVX102	3.85 mA

- HART® is a trademark of HART Communication Foundation.
- Other product names, model nos., and company names may be trademarks of the respective company.

Please read the "Terms and Conditions" from the following URL before ordering or use:

<http://www.azbil.com/products/bi/order.html>

Specifications are subject to change without notice.

The logo for Azbil Corporation, featuring the word "azbil" in a bold, lowercase, sans-serif font.

Azbil Corporation
Advanced Automation Company

1-12-2 Kawana, Fujisawa
Kanagawa 251-8522 Japan
URL: <http://www.azbil.com/>

1st edition: Oct. 2013

No part of this publication may be reproduced or duplicated without the prior written permission of Azbil Corporation.