

3/2- and 4/2-multi-way valves ; servo-assisted;  
block assembly or NAMUR flange; DN 4; flow rate: 300 l/min

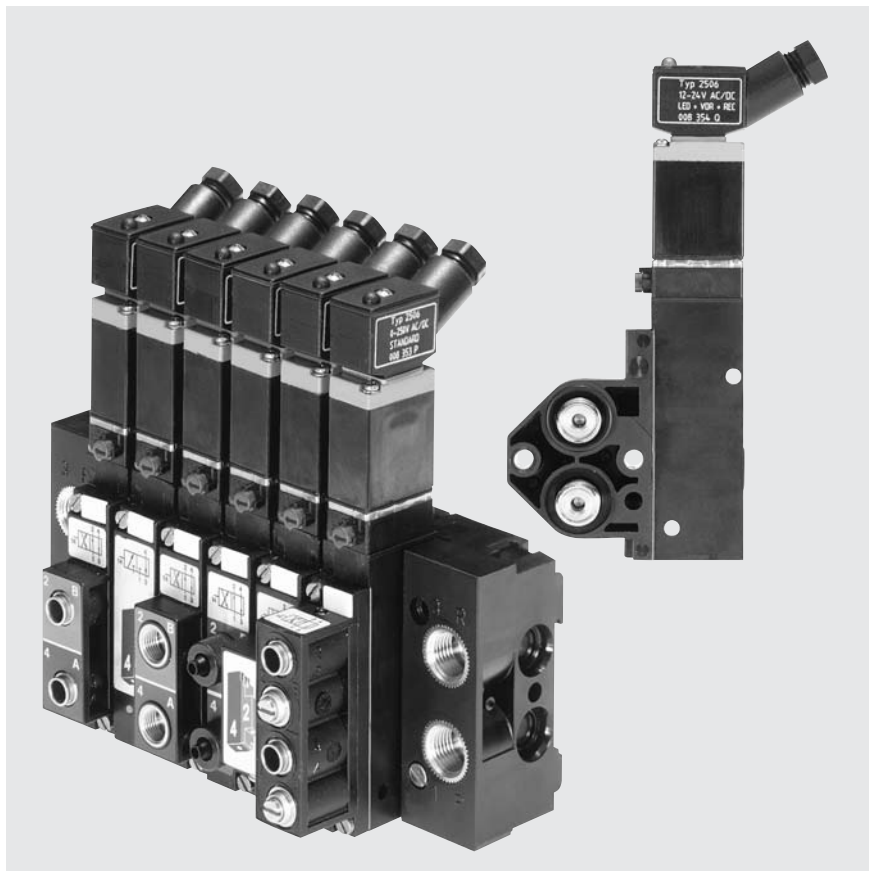

### Advantages / Benefits

- ▶ II 2G EEx ia IIC T6 PTB01 ATEX 2175 approved
- ▶ Available for block assembly and with NAMUR flange
- ▶ High flow rate at compact design
- ▶ Maintenance-free and no wear due to high level dry run properties
- ▶ With manual override
- ▶ Various options for the service ports 2 and 4
- ▶ High switch reliability
- ▶ Block assembly version fieldbus compatible
- ▶ Low weight

### Design/Function

Type 5470 EExi includes high switch reliable diaphragm seat valves as 3/2- and 4/2-way version. The valve consists of three modules, valve body with servo-diaphragm, plungers and seat seals as well as numerous connection possibilities for the service ports 2 and 4.

The body and valve internal parts are made of high quality thermoplastic, the return spring is made of stainless steel.

A 16 mm rocker solenoid valve type 6106 with rectifier and an EExi coil is used as pilot.

Tag connectors are used as electrical contact (acc. to DIN 43 650 Form C) with cable plug type 2506.

The extendable type 5470 EExi can be used for block modules or for entire valve blocks (tag connectors on top, coil spacing 19 mm).

The block assembly is made with pneumatic modules type MP05 through integrated lock technology and screwing.

Type 5470 NAMUR EExi can be easily mounted to a process valve with the same interface.



### Applications

**Applications:**

- Chemical industry
- Pharmaceutical processing equipment
- Industrial waster water treatment
- Oil and gas industry

**burkert**  
Fluid Control Systems

## Technical Data Type 5470 NAMUR Ex-Version

### Circuit functions

**C** 3/2-way valve,  
when de-energized,  
outlet port exhausted

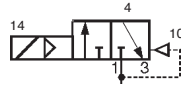

**G** 4/2-way valve,  
when de-energized,  
pressure inlet port 1 connected  
to outlet port 2,  
outlet port 4 exhausted

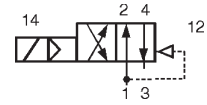

### Specifications

Circuit function	Orifice [mm]	Flow rate <sup>1)</sup> QNn-Value (air) [l/min]	Pressure range <sup>2)</sup> [bar]	Power consump. [W]	Response times		Port connections
					opening <sup>3)</sup> [ms]	closing <sup>3)</sup> [ms]	
C (3/2)	4.0	300	2 – 8	0.5	60	50	Supply port 1 & 3: plug-in coupling ø 6 mm in front or downwards Service port 2 & 4: sub-base or NAMUR flange
G (4/2)	4.0	300	2 – 8	0.5	60	50	Supply port 1 & 3: plug-in coupling ø 6 mm or threaded port G 1/8 Service port 2 & 4: sub-base or NAMUR flange

<sup>1)</sup> Measured with 6 bar upstream pressure and 1 bar pressure drop across the valve and at +20 °C.

<sup>2)</sup> All pressures quoted are gauge pressures with respect to the prevailing atmospheric pressure.

<sup>3)</sup> Measured at connection 2; time from electrical switching to pressure increase to 90 % (opening) or pressure drop to 10 % (closing) of operational pressure of 6 bar.

### Valve Specifications

Valve body	PA (Polyamide)
Valve internal parts	Ultramid
Return spring	Stainless steel
Seal material	NBR
Fluids	Lubricated, unlubricated compressed air, nitrogen, instrument air
Media temperature	-10 up to +50 °C
Ambient temperature	-10 up to +55 °C
Port connections	
NAMUR version:	
Connection 2 and 4	• NAMUR flange
Connection 1 and 3	• Plug-in coupling ø 6 mm • G 1/8 (variation)
Block assembly version:	
Connection 1 and 3	• Sub-base at the back
Connection 2 and 4	• G 1/8 in front • Plug-in coupling ø 6 mm below or in front • Screwed tube connector SL 6/4 mm, in front

### Solenoid Specifications

$U_i$	35 V
$I_i$	0.9 A
$P_i$	see manual
$I_{min}$	29 mA
$R_{i20°C}$	320 Ω
Duty cycle	100% continuously rated
Electr. connection	Tag connectors acc. to DIN 43650 Form C, for cable plug type 2506 (do not use connectors with LED or circuitry)
Rating	IP 65 (with cable plug)
Type of protection	II 2G EEx ia IIC T6 PTB01 ATEX 2175

### Electrical Specifications

See data sheet „Recommended Barriers“

### Installation

Mounting position: Any, preferably solenoid system upright

**Block and Wall Mounting with Pneumatic Modules Type MP05 [mm]**

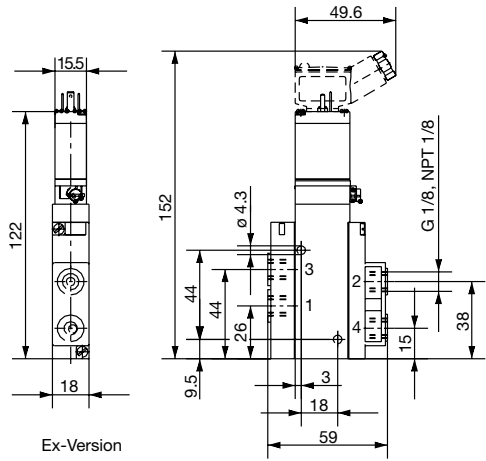

Ex-Version

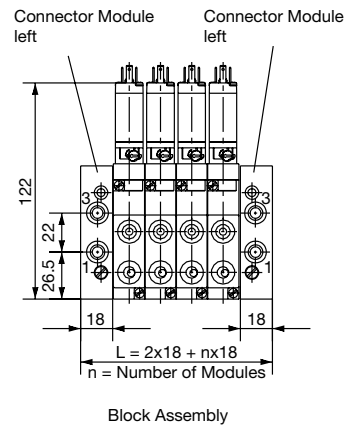

Block Assembly

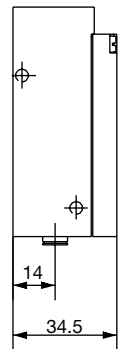

Plug-in coupling  $\varnothing$  6 mm below

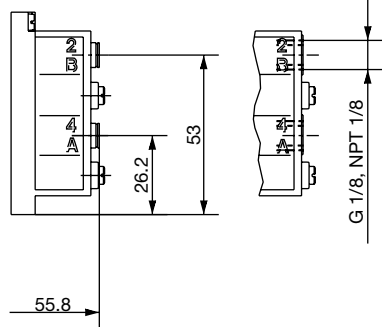

Plug-in coupling  $\varnothing$  6 mm and threaded port G 1/8 in front, with one-way flow restrictor

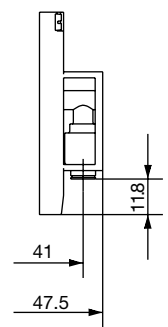

Plug-in coupling  $\varnothing$  6 mm below

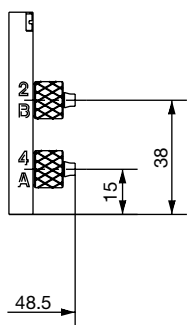

Screwed tube connector SL 6/4 mm in front

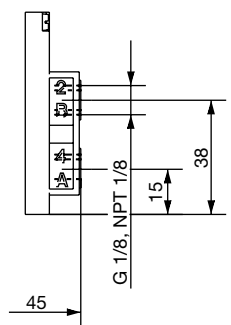

Threaded port G 1/8 in front

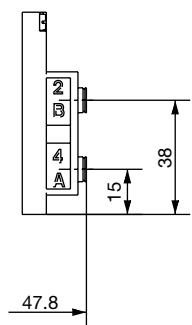

Plug-in coupling  $\varnothing$  6 mm in front

DTS 1000011025 EN Version: B Status: RL (released | freigegeben | validé) printed: 24.10.2016

NAMUR

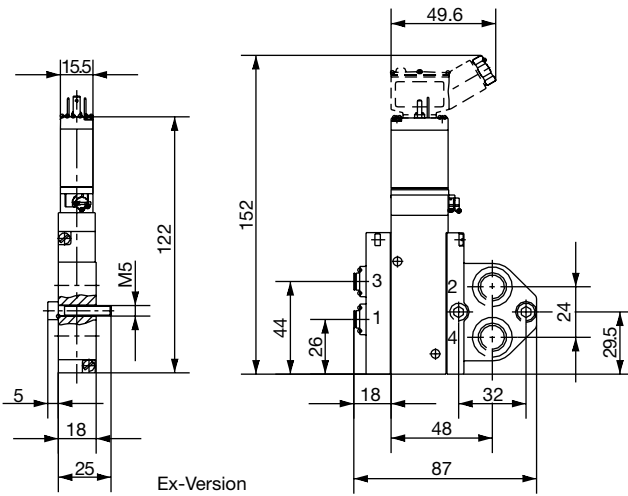

Block Assembly with Pneumatic Modules Type MP05, Coil Spacing 19 mm

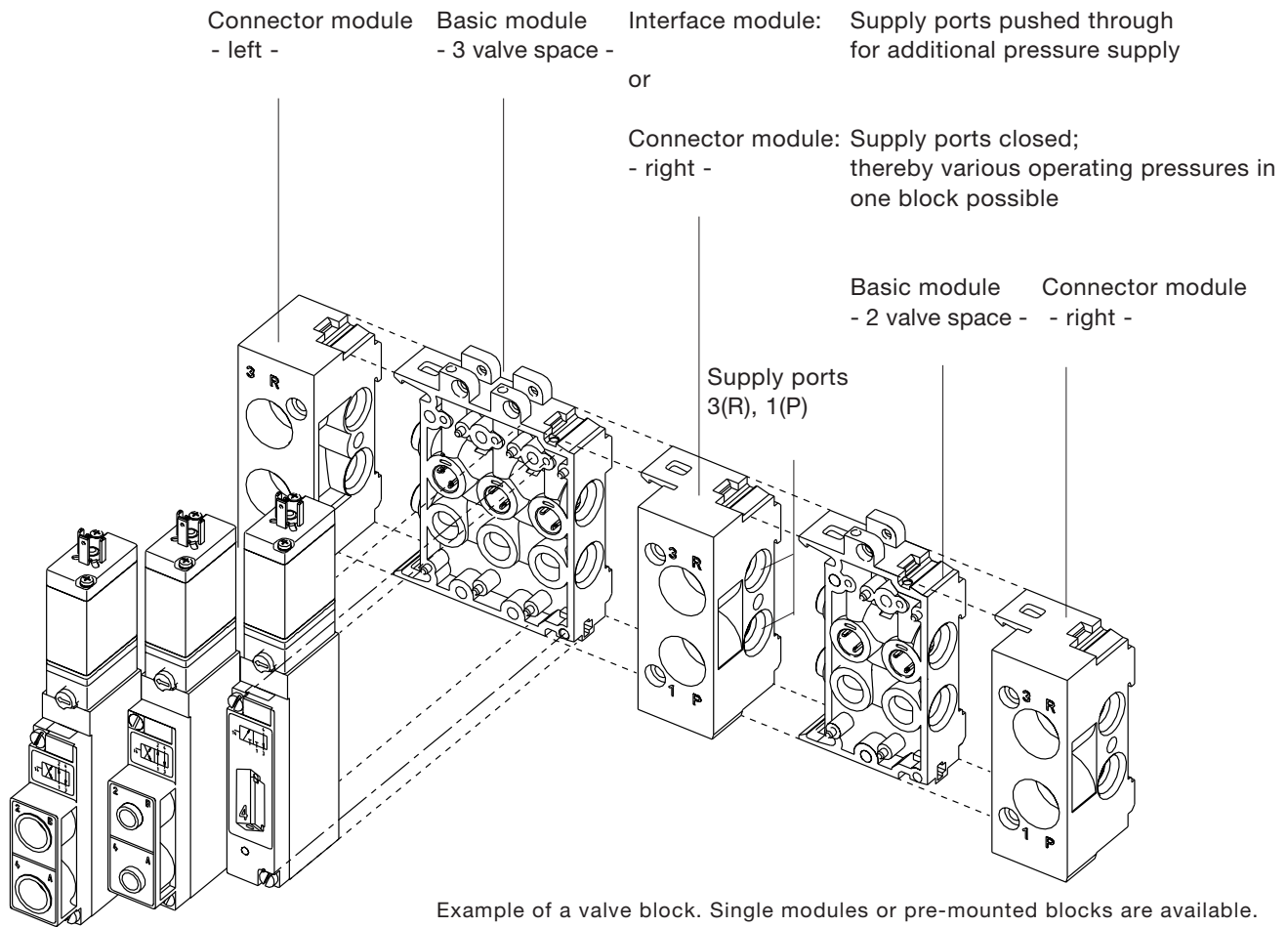

Example of a valve block. Single modules or pre-mounted blocks are available. When ordering, please inform on the individual modules and the desired configuration from right to left. For information on assembly of a valve block, please see data sheet Customized Pneumatic Systems Solutions.

**Ordering Chart Valves Type 5470 NAMUR (Other Versions on Request)**

**Scope of delivery:** All valves with manual override and with NBR seal; tag connectors on top acc. to DIN 43 650 C;  
**without cable plug** (see accessories)

**Block assembly versions**

Circuit function	Orifice [mm]	Flow rate QNn-Value (air) [l/min]	Supply port connection 1 and 3	Service port connection 2 and 4	Pressure range [bar]	Item-No.
C	4.0	300	Sub-base behind	Push-in connection ø 6 mm downwards	2 – 8	139 400 B
			Sub-base behind	Push-in connection ø 6 mm in front		139 401 Y
G	4.0	300	Sub-base behind	Push-in connection ø 6 mm downwards	2 – 8	139 403 S
			Sub-base behind	Push-in connection ø 6 mm in front		139 404 T
			Sub-base behind	G 1/8 in front	2 – 8	139 405 U
			Sub-base behind	Screwed tube connection SL 4/6 in front		139 406 V

**NAMUR versions**

Circuit function	Orifice [mm]	Flow rate QNn-Value (air) [l/min]	Supply port connection 1 and 3	Service port connection 2 and 4	Pressure range [bar]	Item-No.
C	4.0	300	G 1/8 in front	NAMUR flange	2 – 8	139 224 V
			Push-in connection in front	NAMUR flange		139 402 Z
G	4.0	300	G 1/8 in front	NAMUR flange with one-way flow restrictor	2 – 8	139 407 W
			Push-in connection in front	NAMUR flange with one-way flow restrictor		139 408 F

DTS 1000011025 EN Version: B Status: RL (released | freigegeben | validé) printed: 24.10.2016

**Ordering Chart Pneumatic Modules Type MP05**

Module version	Item-No.
Connector module left, G 1/8	133 175 N
Connector module left, G 1/4	132 512 F
Connector module right, G 1/8	133 177 Q
Connector module right, G 1/4	132 514 H
Basic module 2 valve space	132 516 B
Basic module 3 valve space	132 517 C
Basic module 2 valve space with 1-way flow restrictor	132 518 M
Basic module 3 valve space with 1-way flow restrictor	132 519 N

**Ordering Chart Accessories**

Accessory part	Characteristics	Item-No.
Cable plug type 2506 <sup>1)</sup>	without circuit, 0 - 250 V	008 353 P
Manifold G 1/8	Intermediate supply	643 019 C
Manifold NPT 1/8	Intermediate supply	643 028 D
Blanking screw	G 1/8	631 019 Y
Blanking screw	G 1/4	631 020 V
Blanking plug for plug-in coupling	ø 6 mm	015 397 J
Pressure rings for plug-in coupling	ø 6 mm	015 401 P
Covering plate (black)	for vacant valve spaces	643 223 D
Indicating tag	64 pieces	623 816 L

<sup>1)</sup> With these accessories, only a minimum of possible cable plugs with circuit are being mentioned. For other versions see data sheet type 2506.  
A flat seal and a fixing screw are part of the delivery scope of a cable plug.

**Dimensions Cable Plug Type 2506 [mm]**

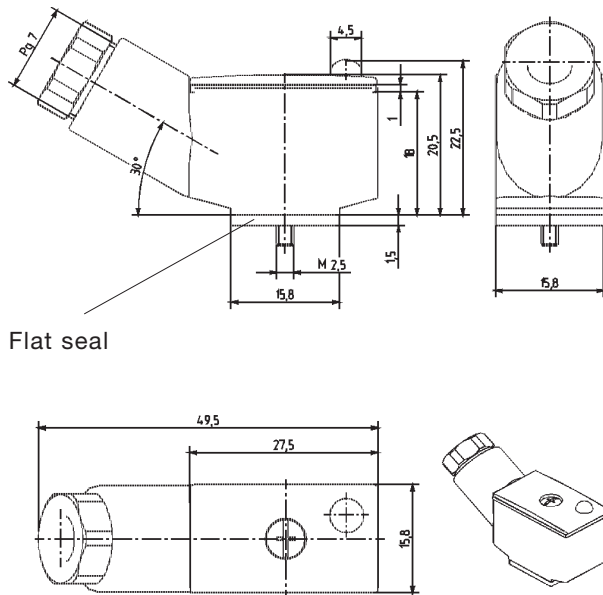

Cable plug type 2506 (pin assignment acc. to DIN 43650, Form C)

DTS 1000011025 EN Version: B Status: RL (released | freigegeben | valide) printed: 24.10.2016