



## Manually operated 2 and 3-way ball valves

- Various types of valve bodies
- Full bore
- Can also be supplied with DVGW approval

Manual ball valve in brass and stainless steel for shutting off and distributing medium flows.

### Versions







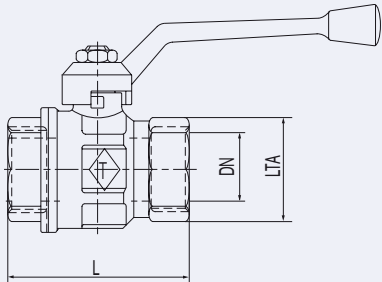

- Manual shut-off ball valve, full bore
- Ball valve DVGW approved
- Mini lux ball valve with rotary wing
- Ball valve with rotary wing, full bore
- 3-way ball valve with L or T bore
- Stainless steel ball valve

| Technical data                     |  |                 |
|------------------------------------|--|-----------------|
| <b>Orifice</b>                     | DN6 - DN100  |                 |
| <b>Body material</b>               | brass, nickel-plated   | stainless steel |
| <b>Ball material</b>               | brass, hard-chrome plated  | stainless steel |
| <b>Sealing material</b>            | PTFE   | PTFE            |
| <b>Pressure range<sup>1)</sup></b> | technical vacuum ( $10^{-3}$ Torr)<br>to nominal pressure PN (see Ordering charts) |                 |
| <b>Temperature range</b>           | see ordering charts  |                 |







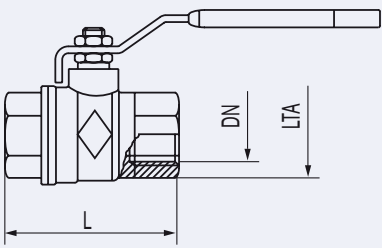

<sup>1)</sup> Pressure data [bar]: Overpressure with respect to atmospheric pressure

## Ordering charts 2- and 3-way ball valves, brass body





## Manual shut-off ball valve, full bore, Internal thread

| TKU004  | Materials   | Temperature range | DN [mm] | LTA | L [mm] | K <sub>v</sub> value [m <sup>3</sup> /h] | PN (80 °C) [bar] | Article no.  |
|---|---|-------------------|---------|-----|--------|--|------------------|--|
|   |   |                   |         |     |        |  |                  |  |
|  | Body: brass, nickel-plated<br>Ball: brass, hard-chrome plated<br>Seal: PTFE<br>Lever: aluminium, plastic coated | -20 °C to +160 °C | 8       | ¼   | 51.5   | 5.4                                      | 64               | 780230  |
|   |   |                   | 10      | ¾   | 51.5   | 6.0                                      | 64               | 780231  |
|   |   |                   | 15      | ½   | 55.0   | 16.3                                     | 30               | 780232  |
|   |   |                   | 20      | ¾   | 57.0   | 29.5                                     | 30               | 780233  |
|   |   |                   | 25      | 1   | 69.5   | 43.0                                     | 30               | 780234  |
|   |   |                   | 32      | 1¼  | 81.5   | 89                                       | 25               | 781746  |
|   |   |                   | 40      | 1½  | 95     | 230                                      | 25               | 781747  |
|   |   |                   | 50      | 2   | 113    | 265                                      | 25               | 781748  |

## Ball valve, DVGW approval (DIN DVGW-NG-4312BU0103), full bore

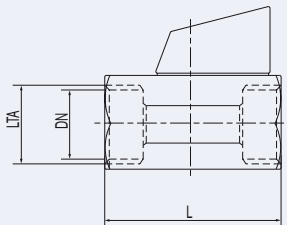
| TKU004   | Materials  | Temperature range | DN [mm] | LTA | L [mm] | K <sub>v</sub> value [m <sup>3</sup> /h] | PN [bar] | Article no.  |
|--|--|-------------------|---------|-----|--------|--|----------|--|
|  |  |                   |         |     |        |  |          |  |
|  | Body: brass, nickel-plated<br>Ball: brass, hard-chrome plated<br>Seal: PTFE<br>Lever: aluminium, anodised, yellow coated | -20 °C to +60 °C  | 10      | ¼   | 47.5   | 5.4                                      | 5        | 773239  |
|  |  |                   | 10      | ¾   | 49.5   | 6  | 5        | 773240  |
|  |  |                   | 15      | ½   | 65.0   | 16.3                                     | 5        | 773241  |
|  |  |                   | 20      | ¾   | 73.5   | 29.5                                     | 5        | 773242  |
|  |  |                   | 25      | 1   | 86.5   | 43                                       | 5        | 773243  |
|  |  |                   | 32      | 1¼  | 101.5  | 89                                       | 5        | 773244  |
|  |  |                   | 40      | 1½  | 111.5  | 230                                      | 5        | 773245  |
|  |  |                   | 50      | 2   | 132.5  | 265                                      | 5        | 773246  |

## Mini lux ball valve with rotary wing, Internal thread

| TKU004  | Materials   | Temperature range | DN [mm] | LTA | L [mm] | K <sub>v</sub> value [m <sup>3</sup> /h] | PN [bar] | Article no.  |
|---|---|-------------------|---------|-----|--------|--|----------|--|
|   |   |                   |         |     |        |  |          |  |
|  | Body: brass, nickel-plated<br>Ball: brass, hard-chrome plated<br>Seal: PTFE | -20 °C to +90 °C  | 6       | ⅛   | 41     | 4.3                                      | 10       | 781653  |
|   |   |                   | 8       | ¼   | 41     | 4.3                                      | 10       | 781654  |
|   |   |                   | 10      | ¾   | 41     | 4.3                                      | 10       | 781655  |
|   |   |                   | 15      | ½   | 46     | 4.3                                      | 10       | 781656  |

Ordering charts 2- and 3-way ball valves, brass body, cont.

Mini lux ball valve with rotary wing, Internal and external thread

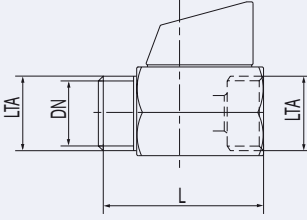
| TKU004  | Materials   | Temperature range      |         |     |        |  |          | Article no. |
|---|---|------------------------|---------|-----|--------|--|----------|-------------|
|   |   |                        | DN [mm] | LTA | L [mm] | K <sub>v</sub> value [m <sup>3</sup> /h] | PN [bar] |             |
|  | Body: brass, nickel-plated<br>Ball: brass, hard-chrome plated<br>Seal: PTFE | -20 °C<br>to<br>+90 °C | 8       | 1/8 | 41     | 4.3                                      | 10       | 781657      |
|   |   |                        | 8       | 1/4 | 41     | 4.3                                      | 10       | 781658      |
|   |   |                        | 10      | 3/8 | 41     | 2.7                                      | 10       | 781659      |
|   |   |                        | 15      | 1/2 | 46     | 5.4                                      | 10       | 781660      |

Ball valve with rotary wing, full bore, Internal thread

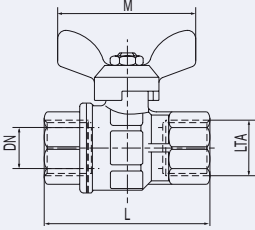
| TKU004  | Materials   | Temperature range       |         |     |        |        |  | Article no. |          |
|---|---|-------------------------|---------|-----|--------|--------|--|-------------|----------|
|   |   |                         | DN [mm] | LTA | L [mm] | M [mm] | K <sub>v</sub> value [m <sup>3</sup> /h] |             | PN [bar] |
|  | Body: brass, nickel-plated<br>Ball: brass, hard-chrome plated<br>Seal: PTFE<br>Lever: aluminium | -20 °C<br>to<br>+160 °C | 8       | 1/4 | 51.5   | 50     | 5.4                                      | 64          | 781752   |
|   |   |                         | 10      | 3/8 | 51.5   | 50     | 6.0                                      | 64          | 781753   |
|   |   |                         | 15      | 1/2 | 55     | 50     | 16.3                                     | 30          | 781754   |
|   |   |                         | 20      | 3/4 | 57.5   | 64     | 29.5                                     | 30          | 781755   |
|   |   |                         | 25      | 1   | 69.5   | 94     | 43                                       | 30          | 781756   |

3-way Ball valve with L or T bore, full bore

Switch positions  
T-bore

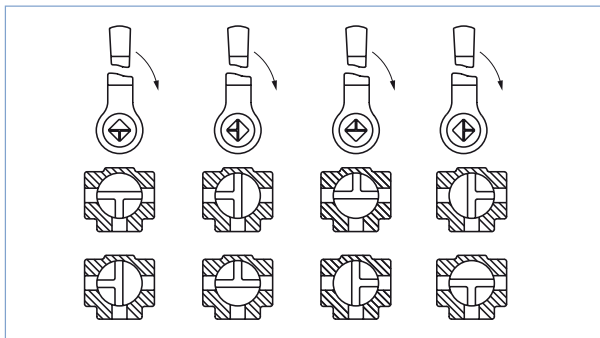



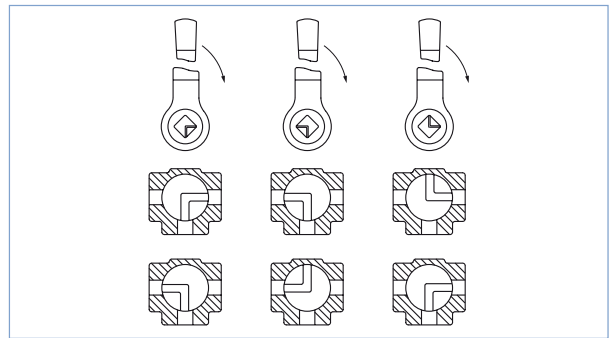

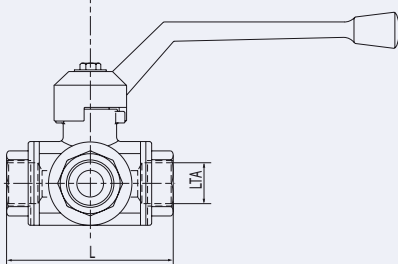

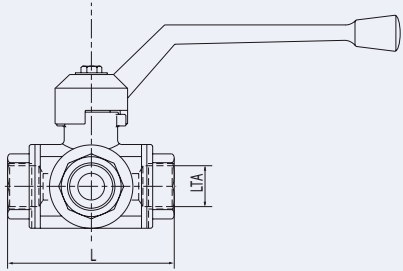

Switch positions  
L-bore



| TKU004  | Materials   | Temperature range       |         |        |        |  |          | Article no.<br>L bore |
|---|---|-------------------------|---------|--------|--------|--|----------|-----------------------|
|   |   |                         | DN [mm] | LTA    | L [mm] | K <sub>v</sub> value [m <sup>3</sup> /h] | PN [bar] |                       |
|  | Body: brass, nickel-plated<br>Ball: brass, hard-chrome plated<br>Seal: PTFE<br>Lever: aluminium | -20 °C<br>to<br>+160 °C | 8       | 1/4"   | 80.5   | 2.8                                      | 40       | 781762                |
|   |   |                         | 10      | 3/8"   | 80.5   | 3  | 40       | 781763                |
|   |   |                         | 15      | 1/2"   | 80.5   | 3.6                                      | 40       | 781764                |
|   |   |                         | 20      | 3/4"   | 93.4   | 6  | 40       | 781765                |
|   |   |                         | 25      | 1"     | 107.3  | 11                                       | 25       | 781766                |
|   |   |                         | 32      | 1 1/4" | 118    | 16                                       | 16       | 781767                |
|   |   |                         | 40      | 1 1/2" | 141    | 25.5                                     | 16       | 781768                |
| 50  | 2"  | 169                     | 37.5    | 16     | 781769 |  |          |                       |

## Ordering charts 2- and 3-way ball valve, brass body, cont.

| TKU004<br> | Materials   | Temperature range       | DN [mm] | LTA | L [mm] | K <sub>v</sub> value [m <sup>3</sup> /h] | PN [bar] | Article no.  |
|---|---|-------------------------|---------|-----|--------|--|----------|--|
|   |   |                         |         |     |        |  |          | T bore   |
|   | Body: brass, nickel-plated<br>Ball: brass, hard-chrome plated<br>Seal: PTFE<br>Lever: aluminium | -20 °C<br>to<br>+160 °C | 8       | ¼"  | 80.5   | 3  | 40       | 781770  |
|   |   |                         | 10      | ⅜"  | 80.5   | 3.5                                      | 40       | 781771  |
|   |   |                         | 15      | ½"  | 80.5   | 4.3                                      | 40       | 781772  |
|   |   |                         | 20      | ¾"  | 93.4   | 6.6                                      | 40       | 781773  |
|   |   |                         | 25      | 1"  | 107.3  | 12.2                                     | 25       | 781774  |
|   |   |                         | 32      | 1¼" | 118    | 16.9                                     | 16       | 781775  |
|   |   |                         | 40      | 1½" | 141    | 26.3                                     | 16       | 781776  |
|   |   |                         | 50      | 2"  | 169    | 38.2                                     | 16       | 781777  |

Ordering charts 2- and 3-way ball valves, stainless steel body

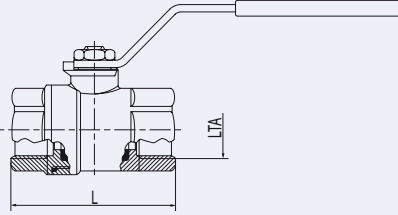
| TKU004  | Materials                                  | Temperature range       | DN [mm] | LTA | L [mm] | K <sub>v</sub> value [m <sup>3</sup> /h] | PN (80 °C) [bar] | Article no.              |
|---|--|-------------------------|---------|-----|--------|--|------------------|--------------------------|
|   |  |                         |         |     |        |  |                  |                          |
|  | Body:<br>stainless steel<br>AISI 351-CF 8M | -20 °C<br>to<br>+160 °C | 8       | ¼"  | 53.5   | 5.4                                      | 64               | 781824 <a href="#">↗</a> |
|   |  |                         | 10      | ⅜"  | 53.5   | 6  | 64               | 781825 <a href="#">↗</a> |
|   | Ball:<br>Stainless steel<br>AISI 351       |                         | 15      | ½"  | 60     | 16.3                                     | 64               | 781826 <a href="#">↗</a> |
|   |  |                         | 20      | ¾"  | 70     | 29.5                                     | 40               | 781827 <a href="#">↗</a> |
|   | Seal: PTFE                                 |                         | 25      | 1"  | 79     | 43                                       | 40               | 781828 <a href="#">↗</a> |
|   | O Ring: FKM                                |                         | 32      | 1¼" | 91     | 89                                       | 25               | 781829 <a href="#">↗</a> |
|   | Lever: stainless steel<br>AISI 430         |                         | 40      | 1½" | 103    | 230                                      | 25               | 781830 <a href="#">↗</a> |
|   |  |                         | 50      | 2"  | 124    | 265                                      | 25               | 781831 <a href="#">↗</a> |

3-way ball valve with L or T bore, reduced flow with flange mounting, ISO 5211 and hand lever

Switch positions  
T-bore

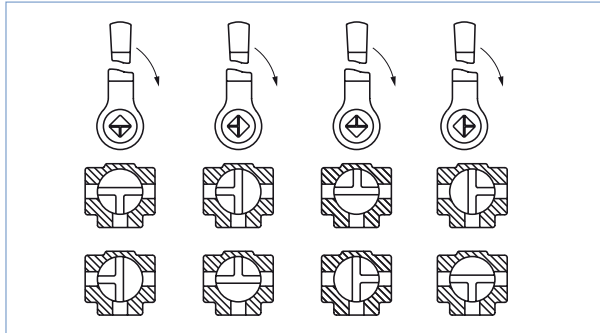

Switch positions  
L-bore

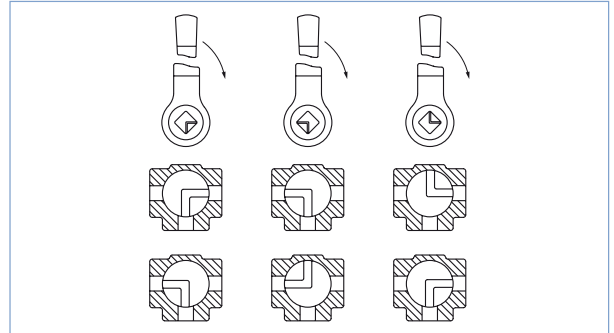

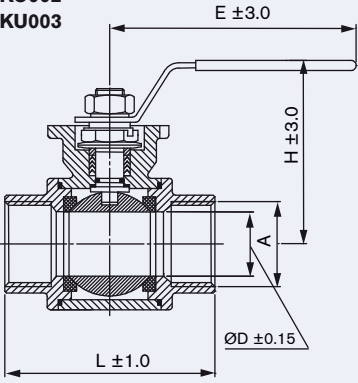
| TKU002<br>TKU003  | Materials                      | Temperature range       | DN [mm] | LTA | L [mm] | K <sub>v</sub> value [m <sup>3</sup> /h] | PN [bar] | Article no.<br>L bore    | Article no.<br>T bore    |
|---|--------------------------------|-------------------------|---------|-----|--------|--|----------|--------------------------|--------------------------|
|   |                                |                         |         |     |        |  |          |                          |                          |
|  | Body:<br>stainless st. 1.4401  | -10 °C<br>to<br>+200 °C | 11      | ¼"  | 80.5   | 2.8                                      | 63       | 789439 <a href="#">↗</a> | 789446 <a href="#">↗</a> |
|   |                                |                         | 12      | ⅜"  | 80.5   | 3  | 63       | 789493 <a href="#">↗</a> | 789447 <a href="#">↗</a> |
|   | Ball:<br>stainless st. 1.4401  |                         | 12      | ½"  | 80.5   | 3.6                                      | 63       | 789331 <a href="#">↗</a> | 789448 <a href="#">↗</a> |
|   | Seal: PTFE                     |                         | 15      | ¾"  | 88     | 6  | 63       | 789441 <a href="#">↗</a> | 789449 <a href="#">↗</a> |
|   | O Ring: FKM                    |                         | 20      | 1"  | 100    | 11                                       | 63       | 789442 <a href="#">↗</a> | 789397 <a href="#">↗</a> |
|   | Lever:<br>stainless st. 1.4301 |                         | 25      | 1¼" | 123    | 16                                       | 63       | 789443 <a href="#">↗</a> | 789450 <a href="#">↗</a> |
|   |                                |                         | 32      | 1½" | 140    | 25.5                                     | 63       | 789444 <a href="#">↗</a> | 789451 <a href="#">↗</a> |
|   |                                |                         | 40      | 2"  | 170    | 37.5                                     | 63       | 789445 <a href="#">↗</a> | 789452 <a href="#">↗</a> |

Ordering charts 2- and 3-way ball valve, stainless steel body, cont.

3-piece, threaded port

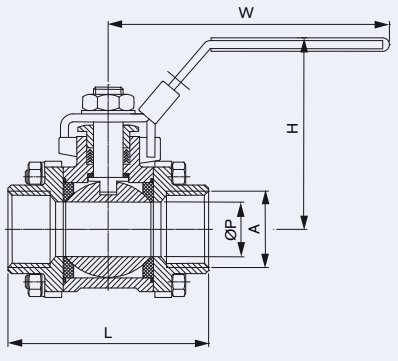
| TKU001<br>                          | Materials               | Temperature range |         |     |        |  |          | Article no. |
|--|-------------------------|-------------------|---------|-----|--------|--|----------|-------------|
|  |                         |                   | DN [mm] | LTA | L [mm] | K <sub>v</sub> value [m <sup>3</sup> /h] | PN [bar] |             |
| Body: stainless st. 1.4408<br>Ball: stainless st. 1.4401<br>Seal: PTFE<br>O Ring: FKM<br>Lever: stainless st. 1.4301 | -10 °C<br>to<br>+200 °C | 8                 | ¼"      | 60  | 5.4    | 63                                       | 789453   |             |
|  |                         | 10                | ⅜"      | 60  | 6      | 63                                       | 789454   |             |
|  |                         | 15                | ½"      | 75  | 16.3   | 63                                       | 789455   |             |
|  |                         | 20                | ¾"      | 80  | 29.5   | 63                                       | 789456   |             |
|  |                         | 25                | 1"      | 90  | 43     | 63                                       | 789457   |             |
|  |                         | 32                | 1¼"     | 110 | 89     | 63                                       | 789458   |             |
|  |                         | 40                | 1½"     | 120 | 230    | 63                                       | 789459   |             |
|  |                         | 50                | 2"      | 140 | 265    | 63                                       | 789460   |             |
|  |                         | 65                | 2½"     | 185 | 540    | 63                                       | 789461   |             |
|  |                         | 80                | 3"      | 205 | 880    | 63                                       | 789373   |             |
|  |                         | 100               | 4"      | 240 | 1380   | 63                                       | 789463   |             |

3-piece, butt weld connection

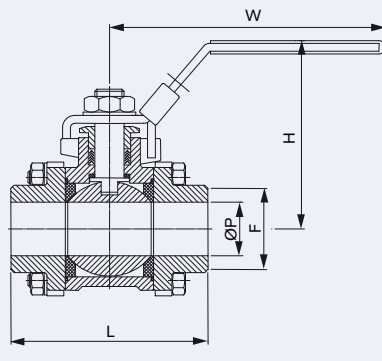
| TKU001<br>                         | Materials               | Temperature range |         |          |        |        |  | Article no. |
|--|-------------------------|-------------------|---------|----------|--------|--------|--|-------------|
|  |                         |                   | DN [mm] | P Ø [mm] | F [mm] | L [mm] | K <sub>v</sub> value [m <sup>3</sup> /h] |             |
| Body: stainless st. 1.4408<br>Ball: stainless st. 1.4401<br>Seal: PTFE<br>O Ring: FKM<br>Lever: stainless st. 1.4301 | -10 °C<br>to<br>+200 °C | 8                 | 11.6    | 12.5     | 65     | 5.4    | 63                                       | 789464      |
|  |                         | 10                | 12.7    | 15       | 70     | 6      | 63                                       | 789465      |
|  |                         | 15                | 16      | 18       | 75     | 16.3   | 63                                       | 789430      |
|  |                         | 20                | 20      | 22       | 90     | 29.5   | 63                                       | 789467      |
|  |                         | 25                | 25      | 28       | 100    | 43     | 63                                       | 789468      |
|  |                         | 32                | 32      | 35       | 110    | 89     | 63                                       | 789469      |
|  |                         | 40                | 38.1    | 43       | 125    | 230    | 63                                       | 789470      |
|  |                         | 50                | 50.8    | 54       | 150    | 265    | 63                                       | 789471      |
|  |                         | 65                | 65      | 69       | 190    | 540    | 63                                       | 789472      |
|  |                         | 80                | 80      | 84       | 220    | 880    | 63                                       | 789473      |
|  |                         | 100               | 100     | 104      | 270    | 1380   | 63                                       | 789474      |

To find your nearest Bürkert facility, click on the orange box →

[www.burkert.com](http://www.burkert.com)

In case of special application conditions, please consult for advice.

We reserve the right to make technical changes without notice.  
© Christian Bürkert GmbH & Co. KG

1803/6\_EU-en\_00895082