

# azbil

## WET PROCESS SENSORS/SWITCHES/FIBERS/FLOWMETERS

### SELECTION GUIDE



Please read "Terms and Conditions" from the following URL before ordering and use.

<https://www.azbil.com/products/factory/order.html>

Other product names, model numbers and company names may be trademarks of the respective company.

[Notice] Specifications are subject to change without notice.  
No part of this publication may be reproduced or duplicated without the prior written permission of Azbil Corporation.

**Azbil Corporation**  
Advanced Automation Company

*Yamatake Corporation changed its name to Azbil Corporation on April 1, 2012.*

1-12-2 Kawana, Fujisawa  
Kanagawa 251-8522 Japan  
URL: <https://www.azbil.com>

1st Edition: Apr. 2003-ST  
9th Edition: Oct. 2019-ED

## Liquid detection in the semiconductor and FPD manufacturing processes

# Sensor Selection by Process and Equipment

Liquid detection and measurement sensors & switches play key roles in a variety of equipment and processes.



**Equipment examples**  
- Chillers  
- Scrubbers  
- VMBs

Application **P. 9**

## HEAT TREATMENT

**Chiller**  
**Circulation fluid level detection**  
Easy liquid level detection without adjustment work.  
Pipe-mounted liquid level switches with built-in amplifier  
Model HPQ-T\_



Specifications P. 21

**Chiller**  
**Circulation liquid leak detection**  
Accurate detection without dependence on liquid conductivity  
Liquid leak switches with built-in amplifier  
Model HPQ-DP11/HPQ-DP12



Specifications P. 13

**Scrubbers**  
**Scrubbing liquid temperature measurement**  
**Chemical temperature measurement**  
Reduces element failure caused by condensation  
Chemical-resistant temperature sensors  
Model YYQZ01



Specifications P. 23

**Scrubbers**  
**Detection of scrubbing liquid level in tank**  
All-resin structure means no metallic contamination.  
Tank-inserted fiber-optic sensors  
Model HPF-D027/  
HPF-D033



Specifications P. 17

**CMP**

Application **P. 7**

**Equipment examples**  
Supply system for CMP chemicals

**Acid/alkali chemical liquid leak detection**  
Quick turnaround after a leak —no absorbent paper needed  
Liquid leak switches with built-in amplifier  
Model HPQ-D1\_ / HPQ-D2\_



Specifications P. 11

**Slurry/diluted chemical liquid level detection**  
Suitable for detection of cloudy liquids such as slurry  
Pipe-mounted fiber-optic liquid level sensors  
Model HPF-T032E/  
HPF-T034E



Specifications P. 19

**Chemical flow rate measurement**  
Micro flow rate—capable flowmeter  
Micro flow rate liquid flow meter  
Model F7M



Specifications P. 25

**PHOTO-LITHOGRAPHY**

**Equipment examples**  
- Coater/developer  
- Stepper

**Resist solution level detection**  
Space-saving, gang-mountable  
Pipe-mounted liquid level switches with built-in amplifier  
Model HPQ-T\_



Specifications P. 21

**Resist solution leak detection**  
Secure installation in tight spaces  
Liquid leak switches with built-in amplifier  
Model HPQ-D2\_



Specifications P. 11

**Chiller**  
**Liquid leak detection**  
Accurate detection without depending on liquid conductivity  
Liquid leak switches with built-in amplifier  
Model HPQ-DP11/HPQ-DP12



Specifications P. 13

**Resist solution flow rate measurement**  
Compact, lightweight flowmeter can be used anywhere with any solution  
Micro flow rate liquid flow meter  
Model F7M



Specifications P. 25

**CLEANING**

Application **P. 5**

**Equipment examples**  
- Single wafer cleaning system  
- Batch type cleaning machine  
- Etcher

**IPA liquid level detection**  
Fail-safe detection of liquid level upper and lower limits  
Pipe-mounted fiber-optic liquid level sensors  
Model HPF-T032E/  
HPF-T034E



Specifications P. 19

**IPA liquid leak detection**  
Suitable for liquid leak detection in explosive atmospheres  
Liquid leak detection fiber-optic sensors  
Model HPF-D040



Specifications P. 15

**Acid/alkali chemical liquid leak detection**  
Quick recovery even after liquid leak, requiring no absorbing paper.  
Liquid leak switches with built-in amplifier  
Model HPQ-D1\_ / HPQ-D2\_



Specifications P. 11

**Chemical temperature measurement**  
Reduces element failure caused by condensation.  
Chemical-resistant temperature sensors  
Model YYQZ01



Specifications P. 23

**Wafer detection**  
Bend radius of 20 mm for easy routing  
Chemical-resistant fiber-optic sensors  
Model HPF-T029/  
HPF-T035/  
HPF-D014



Specifications P. 24

**Cleaning solution flow rate measurement**  
Liquid-contacting areas made of fused quartz and fluororesin are resistant to corrosive fluids  
Micro flow rate liquid flow meter  
Model F7M



Specifications P. 25

# Sensor Selection by Chemical and Application

Liquid detection and measurement sensors & switches for a variety of chemicals and uses

	Acid/alkali chemicals	IPA etc. organic solvents	Resist solution	Circulation fluid/ pure water/water
<b>Liquid Leak Detection</b> P. 11-	Liquid leak switches with built-in amplifier Model HPQ-D1_  P. 11	Liquid leak detection fiber-optic sensor Model HPF-D040 Explosion-proof  P. 15	Liquid leak switches with built-in amplifier Model HPQ-D2_  P. 11	Liquid leak switches with built-in amplifier Model HPQ-DP11/HPQ-DP12  P. 13
<b>Liquid Level Detection</b> P. 17-	Tank-inserted fiber-optic sensors Model HPF-D027/HPF-D033  P. 17	Pipe-mounted fiber-optic liquid level sensors Model HPF-T032/T032E HPF-T034/T034E Explosion-proof  P. 19	Pipe-mounted liquid level switches with built-in amplifier Model HPQ-T_  P. 21	Pipe-mounted liquid level switches with built-in amplifier Model HPQ-T_  P. 21
<b>Temperature Measurement</b> P. 23-	Chemical-resistant temperature sensors Model YYQZ01  P. 23		Chemical temperature sensors Model YYQZ01  P. 23	Chemical temperature sensors Model YYQZ01  P. 23
<b>Object Detection</b> P. 24-	Chemical-resistant fiber-optic sensors Model HPF-T029/HPF-T035/HPF-D014  P. 24	Chemical-resistant fiber-optic sensors Model HPF-T029/HPF-T035/HPF-D014  P. 24		
<b>Flow Rate Measurement</b> P. 25-	Micro flow rate liquid flow meter Model F7M  P. 25	Micro flow rate liquid flow meter Model F7M  P. 25	Micro flow rate liquid flow meter Model F7M  P. 25	Micro flow rate liquid flow meter Model F7M  P. 25

Note: Models for use with a standard SUS (etc.) sheath are also available.

## INDEX Selection

by Equipment & Process P. 01

by Chemical & Application P. 03

Applications

Cleaning P. 05

CMP P. 07

Heat Treatment P. 09

Products

### Liquid Leak Detection

Switches + amp. / fiber-optic sensor  
 Model HPQ-D11 P. 11

HPQ-D12

HPQ-D13

HPQ-D21

HPQ-D22

HPQ-D23

HPQ-DP11 P. 13

HPQ-DP12

Liquid leak detection fiber  
 Model HPF-D040 P. 15

### Liquid Level Detection

Tank-inserted fiber-optic sensors  
 Model HPF-D027 P. 17

HPF-D033

Pipe-mounted fiber-optic liquid level sensors  
 Model HPF-T032/T032E P. 19

HPF-T034/T034E

Pipe-mounted liquid level switches with built-in amplifier  
 Model HPQ-T1 P. 21

HPQ-T2

HPQ-T1-002

HPQ-T1-003

HPQ-T1-004

HPQ-T2-005

### Temperature Measurement

Chemical resistant temperature sensor  
 Model YYQZ01 P. 23

### Object Detection

Chemical-resistant fiber-optic sensors  
 Model HPF-T029 P. 24

HPF-T035

HPF-D014

### Flow Rate Measurement

Micro flow rate liquid flow meter  
 Model F7M P. 25

Precautions for Handling P. 27

PFA Chemical Resistance P. 28

# CLEANING

**Equipment examples**

- Single wafer cleaning system
- Batch type cleaning machine
- Etcher

**Chemical temperature measurement**

**IPA liquid level detection**

**Chemical flow rate measurement**

**Acid/alkali chemical liquid leak detection**

**IPA liquid leak detection**

## IPA liquid level detection

Pipe-mounted fiber-optic liquid-level sensor  
Model HPF-T032E/HPF-T034E



## Fail-safe detection for upper and lower limits

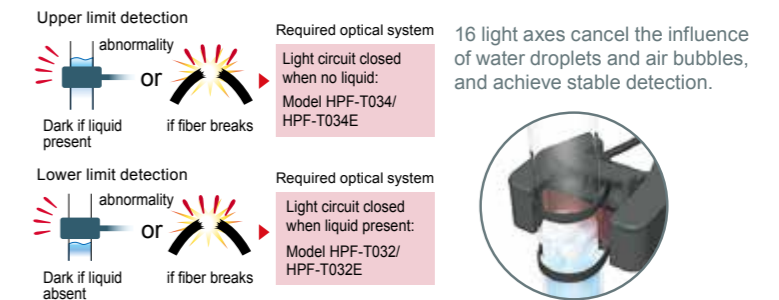

## Acid/alkali chemical liquid leak detection

Liquid leak switches with built-in amplifier  
Model HPQ-D1\_



## Quick turnaround after a leak, with no need for absorbent paper

**Easy maintenance**  
After leak detection, simply wipe the detector surface—a much easier process than with detection tape or a liquid-absorbing model.

**PFA protection for switch and cable**  
PVC bracket is available for acid/alkali detection, and PFA (with some SUS) for organic solvent detection.



## IPA liquid leak detection

Operating temperature ~ 70°C

Liquid leak detection fiber-optic sensors  
Model HPF-D040



## Suitable for liquid leak detection in explosive atmospheres.

**PFA protects the sensor and cable.**  
PFA protects the sensor and fiber-optic cable. SUS is partially used on the mounting base.

Hazardous location Non-hazardous location  
Fiber-optic switch Amplifier

## Chemical temperature measurement

Chemical-resistant temperature sensors  
Model YYQZ01



## Less element failure by condensation

Two models with different materials are available.  
Temperature measurement ranges  
0 to 200°C (FEP) 0 to 250°C (PFA)



## Acidic/alkaline chemical flow rate measurement Thermal Micro Flow Meter

Micro flow rate liquid flow meter  
Model F7M



## To resist corrosive fluids, liquid-contacting areas are made of fused quartz and fluororesin

This micro flow meter has an IP65 protective structure with a surface that is completely metal-free, so it can be used in environments where it is exposed to splashing liquid.

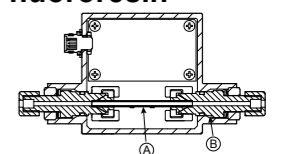

No.	Item	Material	Notes
A	Sensor tube	Fused quartz glass	-
B	Fitting	PFA, PTFE	The material used for the included sleeves is PFA.

# CMP

Equipment examples  
CMP

Slurry/diluted  
chemical liquid level  
detection

Diluent flow rate  
measurement

Chemical supply system

Equipment examples  
Coater, developer

Resist liquid  
level detection

Acid/alkaline  
liquids leak detection

Acidic/alkaline chemical  
flow rate measurement

## Slurry/diluted chemical liquid level detection

Pipe-mounted fiber-optic liquid level sensors  
Model HPF-T034E



## Suitable for detection of cloudy liquids such as slurry

Regardless of whether the target liquid is cloudy or transparent, light refracts in the same way, so there is no reversal of the sensor's operation. As a result, the same settings can be used for level detection of the slurry and of washing water.

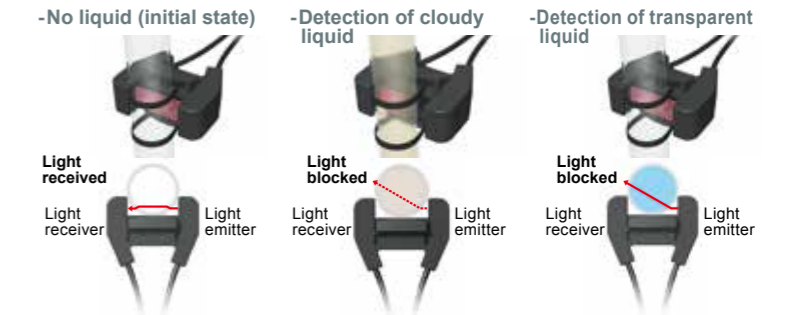

## Resist solution leak detection

Liquid leak switch with built-in amplifier  
Model HPQ-D2\_



## Secure installation in tight spaces

Equipped with locking mechanism  
Secure installation is ensured by using the support lever on the switch.

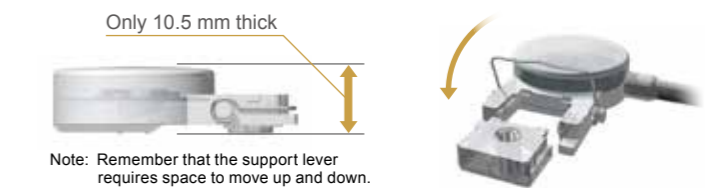

## Resist solution level detection

Pipe-mounted liquid level switches with built-in amplifier  
Model HPQ-T\_



## Space-saving and gang-mountable

Indicator and operation selector switch are on the side, so even when switches are gang-mounted, it is easy to make adjustments while viewing the indicator.

Fits various pipe diameters  
switches fit on pipe diameters of 8 to 13 mm, 3 to 7 mm, and 1/16 inch. They can be mounted using a cable tie or M3 screw.

## Diluent/cleaning solution flow rate measurement

Micro flow rate liquid flow meter  
Model F7M



## Measurement of 50 ml/min and lower flow rates

This flowmeter employs a thermal measurement principle and MEMS sensing technology, making it possible to measure micro flow rates (50 ml/min and less), which is difficult to accomplish with conventional measurement methods.

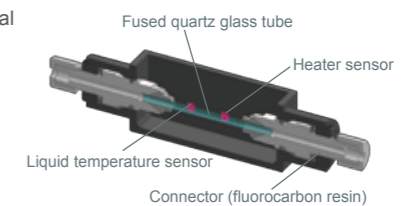

- Heater surface temperature is constantly controlled to keep it at a fixed value that is slightly higher than the fluid temperature.
- Heat dissipation from the heater changes depending on the flow rate.
- As the flow rate rises, the amount of heat transferred to the fluid increases, and the power consumption of the heater increases.
- By measuring the heater's power consumption, the flow rate can be calculated. (Heat dissipation from the heater is quite small that it does not heat the fluid.)

# HEAT TREATMENT

**Equipment examples**

- Chillers
- Scrubbers
- VMBs

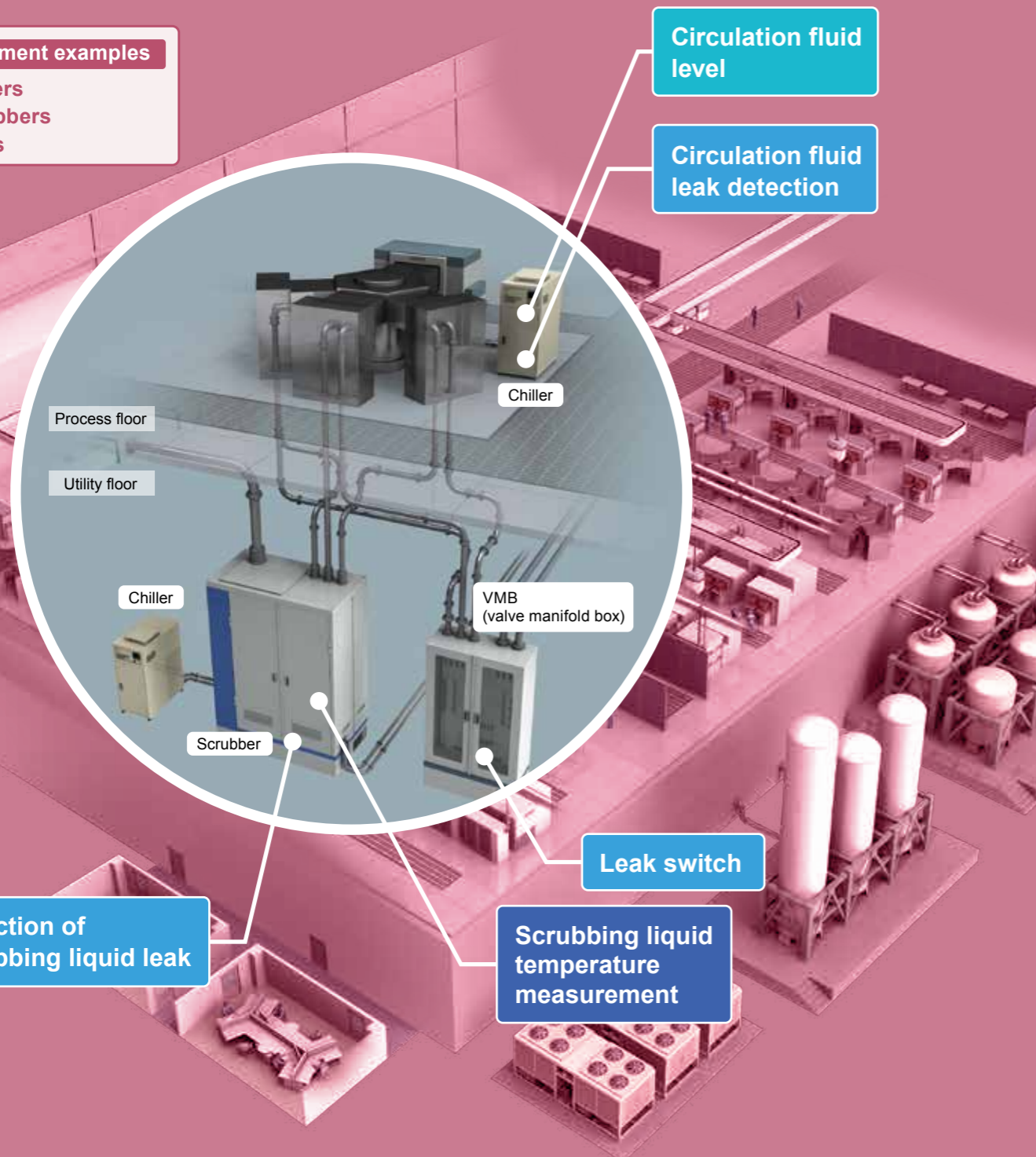

**Detection of chiller circulation fluid level**

Pipe-mounted liquid level switches with built-in amplifier  
Model HPQ-T\_

UL US CE

**Easy liquid level detection without tuning**

Refractive detection ensures sufficient gain between light-ON and dark-ON light levels. This switch is also suitable for liquids with poor light transmission (such as resist liquid and waste fluids).

**Operation panel located on the side**

With the indicator and operation selector switch located on the side, even when switches are gang-mounted, it is easy to make adjustments while checking the indicators.

**Leak detection for chiller circulation fluid**

Liquid leak switches with built-in amplifier  
Model HPQ-DP11/  
HPQ-DP12

Switch: PP  
Mounting base: PP

UL US CE

**Accurate detection regardless of liquid conductivity**

The switch detects liquid leaks optically, so it does not rely on liquid conductivity. Accessories for indirect detection of liquid leaks, such as liquid absorbing paper, are unnecessary.

**Easy maintenance**

After leak detection, simply wipe the detector surface—a much easier process than with detection tape or a liquid-absorbing model.

**Detection of scrubber liquid level in tank**

Tank-inserted fiber-optic sensors  
Model HPF-D027/  
HPF-D033

**Detection of tank liquid level for scrubbers — all-resin structure means no chance of metallic contamination**

No metal is used in Model HPF-D027 or HPF-D033, even on the inside, thanks to PFA tube structure.

**4 mm dia. model for easy routing**

Model HPF-D033's PFA tube has a space-saving outer diameter of 4 mm. Its structure also facilitates routing.

**Stray drop protection for reliable detection**

The sensor shape is designed so that drops accumulate at the tip, reducing malfunctions.

**Temperature measurement for scrubber liquid**

Chemical-resistant temperature sensors  
Model YYQZ01

**Less element failure by condensation**

Two models with different materials are available. Temperature measurement ranges

**0 to 200°C (FEP) 0 to 250°C (PFA)**

RTD element is embedded in Teflon resin to greatly reduce element failure caused by condensation.

# Liquid leak detectors with built-in amplifier

Model HPQ-D1\_/HPQ-D2\_

Optical type

Built-in amplifier, no absorbent paper required, usable with various liquids.



Acids or alkaline liquids, IPA (isopropyl alcohol), pure water, Fluorinert, Galden, etc.

Notes: For explosion-proof applications, be sure to select a suitable fiber type. Fluorinert and Galden are registered trademarks of 3M and Solvay Solexis respectively.

Easy maintenance

After leak detection, simply wipe the detector surface—a much easier process than with detection tape or a liquid-absorbing model.

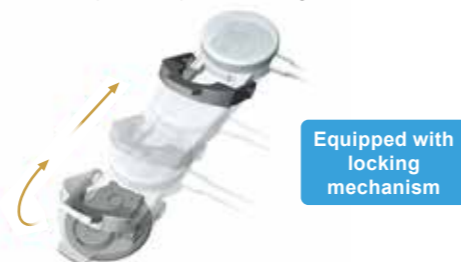

PFA protection for switch and cable

PVC bracket is available for acid/alkali detection, and PFA (with some SUS) for organic solvent detection.

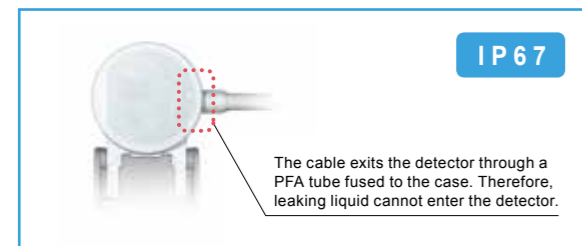

Suitable for export equipment

CE marking, UL certified. Wide variety of output modes and types are available.  
- NO/NC output  
- NPN/PNP output



Operation indicator

Switch status can be checked from the body side.

Normal state (green LED lit)  
Liquid leakage (red LED lit)

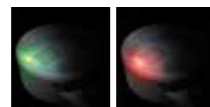

## DETECTION PRINCIPLE

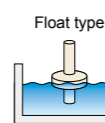
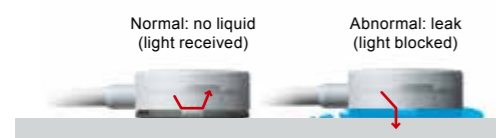

Install this switch in the pan by stud or adhesive (for PVC bracket type). Unlike the float type, switch does not require a concave surface underneath.

Note: This switch is not explosion-proof. Do not use it where the use of an explosion-proof product is specified.

## CATALOG LISTING

Detection method & shape	Bracket material	Operation mode	Output mode	Catalog listing
	PVC	NC	Open collector NPN	HPQ-D11
		NO	Open collector PNP	HPQ-D12
	PFA (SUS)	NC	Open collector NPN	HPQ-D21
		NO	Open collector PNP	HPQ-D22
			Open collector NPN	HPQ-D23

Notes: • For Model HPQ-D11/12/21 models, a switch with 5m cable (2m PFA tube) is also available, specially produced for the U.S. market (-L05).  
• Normally open type: no UL certification.  
• For product details, contact one of our sales representatives or an Azbil dealer.

## ACCESSORY

Mounting base material	Catalog listing
PVC bracket (10 units)	HPQ-B01
PFA (SUS) bracket (10 units)	HPQ-B02

## SPECIFICATIONS

Catalog listing	Mounting base : PVC	HPQ-D11	HPQ-D13	HPQ-D12
	Mounting base : PFA	HPQ-D21	HPQ-D23	HPQ-D22
Detection method	Retroreflective			
Mounting surface	Polyvinyl chloride or stainless steel plate*			
Standard target object	Water*			
Light source	Infrared LED (peak emission wavelength 940 nm)			
Supply voltage	10.8 to 26.4 Vdc (ripple voltage 10 % max.)			
Current consumption	30 mA or less			
Operation mode	Normally ON, when leak detected OFF	Normally OFF, when leak detected ON	Normally ON, when leak detected ON	Normally ON, when leak detected OFF
Output mode	Open collector NPN		Open collector PNP	
Control output	Switching current	50 mA or less (resistive load)		
	Output withstand voltage	30 Vdc		
Indicator	Residual voltage	1 V max. (at 50 mA switching current)		
	Normally green light ON, when leak detected orange light ON			
Operating temperature	-25 to +50 °C (without freezing)			
Storage temperature	-40 to +70 °C (without freezing)			
Operating humidity	30 to 85 % RH (without condensation)			
Dielectric strength	20 MΩ (at 500 Vdc)			
Withstand voltage	1,000 Vac, 50/60 Hz for 1 min between all electrically live metal and case			
Vibration resistance	10 to 55 Hz, 1.5 mm peak-to-peak amplitude, 2 h each in X, Y, and Z directions			
Shock resistance	500 m/s <sup>2</sup> 3 times each in X, Y, and Z directions			
Protective structure	IP67 (IEC standard)			
Protection circuits	Built-in reverse connection protection, malfunction prevention at power ON (approx. 20 ms), output short-circuit protection			
Connection method	Preloaded, 2 m cable			
Material	Body: PFA. Cable: PFA coating. Mounting base: PVC or PFA (SUS)			
Mass	Approx. 55 g (main unit with 2 m cable)			

\*Operation may be unstable depending on the color and condition of the mounting surface or the liquid. Before use, carefully check switch operation in the actual situation.

## EXTERNAL DIMENSIONS

Unit: mm

### Model HPQ-D1\_

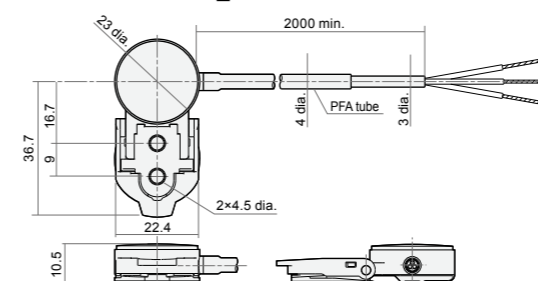

### Model HPQ-D2\_

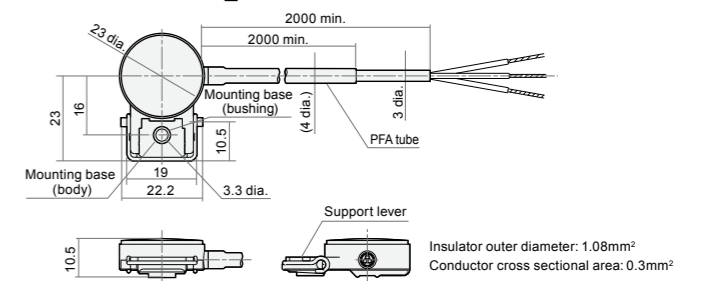

## OUTPUT CIRCUIT DIAGRAM

### Model HPQ-D\_1/HPQ-D\_3 (NPN type)

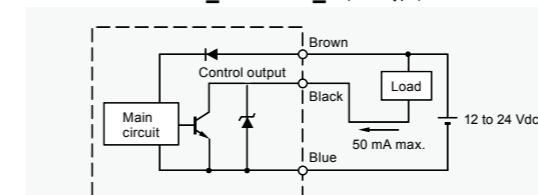

### Model HPQ-D\_2 (PNP type)

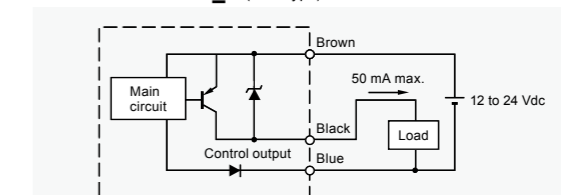

# Liquid leak detectors with built-in amplifier

Model HPQ-DP11/HPQ-DP12

Built-in amplifier, no absorbent paper required, usable with various liquids.



For pure water, industrial water, Fluorinert, Galden, etc.

Notes: For explosion-proof applications, be sure to select a suitable fiber type. Fluorinert™ is a registered trademark of 3M and Galden™ is a registered trademark of Solvay Solexis.

## Optical method detects liquid leakage directly

Detection is possible immediately after installation even without sensitivity adjustment. Accessories used in indirect detection of leaks, such as absorbent paper, are unnecessary. Detection performance does not depend on the conductivity of the target liquid.

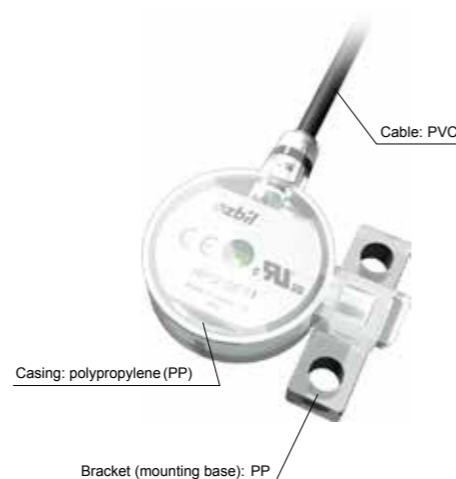

## Fast and easy maintenance

After leak detection, simply wipe off the detector's surface—a much easier process than with detection tape or a liquid-absorbing model.



### DETECTION PRINCIPLE

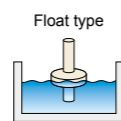

Install this switch in the pan by stud or adhesive (for PVC bracket type). Unlike the float type, switch does not require a concave surface underneath.

### CATALOG LISTING

Detection method & shape	Bracket material	Operation mode	Output mode	Catalog listing
	PP	NC	Open collector NPN	HPQ-DP11
			Open collector PNP	HPQ-DP12

Note: Model with 5 m cable is also available.

### SPECIFICATIONS

Catalog listing	HPQ-DP11	HPQ-DP12
Detection method		
Detection method	Retroreflective	
Mounting surface	Polyvinyl chloride or stainless steel plate*	
Standard target object	Water*	
Light source	Infrared LED	
Supply voltage	10.8 to 26.4 VDC (ripple voltage 10 % max.)	
Current consumption	10 mA or less	
Operation mode	Normal state: ON. State when leak detected: OFF	
Output mode	Open collector NPN	Open collector PNP
Control output	Switching current	50 mA or less (resistive load)
	Output withstand voltage	30 Vdc
	Residual voltage	DP11: 1 V max. (at 50 mA switching current), DP12: 2 V max. (at 50 mA switching current)
Indicator	Normally green light ON, when leak detected red light ON	
Operating temperature	-10 to +60 °C (without freezing)	
Storage temperature	-20 to +70 °C (without freezing)	
Operating humidity	30 to +85 % RH (without condensation)	
Dielectric strength	20 MΩ (at 500 Vdc)	
Withstand voltage	1,000 Vac, 50/60 Hz for 1 min between all electrically live metal and case	
Vibration resistance	10 to 55 Hz, 1.5 mm peak-to-peak amplitude, 2 h each in X, Y, and Z directions	
Shock resistance	490 m/s <sup>2</sup> 3 times each in X, Y, and Z directions	
Protective structure	IP67 (IEC standard)	
Protection circuits	Output short-circuit protection, output eddy current protection	
Connection method	Prelead, 2 m cable	
Material	Casing: PP. Cable: PVC. Mounting base: PP.	
Mass	Approx. 30 g (main unit only with 2 m cable)	

\*Operation may be unstable depending on the color and condition of the mounting surface or the liquid. Before use, carefully check switch operation in the actual situation.

### EXTERNAL DIMENSIONS

Unit: mm

#### Model HPQ-DP

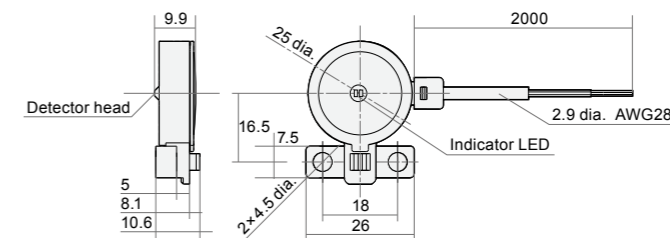

### OUTPUT CIRCUIT DIAGRAM

#### Model HPQ-DP11 (NPN type)

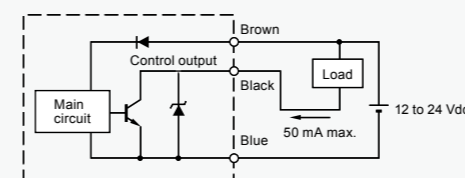

#### Model HPQ-DP12 (PNP type)

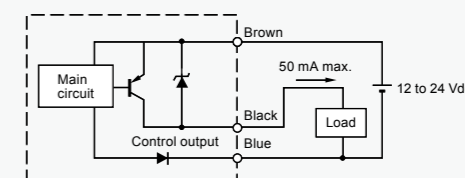



# Liquid leak detection fiber-optic sensors

Model HPF-D040

Inherently safe product.  
PFA protects sensor and cable.  
Saves space.

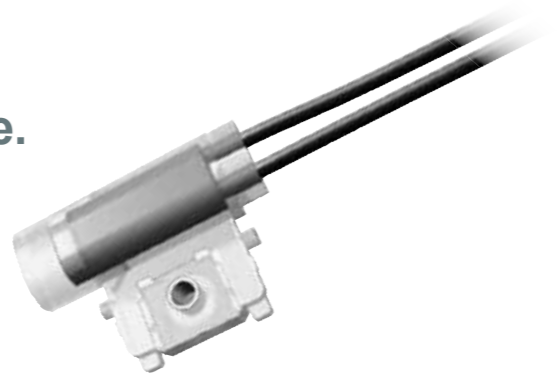

Inherently safe product	PFA protection Case Cable	R20 Free Cut	5m	Operating temperature -30 to +70°C
-------------------------	---------------------------	--------------	----	------------------------------------

## PFA protects sensor and cable.

Usable in an atmosphere with organic solvents such as IPA.

Notes: SUS is partially used on the mounting bracket.

## Saves space

Sensor head has a height of only 9.9 mm.

### DETECTION PRINCIPLE

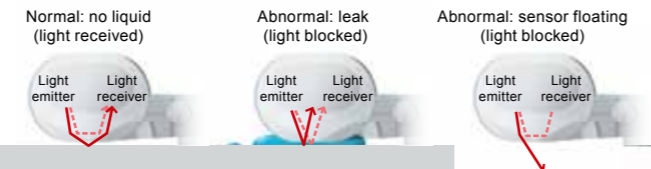

When a leak is detected, no light reaches the receiver. Since the same is true in a fiber cable break or disconnection, operation is fail-safe. Install in the pan with a stud.

### CATALOG LISTING

#### Diffuse scan

Shape (mm)	Cable		Catalog listing
	Bend radius	Length	
 -30 to +70°C	R20	5m Free cut	HPF-D040

### SPECIFICATIONS

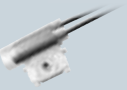
Catalog listing	HPF-D040
Appearance	
Detection method	Retroreflective (contact type)
Compatible amplifier (Model No.)	HPX-EG
Standard target liquid	IPA (isopropyl alcohol)
Operating temperature	-30 to +70 °C
Material	Sensor: PFA. Cable: polyethylene (PFA coated). Bracket: PFA (and SUS)

#### Note: Use of sensor in explosive atmosphere

The fiber unit can be used in a hazardous location by installing the amplifier unit in a non-hazardous location. However, before using the fiber-optic sensor, carefully check the explosion-proof regulations for the facility and equipment

### EXTERNAL DIMENSIONS

Unit: mm

#### Model HPF-D040

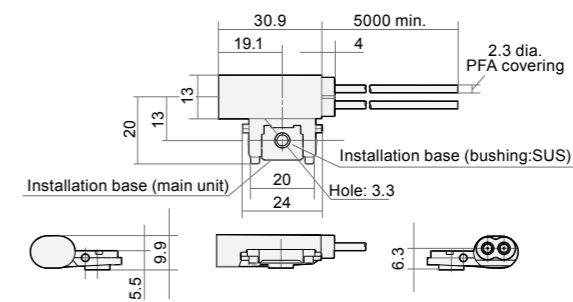

# Tank-inserted fiber-optic sensors

Model HPF-D027/HPF-D033

**All-resin structure ensures no metal contamination.**

- 4mm diameter allows easy running of cables.
- Reliable detection by preventing liquid cling!



Inherently safe product PFA protection Case Cable

## Reliable detection by preventing liquid cling!

Proprietary tip structure prevents liquid from clinging to the tip, eliminating a cause of faulty operation.

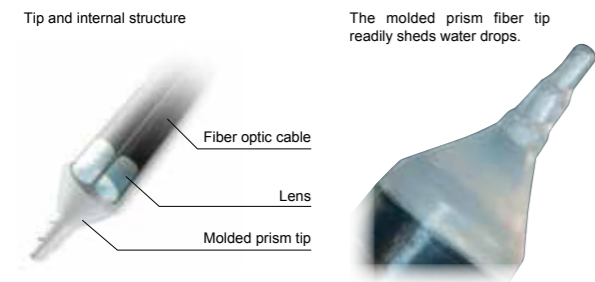

### DETECTION PRINCIPLE

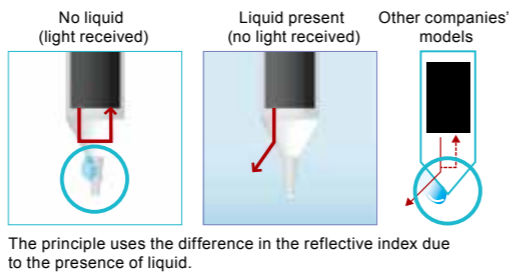

## Recommended compatible amplifier unit

Model HPX-EG  
<Exterior view>



### Auto sensitivity switch function

This function automatically optimizes the sensitivity setting during auto tuning, affording easy operation while delivering the highest detection performance.

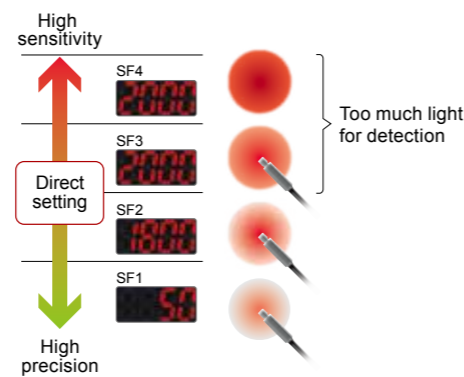

Ex. of light quantity difference (with water)

No liquid: 2,800  
With liquid: 215  
When combined with Model HPX-EG (nL3 mode)

Light quantity in nL4 mode



Since 4000 is the maximum in nL4 mode, the saturation point may have been reached.

Light quantity in nL3 mode



4000 is also the maximum in nL3 mode. Since the reading is now 2,800, you can be sure that the saturation point has not been reached.

Note: In some cases of saturation, it may not be possible to adjust the setting. If the saturation point is reached for incoming light when no liquid is present, change the sensing type.

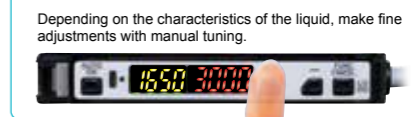
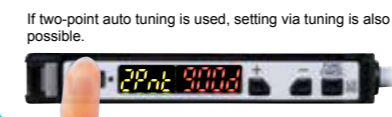
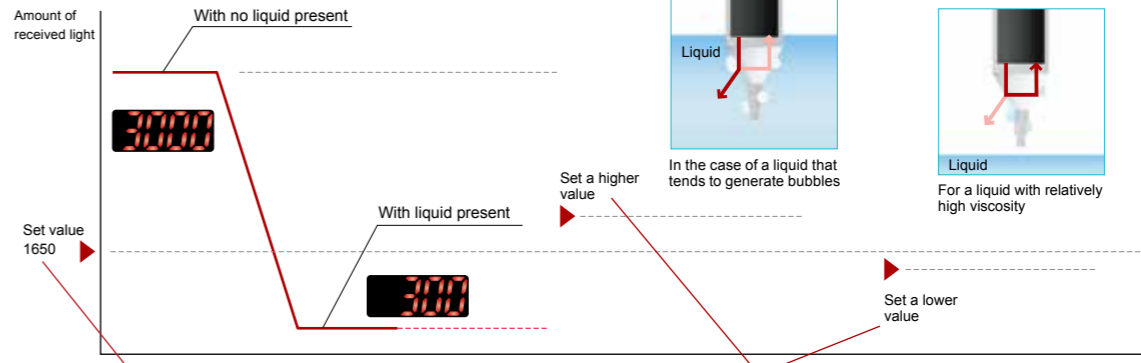

## Setting the sensitivity

The fiber unit is used with a Model HPX-EG amplifier.





## CATALOG LISTING

### Diffuse scan

Type	Shape	Cable		Catalog listing
		Bend radius	Length	
4 dia	 -30 to +105 °C	PFA area: R30 Cable area: R15	2m Free cut	HPF-D033
6 dia	 -30 to +105 °C	PFA area: R40 Cable area: R25	2m Free cut	HPF-D027

## SPECIFICATIONS

Catalog listing	HPF-D027	HPF-D033
Appearance		
Detection method	Retroreflective (contact type)	
Compatible amplifier (Model No.)	HPX-EG	
Repeat accuracy	1 mm or less (for water)	
Standard target liquid	Liquid*	
Pressure resistance	-49 to 490 kPa	
Operating temperature	-30 to +105 °C	
Material	Polyethylene (PFA coated)	

\*Depending on the color and viscosity of the liquid, detection may not be possible.

## EXTERNAL DIMENSIONS

Unit: mm

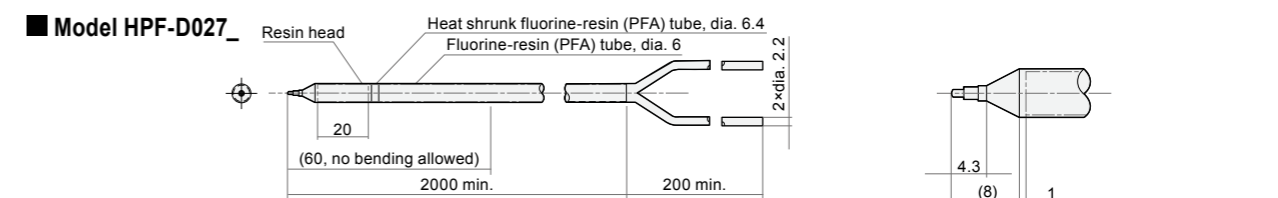
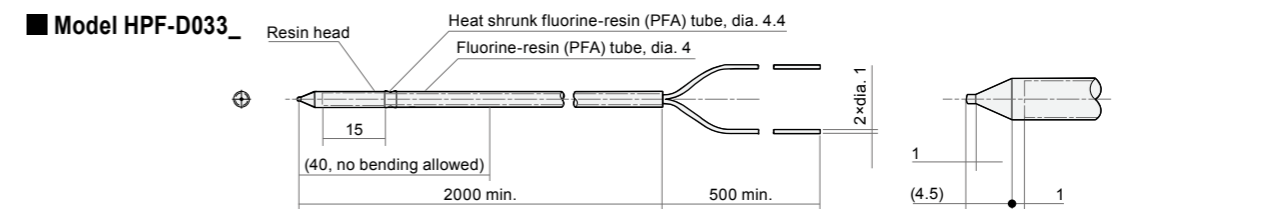

# Pipe-mounted fiber-optic liquid level sensors

Model HPF-T032/HPF-T032E  
HPF-T034/HPF-T034E

## Fail-safe detection of tank upper and lower liquid level limits

- An array of 16 optical axes eliminates the effects of air bubbles and water droplets
- PFA-jacketed fiber
- Fits a wide range of pipe diameters.
- Location of the optical axes is clearly marked.



Inherently safe product	Pipe dia. 8 to 19 mm dia. T034, T034E	Pipe dia. 3 to 13 mm dia. T032, T032E	PFA protection Cable	R4	5m Free Cut
-------------------------	---------------------------------------	---------------------------------------	----------------------	----	-------------

### Array of 16 optical axes eliminates the effects of air bubbles and water droplets



Adverse effects from air bubbles and water droplets are reduced, resulting in reliable detection.

### PFA-jacketed optical fiber

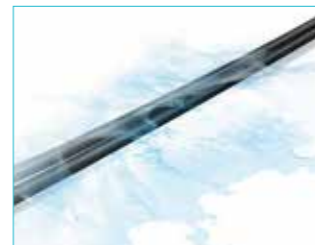

Fiber-optic cables protected by chemical-resistant resin can be run through machines and equipment safely (Model HPF-T032 and HPF-T034 only).

### Fits a variety of pipe diameters.

Designed for pipes 3 to 19 mm in dia.

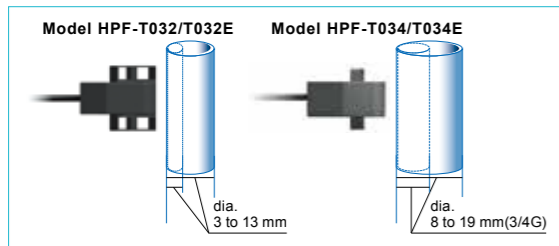

### Position of optical axes is marked

Position of the optical axis array is easily visible.



### DETECTION PRINCIPLE

Operating principle of Model HPF-T032 and T032E

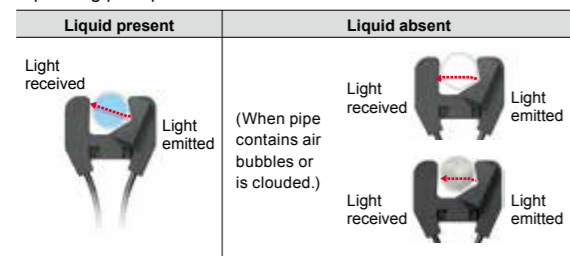

Clouding and bubbles reduce the level of received light, but thanks to the operating principle (light = liquid present) they do not increase the risk of false detection.

Operating principle of Model HPF-T034 and T034E

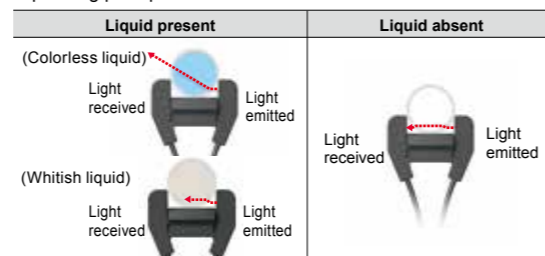

Light reception is blocked when liquid is present, which prevents false detection due to a change in the liquid's color.

### Fail-safe detection for upper and lower limits

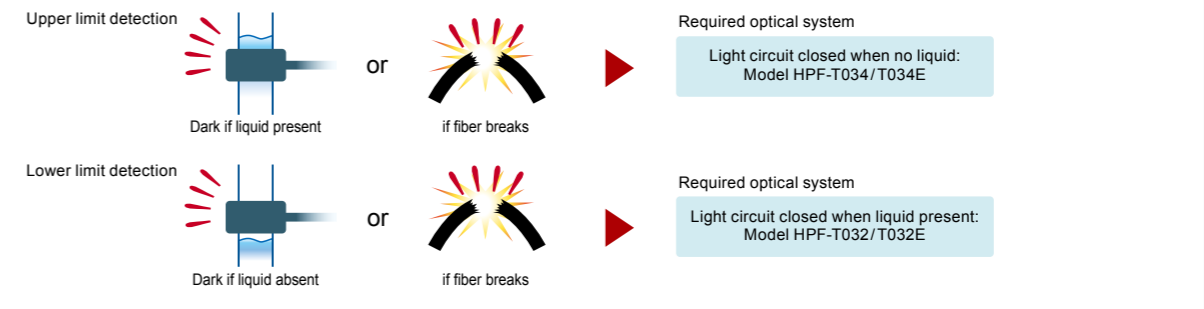

### Setting the sensitivity

Easy setup is done without the process liquid.

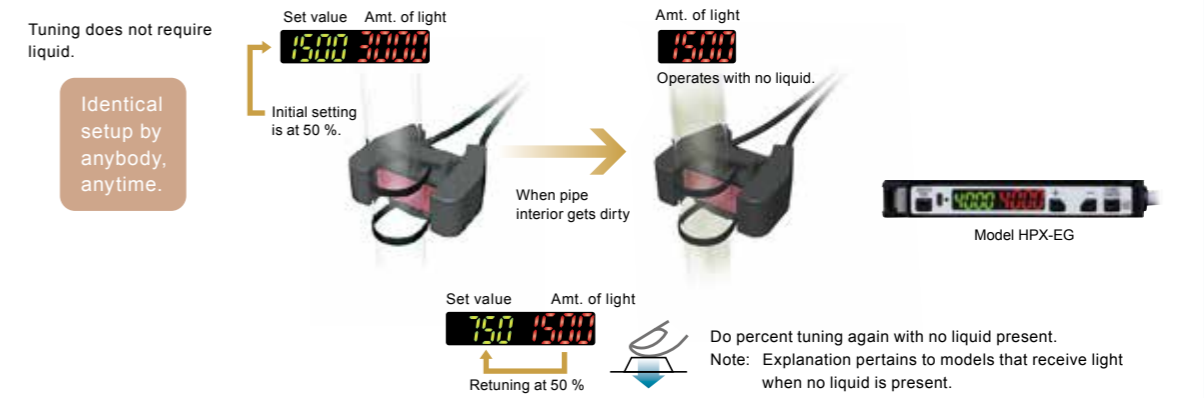

### CATALOG LISTING

Type	Compatible pipe dia.	Shape	Bend radius	Cable		Catalog listing
				Length	Coating material	
Liquid-present received light	3 to 13mm dia.		R4 -30 to +105 °C	5m	PFA	HPF-T032
				2m	Polyethylene	HPF-T032E
				Free cut		HPF-T032E-L02
				Free cut		
Liquid-absent received light	8 to 19mm dia. (3/4B)		R4 -30 to +105 °C	5m	PFA	HPF-T034
				2m	Polyethylene	HPF-T034E
				Free cut		HPF-T034E-L02
				Free cut		

- Use with PFA transparent pipe with wall thickness of 1 mm.
- Depending on the pipe actually used, as well as the liquid thru scan and refractive ratios, fiber unit detection may not be reliable, so be sure to test the operation before use.
- If the fiber unit is used with other than the recommended pipe, material, or wall thickness, please test before use or consult our sales staff.

### EXTERNAL DIMENSIONS

#### Model HPF-T032/HPF-T032E/HPF-T032E-L02

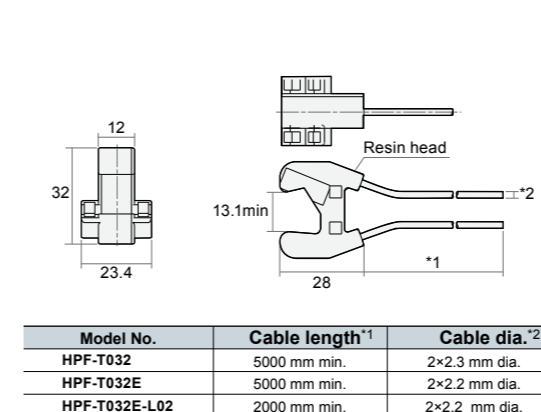

Model No.	Cable length <sup>1</sup>	Cable dia. <sup>2</sup>
HPF-T032	5000 mm min.	2×2.3 mm dia.
HPF-T032E	5000 mm min.	2×2.2 mm dia.
HPF-T032E-L02	2000 mm min.	2×2.2 mm dia.

#### Model HPF-T034/HPF-T034E/HPF-T034E-L02

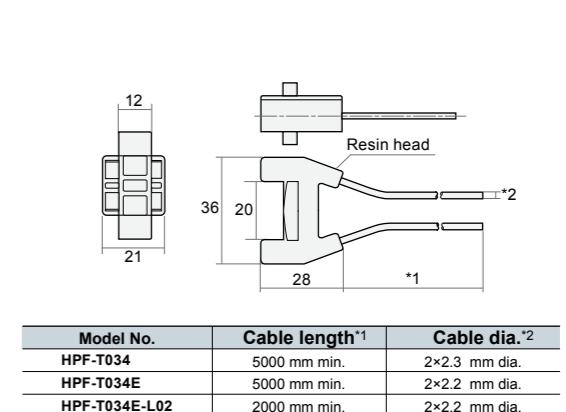

Model No.	Cable length <sup>1</sup>	Cable dia. <sup>2</sup>
HPF-T034	5000 mm min.	2×2.3 mm dia.
HPF-T034E	5000 mm min.	2×2.2 mm dia.
HPF-T034E-L02	2000 mm min.	2×2.2 mm dia.

# Pipe-mounted liquid level switches with built-in amplifier

Model HPQ-T1\_/HPQ-T2\_

Just by mounting the switch on a pipe, the surface of the liquid can be easily detected.

- Reliable detection
- Operation panel is located on the side.
- Fits various pipe diameters
- The same model can be used for upper or lower limit detection.



## Reliable detection

Refraction-based detection ensures sufficient gain between light-ON and dark-ON light levels. This switch is also suitable for liquids with poor light transmission (such as photoresist liquid and waste fluids).

## Fits various pipe diameters

Switches fit on pipes with diameters of 1/16 inch, 3 to 7 mm, and 8 to 13 mm. They can be mounted using a cable tie or M3 screw.

## Operation panel on the side

Indicator and operation selector switch are located on the side. Even when switches are gang-mounted, they can be adjusted while viewing the indicator.

## Same model handles upper or lower limit detection

Note: For pipe diameters of 8 mm or less, please contact us. switches with adjustable sensitivity are also available.

### DETECTION PRINCIPLE

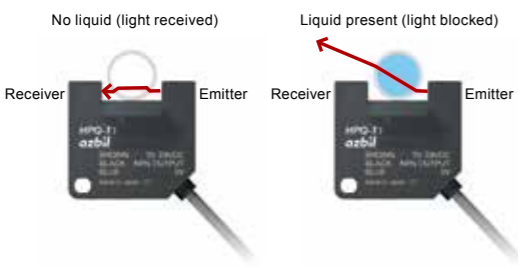

### Optical axis position

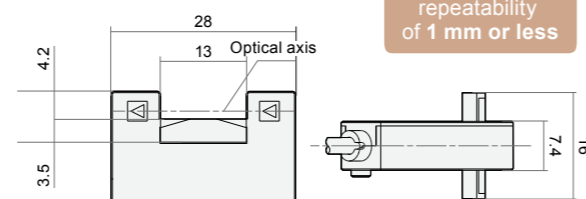

Note: The slit width is 1 mm, and therefore repetitive detection is possible at an accuracy of that width or less. This varies depending on the condition of the liquid.

Detection repeatability of 1 mm or less

### Example of fail-safe setup



### Example of recommended settings

	LO/DO setting	Liquid present	Liquid absent	Abnormal condition	switch failure "open"
Upper limit	LO	OFF	ON	Liquid present	OFF
Lower limit	DO	ON	OFF	No liquid	OFF

## CATALOG LISTINGS

Detection method, shape	Bracket	Sensitivity adjustment	Output mode	Catalog listing
Thru-scan 	8 to 13mm dia.	-	Open collector NPN transistor	HPQ-T1
		-	Open collector PNP transistor	HPQ-T2
		○	Open collector NPN transistor	HPQ-T1-002
	3 to 7mm dia.	○	Open collector NPN transistor	HPQ-T1-003
		-	Open collector NPN transistor	HPQ-T1-004
		-	Open collector PNP transistor	HPQ-T2-005

Model HPQ-T1/T2 models are also available with a 5 m cable. For models that fit 1/16-inch diameter pipes, please contact a sales representative.

## SPECIFICATIONS

Catalog listing	HPQ-T1	HPQ-T1-002	HPQ-T1-003	HPQ-T1-004	HPQ-T2	HPQ-T2-005	
Detection method	Thru-scan						
Applicable pipe sizes	8 to 13 mm dia. 1 mm thick	○	○	○	-	○	
	3 to 7 mm dia. 0.6 to 1 mm thick	-	-	-	○	○	
Applicable pipe material	Transparent PFA pipe						
Standard target object	Water*						
Repetitive detection positional accuracy	1 mm or less						
Light source	Infrared LED (peak emission wavelength 950 nm)						
Supply power	10 to 28 Vdc (ripple voltage 10 % max.)						
Current consumption	25 mA or less						
Operation mode	Light-on (LO)	-	○	-	-	-	
	Dark-on (DO)	-	-	○	-	-	
	LO/DO switching	○	-	-	○	○	
Output mode	Open collector NPN	○	○	○	-	-	
	Open collector PNP	-	-	-	-	○	
Control output	Switching current	100 mA or less (resistive load)					
	Output withstand voltage	30 Vdc					
	Residual voltage	1 V or less (at 100 mA switching current)					
Response time	2 ms or less (operation and return)						
Sensitivity adjustment	-	○	○	-	-	-	
Indicator	Operation indicator: red (lit when output ON)						
Ambient light immunity	1,000 lux max. (incandescent lamp)						
Operating temperature range	-10 to +55 °C (without freezing)						
Storage temperature range	-25 to +70 °C (without freezing)						
Operating humidity range	30 to 85 % (without condensation)						
Dielectric strength	20 MΩ (at 500 Vdc)						
Withstand voltage	1000 Vac, 50/60 Hz for 1 min between all electrically live metal and case (500 Vac for L-ON/D-ON selector switch and sensitivity adjustment potentiometer)						
Vibration resistance	10 to 55 Hz, 1.5 mm peak-to-peak amplitude, 2 h each in X, Y, and Z directions						
Shock resistance	500 m/s <sup>2</sup> 3 times each in X, Y, and Z directions						
Protective structure	IP50 (IEC standard)						
Protection circuits	Built-in reverse connection protection, malfunction prevention at power ON (approx. 20 ms), output short-circuit protection						
Connection method	Preleaded, 2 m cable (HPQ-T1/T2 with 5 m cable also available)						
Material	Case: polycarbonate resin. Cable tie: nylon. Tube: silicone						
Mass	Approx. 25 g (main unit only with 2 m cable)						

\*Depending on the pipe used, as well as the degree of transparency and the refractive index of the liquid, reliable detection may not be possible. Before use, carefully check switch operation in the actual situation, especially if the pipe type, material or thickness differs from the specification.

## EXTERNAL DIMENSIONS

Unit: mm

### Model HPQ-T\_

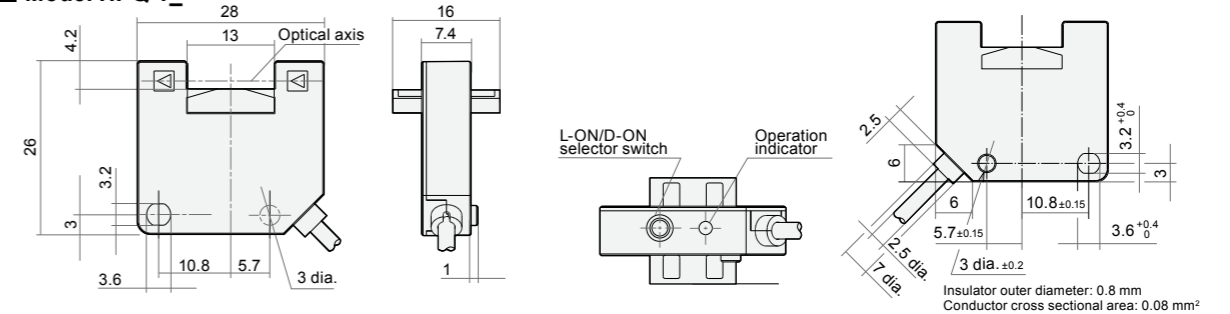

## OUTPUT CIRCUIT DIAGRAM

### Model HPQ-T1 (NPN type)

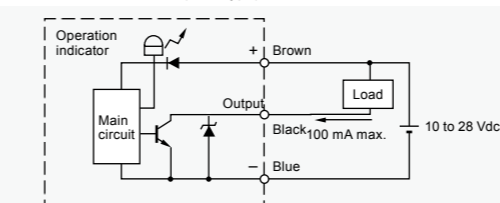

### Model HPQ-T2 (PNP type)

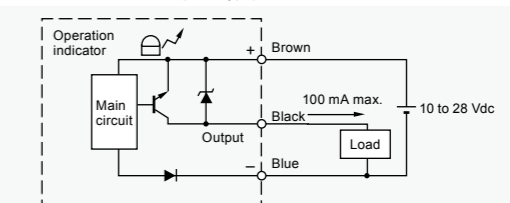

# Chemical-resistant temperature sensors

Model YYQZ01

Ideal for temperature control in wet process treatment tanks and piping!



Explosion-proof PFA-protected Cable

Two models with different temperature ranges of 0 to 200 °C (FEP) and 0 to 250 °C (PFA) are available.

RTD element is embedded in Teflon resin to greatly reduce element failure caused by condensation.



## SPECIFICATIONS

Size	Protection tube		Lead		Temperature measurement range	Rated current	Tolerance	Terminal size	Catalog listing
	Material	Length	Connection method	Length					
4mm dia.	FEP	200mm	3-wire method	1m	0 to 200 °C	1mA	Class B	M3.5	YYQZ01BF420010B0
	PFA				0 to 250 °C				YYQZ01BP420010B0
6mm dia.	FEP	200mm	3-wire method	1m	0 to 200 °C	1mA	Class B	M3.5	YYQZ01BF620010B0
6mm dia.	PFA				0 to 250 °C				YYQZ01BP620010B0

## EXTERNAL DIMENSIONS

Unit: mm

### 4 mm dia. type

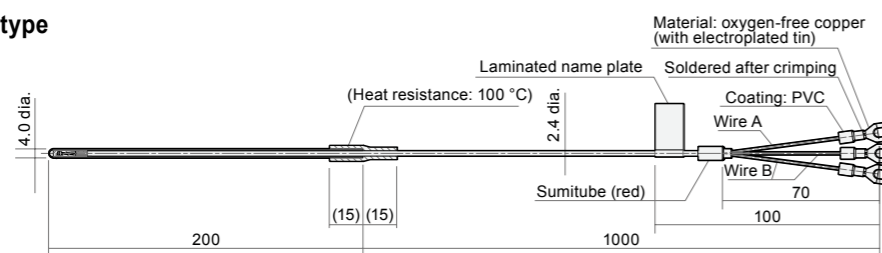

### 6 mm dia. type

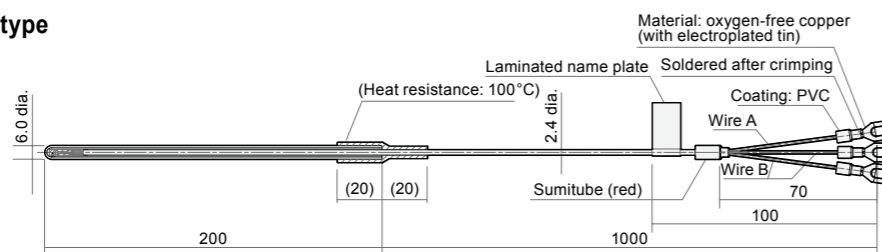

## Customizing service

We offer customized cables with protection tube lengths of 100 to 1000 mm and lead lengths of 1 to 10 m. Please contact a sales representative for details.

# Chemical-resistant fiber-optic sensors

Model HPF-T029/HPF-T035/HPF-D014

Simply cut the PFA-jacketed cable to length and insert as is into the amplifier.\*

Bend radius of R20mm with 2.2mm tube diameter\*

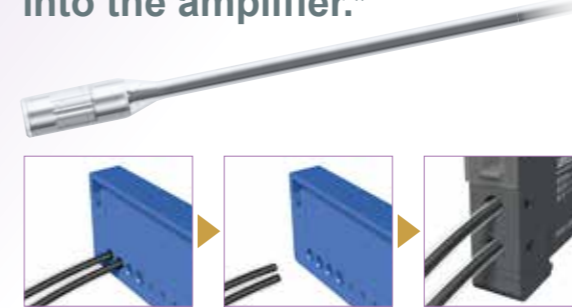

\*Model HPF-D014 is excluded.

Inherently safe product PFA protection Cable R20 2m Free Cut

## SPECIFICATIONS

### Thru scan

Type	Size	Shape	Cable		Scanning distance (mm)		Core (mm)	Catalog listing	
			Bend radius	Length	Amp	Mode			Distance
Top	4.7 mm dia.	Shape A	R20	2m	HPX-EG	nL	1,500	0.1 dia.	HPF-T029
						FT	880		
Top	4.7 mm dia.	Shape B	R20	2m	HPX-EG	nL	280	0.1 dia.	HPF-T029E
						FT	160		
Side	4.7 mm dia.	Shape C	R20	2m	HPX-EG	nL	350	0.1 dia.	HPF-T035
						FT	210		

### Diffuse scan

Type	Size	Shape	PFA area	Cable area	Length	Amp	Mode	Core (mm)	Catalog listing
Top	6 mm dia.	Shape D	R80	R20	2m	HPX-EG	nL	70	HPF-D014
							FT	42	

Note: • Scanning distances for diffuse scan are obtained with a standard target object (plain white paper).  
 • Response times for the sensing types: HP 5 ms, nL 1 ms, and FT 250 μs.  
 • For chemical resistance of fluorine-resin, see the Technical Guide (page 26).  
 • The values shown in the Minimum detectable size column were obtained with optimal scanning distance and sensitivity settings (HPX-AG).

## EXTERNAL DIMENSIONS

Unit: mm

### Model HPF-T029

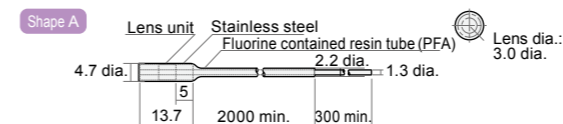

### Model HPF-T029E

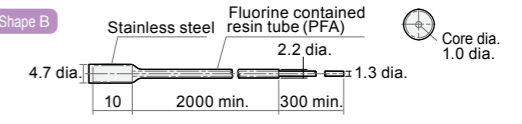

### Model HPF-T035

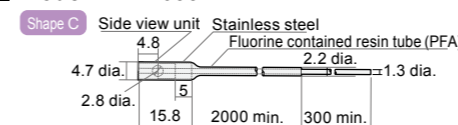

### Model HPF-D014

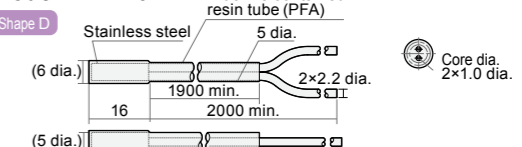

# Micro flow rate liquid flow meter

Model F7M

Thermal micro flow rate liquid flow meter, achieving high-functionality measurement and usability



Measurement range 10 mL/min FL7M9010	Measurement range 30 mL/min FL7M9030	Measurement range 50 mL/min FL7M9050	Straight flow path
--	--	--	--------------------

## Features & Merits of the F7M

Combining a thermal MEMS sensor that is commonly used for gas flow meters and a flow path that is made of highly corrosion-resistant fused quartz glass, the product can measure both instantaneous and totalized flow value of micro flow rates of several mL/min, which is difficult to do with a high degree of reproducibility using traditional measurement methods. Compared with conventional methods, the measurement method used by this new product is less susceptible to changes in the fluid state (e.g., bubbles, pulsations, and fluid temperature) (although it may be necessary to change the settings parameters), and micro flow rates can be measured easily. Measuring the flow rates allows for more reliable data management by replacing alternative measures, such as managing the pump rotation speed, measuring the weight, and managing the fluid supply time. In addition, with the event functions it is possible to detect empty pipes and the presence of bubbles, and to monitor the status of pulsation.

### Measures 30 mL/min or lower

Features the thermal measurement principle using MEMS sensing technology. Measuring micro flow rates of several mL/min, which traditionally has been difficult, is now possible. (Measurement range: 0.1 to 10 mL/min, 0.3 to 30mL/min)

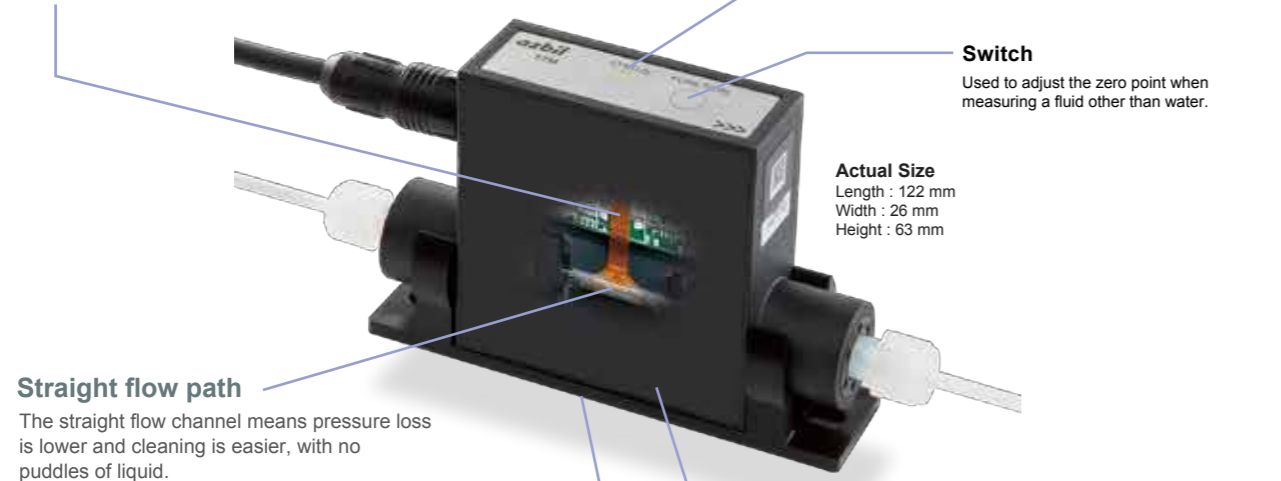

### Compact, light-weight, and easy to install

- This model is more compact and lighter than its predecessors.
- By using the included mounting bracket, it can be easily installed on a surface (for horizontal pipe connection).
- It can also be installed for vertical pipe connection.
- A separate converter (amplifier) is not required.

### Flexible installation and wide range of fluids

- Compliant with IP65 protection rating.
- Exterior contains no metal, providing improved resistance to corrosive fluids, allowing use in environments with liquid spray.
- Can be used for a variety of fluids, so long as they do not corrode fused quartz glass (the material of the flow path) or fluororesin (the material of the fitting). The sensor does not come into contact with any fluids.

## DETECTION PRINCIPLE

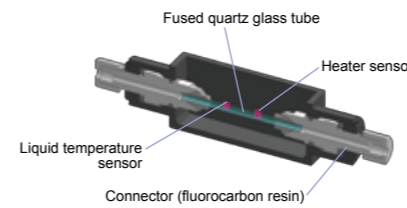

- Heater surface temperature is constantly controlled to keep it at a fixed value that is slightly higher than the fluid temperature.
- Heat dissipation from the heater changes depending on the flow rate.
- As the flow rate rises, the amount of heat transferred to the fluid increases, and the power consumption of the heater increases.
- By measuring the heater's power consumption, the flow rate can be calculated. (Heat dissipation from the heater is quite small that it does not heat the fluid.)

## Output Characteristics Before and After Correction

The measurable range varies according to the thermal conductivity of the fluid, but the output characteristics can be adjusted by using the correction function. (See the conceptual diagrams below.) For correction factor setting is necessary to use SLP-F7M Smart Loader Package for F7M.

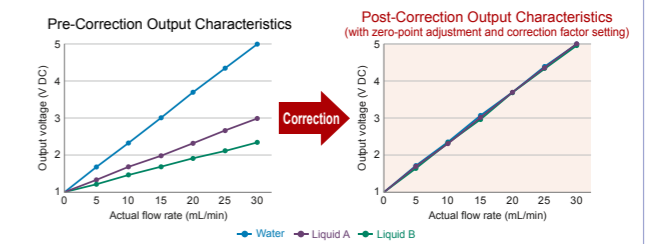

## SPECIFICATIONS

Catalog listing	F7M9010	F7M9030	FL7M9050
Measurable flow rate range (for water (H <sub>2</sub> O))	0.1 to 10 mL/min	0.3 to 30 mL/min	0.5 to 50 mL/min
Measurement accuracy	±5 % rdg. (at 20 % or more of the flow rate range), ±1 % FS (at less than 20 % of the range) The instrumental error in the volumetric flow rate was measured by Azbil's fluid flow rate calibration equipment under standard conditions*1		
Repeatability	±1 % rdg. (at 20 % or more of the flow rate range), ±0.2 % FS (at less than 20 % of the range) Instrumental error discrepancies in the volumetric flow rate measured by Azbil's fluid flow rate calibration equipment under standard conditions*1		
Measurable fluid	Fluid that does not clog the flow path and does not corrode or damage the fused silica glass tube or the PFA fitting used in the flow path. The measurement range differs for fluids other than water (H <sub>2</sub> O).		
Accuracy- and repeatability-guaranteed fluid	Water (H <sub>2</sub> O)		
Accuracy- and repeatability-guaranteed flow rate range (for water (H <sub>2</sub> O))	0.2 to 10 mL/min	0.6 to 30 mL/min	1.0 to 50 mL/min
Temperature characteristic (where the fluid and ambient temperatures are the same)	Where the fluid and ambient temperatures are the same and within 10 to 35 °C Within 0.5 % rdg. / °C of the output value under standard conditions*1		
Fluid temperature range (operation-guaranteed range)	5 to 50 °C (without freezing)		
Ambient temperature range (operation-guaranteed range)	5 to 50 °C (without condensation or freezing) (5 to 60 °C at transportation and storage)		
Ambient humidity (operation-guaranteed range)	10 to 90 % RH (without condensation)		
Process fluid pressure range	0 to 500 kPa		
Pressure resistance	700 kPa		
Mounting orientation	Horizontal or vertical (flow direction: bottom to top)*2		
Straight pipe length	50 mm (for water (H <sub>2</sub> O))		
Fitting pullout strength	30 N		
Drive power voltage	24 Vdc ± 10 %, 0.7 W max.		
Output signal	Instantaneous flow rate output: 1 to 5 Vdc*3 (1 output) (External load resistance: 250 kΩ min. Maximum output voltage: 5.6 V) External contact output (open collector): event output or totalized flow pulse*4, 30 Vdc, 30 mA max. (1 output)		
External contact input	1 Non-voltage contacts or open collector Allowable ON resistance: 250 Ω max. Allowable OFF resistance: 100 kΩ min. Allowable ON residual voltage: 0.8 V max. ON terminal current: 0.5 mA (when contact resistance is 250 Ω)		
Weight	85 g (including the mounting bracket but excluding the cable)		
Protection rating	IP65		
Noise immunity	EN61326-1, EN61326-2-3		

For details on the product specifications, refer to the user's manual (CP-SP-1421E).

\*1. "Standard conditions" means that both the ambient and fluid temperatures are 23 °C. Please contact us for other conditions.

\*2. For vertical mounting, there is an output shift of about ± 1 % rdg. in measurements when compared with horizontal mounting.

\*3. If the flow rate is below the lowest measurable rate, the output signal is always 0 % (1 V). Up to 115 % (5.6 V) of the highest measurable flow rate can be output.

\*4. A dedicated PC loader is required to change parameter settings.

## EXTERNAL DIMENSIONS

Unit: mm

### Model F7M

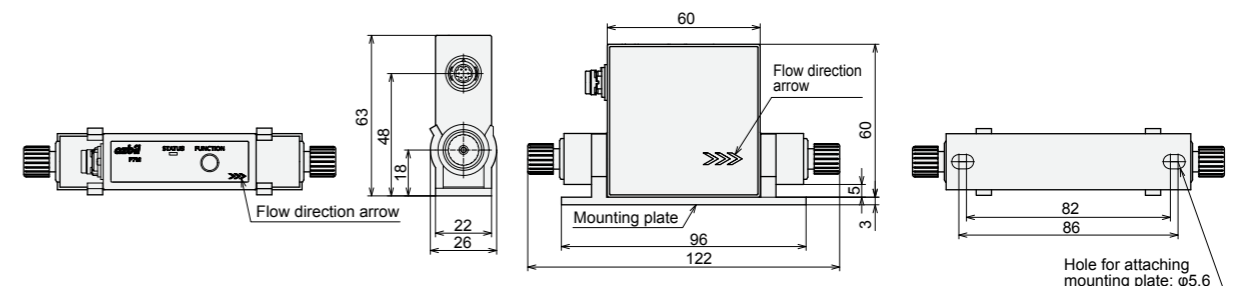

\*1. Mounting screws are not included (specification: screw head height of 5 mm max.).

## PRECAUTIONS FOR HANDLING (Installation)

### Model HPF-T032/T034

#### Mounting method

- As shown below, mount the fiber unit using the included cable ties and anti-slip tubes. Firmly tighten the two upper and lower cable ties and then cut off any extra length.
- If an additional cable tie is required, use one no more than 2.5mm wide. Recommended pipe material is PFA, 1mm thick. For pipe diameter, see information on HPX-T032/T034 in this brochure.

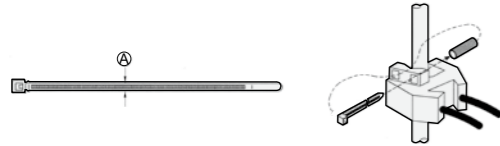

### Model HPQ-D1\_/HPQ-D2\_

#### Installation

- Install this switch on a horizontal surface. After attaching the mounting base, insert the switch into the mounting base and push the support lever on the body down to fix the switch.
- Screw mounting  
In the case of a PVC mounting base, punch out the knockout holes in the base, put two stud bolts with M4 thread that are stud-welded to a stainless steel (etc.) metal pan through the holes, and secure the switch with two M4 nuts. For a PFA mounting base, install in the same manner but with a single M3 stud bolt.
- Mounting with adhesive  
The PVC type bracket can also be adhesive-mounted. If the surface on which the switch will be mounted is made of PVC (polyvinyl chloride), which is the same material as the mounting base, we recommend a monomer-based adhesive. However, regardless of the type of surface material, be sure to check the specifications of the adhesive to make sure that it is appropriate.

\* For use in explosive atmosphere  
Since this product is not an explosion-proof type, it cannot be used in an explosive atmosphere.

#### Model HPQ-D1\_

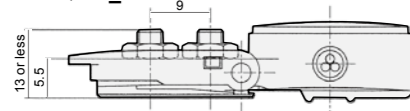

#### Model HPQ-D2\_

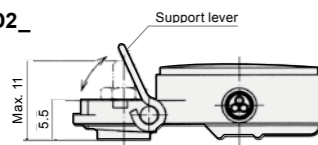

Unit: mm

### Model HPQ-DP

#### Mounting method

- Attaching the mounting base  
Use two M4 screws or stud bolts to fix the mounting base so that it does not wobble. The recommended tightening torque is 0.5 N·m or less.
- Mounting the switch on the base  
Align the square hole in the mounting part of the switch with the protrusion in the mounting base, and push the switch until the detector head in the center of the switch casing makes contact with the surface where leakage is to be detected.
- Removing the switch from the mounting base  
While squeezing the mounting base at both ends with one hand, grasp the mounting part of the switch casing with the other hand and pull the detector up to remove it. For details, refer to the instruction manual.

### Model HPF-D040

#### Mounting method

- When using an SUS mounting base, insert the welded M3 stud bolt into the hole of the mounting base, and then fasten with an M3 nut (not supplied).
- Put the ridges of the dedicated mounting base into the grooves of the fiber-optic switch, and then slide the base forward until it is in place.
- Precaution for use in explosive atmospheres  
The fiber unit can be used in a hazardous location if the amplifier unit is installed in a non-hazardous location. However, before using the switch, carefully check the explosion-proof regulations required for the facility and the equipment.

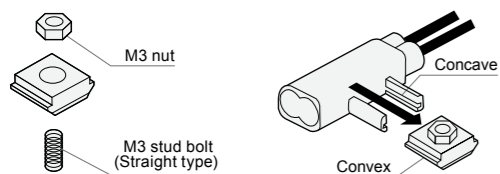

### Model HPQ-T1/HPQ-T2

#### Mounting method

- The HPQ-T is pipe-mounted using either an M3 screw or cable tie. When mounting the switch with a cable tie, be sure to secure the switch by passing the cable tie through silicone tube to prevent the switch from slipping. Sensitivity adjustment is not required.

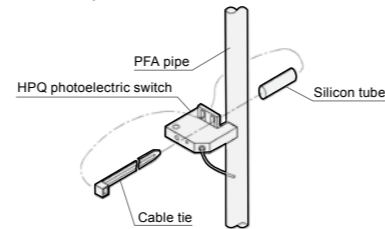

### Model HPF-D027/HPF-D033

#### Mounting method

- To install the fiber-optic sensor, use a commercially available fluorine-rein joint that matches the outside diameter of the PFA tube.

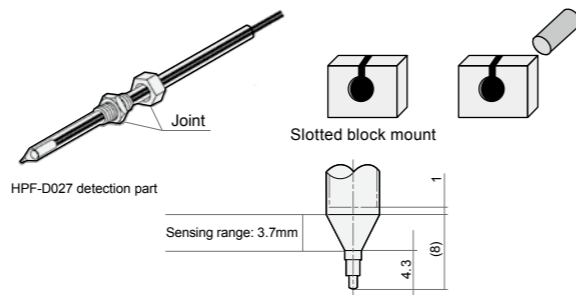

The level at which liquid is detected differs according to surface tension and leakage situation where the fiber unit is located.

- The following may cause unstable sensing:
  - 1) Bubbles on conical portion of sensing head.
  - 2) Chemical precipitate on conical portion of sensing head.
  - 3) High density liquid-Some liquid properties, such as milky white color, may be undetectable.
- Do not scratch or deform the fiber unit tip. Doing so may cause unstable sensing. Protect it (esp. the conical part) from impact.
- In case dripping causes output chattering, use a timer.

### Model HPF-T029/HPF-T035/HPF-D014

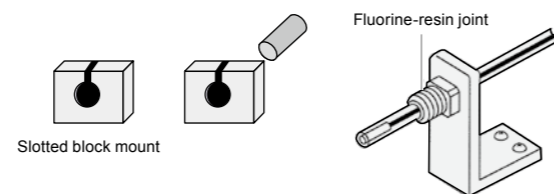

#### Mounting method

- To install the fiber-optic switch, use a commercially available fluorine-resin joint that matches the outside diameter of the PFA tube.
- The bend radius of the protective tube must be more than the minimum bend radius specified for each fiber unit. If it is less than the minimum bend radius, it may damage the fiber unit.
- Do not apply excessive tension to the fiber-optic cable.

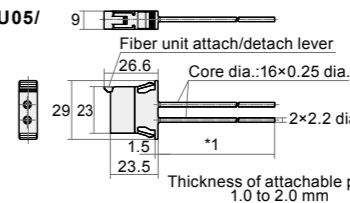

Before use, thoroughly read the instruction manual and product specification for this switch.

## Characteristics of Scanning Distance by Combination with Fiber Extender (typical values)

		Unit: mm							
	Model HPF-EU05/ HPF-EU10	 <p>Fiber unit attach/detach lever Core dia.: 16×0.25 dia. Thickness of attachable plate: 1.0 to 2.0 mm</p>	<table border="1"> <thead> <tr> <th>Catalog listing</th> <th>Cable length*1</th> </tr> </thead> <tbody> <tr> <td>HPF-EU05</td> <td>5000mm min.</td> </tr> <tr> <td>HPF-EU10</td> <td>10000mm min.</td> </tr> </tbody> </table>	Catalog listing	Cable length*1	HPF-EU05	5000mm min.	HPF-EU10	10000mm min.
	Catalog listing	Cable length*1							
	HPF-EU05	5000mm min.							
HPF-EU10	10000mm min.								
Product name	Shape	Description	Other specifications	Catalog listing					
Fiber-optic extender		Use to extend fibers by linking them.	Cable length: 5 m. Bend: 4 mm in radius <span style="background-color: #e0f0ff; padding: 2px;">Free cut</span> Cable length: 10 m. Bend: 4 mm in radius <span style="background-color: #e0f0ff; padding: 2px;">Free cut</span>	HPF-EU05  HPF-EU10					

## PFA Chemical Proof

Substance	PFA chemical proof
Heavy oils A/B/C	OK
Aniline	C <sub>6</sub> H <sub>5</sub> NH <sub>2</sub> OK
Acrylonitrile	C <sub>2</sub> H <sub>3</sub> CN OK
Asphalt	OK
Acetone	(CH <sub>3</sub> ) <sub>2</sub> CO OK
Methanol	CH <sub>3</sub> OH OK
Ammonia	NH <sub>3</sub> OK
Isocetane	i-C <sub>8</sub> H <sub>18</sub> OK
Isobutyl alcohol	i-C <sub>4</sub> H <sub>9</sub> OH OK
Isobutyl methyl ketone	C <sub>4</sub> H <sub>9</sub> COCH <sub>3</sub> OK
Ethanol	C <sub>2</sub> H <sub>5</sub> OH OK
Ether	(CH <sub>3</sub> ) <sub>2</sub> O OK
Ethylene glycol	C <sub>2</sub> H <sub>4</sub> (OH) <sub>2</sub> OK
Enamel paint	OK
Ammonium chloride	NH <sub>4</sub> Cl OK
Calcium chloride	CaCl <sub>2</sub> OK
Sodium chloride	NaCl OK
Barium chloride	BaCl <sub>2</sub> OK
Chlorine	Cl <sub>2</sub> OK
Gasoline	OK
Glass ingredients	OK
Dilute hydrochloric acid	HCl OK
Dilute sodium hydroxide	NaOH OK
Dilute acetic acid	CH <sub>3</sub> COOH OK
Dilute nitric acid	HNO <sub>3</sub> OK
Dilute sulfuric acid	H <sub>2</sub> SO <sub>4</sub> OK
Citric acid	C <sub>3</sub> H <sub>4</sub> (OH)COOH) <sub>3</sub> OK
Glycerin	C <sub>3</sub> H <sub>5</sub> (OH) <sub>3</sub> OK
Cresol	C <sub>6</sub> H <sub>4</sub> (OH)(CH <sub>3</sub> ) OK
Chloroform	CH <sub>3</sub> Cl OK

Substance	PFA chemical proof
Light oil	OK
Paraffinum liquidum	OK
Sodium dichromate	Na <sub>2</sub> Cr <sub>2</sub> O <sub>7</sub> OK
Barium nitrate	Ba(NO <sub>3</sub> ) <sub>2</sub> OK
Silicone oil	OK
Plant oil	OK
Thinner	OK
Barium hydroxide	Ba(OH) <sub>2</sub> OK
Phenol	C <sub>6</sub> H <sub>5</sub> OH OK
Turbine oil	OK
Sodium carbonate	Na <sub>2</sub> CO <sub>3</sub> OK
Turpentine	OK
Natural volatile oil	OK
Kerosine petroleum	OK
Trichloroethane	C <sub>2</sub> H <sub>3</sub> Cl <sub>3</sub> OK
Trichlorethylene	C <sub>2</sub> HCl <sub>3</sub> OK
Toluene	C <sub>6</sub> H <sub>5</sub> CH <sub>3</sub> OK
Naphtha	C <sub>7</sub> H <sub>16</sub> OK
Acidum lacticum	OK
Nitrobenzene	C <sub>6</sub> H <sub>5</sub> NO <sub>2</sub> OK
Hydrofluoric acid (hydrogen fluoride)	HF *
Ferrosilicon	OK
Freon 11	CCl <sub>3</sub> F OK
Propyl alcohol	C <sub>3</sub> H <sub>7</sub> (OH) <sub>3</sub> OK
Propylene glycol	C <sub>3</sub> H <sub>2</sub> (OH) <sub>2</sub> OK
Benzene	C <sub>6</sub> H <sub>6</sub> OK
Methyl violet	OK
Water	H <sub>2</sub> O OK
Carbon tetrachloride	CCl <sub>4</sub> OK
Ammonium sulfate	(NH <sub>4</sub> ) <sub>2</sub> SO <sub>4</sub> OK

Additional Notes  
 •The above table is not a guarantee that the product can be used with the indicated substance.  
 •Substances such as strong acids and ammonia may penetrate PFA (fluororesin).

## GLOBAL STANDARDS AND APPROVALS

### International standards

International standards, including safety standards, are established by two international organizations: the IEC for electricity and the ISO for other fields.

#### 1. IEC (International Electrotechnical Commission)

The IEC is an international organization that was founded in October 1908 following discussions that began at the International Electrical Congress in 1881.

It has its headquarters in Geneva, Switzerland and works for unification and coordination of international standards relating to electricity. Today, more than 80 countries, representing 80% of the world's population, including the world's leading industrialized countries (which produce 95% of electric energy globally), have joined the IEC.

The organization issues standards for the latest electrical technologies based on discussions between representatives of participating countries, which have signed an international agreement to develop national standards based on the IEC standards.

#### 2. ISO (International Organization For Standardization)

The ISO started activities in 1947 and has its headquarters in Geneva, Switzerland.

The organization works for standardization in fields other than the electrical field and has about 90 participating countries. Japan has joined the ISO since 1952.

The ISO 9000 (quality management system) family of standards and ISO 14000 (environmental management system) family of standards are well known in Japan.

### UL standards (region: United States of America)

#### 1. About UL standards

In the United States, since states and local governments have the right to make safety regulations, some safety regulations are locally adopted, as in the case of principal cities such as New York, Los Angeles, Chicago, and San Francisco. However, since in almost all locations, approval is required not only locally but also at the state and federal level, manufacturers generally obtain UL certification instead of verifying product safety to individual state or local government authorities. Additionally, in recent years, due to increased communication with the Canadian Standards Association (CSA), there is a movement to harmonize UL and CSA standards.

#### 2. About UL

UL (Underwriters Laboratories Inc.) is a private nonprofit organization that promotes public safety by protecting human life and property from fires and other accidents. Its scope of operations includes testing, studying, inspection, and certification. UL was organized as a result of fires that occurred at the Columbia Exhibition held in Chicago in 1893. The cause of the fires was the large number of electric lamps, the newest Edison lamps at that time, used for lighting. Afterwards too, fires occurred frequently in major cities, and their cause was almost always new outlets or electric devices that were used without having been tested. The accidents were a cause of concern in the insurance business, and a dedicated investigative group was organized, followed by the Underwriters Electrical Bureau, a nonprofit organization and the predecessor of UL, in 1894. This became Underwriters Laboratories Inc. in 1901. Since then its function has expanded to areas other than electricity.

Although UL does not have any administrative power, it is the top authority for safety testing and product certification in the U.S., based on its extensive experience and ability to issue product safety certification. UL is also approved by the SCC (Standards Council of Canada) as a testing and certification organization. Therefore, UL conducts evaluation of products to be shipped to Canada in accordance with CSA standards and regulations, and can give approval to apply a special UL mark, cUL, for Canada. The cUL mark is formally approved throughout Canada.

#### 3. UL mark (for shipment to the U.S.)

Listing mark



This mark certifies that samples of independently functioning final products have been tested by UL and comply with the applicable UL standards.

cUL listing mark



This mark is used for independently functioning final products that are to be shipped to Canada. It certifies that the products have been tested by UL based on Canada's CSA standards.

cUL US listing mark



This new listing mark was introduced in 1998 to certify that products comply with the safety requirements of both Canada and the U.S.

Recognized component mark



This mark recognizes that samples of a part that does not function independently, or a part with limited functions, have been tested by UL and comply with the applicable UL standards.

\* Even if parts with this recognized component mark are used in the final product, the final product cannot be listed as UL-approved on that basis alone.

Recognized component mark for shipment to Canada



This mark is used for parts/materials (components) for shipment to the Canadian market. It certifies that the products have been verified by UL to satisfy Canada's safety requirements.

Recognized component mark for shipment to the U.S. and Canada



This mark is used for parts/materials (components) that comply with the safety requirements of both Canada and the U.S.

FM standards (region: United States of America)



FM stands for the Factory Mutual Insurance Company. It is a private insurance company founded in 1835 to provide insurance for factories and commercial facilities. In addition to insurance services, it provides risk management services for factories and commercial facilities, developing business not only in North America but also in South America, Europe, the Middle East, Africa, and the Asia-Pacific region.

An affiliated company, FM Approvals, is a third-party certification body that offers certification and testing services for products for industrial and commercial property loss prevention. It grants FM Approval to products that have been tested to comply with the requirements of FM standards.

CSA standards (region: Canada)

#### 1. About CSA standards

The Standards Council of Canada (SCC) coordinates standardization and establishes independent national standards. Actual production of standards is entrusted to various standards organizations. At present, six organizations produce Canadian national standards on behalf of the SCC. One of these is the CSA, which produces CSA standards.

Although CSA standards are nonbinding, in some cases they are applied by federal or state law. The CSA strives to protect human life and property, and it produces important safety standards.

#### 2. About the CSA

The CSA (Canadian Standards Association) is an independent non-governmental, non-profit organization. As the largest Canadian standards-establishing organization, the CSA provides services for standards compliance certification not only by developing and establishing standards, but also by evaluating products. In addition, the CSA participates in the activities of international organizations, such as the ISO and IEC, as a representative of Canada.

### 3. CSA mark

CSA mark for use in Canada



This mark certifies that the product has been verified by the CSA to satisfy Canadian standards as a product for the Canadian market.

CSA mark for use in Canada and the U.S.



This mark certifies that the product has been verified by the CSA to satisfy both Canadian standards and U.S. standards as a product for the Canadian and U.S. markets.

### European standards (EN standards)

#### 1. About CE marking

CE mark



In order to make the best use of the advantages obtained by European unification, the European Union (EU) Commission modified the safety regulations in the EU area to produce unified regulations by product category, such as machinery, toys, and medical devices. This was done in the European Communities Directive (EC Directive) officially announced in 1989. Documents such as the Machine Directive, EMC Directive (regulations on the compatibility of electromagnetic waves generated by electrical products), Low Voltage Directive, and Medical Device Directive were issued. At the same time, the system of granting CE marking by product category began.

\* The EC Directives most directly relevant to Azbil's products are the Low Voltage Directive and the EMC Directive. The Machinery Directive is also relevant indirectly.

#### 2. About EN standards

EC directives such as those mentioned above are laws that must be observed. However, they contain only basic requirements written in general terms, resulting in difficulty in concrete understanding. Therefore, many manufacturers now design products based on what are known as EN standards.

In parallel with unifying the regulations (EC directives) in the EU area, the industrial standards and safety standards of each country are also being unified. This unification of standards is being carried out by two non-governmental, non-profit organizations, the European Committee for Standardization (CEN) and the European Committee for Electrotechnical Standardization (CENELEC). Unified standards are assigned numbers beginning with letters EN (European Norm) and are called EN standards. EN standards assist in concrete product design by giving numerical values and drawings pertaining to the safety requirements of EC directives.

#### About VDE

VDE stands for the Association for Electrical, Electronic and Information Technologies. It provides testing and certification services to ensure safety of electrical products under EN and other standards.

#### SIL

SIL (safety integrity level) is a measure of the performance of a safety function provided by a control system as defined in IEC 61508. There are four safety integrity levels, SIL1 through SIL4, where SIL4 indicates the highest level of safety function performance and SIL1 indicates the lowest. The required level varies depending on the severity and likelihood of a hazardous event.

#### Performance Level (PL)

This is an indicator of the performance of safety-related parts of control systems as defined in ISO 13849-1. There are five performance levels, PL a through PL e. The required level is determined by comprehensively considering the severity of harm, the frequency and duration of exposure to a hazard, and the probability of avoiding or limiting harm.

### TÜV standards (region: Germany)



TÜVs are civil inspection organizations in Germany. On behalf of the government, they inspect electric equipment, machines, automobiles, medical equipment,

sporting goods and toys, boilers and other products and certify their compliance with EN and other standards. There are 14 TÜVs (such as TÜV Rheinland) in Germany operating as independent companies.

### GB standards (region: China)

#### 1. About the CCC mark

CCC mark



Following China's accession to the World Trade Organization (WTO) in 2001, a new safety certification system was established by the Certification and Accreditation Administration of the People's Republic of China (CNCA) in order to produce uniformity and consistency in commodities requiring certification, in standards, technical regulations, testing procedures, certification marking, and certification fees. This new system is called China Compulsory Certification (CCC). Whether a product is subject to CCC is determined by the GB Standards (Guojia Biaozhun, or Chinese National Standards) and by the product's HS code (Harmonized Commodity Description and Coding System).

#### 2. About GB standards

The Chinese National Standards (GB Standards) are based on IEC Standards. The range of items subject to CCC was announced by the CNCA on July 1, 2002, categorized by HS codes, commodity descriptions and comments, and certification scopes. A product with an HS code that is not among those subject to CCC does not need a CCC mark. Even if the HS code is on the list, however, the product might not be subject to the GB Standards. Therefore, obtaining CCC marking is required only if both the HS code and GB standards are applicable.

\* HS coding is an international system specified by the WTO for classifying export and import goods. In countries applying HS coding, the first 6 digits of the HS code use a standard system, and the remaining digits from 7 on are optionally used by each country. The HS code has two roles. By providing a uniform categorization of goods, it facilitates statistics measuring international trade transactions using a common scale. Second, it functions as a customs tariff table, with the tariff amount determined by each country.

### S-mark (region: Korea)

#### 1. About the S-mark

S-mark



The S-mark is a voluntary certification system established in November 1997 by the Korea Occupational Safety and Health Agency (KOSHA) to reduce occupational accidents. The S-mark is granted for products that have been examined by KOSHA and are deemed to satisfy standards based on Article 34-2 of the Occupational Safety and Health Act for product safety, product reliability, and the quality control capabilities of the manufacturer.

#### 2. About KOSHA

KOSHA was founded in 1987 under the Korea Occupational Safety and Health Agency Law. KOSHA engages in research, development and dissemination of occupational accident prevention techniques, gives guidance and training about occupational safety and health techniques, and inspects machines with potential hazards to promote the health and safety of workers and to encourage employers to take accident prevention measures.

### Radio Waves Act (KC mark) (region: Korea)

KC mark (Korea certification mark)



Products such as computers, peripherals, and communication equipment require the KC mark under the Electrical Appliances Safety Control Act, the Radio Waves Act, and the Framework Act on Telecommunications. EMC (electromagnetic compatibility) testing became mandatory for radio equipment on July 1, 2011, and safety testing became mandatory for radio equipment and all information processing equipment on January 1, 2012.

### WHG certificate (region: Germany and part of Benelux)



WHG (Wasserhaushaltgesetz), Water Resource Act, is a German law which provides the legal basis for the protection of surface water and ground water. WHG prescribes overflow prevention for containers of water polluting liquids. The product is inspected by TÜV NORD CERT and approved by DIBt (Deutsches Institute für Bautechnik) according to WHG regulations.