

rotork®

Controls

CVQ Series

Installation & Maintenance Instructions

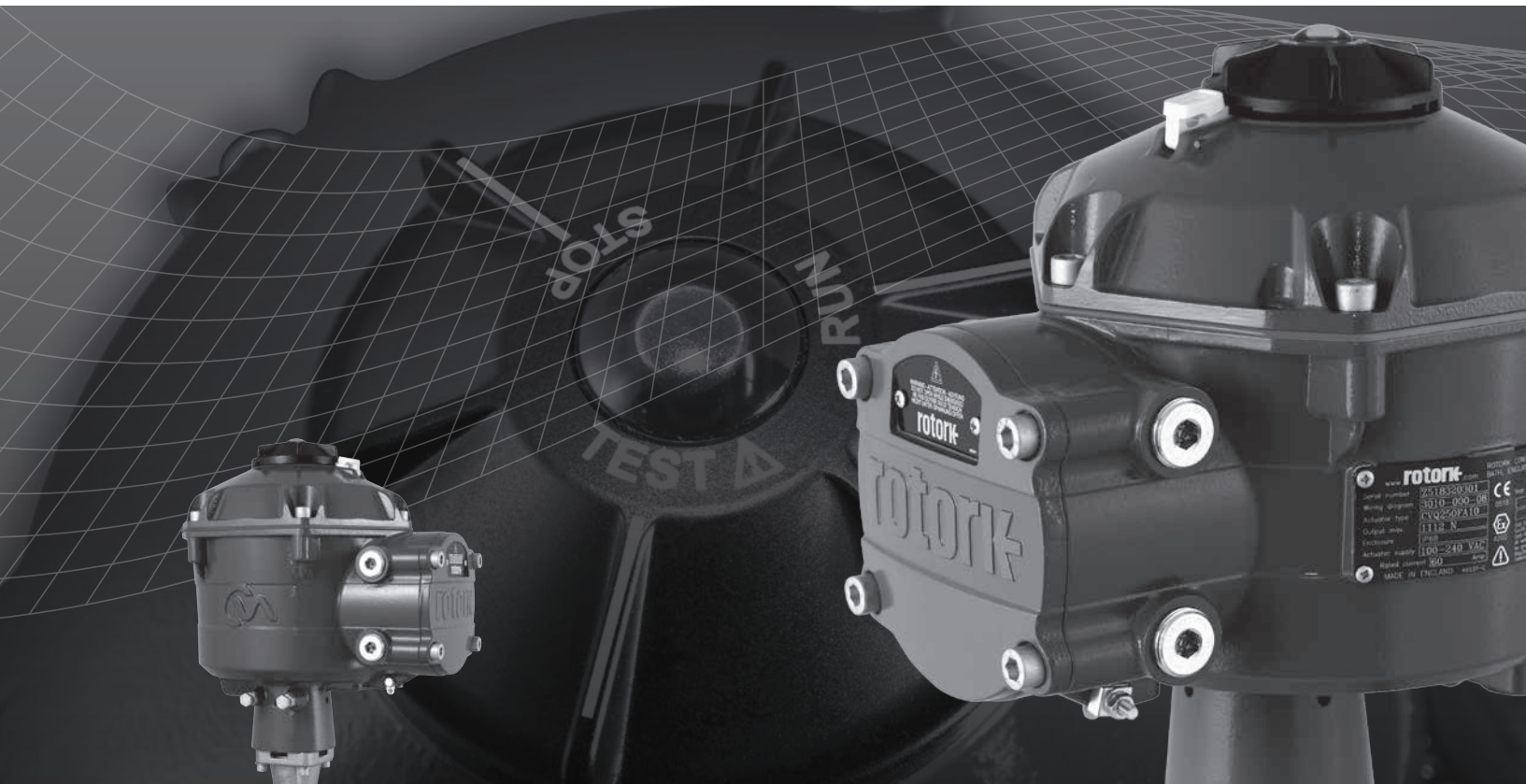

Quarter-turn Control Valve Actuator

Keeping the World Flowing

Contents

1.0	Introduction	3	7.9	Fitting Actuator to Valve	20
2.0	General Information	4	7.10	Align Coupling - Adjust Stop Bolts	22
2.1	Enclosure Materials	4	7.11	Quick Setup Wizard	25
3.0	Hazardous Area Approvals	5	7.12	Manual Setup Flow Chart	30
4.0	Health & Safety	7	7.13	Manual Setup	31
5.0	Storage	7	7.14	Configurations Options Setup Flow Chart	35
5.1	Receiving/Inspection	7	7.15	File	36
5.2	Storage	7	7.16	Macro Update	38
5.3	Identification Label	7	7.17	Setup	38
6.0	Operating your Actuator	8	7.18	Control	38
6.1	Local Controls	9	7.19	Valve Actions	39
6.2	Reserve Power Pack	11	7.20	Input/Output Setup	40
7.0	Installation & Setup Guide	12	7.21	Fail Modes	41
7.1	Commissioning	12	7.22	Advanced 1	42
7.2	Quick Setup Flow Chart	13	7.23	Advanced 2	44
7.3	Mounting the Actuator	14	7.24	Characterisation	45
7.4	Cable Connections	16	7.25	RIRO (Remote Inputs & Remote Outputs)	47
7.5	Commissioning	18	7.26	Change Password	49
7.6	Reconnect or Discover an Actuator	19	7.27	Control & Diagnostics Options Setup Flow Chart	50
7.7	Login	19	7.28	Diagnostic Menus	53
7.8	Stroke Setup Menu	20	8.0	Rotork Sales and Service	58



THIS MANUAL CONTAINS IMPORTANT SAFETY INFORMATION. PLEASE ENSURE IT IS THOROUGHLY READ AND UNDERSTOOD BEFORE INSTALLING, OPERATING OR MAINTAINING THE EQUIPMENT.

1.0 Introduction

This manual covers the quarter-turn control valve actuator range (CVQ).

Models: CVQ 1200 & CVQ 2400

Refer to Rotork PUB042-001 for full specification.

Building on Rotork's historical success with innovative technology, the CVQ offers a highly accurate and responsive method of automating control valves without the complexity and cost of a pneumatic supply. With an increased focus on production costs and efficiency, accurate control of the process variable is paramount.

With resolution figures better than 0.1% and the ability to eliminate position overshoot, the Rotork CVA range helps to maximize product quality and plant capacity.

CVA range actuators are self contained, purpose designed and built for continuous remote electrical operation of control valves.

The actuator comprises:

- DC brushless electric motor
- Reduction gearing with quadrant output gear
- Motor controller with speed, travel and torque limitation
- Electronic logic controls and monitoring facilities housed in a double-sealed watertight enclosure
- Hazardous area certification meeting international and national requirements

All torque and position settings as well as configuration of the actuator are made using a non-intrusive *Bluetooth*[®] wireless device, typically a PDA (not supplied).

Bluetooth[®] PDA software is available for free download from www.rotork.com.

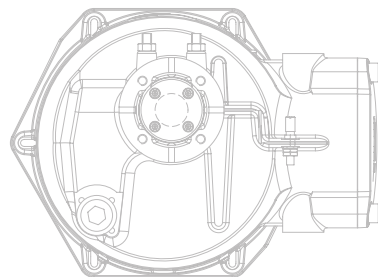
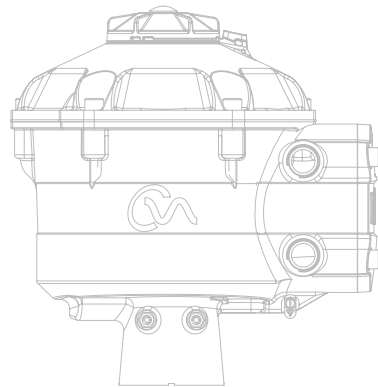

2.0 General Information

This manual has been produced to enable a competent user to install, operate, adjust and inspect the Rotork range of Control Valve Actuators.

The electrical installation, maintenance and use of these actuators should be carried out in accordance with the National Legislation and Statutory Provisions relating to the safe use of this equipment applicable to the site of installation.

For the UK: Electricity at Work Regulations 1989 and the guidance given in the applicable edition of the 'IEE Wiring Regulations' should be applied. Also the user should be fully aware of their duties under the Health and Safety at Work Act 1974.

For the USA: NFPA70, National Electrical Code® is applicable.

The mechanical installation should be carried out as outlined in this manual and also in accordance with any relevant national standard codes of practice. If the actuator nameplate indicates that it is suitable for use in a Potentially Explosive Atmospheres (Hazardous Areas) then the actuator is suitable for use in Zone 1 and Zone 2 (or Div 1 and Div 2) hazardous area classifications, as defined by the actuator's nameplate marking.

Any equipment connected to the actuator should be of an equivalent (or better) hazardous area certification. The installation, maintenance and use of the actuator installed in a hazardous area must be carried out by a competent person and in accordance with all relevant codes of practice for the particular Hazardous Area certification.

Any inspection or repair of Hazardous Area approved actuators should not be undertaken unless it conforms to National Legislation and Statutory Provisions relating to the specific Hazardous Area.

Only Rotork approved actuator replacement parts should be used. Under no circumstances should any modification or alteration be carried out on the actuator, as this could invalidate the conditions under which its certification was granted.

Access to live electrical conductors is forbidden in a Hazardous Area unless it is done under a special permit to work, otherwise all power should be isolated and the actuator moved to a non-hazardous area for repair or attention.

Only persons competent by virtue of their training or experience should be allowed to install, maintain and repair Rotork actuators. Work undertaken must be carried out in accordance with instructions in the manual. The user and those persons working on this equipment should be familiar with their responsibilities under any statutory provisions relating to the Health and Safety of their workplace.

2.1 Enclosure Materials

The enclosures on the Rotork range of Control Valve Actuators are manufactured from aluminium alloy with stainless steel fasteners and a polycarbonate window. The Local Control Knob and Manual Override Knob (when fitted) are manufactured from a Polycarbonate/PBT plastic blend. There is a potential electrostatic charging hazard associated with these components and therefore they must only be cleaned with a damp cloth.

The user must ensure that the operating environment and any materials surrounding the actuator cannot lead to a reduction in the safe use of, or the protection afforded by, the actuator. Where appropriate the user must ensure the actuator is suitably protected against its operating environment.

Should further information and guidance relating to the safe use of the Rotork Control Valve Actuator range be required, it will be provided on request.



3.0 Hazardous Area Approvals

Refer to the actuator nameplate for its specific approval details.

The CVQ is built in accordance with: -

European – Hazardous Area ATEX (94/9/EC) II 2 GD c OR II 2 (1) GD c (For Intrinsically Safe option)

Ex d IIB T4 Gb, Ex t IIIC T120°C Db

Ex d [ia Ga] IIB T4 Gb (For Intrinsically Safe option)
Ex t [ia IIIC Da] IIIC T120°C Db (For Intrinsically Safe option)
EN 60079-11 (For Intrinsically Safe option)
EN60079-0, EN60079-1, EN13463-1,
EN13463-5 and EN61241-1

Ambient Temperature Range:
-20 to +60 °C (-4 to +140 °F)
*Option -40 to +60 °C (-40 to +140 °F)

Ex d IIC T4 Gb, Ex t IIIC T120°C Db

Ex d [ia Ga] IIC T4 Gb (For Intrinsically Safe option)
Ex t [ia IIIC Da] IIIC T120°C Db (For Intrinsically Safe option)
EN 60079-11 (For Intrinsically Safe option)
EN60079-0, EN60079-1, EN13463-1,
EN13463-5 and EN61241-1

Ambient Temperature Range:
-20 to +60 °C (-4 to +140 °F)
*Option -40 to +60 °C (-40 to +140 °F)

Ex de IIB T4 Gb, Ex t IIIC T120°C Db

Ex de [ia Ga] IIB T4 Gb (For Intrinsically Safe option)
Ex t [ia IIIC Da] IIIC T120°C Db (For Intrinsically Safe option)
EN 60079-11 (For Intrinsically Safe option)
EN60079-0, EN60079-1, EN60079-7,
EN13463-1, EN13463-5 and EN61241-1

Ambient Temperature Range:
-20 to +60 °C (-4 to +140 °F)
*Option -40 to +60 °C (-40 to +140 °F)

Ex de IIC T4 Gb, Ex t IIIC T120°C Db

Ex de [ia Ga] IIC T4 Gb (For Intrinsically Safe option)
Ex t [ia IIIC Da] IIIC T120°C Db (For Intrinsically Safe option)
EN 60079-11 (For Intrinsically Safe option)
EN60079-0, EN60079-1 and EN60079-7,
EN13463-1, EN13463-5 and EN61241-1

Ambient Temperature Range:
-20 to +60 °C (-4 to +140 °F)
*Option -40 to +60 °C (-40 to +140 °F)

Canada – Hazardous area

CSA Explosionproof, Class I, Div 1, Groups C & D, T4

Temperature -20 to +60 °C (-4 to +140 °F)
*Option -40 to +60 °C (-40 to +140 °F)

CSA Explosionproof, Class I, Div 1, Groups B, C & D, T4

Temperature -20 to +60 °C (-4 to +140 °F)
*Option -40 to +60 °C (-40 to +140 °F)

CSA Dust Ignitionproof, Class II, Div 1, Groups E, F & G, T4

Temperature -20 to +60 °C (-4 to +140 °F)
*Option -40 to +60 °C (-40 to +140 °F)

International – Hazardous Area IECEx

Ex d IIB T4 Gb, Ex t IIIC T120°C Db

Ex d [ia Ga] IIB T4 Gb (For Intrinsically Safe option)
Ex t [ia IIIC Da] IIIC T120°C Db (For Intrinsically Safe option)
IEC 60079-11 (For Intrinsically Safe option)
IEC60079-0, IEC60079-1 and IEC61241-1

Ambient Temperature Range:
-20 to +60 °C (-4 to +140 °F)
*Option -40 to +60 °C (-40 to +140 °F)

Ex d IIC T4 Gb, Ex t IIIC T120°C Db

Ex d [ia Ga] IIC T4 Gb (For Intrinsically Safe option)
Ex t [ia IIIC Da] IIIC T120°C Db (For Intrinsically Safe option)
IEC 60079-11 (For Intrinsically Safe option)
IEC60079-0, IEC60079-1 and IEC61241-1

Ambient Temperature Range:
-20 to +60 °C (-4 to +140 °F)
*Option -40 to +60 °C (-40 to +140 °F)

Ex de IIB T4 Gb, Ex t IIIC T120°C Db

Ex de [ia Ga] IIB T4 Gb (For Intrinsically Safe option)
Ex t [ia IIIC Da] IIIC T120°C Db (For Intrinsically Safe option)
IEC 60079-11 (For Intrinsically Safe option)
IEC60079-0, IEC60079-1, IEC60079-7 and IEC61241-1

Ambient Temperature Range:
-20 to +60 °C (-4 to +140 °F)
*Option -40 to +60 °C (-40 to +140 °F)

Ex de IIC T4 Gb, Ex t IIIC T120°C Db

Ex de [ia Ga] IIC T4 Gb (For Intrinsically Safe option)
Ex t [ia IIIC Da] IIIC T120°C Db (For Intrinsically Safe option)
IEC 60079-11 (For Intrinsically Safe option)
IEC60079-0, IEC60079-1, IEC60079-7 and IEC61241-1

Ambient Temperature Range:
-20 to +60 °C (-4 to +140 °F)
*Option -40 to +60 °C (-40 to +140 °F)

USA – Hazardous Area

FM. Explosionproof, Class I, Div 1, Groups C & D, T4

FM. Explosionproof, Class I, Div 1, Groups C & D, T4 provides intrinsically safe circuits Class I, Div 1, Groups A - D (for Intrinsically Safe option)

Ambient Temperature Range:
-20 to +60 °C (-4 to +140 °F)
*Option -40 to +60 °C (-40 to +140 °F)

FM. Explosionproof, Class I, Div 1, Groups B, C & D, T4

FM. Explosionproof, Class I, Div 1, Groups B, C & D, T4 provides intrinsically safe circuits Class I, Div 1, Groups A - D, T4 (for Intrinsically Safe option)

Ambient Temperature Range:
-20 to +60 °C (-4 to +140 °F)
*Option -40 to +60 °C (-40 to +140 °F)

FM. Dust Ignitionproof, Class II, Div 1, Groups E, F & G, T4

FM. Dust Ignitionproof, Class II, Div 1, Groups E, F & G, T4 provides intrinsically safe circuits Class I, Div 1, Groups A - D, T4 (for Intrinsically Safe option)

Ambient Temperature Range:
-20 to +60 °C (-4 to +140 °F)
*Option -40 to +60 °C (-40 to +140 °F)

3.0 Hazardous Area Approvals

Maximum Entity Parameters

Terminals 1, 2, 3.			Terminals 6, 7, 8.		
Ui: 30 V	Ci: 0.12 µF	Uo: 0	Ui: 30 V	Ci: 0.12 µF	Uo: 0
Ii: 250 mA	Li: 0	Io: 0	Ii: 250 mA	Li: 0	Io: 0
Pi: 700 mW		Po: 0	Pi: 700 mW		Po: 0

Ui - maximum voltage (peak AC or DC) that can be applied to the terminals of actuator and in accordance with the instructions provided without invalidating the type of protection

Ii - maximum current (peak AC or DC) that can be applied to the terminals of actuator and in accordance with the instructions provided without invalidating the type of protection

Pi - maximum power that can be applied to the terminals of actuator and in accordance with the instructions provided without invalidating the type of protection

Ci - maximum equivalent internal capacitance of the circuit which is considered as appearing across the terminals

Li - maximum equivalent internal inductance of the circuit which is considered as appearing at the connection facilities

Uo - maximum voltage (peak AC or DC) that can appear at the terminals of actuator and in accordance with the instructions provided at any applied voltage up to the maximum voltage

Io - maximum current (peak AC or DC) in apparatus that can be taken from the connection facilities of the actuator

Po - maximum electrical power that can be taken from the terminals of the actuator

Special Conditions For Safe Use (ATEX & IECEx approved actuators)

- The critical dimensions of the flamepaths are:

Flamepath	Maximum Gap (mm)	Minimum Length (mm)
Gearcase Electrical Enclosure/Top Cover	0.15	25.00
Gearcase Electrical Enclosure/Terminal Bung	0.15	25.00
Gearcase Terminal Enclosure/Terminal Cover	0.15	26.00
Gearcase Electrical Enclosure/Manual Override Bush (if fitted)	-0.005	28.00
Manual Override Shaft/Gearcase Electrical Enclosure (or bush if fitted)	0.15	25.00
Output Shaft/Output Shaft Bush	0.15	25.00
Output Shaft Bush/Gearcase Electrical Enclosure	-0.005	25.00

Note: Negative sign denotes an interference fit.

- There is a potential electrostatic charging hazard associated with the operating knob and manual handwheel assembly. These items must be cleaned only with a damp cloth.
- When the optional intrinsically safe interface is fitted, terminal 3 and 6 are intended for the connection of cable screens only. These connection points are not isolated from the assembly enclosure and do not comply with the dielectric strength requirements of IEC 60079-11:2006 clause 6.3.12. This should be taken in to account regarding the applicable code of practice, typically IEC/EN 60079-14 clause 12.2.2.3.

4.0 Health & Safety

⚠ WARNING

Before installing the actuator, make sure that it is suitable for the intended application. If you are unsure of the suitability of this equipment for your installation consult Rotork prior to installation.

⚠ WARNING: ELECTRIC SHOCK HAZARD

Installation and servicing must be performed only by qualified personnel.

⚠ WARNING: ELECTROSTATIC DISCHARGE

This equipment houses static sensitive devices. To protect the internal components never touch the printed circuit boards without using electrostatic (ESD) control procedures.

⚠ WARNING: ENCLOSURE MATERIALS

CVA actuator castings are manufactured from aluminium alloy with stainless steel fasteners. The user must ensure that the operating environment and any materials surrounding the actuator cannot lead to a reduction in the safe use of, or the protection afforded by the actuator.

Where appropriate the user must ensure the actuator is suitably protected against its operating environment.

⚠ WARNING: OPERATING BY HAND

Where actuators are supplied with the optional hand-wheel, note that under no circumstances should any additional lever device such as a wheel key or wrench be applied to the hand-wheel in order to develop more force when closing or opening the valve as this may cause damage to the valve and/or actuator. It may also cause the valve to become stuck in the seated or back seated position.

⚠ WARNING: RESERVE POWER PACK

Where actuators are supplied with the Reserve Power Pack assembly please note that the actuator output shaft may move after removal of the power supply.

Move the knob selector to the 'STOP' position to prevent any unwanted electrical movement. The CVA actuator and in particular the power pack contain no user serviceable components and the top cover assembly must be removed by suitably qualified personnel only.

⚠ WARNING

For actuators fitted with failsafe Reserve Power Pack only. The Reserve Power Pack assembly mounted inside the main gearcase contains ultra capacitor cells. Do not attempt to remove actuator to valve fixings or the top cover assembly whilst the actuator HMI LED indicator is illuminated.

The ultra capacitors may take up to 30 minutes to discharge after removal of the power supply and the LED indicator remains illuminated during this time.

There is no requirement to remove the top cover assembly during normal setup and commissioning.

Ultra capacitors contain toxic/irritant materials. If the top cover assembly has to be removed for any reason ensure that the ultra capacitors are fully discharged and the area is adequately ventilated prior to removal of the top cover assembly, allow any vapours to disperse before gaining entry in to the enclosure.

Use appropriate hand/eye protection and inspect the ultracapacitor cells for signs of liquid or gel leakage before handling.

When working with capacitors ensure adequate ventilation, protect hands and eyes from contact by use of Butyl or Neoprene gloves and safety goggles. Wash hands after handling damaged cells.

Dispose of Reserve Power Pack module in accordance with federal, state and local regulations.

A material data sheet is available from Rotork upon request.

5.0 Storage

5.1 Receiving / Inspection

Carefully inspect for shipping damage. Damage to the shipping carton is usually a good indication that it has received rough handling. Report all damage immediately to the freight carrier and your local CVA distributor.

Unpack the product and information packet taking care to save the shipping carton and any packing material should return be necessary. Verify that the items on the packing list or bill of lading agree with your own documentation.

5.2 Storage

If your actuator cannot be installed immediately store it in a dry place until you are ready to connect incoming cables.

If the actuator has to be installed but cannot be cabled it is recommended that any plastic transit cable entry plugs are replaced with PTFE sealed metal plugs.

The Rotork double-sealed construction will preserve internal electrical components perfectly if left undisturbed. It is not necessary to remove any electrical compartment covers in order to commission the CVQ actuator.

Rotork cannot accept responsibility for deterioration caused on-site once the covers are removed. Every Rotork actuator has been fully tested before leaving the factory to give years of trouble free operation providing it is correctly commissioned, installed and sealed.

5.3 Identification Label

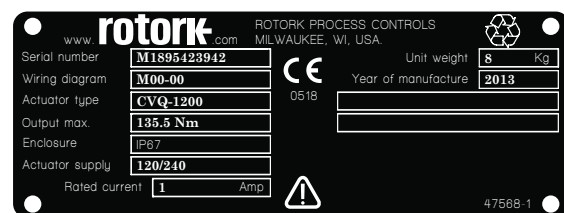

6.0 Operating your Actuator

The following instructions must be followed and integrated into your safety program when installing and using Rotork products.

- Read and save all instructions prior to installing, operating and servicing this product
- If you don't understand any of the instructions contact Rotork for clarification
- Follow all warnings, cautions and instructions marked on and supplied with the product
- Inform and educate personnel in the proper installation, operation and maintenance of the product

Install equipment as specified in Rotork installation instructions and as per applicable local and national codes of practice. Connect all products to the proper electrical sources.

- To ensure proper performance, only use qualified personnel to install, operate, update and maintain the unit
- When replacement parts are required, ensure that the qualified service technician uses only replacement parts specified by Rotork
- Substitutions will invalidate any hazardous area certification and may result in fire, electrical shock, other hazards or improper operation
- Keep all product protective covers in place (except during installation or maintenance by qualified personnel) to prevent electrical shock, personal injury or damage to equipment
- Operation of the actuator in an inappropriate fashion may cause harm or damage to the unit or surrounding equipment

⚠ WARNING: OPERATING BY HAND

Where actuators are supplied with the optional hand drive mechanism that under no circumstances should any additional lever device such as a wheel key or wrench be applied to the hand-wheel in order to develop more force when closing or opening the valve, this may cause damage to the valve and/or actuator. It may also cause the valve to become stuck in the seated or back seated position.

Move the Selector Knob to the STOP position before attempting to operate the actuator manually.

NOTE: MANUAL OVERRIDE DEVICE HAS A SLIPPING CLUTCH SYSTEM.

THE OPERATING KNOB WILL SLIP WHEN MAXIMUM INPUT TORQUE IS EXCEEDED.

Locate the hand Drive mechanism on the underside of the actuator gear-case. The housing rotates on a spring loaded pivot.

Move the mechanism through 90° away from the actuator housing and hold in place. Rotate the handwheel to move the actuator output drive to the desired position.

Release the mechanism to return to Motor Drive.

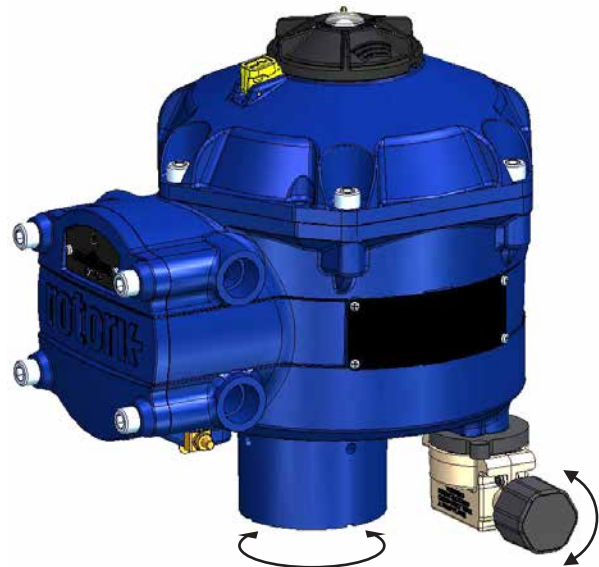

⚠ WARNING: OPERATING ELECTRICALLY

Check that the power supply voltage agrees with that on the actuator nameplate.

Do not switch on the power supply until you have checked that the actuator has been connected correctly.

6.0 Operating your Actuator

6.1 Local Controls

The actuator is supplied with a 3 position selector knob located on the top cover assembly. The knob assembly has a locking latch to enable the control knob to be padlocked in position. In the centre of the knob assembly is a tri-state LED. Refer to Table 1 for full details of LED indication.

The LED has 3 colour states RED, GREEN or BLUE.

The LED can be 'ON' or FLASHING depending on the actuator status.

Stop

With the selector knob in the 'STOP' position no electrical operation is possible.

Run

With the selector knob in the 'RUN' position the actuator will respond to remote control commands. During commissioning or diagnostic procedures using PDA or Smartphone *Bluetooth*[®] wireless enabled devices the actuator may not be operated remotely.

Note when STOP or RUN is selected the control knob will rotate between the two positions without having to depress the locking latch. It is also possible to lock the selector in the 'RUN' or 'STOP' only position.

Test

With the selector knob in the 'TEST' position an Auto Test routine will be initiated if the function is enabled.

This is a quick method of testing the actuators ability to control its output independent of the external control system. The actuator will perform a series of step and cycle routines centred around the last demand position. No greater than +/- 4% of last set point.

The test will measure the following parameters:

- Deadtime
- Step response time
- Setting time
- Average thrust/torque in each direction of travel
- Full stroke speed
- Valve friction

The user LED on the selector knob will fast flash for 10 seconds.

Flashing Green - All parameters in acceptable limits

Flashing Red - One or more parameters outside of acceptable limits



Fig 6.1



Fig 6.2



Fig 6.3



Fig 6.4

6.0 Operating your Actuator











LED Indication	Actuator Status	Mode of Operation
	Solid Green - No faults	Run or Test Note - Electrical operation is not possible whilst the RPP is charging
	Green - Slow Flash - Auto Test in progress or Reserve Power Pack (RPP) charging (if fitted)	
	Green - Fast Flash Auto Test completed successfully	
	Blue - Fast Flash Initiating <i>Bluetooth</i> [®] connection	Run
	Blue - Slow Flash <i>Bluetooth</i> [®] communication active	
	Green/Blue - Alternate Flash <i>Bluetooth</i> [®] communication active No faults	Run or Test
	Red/Blue - Alternate Fast Flash Initiating <i>Bluetooth</i> [®] connection	Stop
	Red/Blue - Alternate Slow Flash <i>Bluetooth</i> [®] communication active Fault found or Stop selected.	
	Solid Red Major fault found	Run/Test/Stop
	Flashing Red Stop selected or minor fault found	Stop
	Red/Green Alternate Flash Power failure and UPS active	Run/Test/Stop

Table 1

Note: Slow Flash = 0.5Hz
Fast Flash = 1.0Hz

6.0 Operating your Actuator

6.2 Reserve Power Pack (optional)

The actuator can be fitted with an optional 'Reserve Power Pack' consisting of Super Capacitors to allow the actuator to go to a pre-determined position on power failure.

On power up the super capacitors require a charging period during which time the actuator electrical operation will be inhibited. This could take up to two minutes.

NOTE: Electrical operation is inhibited and the LED will flash during the charging period.

On loss of power supply the actuator will carry out its designated failsafe function. The LED remains illuminated until the energy stored in the capacitors has depleted.

WARNING

Where actuators are supplied with the Reserve Power Pack assembly please note that the actuator output shaft may move after removal of the power supply.

Move the Knob Selector to the 'STOP' position to prevent any unwanted electrical movement before carrying out any maintenance or removal of the unit from the valve.

After disconnection of the actuator power supply wait until the LED indicator on the top cover assembly has extinguished before attempting to remove the actuator from the valve. Under no circumstances attempt to remove the actuator or adjust the output drive shaft connection to the valve stem whilst the top cover LED is illuminated.

The CVA main housing of the actuator and in particular the power pack contain no user serviceable components and the top cover assembly must be removed by suitably qualified personnel only.

DO NOT REMOVE ANY COVER ASSEMBLY TO GAIN ACCESS TO THE ELECTRICAL COMPARTMENTS WHILST THE LED LOCATED ON THE SELECTOR KNOB IS ILLUMINATED.



7.0 Installation & Setup Guide

7.1 Commissioning

The Rotork CVA Range of actuators provide simple, safe and rapid non-intrusive commissioning using a *Bluetooth*[®] wireless enabled PDA. Actuator limit setting can be achieved using the Automatic Setup feature.

Tools & Equipment Required

Bluetooth enabled hand-held computer (PDA) or Smartphone (screen resolution 240 x 320 minimum) running Windows Mobile operating system.

Note: Local operation is only possible with a PDA or Smartphone. Alternatively if the HART option card is fitted a HART communicator can be used.

Software

The Rotork Enlight CVA software must be installed on the PDA or Smartphone before carrying out any commissioning procedures.

The software is free and is available for download from the Rotork website at www.rotork.com

CAUTION

It is essential that the setup procedure is carried out when the valve is not under working process conditions, as full valve movement will occur.

If actuators are fitted with a failsafe capacitor pack the unit may operate the valve on removal of the power supply.

To prevent this occurrence, it will be necessary to reconfigure the failsafe action, see page 41. Alternatively 'STOP' can be selected to prevent unwanted movement.

IMPORTANT

It is essential that the actuator is mounted correctly to the valve!

Refer to Rotork PUB042-001 for further details.

The Installation & Setup will include the following procedures:

1. Prepare the drive bush
2. Ensure valve position is noted and safe (offline)
3. Mount and align actuator to valve
4. Adjust mechanical stops
5. Use of PDA to set limits of travel
6. Use of PDA to configure control and indication parameters



7.0 Installation & Setup Guide

7.2 Quick Setup Flow Chart

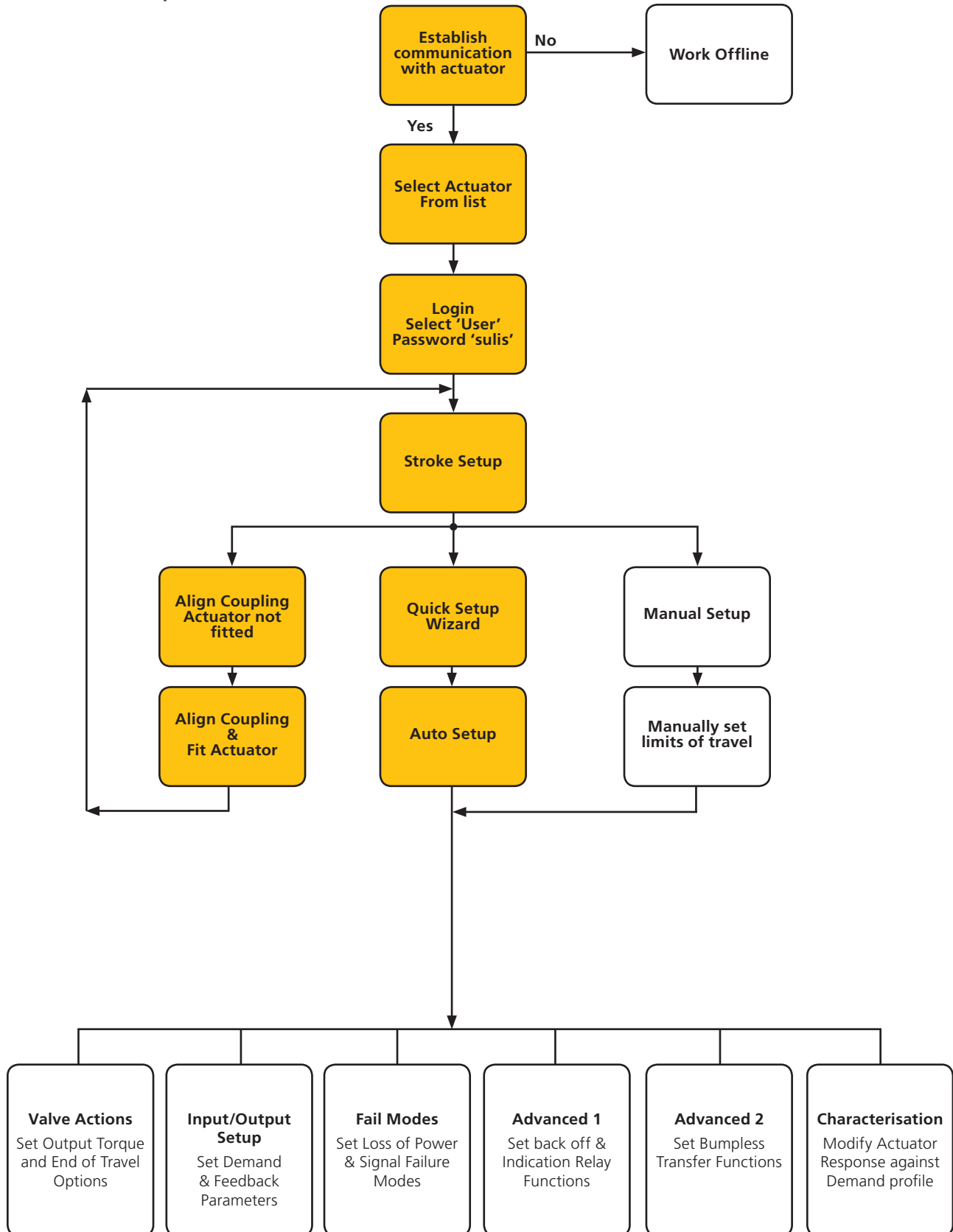

7.0 Installation & Setup Guide

7.3 Mounting the Actuator

Prepare Drive Bush

Remove four caphead screws securing the blank drive bush. Machine drive bush to suit valve stem. Ensure machined position allows correct orientation of actuator to valve flange and direction to close the valve.

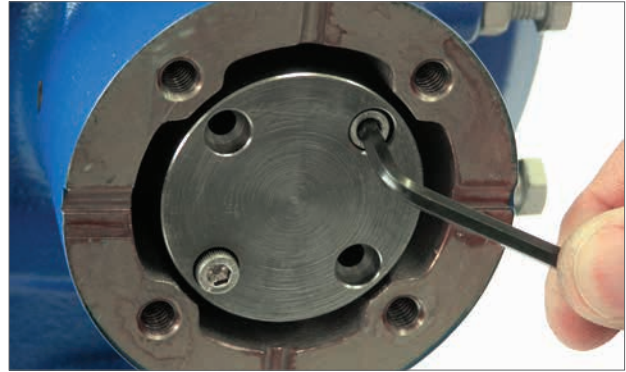

Fig 7.1

Fitting the Drive Bush

Note: The drive bush can be fitted in four possible positions 90° apart.



Fig 7.2

Check the Drive bush for fit and orientation against the valve stem before assembly.

Whilst the Drive Bush is removed it is possible to note the position of the actuator output shaft.

Fig 7.4 shows the actuator output shaft position indent (circled) in the 'Clockwise Closed' position.

Fit the drive bush in to centre column assembly ensuring that the stem orientation, actuator position and direction of operation are correct for valve operation. Secure the drive bush with cap screws supplied.



Fig 7.3

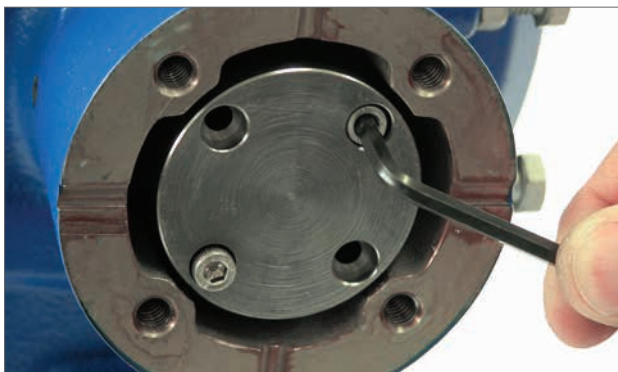

Fig 7.5



Fig 7.4

7.0 Installation & Setup Guide

Securing Actuator to Valve

Before fitting actuator to the valve ensure that the actuator and valve are in the same position. The position of the actuator can be confirmed by either using the handwheel when fitted or by application of the electrical power supply and use of a PDA.

A suitable mounting flange conforming to ISO 5211 or USA standard MSS SP-101 depending on the actuator supplied must be provided to mount the unit to the valve top works assembly.

Actuator to mounting flange assembly fixings must conform to Material Specification ISO Class 8.8. Delta GZ coated Grade A4 stainless steel fixings are recommended.

Position actuator on to the valve mounting flange.

It may be necessary to adjust the position of the actuator to enable alignment of the fixing bolts.

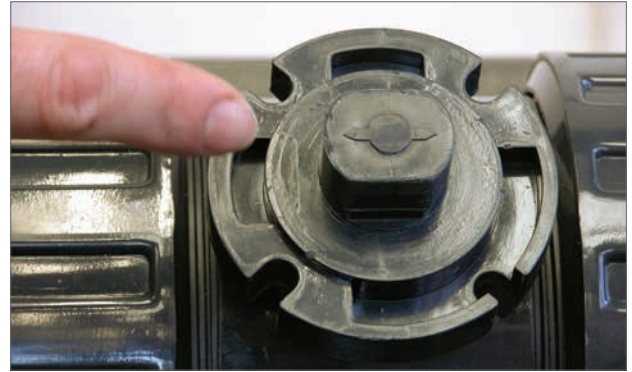

Fig 7.6



Fig 7.7

Tighten base fixings in accordance with Table 2.

NOTE: Should electrical operation be required to set the stop bolts it will be necessary to connect electrical power cables, establish Bluetooth® wireless communication using a PDA or Smartphone then carry out the Align Coupling Procedure.

Go to page 23 for STOP BOLT adjustment procedure.

Thread Size	Torque Nm	Torque lb/ft
5/16 UNC	12.8	9.4
M8	12.6	9.3

Table 2

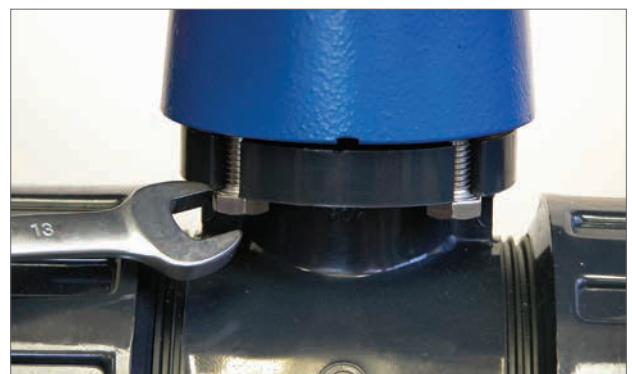

Fig 7.8

7.0 Installation & Setup Guide

7.4 Cable Connections

Move the Mode selector knob on top of the required actuator to the 'STOP' position. This will inhibit electrical operation.

WARNING

Ensure all power supplies are isolated before removing actuator covers.

Check that the supply voltage agrees with that stamped on the actuator nameplate. A fuse or circuit breaker must be included in the wiring installation of the actuator. The switch or circuit breaker must be installed as close as possible to the actuator and shall be marked to indicate that it is the disconnecting device for that particular actuator. The actuator must be protected with an over current protection device rated in accordance with publication PUB042-010, which details the electric motor performance data for CVA range actuators.

7.4.1 Earth Ground Connections

A lug with a 6 mm diameter hole is cast adjacent to the conduit entries for attachment of an external protective earthing strap by nut and bolt. An internal earth terminal is also provided. However it must not be used alone as the protective earth connection.

7.4.2 Removing Terminal Cover

Using an 8 mm Allen key loosen the captive fixings securing the terminal compartment cover. Do not attempt to lever off the cover with a screwdriver as this will damage the o-ring seal and may damage the flamepath on a certified unit. Remove the power terminal insulated cover and connect temporary or site wiring in accordance with the supplied wiring diagram.

Note: The Red (Power) and (Control) terminal protective covers should be replaced prior to refitting of the electrical cover assembly.

When the actuator is supplied with an Intrinsically safe terminal compartment, the unit is supplied with a Red (Power & Non IS control connections) and Blue terminal cover. The Blue terminal cover identifies the IS Circuit connections.



Fig 7.9



Fig 7.10



Fig 7.11 Standard Terminal Block



Fig 7.13

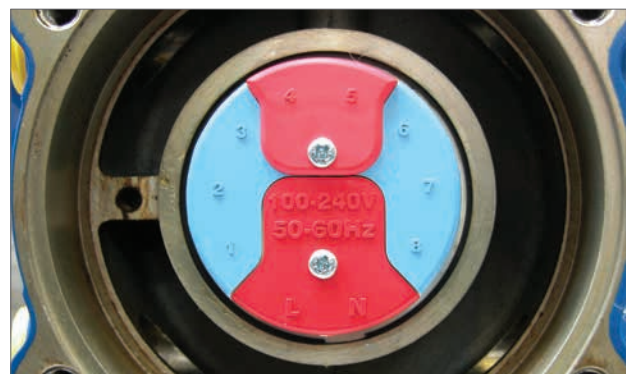

Fig 7.12 IS Terminal Block

7.0 Installation & Setup Guide

7.4.3 Cable Entry

The cable entries are tapped either $\frac{3}{4}$ " NPT or M25. Remove any plastic transit plugs. Make off cable entries appropriate to the cable type and size. Ensure that threaded adaptors, cable glands or conduit are tight and fully waterproof. Seal unused cable entries with steel or brass threaded plugs.

If the actuator is to be installed in a hazardous area, a suitably certified cable gland must be fitted with the use of a certified thread adaptor where appropriate.

Unused entries must be closed with a suitably certified stopping plug.

Wiring installation must comply with local statutory regulations.

7.4.4 Connecting to Terminals

On EExde enclosure units connections to the power and control terminals must be made using AMP type 160292 ring tabs for power and earth terminals and AMP type 34148 ring tabs for the control terminals.

Refer to the wiring diagram to identify functions of terminals. Check that the supply voltage is the same as that marked on the actuator nameplate.

Remove power and control terminal screens. Begin by connecting the power cables followed by the control cables (as required).

Refit power and control terminal screens. When all connections are made refit protective terminal covers.

Note: The Power and the Control terminal protective covers should be refitted prior to refitting of the electrical cover assembly.

When the actuator is supplied with an Intrinsically Safe terminal compartment the Red and Blue terminal covers MUST be fitted to maintain certification.

7.4.5 Replacing Terminal Cover

Ensure cover o-ring seal and spigot are in good condition and lightly greased before refitting cover.



Fig 7.18

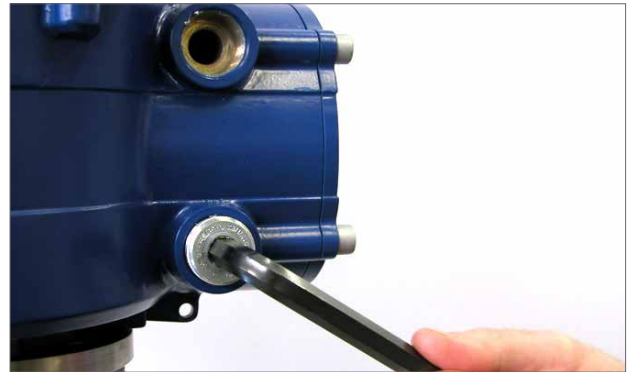

Fig 7.14

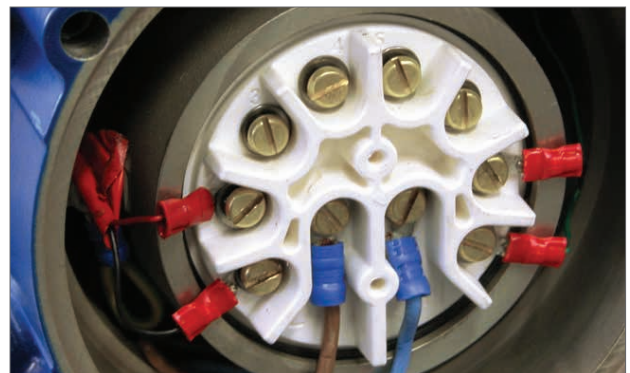

Fig 7.15

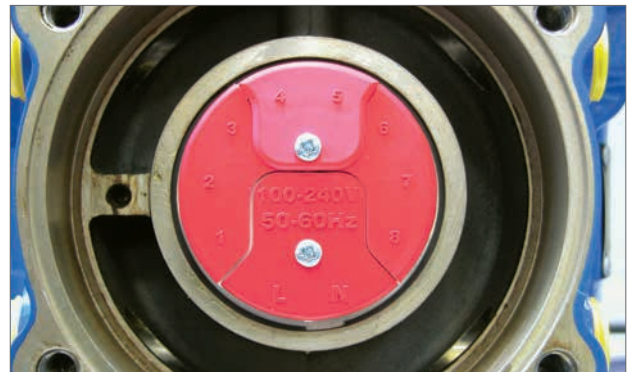

Fig 7.16 Standard Terminal Block



Fig 7.17 IS Terminal Block

7.0 Installation & Setup Guide

7.5 Commissioning

Move the actuator selector knob to the 'STOP' position.

7.5.1 Apply Electrical Power

On completion of the correct assembly and electrical connection procedures, the electrical power supply can now be applied to the actuator.

NOTE: If the unit is fitted with failsafe capacitors the Green or Red LED (depending on Mode selected) on the selector will flash until the capacitors are fully charged.

Movement is not possible whilst the LED is flashing.



Fig 7.19

7.5.2 Establish Bluetooth® Wireless Communications

It is now required to establish communications in order to complete the fitting procedure.

Ensure *Bluetooth* is enabled on the PDA then click on the Enlight Icon to start the program.

The maximum range of Bluetooth wireless communication is 10 metres.

The first screen gives the option to connect to an actuator or open a saved file.

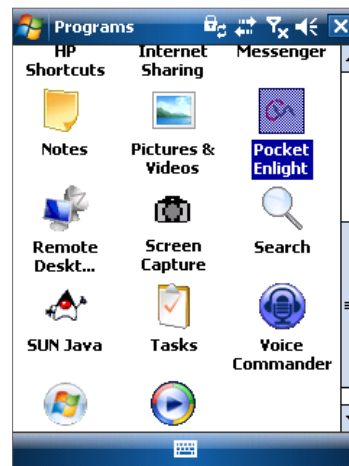

Fig 7.20

WORK OFFLINE

If there is a configuration file stored in the PDA it can be opened to review files.

RECONNECT AN ACTUATOR

If a link between the PDA and actuator has previously been established a list will appear and a search for new devices will not occur.

DISCOVER A NEW ACTUATOR

The PDA will search a radius of 10 meters for CVA actuators.

QUIT

Exit the menu.

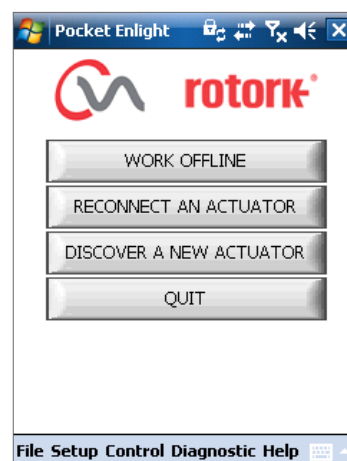

Fig 7.21

7.0 Installation & Setup Guide

7.6 Reconnect or Discover an Actuator

7.6.1 Searching for Actuator

The PDA will now search for any CVA actuators within *Bluetooth*[®] wireless range.

If there is more than one device a list will be generated.

Highlight, then select the required actuator from the list of units within range.

The actuator will generally report its identity by its serial number (shown on nameplate).

This can be modified to add an MOV or Tag reference. (See full PDA menu details).

If there are numerous *Bluetooth* devices in range the search process will take longer to complete and in some cases may have to be repeated.

7.6.2 Login Procedure

Before the link can be established it is necessary to log in.

There are three levels of login with password protection to limit higher level access.

7.6.3 View

Allows review of actuator settings only. No changes can be made.

Password : **view**

7.6.4 User

Allows access to review and change actuator settings. Includes the facility to set limits of travel and take local control of the actuator.

Default Password : **sulis**

This password can be changed using the 'Setup' menu to provide additional site security.

DO NOT LOSE THE PASSWORD INFORMATION

Rotork Engineer

Rotork use only.

7.7 Login

Select '**User**' on the User Level drop down menu. Note, user is the default and will appear in the box.

Using the keyboard at the bottom of the screen, type in the password then click on 'OK' to start the procedure. If communication is successful you will be prompted to wait whilst the setup data is retrieved from the actuator.

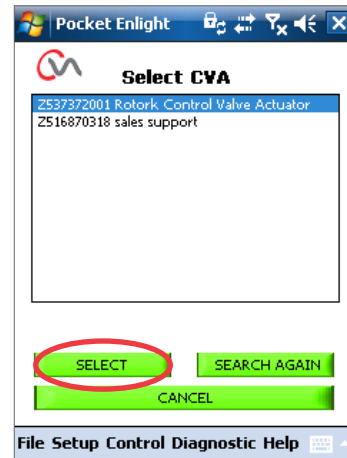

Fig 7.24

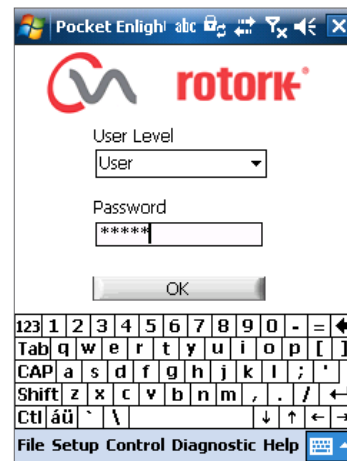

Fig 7.22



Fig 7.23

7.0 Installation & Setup Guide

If the incorrect password is entered an error message will be displayed. The actuator password cannot be reset. An error code will be generated, make a note of the code then please contact your local Rotork representative stating the full error code.

The actuator's current password may then be verified and confirmed.

7.8 Stroke Setup Menu

There are three choices from this menu.

Align Coupling

If the actuator is not fully fitted to the valve this procedure must be carried out to enable alignment of the actuator coupling and adjustment of stop bolts.

Quick Setup Wizard

Use this menu to automatically set actuator limits of travel.

Go to page 25.

Manual Setup

Use this menu to manually set actuator limits of travel.

Go to page 31.

It is possible on this screen to choose Imperial or Metric units. The actuator serial number, current valve stroke and position are also displayed.

⚠ WARNING

The default setting of a new actuator is **minimum torque and clockwise to close**. If the actuator has previously been commissioned it is essential that its basic settings be checked before fitting the coupling and operating the actuator electrically. Check the settings in the Manual Setup menu, adjust if necessary.

⚠ WARNING

When RUN mode is selected the actuator will respond to any active remote control commands.

Select 'STOP' on the actuator Selector Knob to prevent any unwanted movement.

7.9 Fitting Actuator to Valve

Select the '**ALIGN COUPLING**' option.
Select Metric or Imperial units as required.

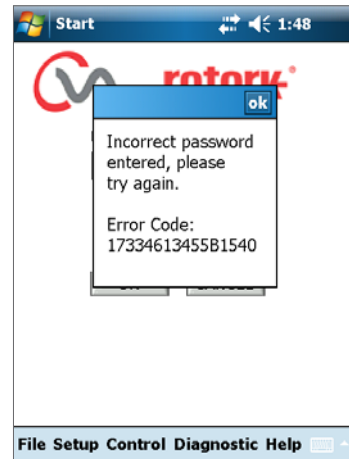

Fig 7.25

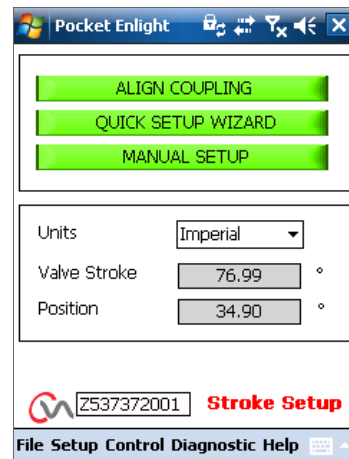

Fig 7.26

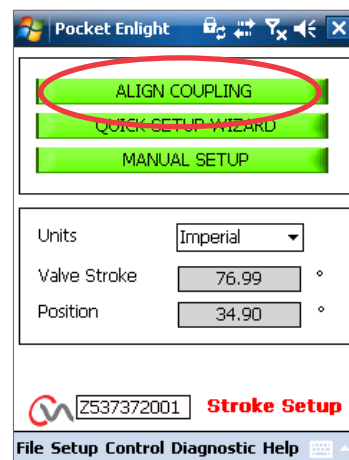

Fig 7.27

7.0 Installation & Setup Guide

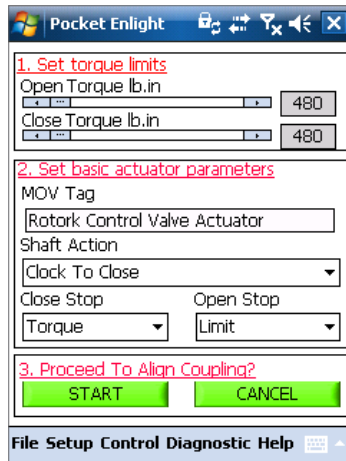

Fig 7.28

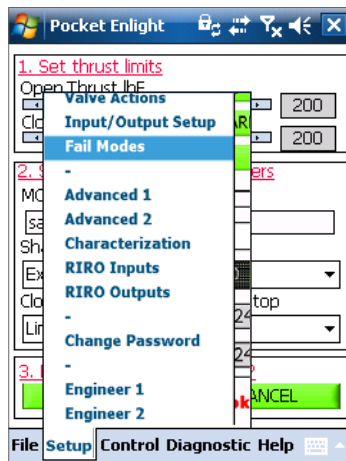

Fig 7.29

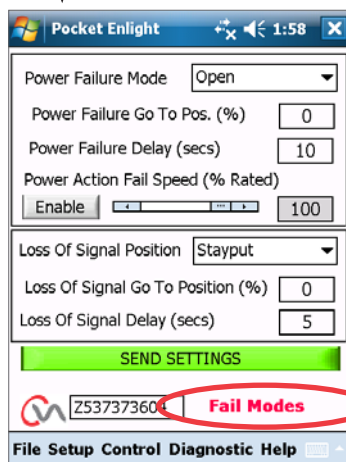

Fig 7.30

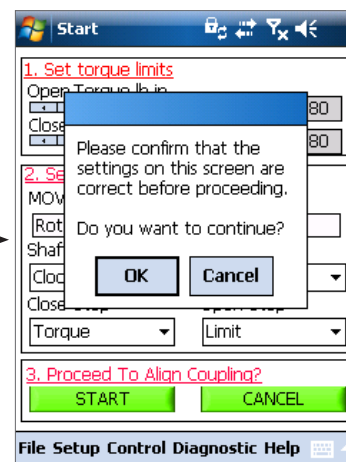

Fig 7.31

1. Set Torque Limits

The maximum amount of torque available for the open and close direction of travel can be adjusted by dragging the slider from left to right.

2. Set Basic Actuator Parameters

MOV Tag

The actuator can be given a Tag number for ease of identification in the field.

Shaft Action

Set Clock or Anticlock direction to close the output drive shaft.

Close/Open Stop

Torque - Apply set torque to the valve stem at end of travel limit where valve tight shutoff is required.

Limit - Stop the actuator at the set limit where valve does not require tight shutoff.

Select the START option to save changes.

Select basic parameters and torque limit settings as required.

3. Proceed to Align Coupling

To commence manual alignment of coupling and adjustment of Stop Bolts, click on the start box.

⚠ WARNING

When RUN mode is selected the actuator will respond to any active remote control commands.

If no Analogue request is applied the actuator will carry out its loss of control signal fail to position function. If necessary go to the Fail Modes Menu and select the STAYPUT option and send the settings back to the actuator.

7.0 Installation & Setup Guide

7.10 Align Coupling - Adjust Stop Bolts

It is now possible to operate the actuator using the Enlight program.

Moving the position control slider will rotate the output shaft to enable alignment of the drive bush to the valve stem and adjustment of the STOP bolts. Coarse control will allow full travel of the actuator. Fine control is used for small adjustments of the actuator Output shaft.

Incrementing the position slider using the arrows will vary position by 1% for coarse and 0.1% for fine control.

When the position control is operated for the first time a warning will appear to indicate that the actuator will be taken offline and will not respond to remote control commands.

CAUTION

The actuator will move to the indicated position on the Position Control slider.

Select OK

Click on the 'OK' button, the actuator will be taken offline and will now move to the position as indicated on the position control slider.

The actuator is now unavailable for remote control.

Adjust Actuator Stop Bolts

Refer to the stop bolt adjustment procedure. Use the Fine and Coarse position slider to position the actuator during the stop bolt adjustment procedure.

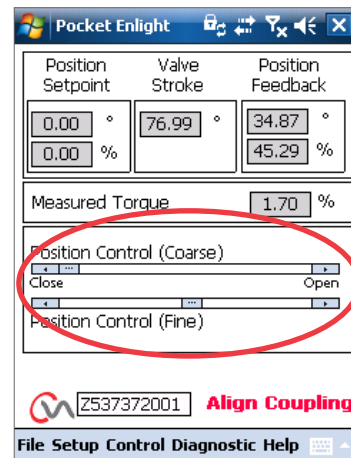

Fig 7.32



7.0 Installation & Setup Guide

Stop Bolt Adjustment

It is recommended that stop bolt adjustment be carried out by the valvemaker/supplier before the valve is fitted on to the pipework.

Once installed the valvemaker/supplier should be consulted before stop bolt re-adjustment is carried out. After setting or adjustment of stop bolts the actuator limits must be reset.

The CVQ stop bolts are located below the main body assembly. The stop bolt adjustment allows +/- 5% variation of travel at each end position. Screwing bolts in reduces the range of movement, out increases range of movement.

For clockwise closing valves the right hand bolt is the closed stop as shown in Fig 7.33. The left hand bolt is the open stop.

Stop bolts are factory set to give a nominal travel of 90°.

Adjustment for Non-Seating Valve Types

For Closed and Open stop position adjustment.

Undo stop bolt locknut. Move actuator and valve to the required stopping position (it may be necessary to unscrew stop bolt to allow more travel). Screw stop bolt in until a stop is felt. Tighten stop bolt lock nut.

Adjustment for Seating Valve Types

Undo stop bolt locknut. Move actuator and valve to the required stopping position (it may be necessary to unscrew stop bolt to allow more travel).

Screw stop bolt in until a stop is felt and then back off by 1 to 3 turns.

Tighten stop bolt lock nut.

Set Actuator Limits of Travel

It is possible to set the limits manually if full valve stroke is not required or automatically using the Quick Setup wizard if full travel is required between the stop bolt positions.

Go to page 25 for Quick Setup or page 31 for Manual setup options.



Fig 7.33



Fig 7.34



Fig 7.35



Fig 7.36

7.0 Installation & Setup Guide

Open and Close Indication Labels

CVQ actuators supplied from July 2013 onwards include two position indicator cutouts on opposing sides of the actuator lower gearcase and a label kit for local Open and Close indication.

It is recommended that the labels are applied to the drive bush after assembly to the valve and setting of the actuator stop bolts.

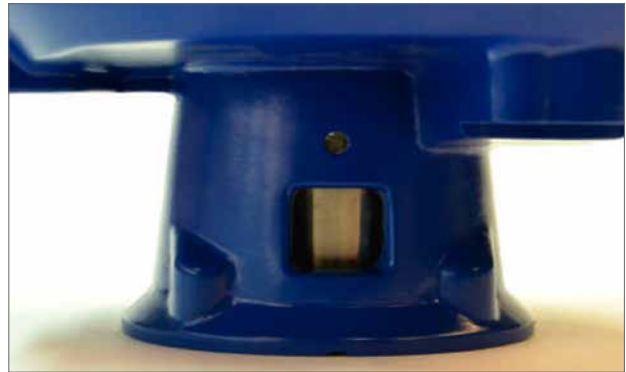

Fig 7.37

⚠ WARNING

Put the selector knob to the 'stop' position to prevent electrical operation of the output shaft and drive bush during this procedure.



Fig 7.38

Move the actuator to the fully CLOSED position.

Ensure that the drive bush is clean and dry.

Select the appropriate Green or Red label, remove from the protective strip and apply through the cutout in the gearcase on each side.



Fig 7.40

Move the actuator to the fully OPEN position.

Ensure that the drive bush is clean and dry.

Select the appropriate Green or Red label, remove from the protective strip and apply through the cutout in the gearcase on each side.



Fig 7.39

7.0 Installation & Setup Guide

7.11 Quick Setup Wizard

If the valve is to be commissioned over its full stroke the quick setup wizard is a fast and efficient way to set the end of travel limits.

The quick set up wizard will allow the actuator to find the end of travel by measuring the output torque.

If the valve is not required to operate over full stroke it is possible to set a fixed OPEN limit.

Select Quick Setup Wizard.

Set Torque Limits

The default torque values for the Auto setup are automatically set to 40% of rated torque in both directions. Adjust if more torque is required to move the valve through stroke.

Set Basic Actuator Parameters

The MOV tag can be edited. Use the keyboard to edit the MOV tag field.

Shaft Action

Select direction to close the output shaft to suit valve operation.

Close/Open Stop

Set the end of travel stop function for Torque or Limit to suit the characteristics of the valve.

Torque

The actuator can be set to apply its selected output 'Torque' to the valve at the end of travel where tight shut off is required.

Limit

Alternatively it can be set to the 'Limit' function to disengage motor drive and stop the valve at a predetermined position where the valve does not require the seating force to be applied to the valve seat or end of mechanical valve travel.

Click on the 'START' box to save changes to the actuator and initiate the Auto Setup routine.

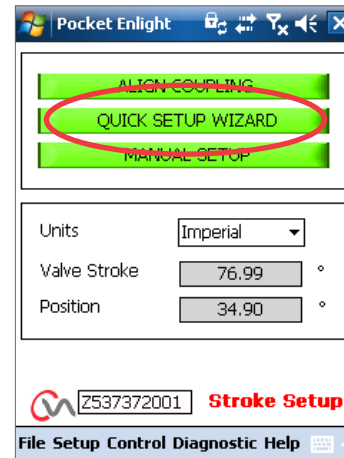

Fig 7.41

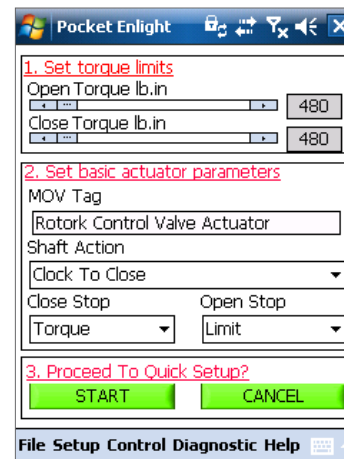

Fig 7.42

7.0 Installation & Setup Guide

Move the selector Knob to the 'RUN' position.



⚠ CAUTION

Initiating an Auto Limit will move the valve through its full stroke.

⚠ WARNING

Ensure torque, shaft action and end stops are correctly set or damage to the valve may occur.

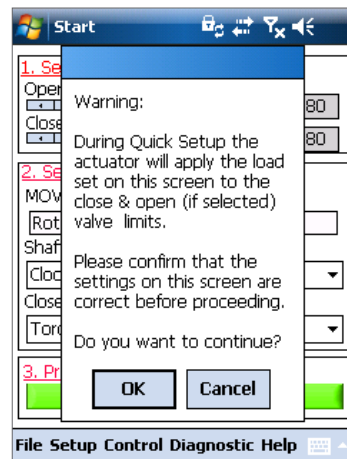

Fig 7.43

AUTO LIMIT will initiate the auto setting procedure.

FIXED LIMIT will allow the actuator to find the closed limit by measuring the torque but will allow the open limit to be set at a measured distance. The distance can be edited in the text box.

NOTE: Ensure that limit is selected for the open stop if fixed limit is applied.

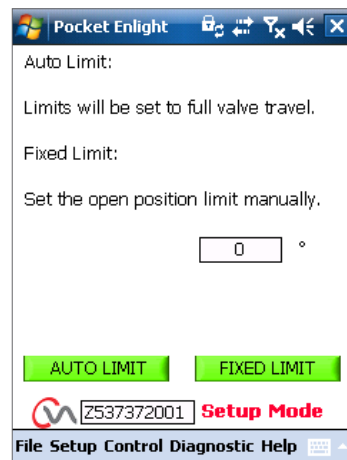

Fig 7.44

7.0 Installation & Setup Guide

The Quick Setup is fully automatic and requires no user input.

Start Quick Setup?

Click on the 'START' box to initiate the Quick Setup procedure. Click on the OK box to continue. All other menus will be disabled until the process is completed.

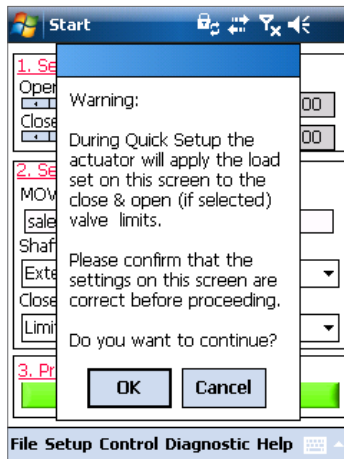

Fig 7.45

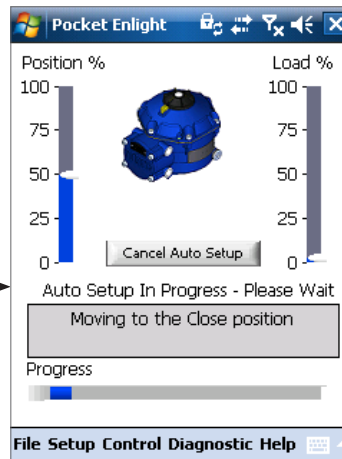

Fig 7.46

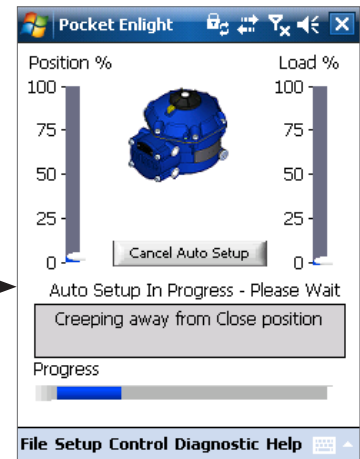

Fig 7.47

Finding the Closed Limit

The actuator will turn its output shaft to the maximum CLOSED limit of travel.

Actuator will then turn its output shaft away from the Closed limit of travel and repeat the procedure to eliminate any inertia effects and re-adjust the end of travel limit as necessary.

7.0 Installation & Setup Guide

Finding the Open Limit

The actuator will turn its output shaft to the maximum Open limit of travel. Actuator will then turn its output shaft away from the Open limit of travel and repeat the procedure to eliminate any inertia effects and re-adjust the end of travel limit as necessary.

The Open position limit is now set and Auto Setup is complete.

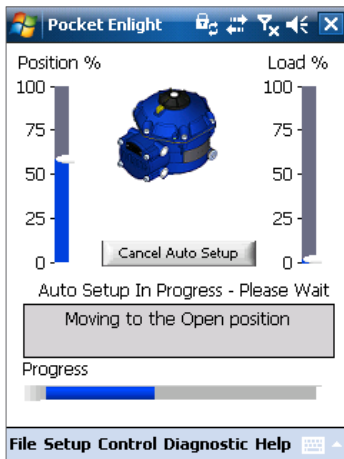

Fig 7.48

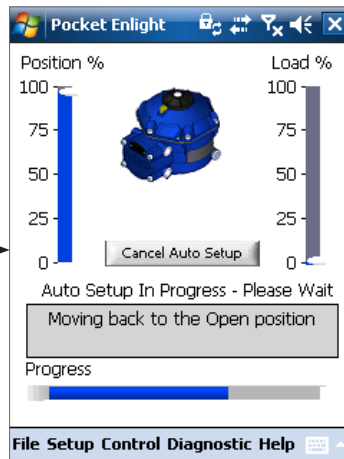

Fig 7.49

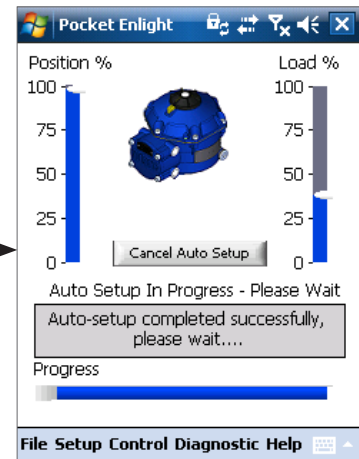

Fig 7.50



7.0 Installation & Setup Guide

Reference Stroke

On completion of the Quick setup action a prompt to record a new torque reference stroke screen appears.

Select 'CANCEL' to finish Quick setup without recording a new torque profile.

Select 'OK' to record a new Torque Profile.

This function will clear the datalogger torque profile logs. The actuator will carry out an Open and a Closed operation. A new torque profile will be generated for the Open and Close directions and can be accessed on future downloads.

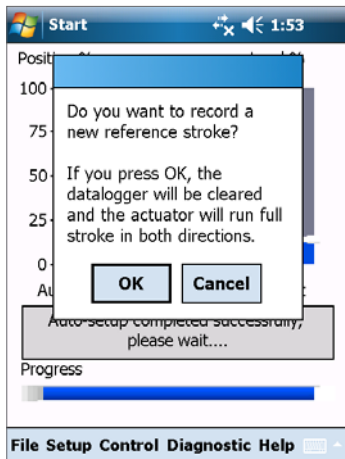

Fig 7.51

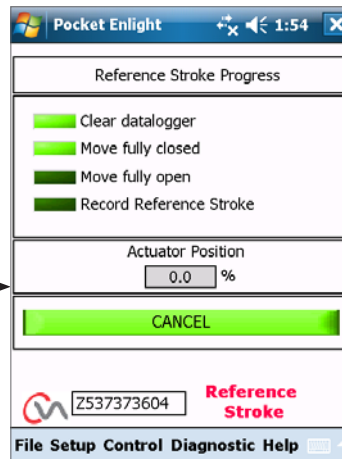

Fig 7.52

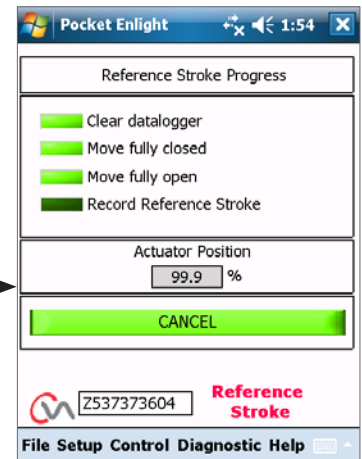

Fig 7.53

Actuator Automatic Setup is now complete.

Auto setup is now complete and both ends of travel tight shut off limits have been defined and set.

PDA screen will return to the Stroke Set up menu.

If no further settings are required move the Mode selector to the 'STOP' or 'RUN' positions depending on desired Operation.

Exit the menu.

For further settings continue on page 35.

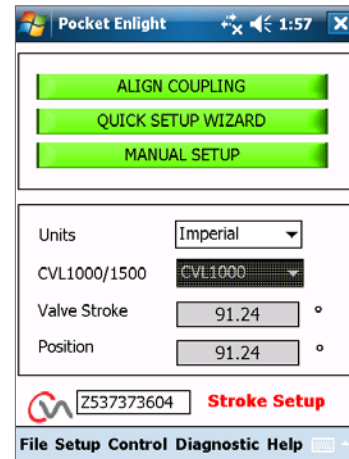
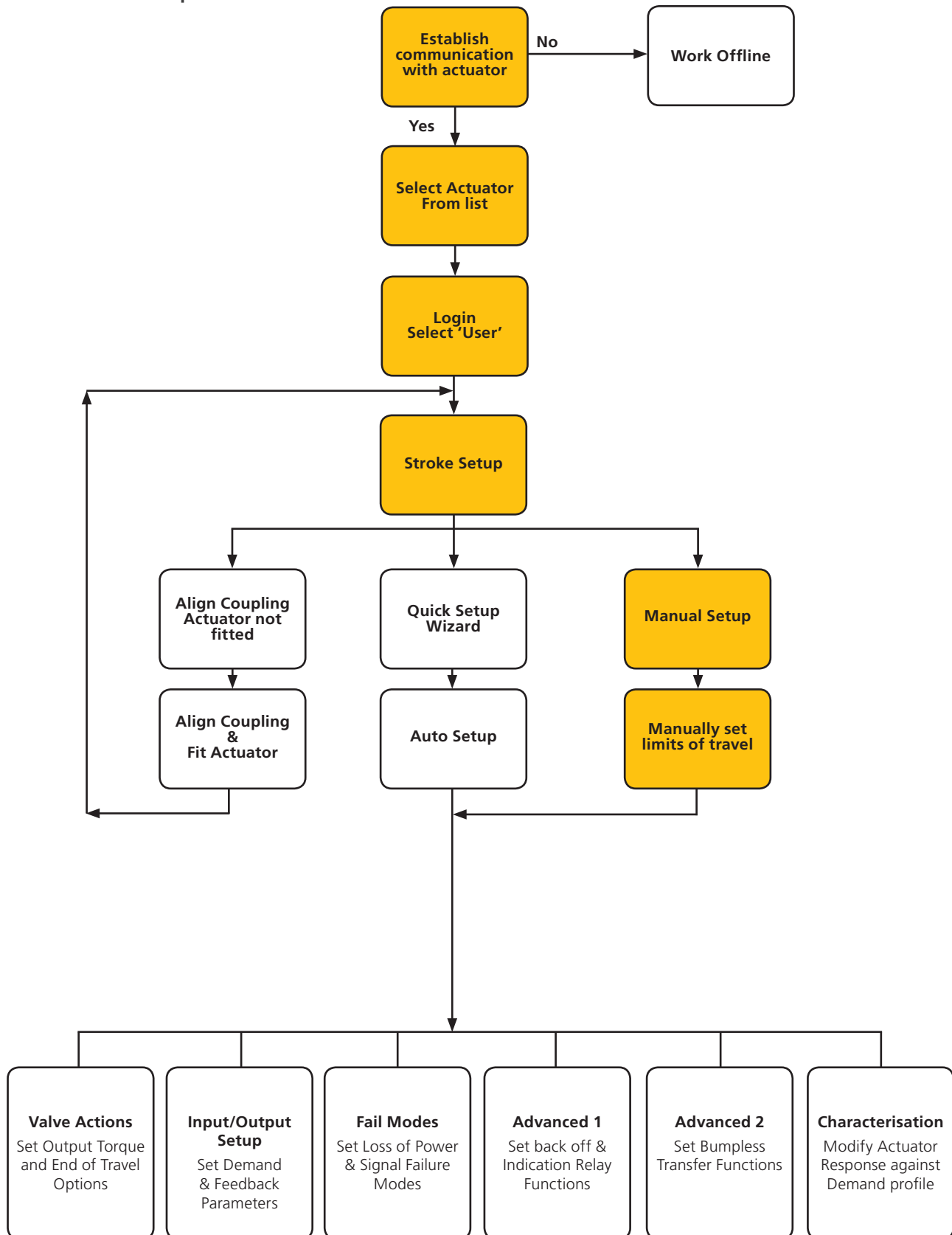

Fig 7.54

7.0 Installation & Setup Guide

7.12 Manual Setup Flow Chart



7.0 Installation & Setup Guide

7.13 Manual Setup

⚠ CAUTION

To prevent unwanted electrical operation move the selector knob to the 'STOP' position.

If manual setting is required or if the limits are to be set for a reduced stroke operation the Manual Setup can be utilised.

From the Stroke Setup page select the Manual Setup option.

⚠ WARNING

Before carrying out this procedure verify that the torque limits and basic actuator parameters are correctly set to prevent damage to the valve.

Set Torque Limits

The default torque values for the Manual Setup are automatically set to a low value for the commissioning procedure.

Open value 40% torque.

Close value 40% torque.

Increase the torque if necessary.

Set Basic Actuator Parameters

The MOV tag can be edited by using the keyboard at the bottom of the screen.

Shaft Action

Select direction to close to suit valve operation.

Close/Open Stop

Set the end of travel stop function for Torque or Limit to suit the characteristics of the valve.

Torque

The actuator can be set to apply its selected output 'Torque' to the valve at the end of travel where tight shut off is required.

Limit

Alternatively it can be set to the 'Limit' function to disengage motor drive and stop the valve at a predetermined position where the valve does not require the seating force to be applied to the valve seat or end of mechanical valve travel.

Proceed to Manual Setup

Click on the 'START' box to confirm changes and commence the Manual Setup procedure.

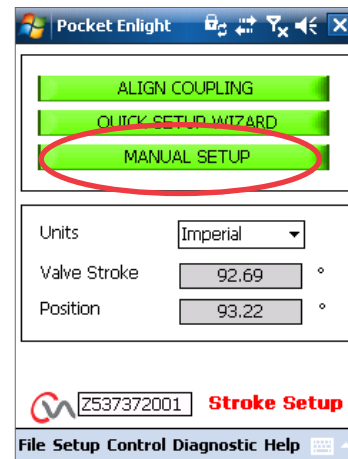

Fig 7.55

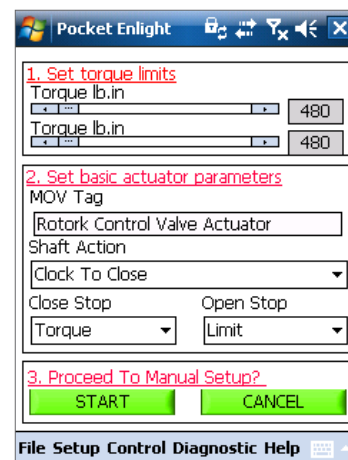

Fig 7.56

7.0 Installation & Setup Guide

To enable electrical operation move the Selector Knob to the RUN position.

⚠ CAUTION

Note: The actuator may respond to any present remote control requests during loss of *Bluetooth* commands or when navigating between screens.

It is now possible to turn the output shaft to the desired position using the position control slider.

⚠ CAUTION

The actuator will be taken offline and will respond to the position control slider.

Confirm that settings are correct before attempting to move the actuator.

Click on OK to proceed.

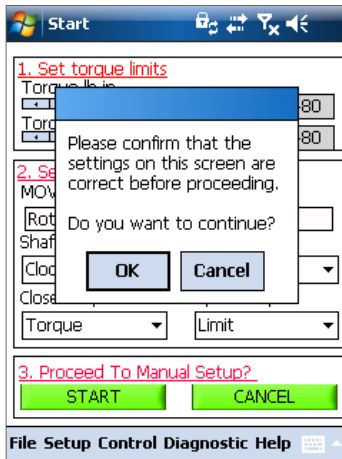

Fig 7.57

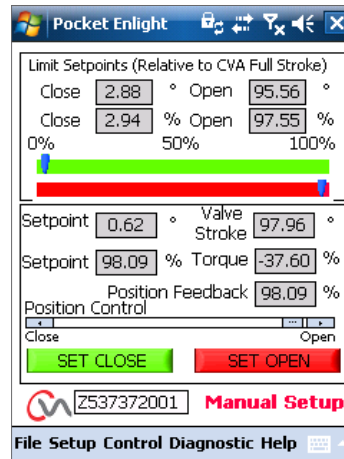

Fig 7.58

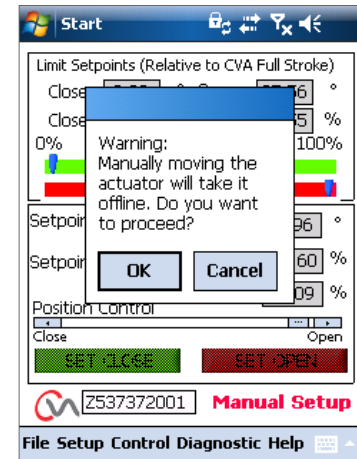

Fig 7.59

7.0 Installation & Setup Guide

When the output shaft is in the desired position, the travel limit can be set using the SET OPEN/SET CLOSE box.

Set Close Limit

Use the Position Control Slider to move the actuator output shaft to the required Closed position.

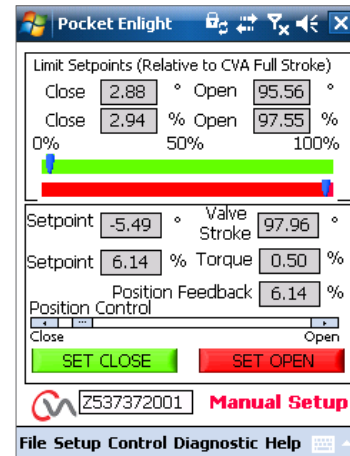

Fig 7.60

Click on the 'Set Close' box to calibrate the closed limit of travel. The 'Set Close' and the 'Serial' number boxes are 'greyed' out during the calibration procedure and indicate acceptance of the new settings when cleared.

The new close limit position is now shown on the main scale Indicator.

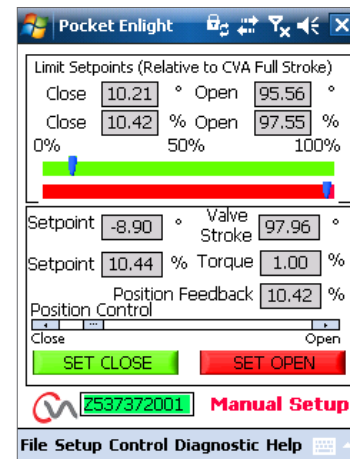

Fig 7.61

7.0 Installation & Setup Guide

Set Open Limit

Use the Position Control slider to move the actuator output shaft to the required Open position.

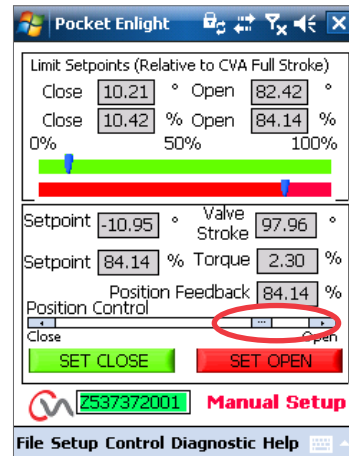

Fig 7.62

Click on the 'SET OPEN' box to calibrate the closed limit of travel. The 'Set OPEN' and the 'Serial' number boxes are 'greyed' out during the calibration procedure and indicate acceptance of the new settings when cleared.

The new open limit position is now shown on the main scale indicator.

The new limits of travel are shown on the green and red scales as degrees and percentages relative to the actuators full mechanical stroke.

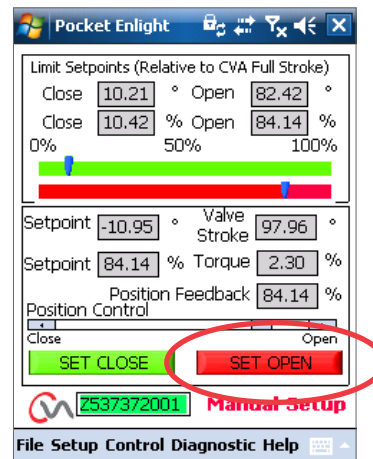

Fig 7.63

Manual Setup is now complete.

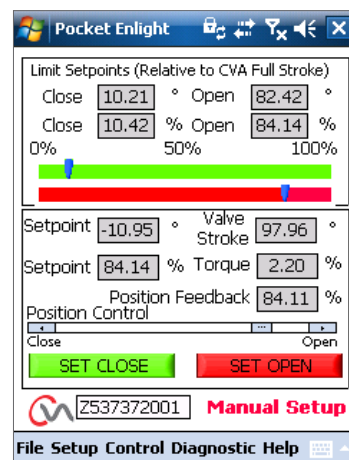
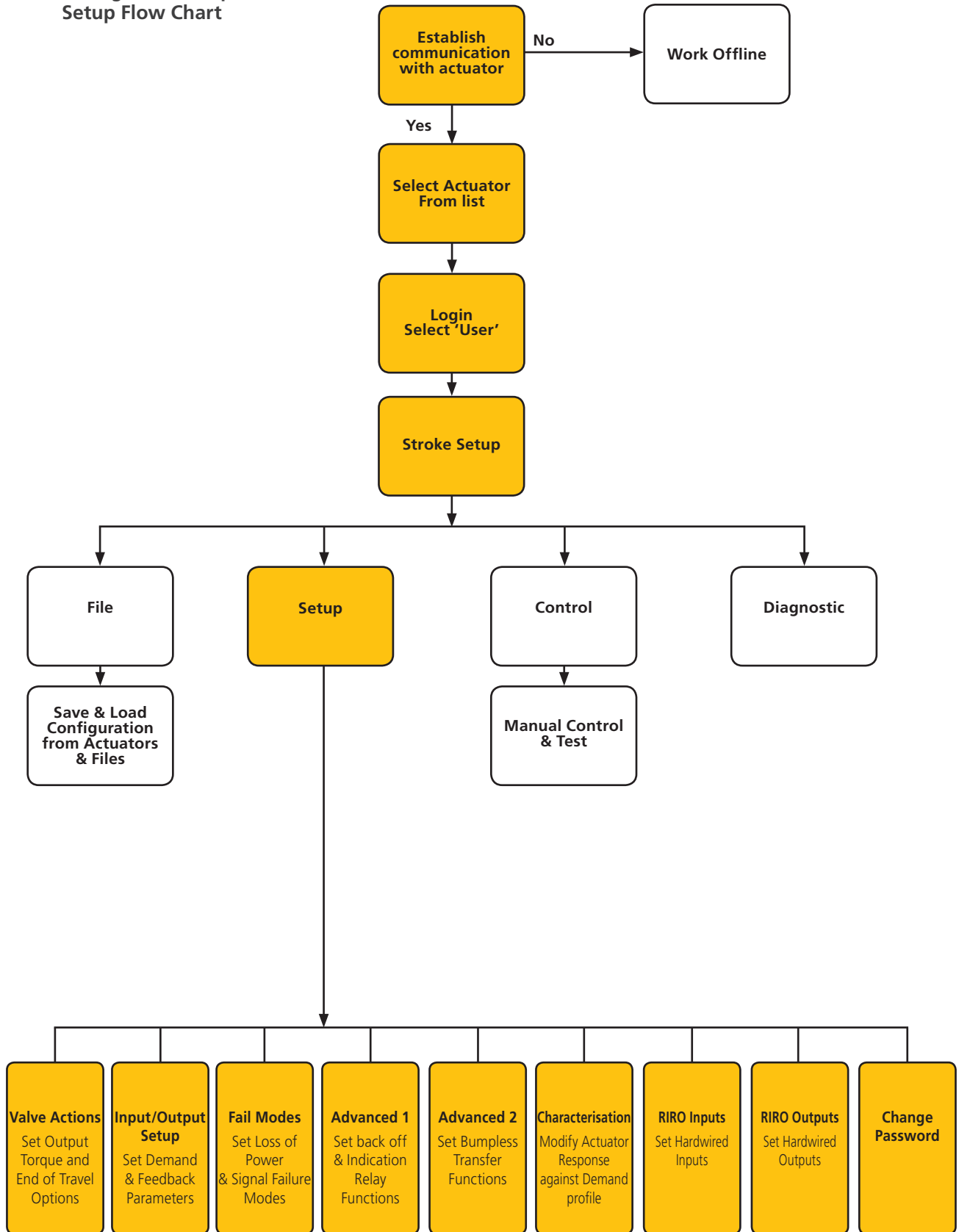

Fig 7.64

7.0 Installation & Setup Guide

7.14 Configurations Options Setup Flow Chart



7.0 Installation & Setup Guide

7.15 File

From the lower tool bar the file menus allow configuration settings to be stored and updated.

Load Config from CVA

This option will download the actuator configuration of the currently connected actuator to the PDA to allow verification of the settings.

The 'Transferring data' screen will be active during the download.

Save Config to CVA

Upload the current configuration stored from the PDA to the actuator.

The 'Transferring data' screen will be active during the download.

Load Config from File

VIEW

Use this screen to load a configuration file for review. On the PDA. This will disconnect the current actuator.

Macro Update

Use this option to run a Macro update.

The Macro update file is supplied directly from Rotork where specialist customer configuration is required.

Return to Process

Return actuator to process remote control.

Connect Actuator

Connect to another actuator.

UPDATE

Use this screen to update the current actuator with a previously saved file.

Configurations Options

Use this option to Save actuator configuration to the PDA or actuator memory.

Load configuration data from previously saved files from PDA to the actuator.



Fig 7.65



Fig 7.66

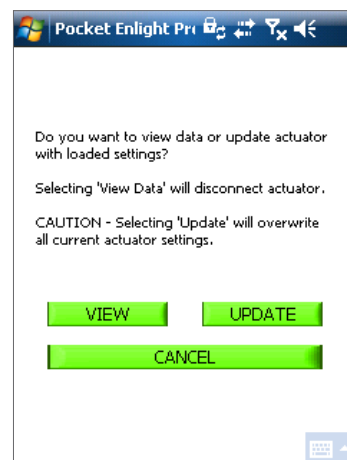

Fig 7.67

7.0 Installation & Setup Guide

Save Config to File

Save the current actuator configuration to a file location on the PDA.

Save config to file will open a new screen to save file in PDA. File will be identified by actuator serial number. This can be edited. The file location can also be selected from this screen.

Save will initiate the process.

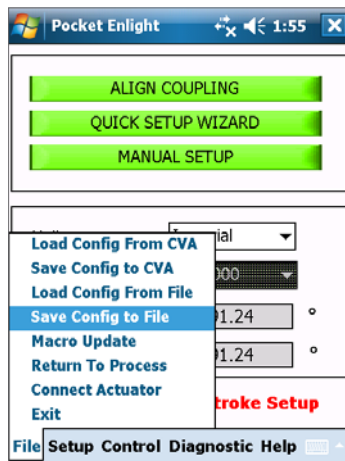

Fig 7.68

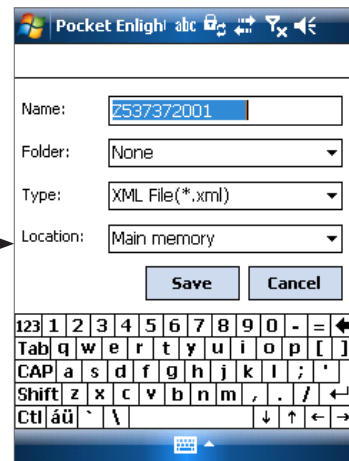

Fig 7.69

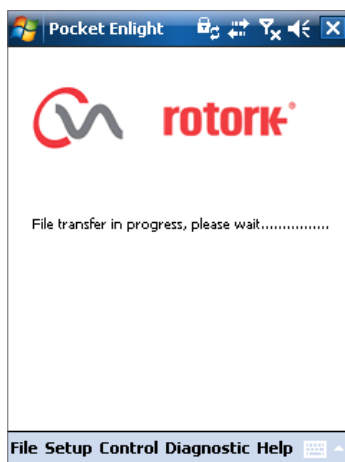

Fig 7.70

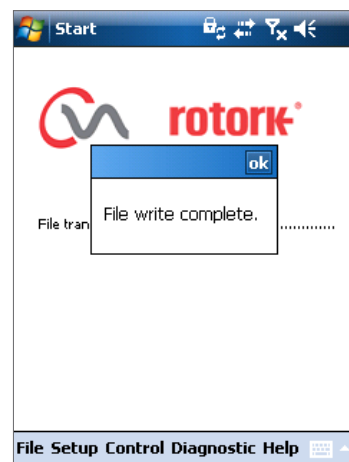

Fig 7.71

7.0 Installation & Setup Guide

7.16 Macro Update

ROTORK USE ONLY

No USER function.

Configuration Settings

Further menu options are available from the lower tool bar as follows:

7.17 Setup

Stroke Setup

Align Coupling
Quick Setup Wizard
Manual Setup

Valve Actions

Configure torque output options, direction to close and MOV tag.

Input/Output Setup

Configure analogue demand and feedback options.

Fail Modes

Configure power and loss of signal failure actions.

Advanced 1

Configure back off and status relay options.

Advanced 2

Configure bumpless transfer options.

Characterisation

Configure actuator response to demand characteristic.

RIRO Inputs

Configure hard-wired remote inputs (optional).

RIRO Outputs

Configure hard-wired remote outputs (optional).

Change Password

Change actuator password.

DO NOT lose the Password information if changed from the Default.

7.18 Control

Manual Control

Operate the actuator manually by *Bluetooth*® command.

Run Test

Run a selection of step and wave tests. Rotork use only.

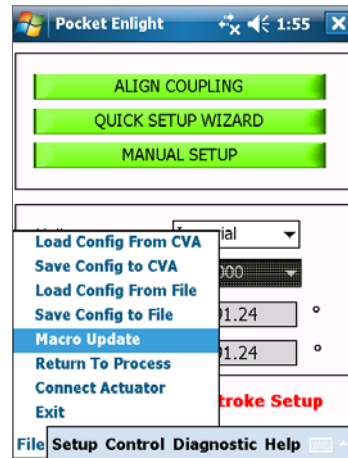

Fig 7.72

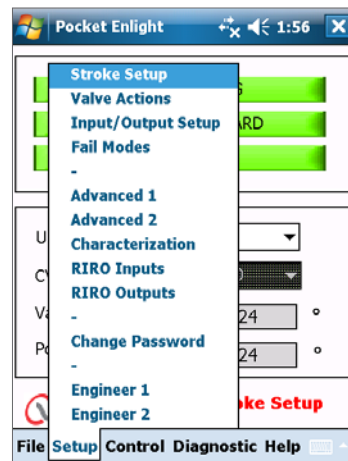

Fig 7.73

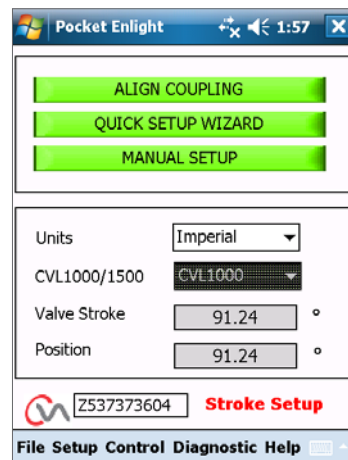

Fig 7.74

7.0 Installation & Setup Guide

7.19 Valve Actions

From the lower tool bar menu select **Valve Actions**.

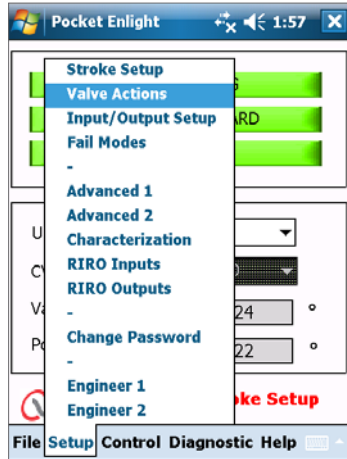

Fig 7.75

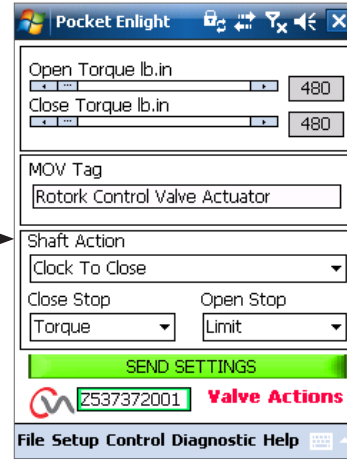

Fig 7.76

The following settings are available:

Open/Close Torque

Maximum allowed output torque can be varied between 40% to 100% of rated in both Open and Close directions.

The torque is displayed in lb.in or Nm.

MOV Tag

Modify as required.

Shaft Action

Clock or Anticlock to close (Clock is Default).

Close/Open Stop

Set the end of travel stop function for Torque or Limit to suit the characteristics of the valve.

Torque

The actuator can be set to apply its selected output 'Torque' to the valve at the end of travel where tight shut off is required.

Limit

Alternatively it can be set to the 'Limit' function to disengage motor drive, where the valve does not require the seating force to be applied.

Send Settings

Send modified settings to the actuator.

7.0 Installation & Setup Guide

7.20 Input / Output Setup

From the lower tool bar select **Input/Output Setup**.

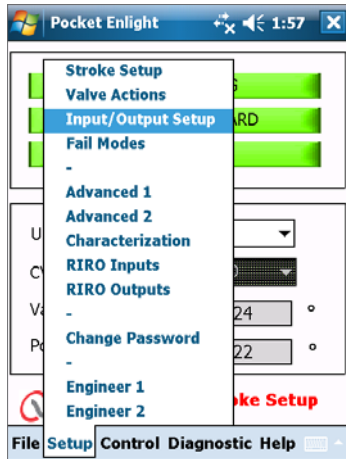

Fig 7.77

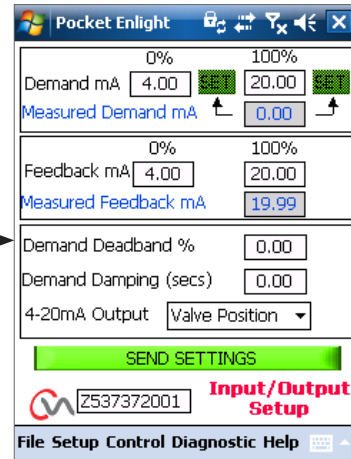

Fig 7.78

Close Demand mA Calibration

Set mA Demand level at fully Closed position.

Apply minimum (0%) Setpoint Signal to the actuator demand input terminals and use the appropriate 'SET' box to calibrate.

The setpoint will be calibrated to the Measured Demand mA value displayed in the box.

Open Demand mA Calibration

Set mA Demand level at fully Open position.

Apply maximum (100%) Setpoint Signal to the actuator demand input terminals and use the appropriate 'SET' box to calibrate.

The setpoint will be calibrated to the Measured Demand mA value displayed in the box.

Close Feedback mA Calibration

Set required mA Feedback level at the fully Closed position by typing in the value directly to the 0% Feedback box. Select **SEND** settings to save changes.

Open Feedback mA Calibration

Set required mA Feedback level at the fully Open position. By typing in directly to the 100% Feedback box. Select **SEND** settings to save changes.

Demand Deadband

If the actuator hunts or responds unnecessarily to a fluctuating setpoint signal, the Deadband may be increased. The Deadband can be varied between 0% and 10%.

Damping

If the actuator responds unnecessarily to a rapidly fluctuating setpoint signal the Damping feature can be used to 'damp' out the response by applying a delay in the response to a change in signal.

Adjust the damping time delay (milliseconds) setting to achieve stable system operation.

4-20 mA Output

Can be configured to show the actuator position or output torque.

Send Settings

Send modified settings to the actuator.

7.0 Installation & Setup Guide

7.21 Fail Modes

From the lower tool bar select **Fail Modes**.

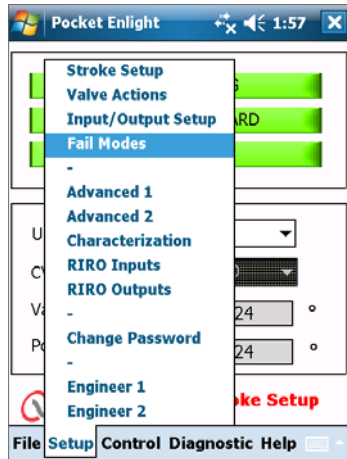

Fig 7.79

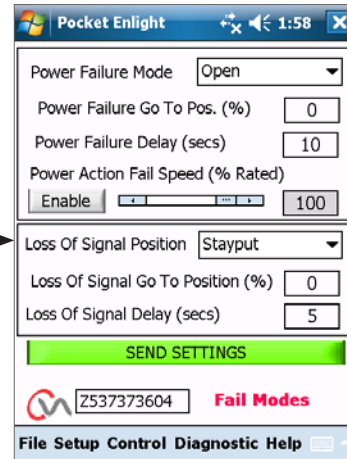

Fig 7.80

Power Failure Mode

(Units fitted with Reserve Power Pack option only).

On power failure the actuator can be set to carry out the following actions:

Move to Closed limit of travel

Move to Open limit of travel

Stayput

Go To Position

Power Failure Delay

Delay before failsafe action is adjustable up to a maximum of 10 seconds.

Power Action Fail Speed

Adjustable failsafe speed operation.

NOTE: The LED on the mode selector will remain illuminated until the Reserve Power Pack failsafe capacitors are fully discharged.

Only one failsafe action can be carried out after power failure.

No further electrical operation is possible until the power is re-instated.

Loss of Signal Position

On loss of the 4 - 20 mA analogue control signal the 'Fail to Position' can be set to carry out one of the following actions:

Move to Closed limit of travel

Move to Open limit of travel

Delay Fail to Position response up to 10 seconds

Move to a pre- determined position

7.0 Installation & Setup Guide

7.22 Advanced 1

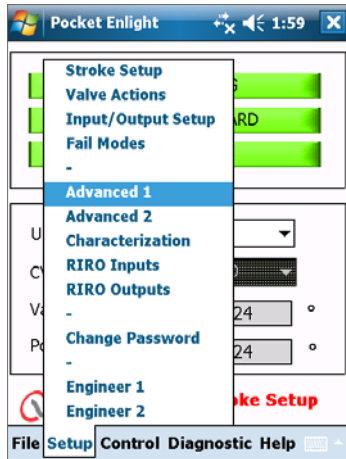

Fig 7.81

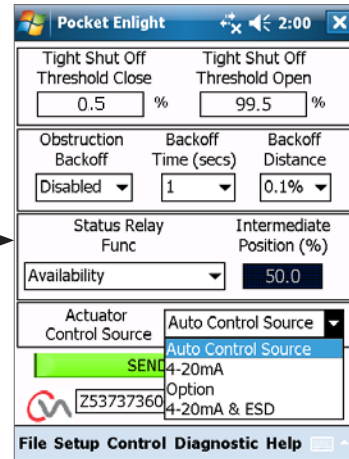

Fig 7.82

Tight Shut Off Threshold Close

This box indicates the highest level analogue mA setpoint as a percentage that will fully close (tight shut off) the valve.

The example shown in Fig 7.82 states that a 0.5% or lower control request will give a tight shut off (closed) on the valve.

Tight Shut Off Threshold Open

This box indicates the lowest level analogue mA setpoint as a percentage that will fully open the valve.

The example shown in Fig 7.82 states that a 99.5% or greater control request will give a tight shut off (open) on the valve.

Obstruction Back Off

If enabled the actuator will back off the movement if the maximum torque is exceeded during travel. The actuator will make 3 attempts to back off and return to the setpoint.

If disabled the actuator will remain stationary until a request to move in the opposite direction is received or the obstruction is removed.

Back Off Distance

The distance the actuator backs off can be selected on the drop down menu as shown.

Back Off Time

Can be set to a maximum of 5 seconds before back off is executed.

Actuator Remote Control Source

Auto Control Source -	Automatically detects Remote Control Source
4-20 mA	Analogue Control Only
Option	Hard-wired or Bus System Remote Control depending on fitted Option
4-20 mA & ESD	Analogue and Hard-wired ESD Remote Control

7.0 Installation & Setup Guide

7.22.1 Status Relay

The actuator has a programmable fault relay that can be set to indicate one of the following conditions shown in Table 3.

Mode	Description
Disabled	Always de-energised to reduce power consumption
Availability	Active when the CVA is capable of being remotely controlled Actuator is in Remote Mode Actuator has no faults which would prevent operation
Fault	Active with any detectable fault within the actuator, control or valve
Open Limit	Active when the actuator is at the Fully Open position
Closed Limit	Active when the actuator is at the Fully Closed position
Open Torque Limit	Active when the actuator has reached the Opening Torque Limit
Close Torque Limit	Active when the actuator has reached the Closing Torque Limit
Torque Limit	Active when the actuator has reached the Opening or Closing Torque Limit
Failsafe	Active when the actuator is performing its Failsafe action
Supercap Pwr	Reserve Power Pack status
Blinker	Blinker output
Intermediate Position	Set to intermediate position
Supercap fault	Reserve Power Pack failure

Table 3

The relay function can be configured for Normally Open or Closed operation. Must be carried out before despatch from the factory.

See Table 3 for details of relay functions.

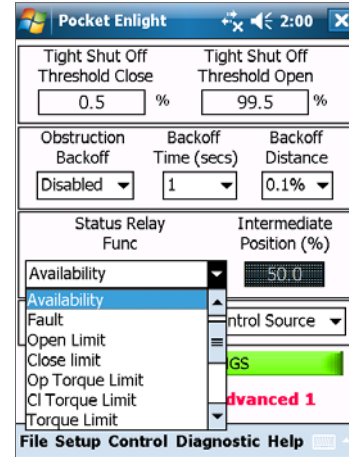

Fig 7.83

7.0 Installation & Setup Guide

7.23 Advanced 2

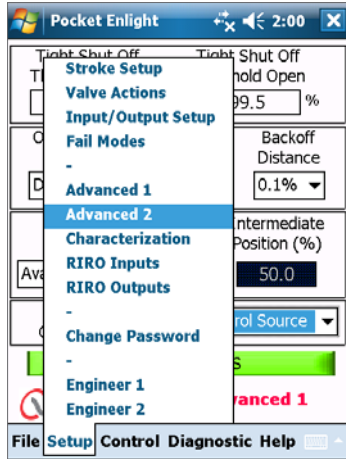

Fig 7.84

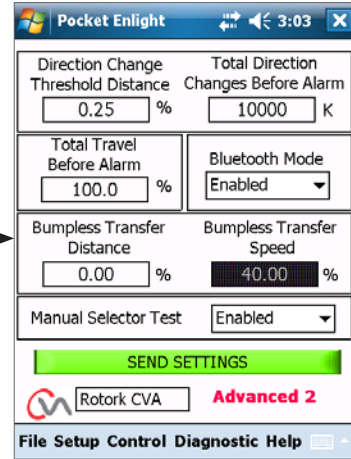

Fig 7.85

Direction Change Threshold Distance

The distance the actuator must move before a direction change is registered by the datalogger as a cycle.

This is used to prevent small dither movements from being counted as these are considered too small to cause valve wear.

The default setting is 0.25% of overall valve travel.

Total Direction Changes Before Alarm

Can be used to generate an alarm when a set number of direction changes has occurred.

Total Travel Before Alarm

Can be used to generate an alarm when a set distance has been travelled by the actuator output drive shaft ft/meters.

Bluetooth® Mode

Enabled - Actuator always discoverable by *Bluetooth*

Disabled - Actuator only discoverable when 'STOP'.

Bumpless Transfer

On start up of the process or after manual intervention the actuator could be required to move a long way to its setpoint. If the actuator moved at too great a speed this could cause a 'bump' or instability in the control system loop leading to valve overshoot and oscillation.

To reduce this effect the 'bumpless transfer' reduces the actuator output speed to a lower level if the distance to travel is more than a pre-determined value. Once the actuator arrives within the Bumpless Transfer Distance (BTD) area it will resume travel at its normal speed.

Bumpless Transfer Distance (BTD)

The bumpless transfer distance is a pre defined percentage of position error that will reduce the actuator speed to a pre-determined speed.

The default Bumpless Transfer Distance is 5%.

Bumpless Transfer Speed

The speed in % of rated maximum speed that the actuator will revert to if the bumpless transfer distance is exceeded.

The actuator will resume normal set speed once it arrives within the preset BTD.

The default Bumpless Transfer Speed is 40% of rated.

Manual Selector Test

The Mode selector knob can be disabled to prevent the actuator carrying out a pre-determined test routine when the 'TEST' position is selected.

Send Settings

Upload the Advanced 2 configuration changes to the actuator.

7.0 Installation & Setup Guide

7.24 Characterisation

The relationship between the demand input signal and the actuator position is Linear by default. The profile can be modified to suit the characteristic of the valve.

Use the Valve Characteristic drop down menu to select between the following:

Linear

The actuator position responds directly to the mA demand request.

Quick Opening

The actuator responds proportionately greater than the demand signal at the lower end of travel. Reduced response near the open position.

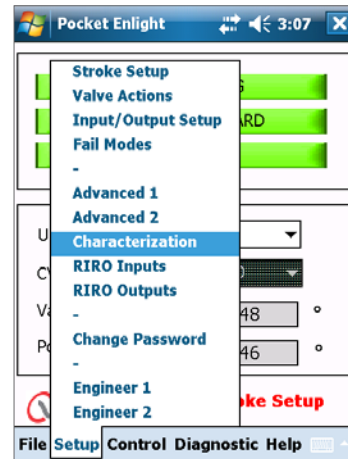

Fig 7.86

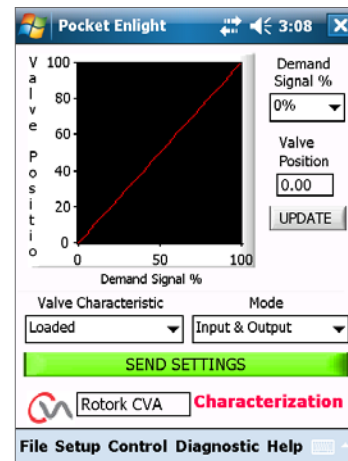

Fig 7.87

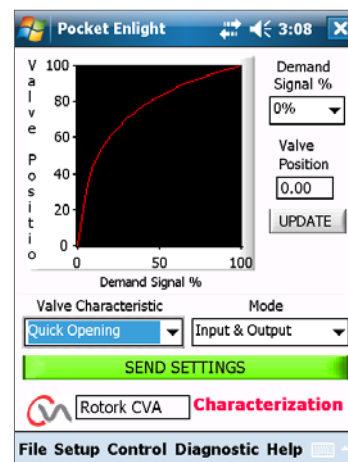

Fig 7.88

7.0 Installation & Setup Guide

Equal Percentage

The change in actuator position is directly proportional to the change in the demand request.

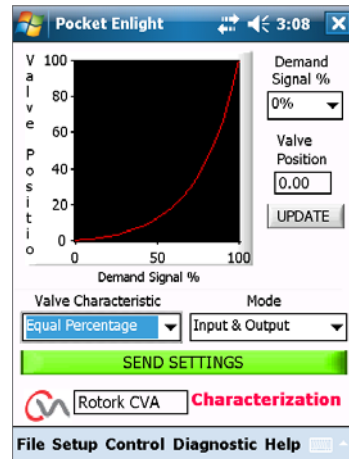

Fig 7.89

Valve Position & Demand Signal

The position against demand profile can be tailored to suit the valve application by plotting the characteristic at up to 20 co-ordinate points on the graph.

Click on the Valve Position box and highlight the required valve position (5% increments).

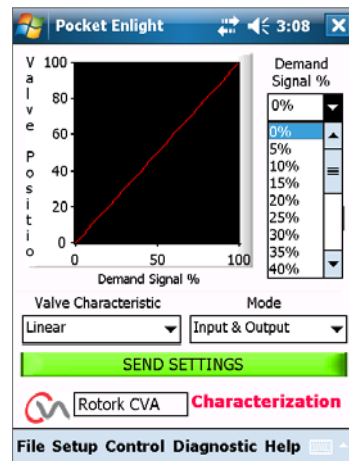

Fig 7.90

Type in the corresponding Desired Signal % and click on the Update box.

Use the update box to store the co-ordinate point.

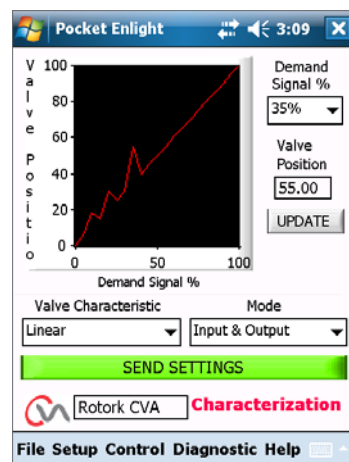

Fig 7.91

7.0 Installation & Setup Guide

Mode

The characteristic Profile can be applied to both the Input and Output signals or individually if required.

Click on the **SEND SETTINGS** box to save the changes to the actuator configuration.

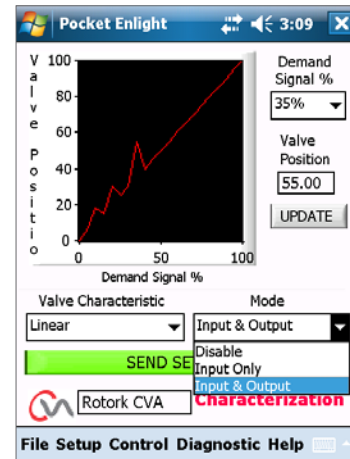

Fig 7.92

7.25 RIRO (Remote Inputs & Remote Outputs)

The RIRO option card gives up to four hard-wired control inputs or four extra relay contacts. The options must be selected at time of purchase.

Note: Consult the actuator wiring diagram to determine which options are supported in the actuator.

7.25.1 RIRO Inputs (optional)

When fitted the RIRO hardwired remote control inputs can be configured as follows.

Active State

High Normally Open contact **Make** to apply signal.

Low Normally Closed contact **Break** to apply signal.

Function

Can be set to ONE of the functions below:

- Open Command
- Closed Command
- Stop/Maintain active
- ESD Command
- TEST - Perform test routine

Energised / Deenergised Delay

The hard-wired remote control inputs can be configured to delay response by up to 1 second to energise/de-energise.

Digital Input Voltage Type

RIRO Inputs can be selected for DC or AC operation.

ESD

Emergency shutdown operation can be set to one of the following:

- Move to Close Limit
- Stop (Stayput)
- Move to Open limit

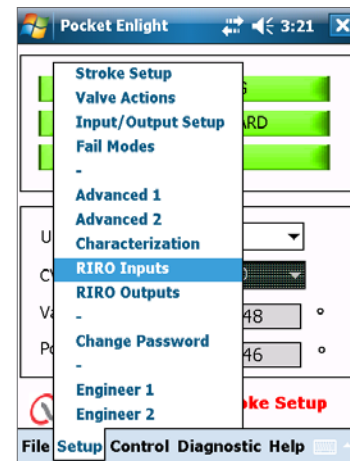

Fig 7.93

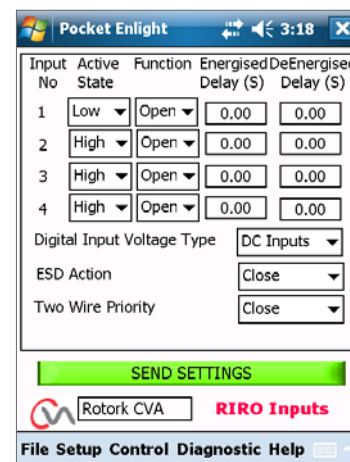

Fig 7.94

7.0 Installation & Setup Guide

7.25.2 RIRO Relay Outputs (optional)

Up to four remote indication relays can be fitted.

When fitted the RIRO hardwired indication relay outputs can be configured for Normally Open or Normally Closed contact form.

The relays can be programmed for one of the following functions:

Availability

Fault

Open Limit

Close Limit

Open Load Limit (Exceeded)

Close Load Limit (Exceeded)

Load Limit

SuperCap Power

Intermediate Position

Actuator Closing

Actuator Opening

Motor Running

Actuator Moving

Motor Stalled

Hand Operation

Blinker

Local Stop Selected

ESD Signal Present

Relay Parity

Mains Failure

Monitor Relay

Run Selected

Test Selected

Test Failed

Supercap Failure

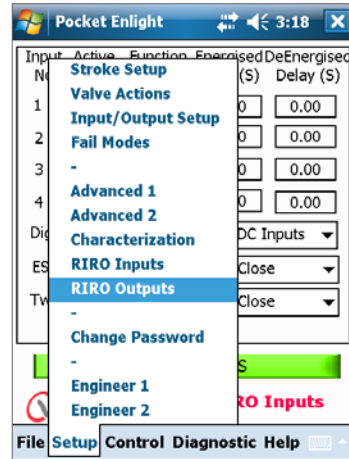

Fig 7.95

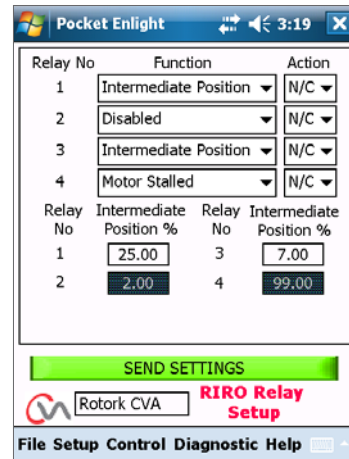

Fig 7.96

7.0 Installation & Setup Guide

7.26 Change Password

This menu allows the actuator password to be changed.

Note: If the actuator Password is changed it will not be possible to communicate with the unit, unless the correct password is used.

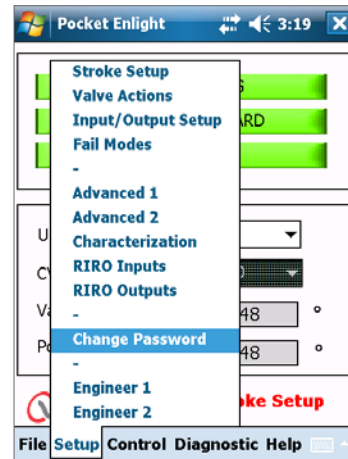

Fig 7.97

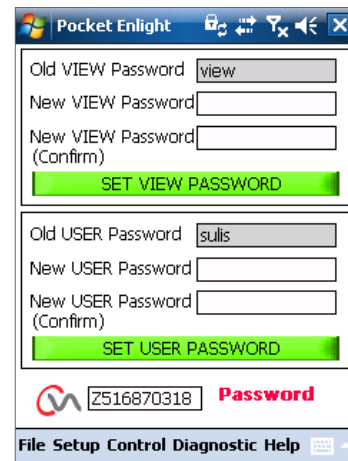

Fig 7.98

If the incorrect password is entered an error message will be displayed.

The actuator password cannot be reset. An error code will be generated, make a note of the code then please contact your local Rotork representative stating the full error code.

The actuator's current password may then be verified and confirmed.

DO NOT LOSE THE PASSWORD INFORMATION.

CONTACT ROTORK IN CASE OF LOST PASSWORD INFORMATION.

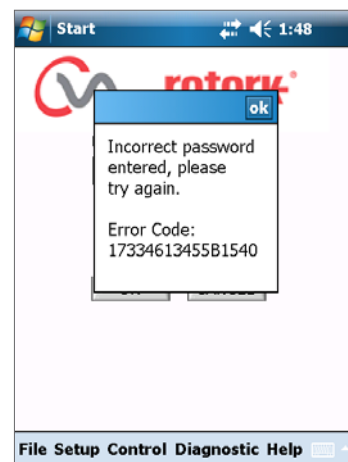
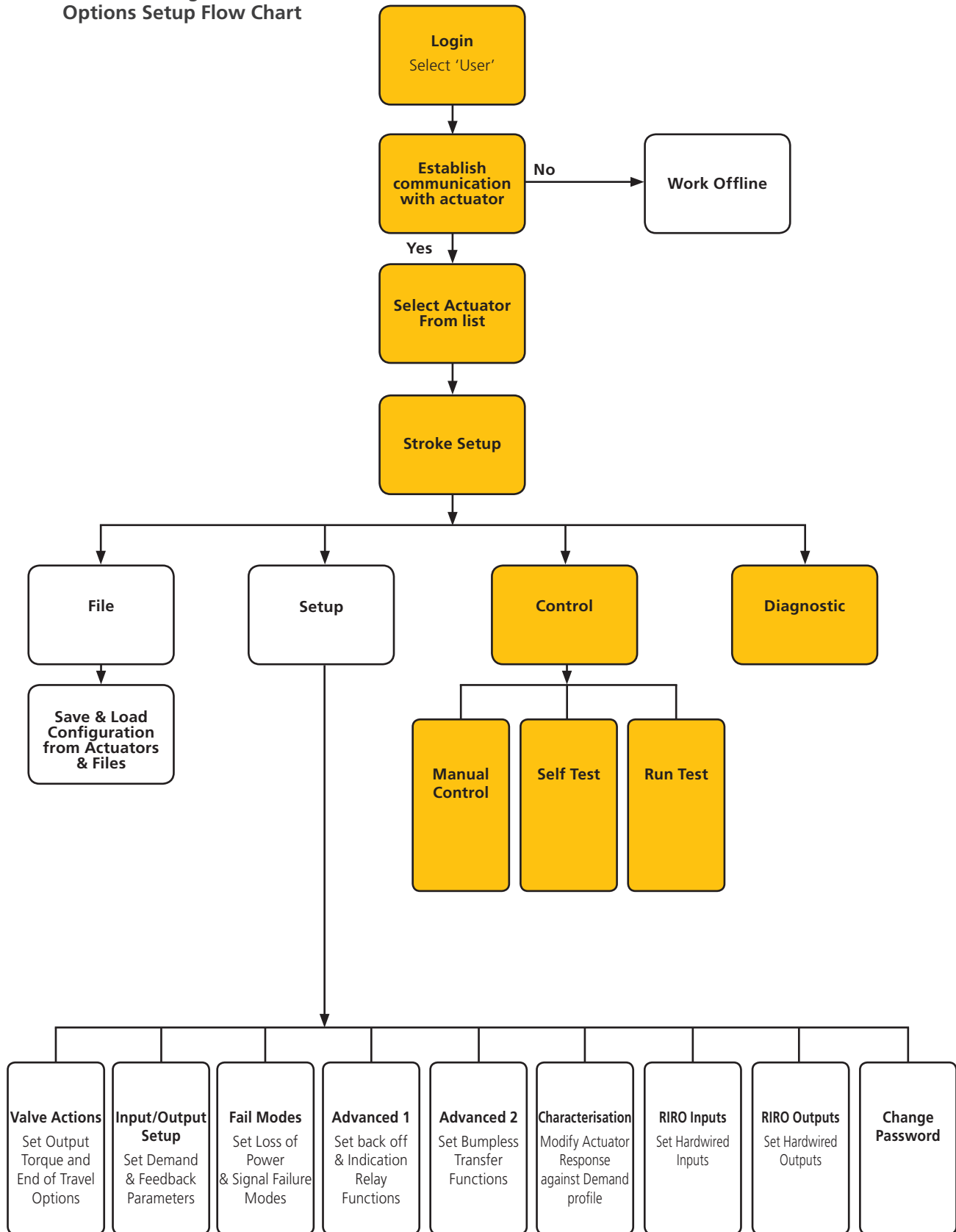

Fig 7.99

7.0 Installation & Setup Guide

7.27 Control & Diagnostics Options Setup Flow Chart



7.0 Installation & Setup Guide

7.27.1 Manual Control

Move and test the function of the actuator locally using the PDA independently of the control system.

Any changes to the actuator setup or position will be confirmed prior to being implemented.

Position Control

Use the slider (Coarse or Fine) to position the valve.

Note any manual request to move will put the actuator offline and will override any system commands.

Click on 'OK' to initiate manual override.

Setpoint & Feedback

Displayed as position and percentage the Setpoint and Feedback are updated continuously during actuator movement.

Valve Stroke

Indicated as distance between the set limits of travel.

Close Limit

Illuminated at closed end of travel.

Open Limit

Illuminated at Open end of travel.

Rated Speed

Output shaft speed is variable between 5% and 100% of rated speed.

Measured Torque

The Measured Torque is a live indication of effort required during valve travel.

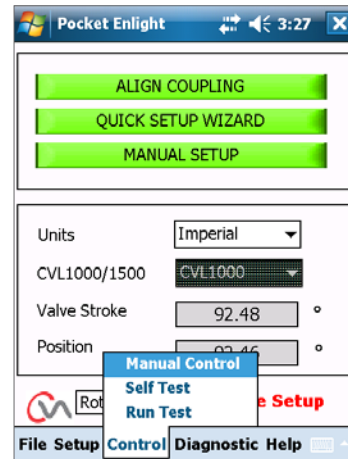

Fig 7.100

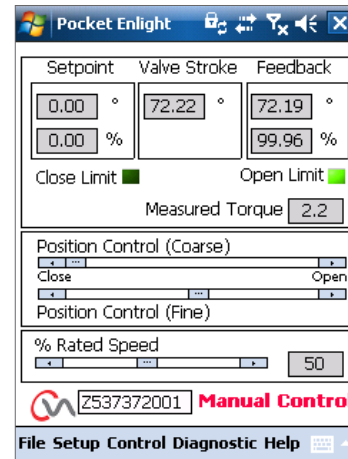

Fig 7.101

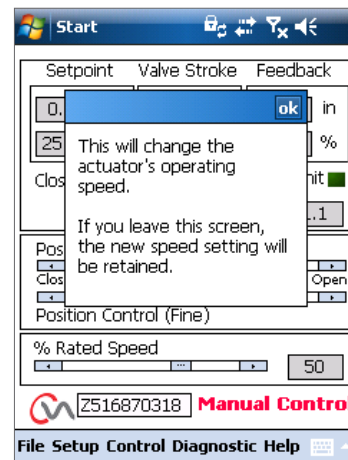

Fig 7.102

7.0 Installation & Setup Guide

7.2.2 Self Test

Actuator will carry out a Self Test routine on its Torque and Position measurement systems.
Status and Parameters are displayed at the end of test.

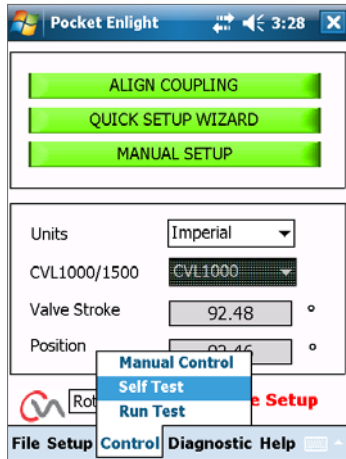

Fig 7.103

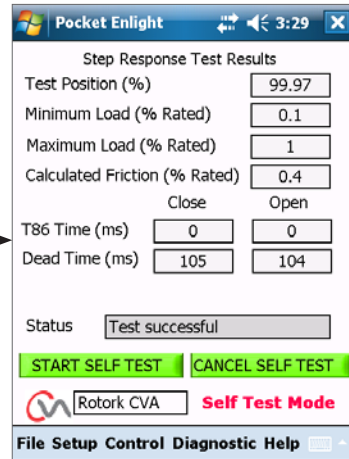

Fig 7.104

Note

Run Test is a Rotork only function.

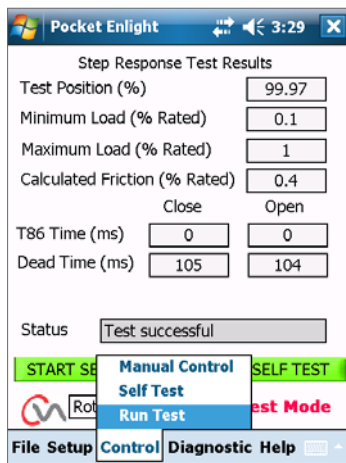

Fig 7.105

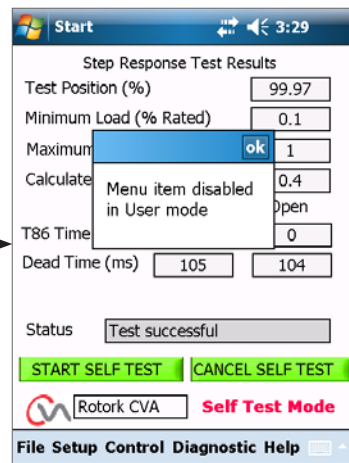

Fig 7.106

7.0 Installation & Setup Guide

7.28 Diagnostic Menus

7.28.1 Datalogger

The datalogger function is used to download historical data from the actuator for review on a PDA or PC.

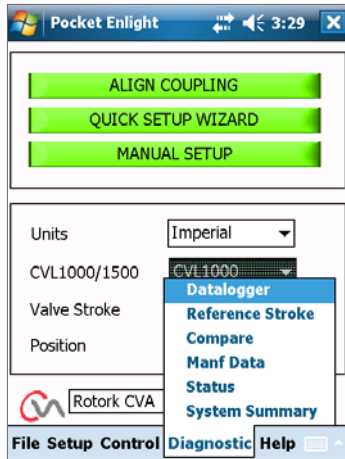

Fig 7.107

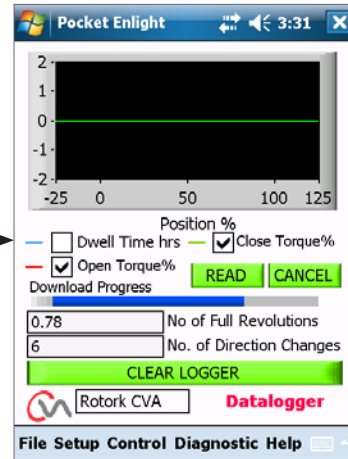

Fig 7.108

The data logger page graph can display open/close torque and dwell time. Dwell time is total time spent at any position during the valve stroke.

To download a file click on **READ**.

Note: Only open one graph at a time as this can affect the scaling.

Other data available is total number of full revolutions travelled and number of direction changes.

The data logger file can be stored in the PDA memory for future reference.

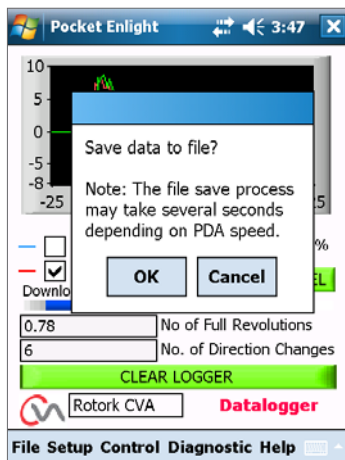

Fig 7.109

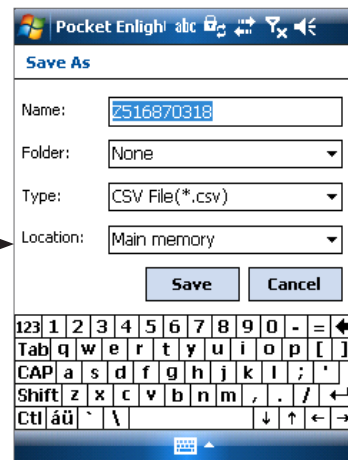

Fig 7.110

7.0 Installation & Setup Guide

7.28.2 Reference Stroke

When the actuator has been commissioned it is possible to set a reference stroke to record torque. This can be compared against a current recording to determine if any parameters have changed.

SET REFERENCE STROKE

Will record the last valve stroke for future reference.

READ REFERENCE STROKE

Displays the reference stroke on the graph against the current performance.

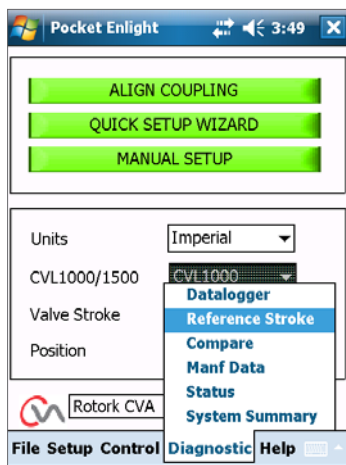

Fig 7.111

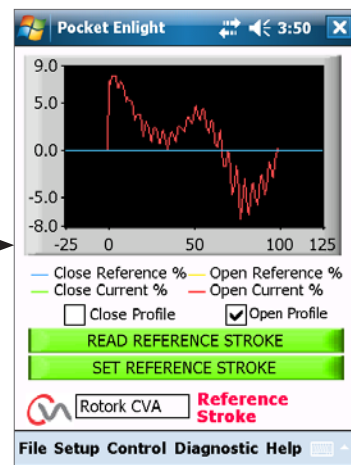

Fig 7.112

7.0 Installation & Setup Guide

7.28.3 Compare

If a configuration file has previously been saved it can be compared to the current settings.

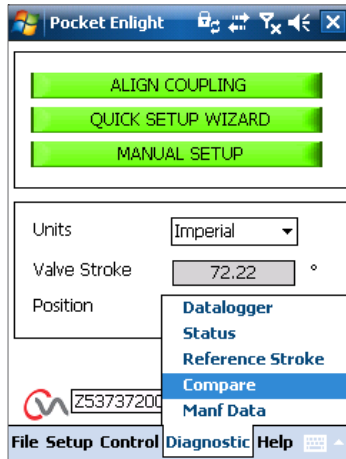

Fig 7.113

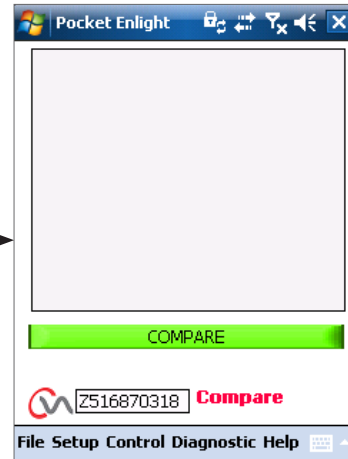

Fig 7.114

When the compare screen appears click onto the compare box and you will be prompted to find a previously stored configuration file. When the file is opened a list will be generated showing any modifications to the settings since the original file was created.

Fig 7.116 shows that the previous change was to increase the speed from 50% to 71% rated.

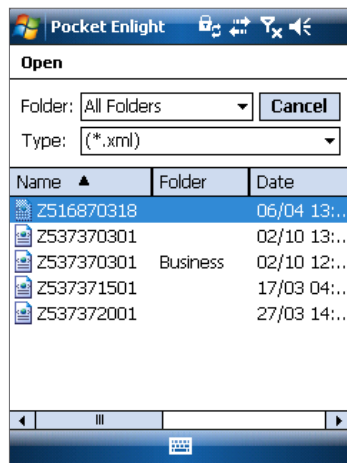

Fig 7.115

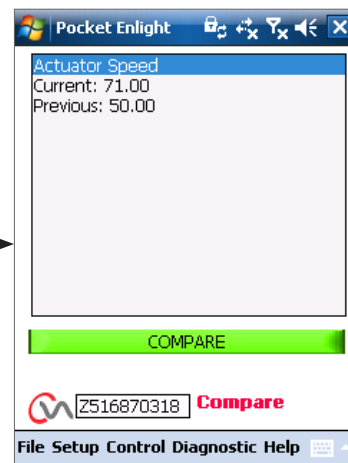

Fig 7.116

7.0 Installation & Setup Guide

7.28.4 Manufacture Data

Display manufacturing data including software version and serial numbers.

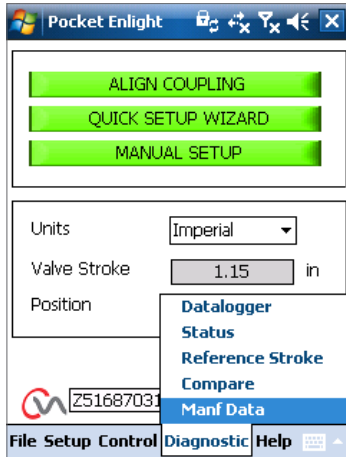

Fig 7.117

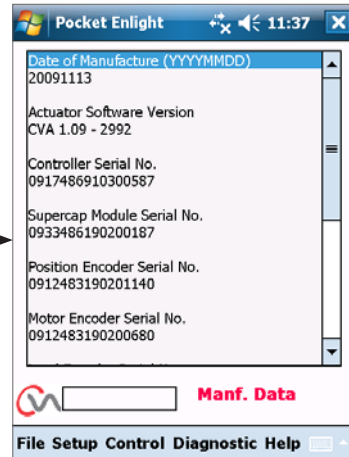

Fig 7.118

7.28.5 Status

Active alarms and status are displayed.

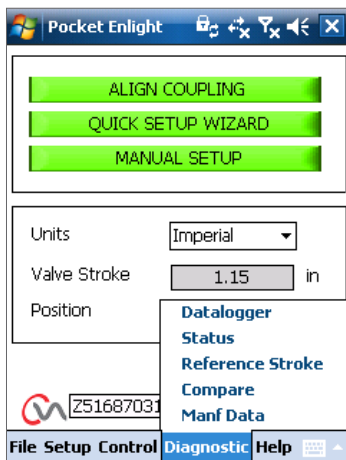

Fig 7.119

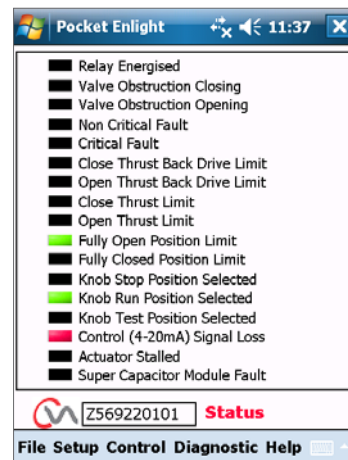

Fig 7.120

7.0 Installation & Setup Guide

7.28.6 System Summary

Status and health of actuator system and options is displayed.

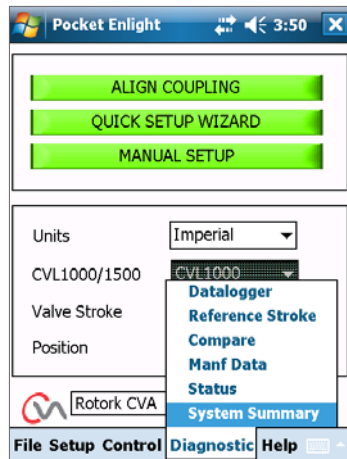

Fig 7.121

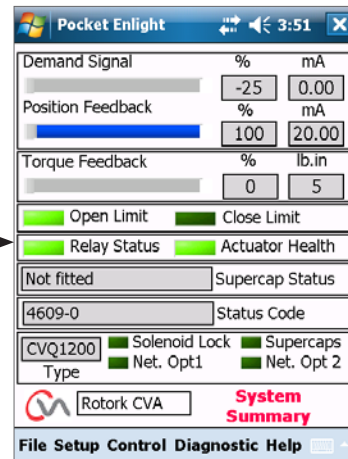

Fig 7.122

8.0 Rotork Sales and Service

If your Rotork actuator has been correctly installed and sealed, it will give years of trouble-free service.

Should you require technical assistance or spares, Rotork guarantees the best service in the world. Contact your local Rotork representative or the factory direct at the address on the nameplate, quoting the actuator type and serial number.

Local representative:

rotork®

Keeping the World Flowing



www.rotork.com

A full listing of our worldwide sales and service network is available on our website.

Rotork plc
Brassmill Lane, Bath, UK
tel +44 (0)1225 733200
fax +44 (0)1225 333467
email mail@rotork.com

Rotork is a corporate member of the Institute of Asset Management



PUB042-004-00
Issue 08/17

Original instructions: English language version only. As part of a process of on-going product development, Rotork reserves the right to amend and change specifications without prior notice. Published data may be subject to change. For the very latest version release, visit our website at www.rotork.com
The name Rotork is a registered trademark. Rotork recognises all registered trademarks. Published and produced in the UK by Rotork Controls Limited. POWDG0817