

Bi-Metallic Steam Traps

The **WPN Series Bi-Metallic Steam Traps** are used in steam tracing, steam main drips and non-critical process equipment. They can be used on outdoor applications that are subject to freezing. The WPN Series Traps are available in multiple sizes and pressures up to 2260 PSI.

Model	Body Material	PMO (PSIG)	Sizes	Connections	Pressure Controller	Max Diff. Pressure (PSI)
WPN-40	A105 Carbon Steel	470	1/2" - 2"	NPT, 150# or 300# FLG, SW, BW	R22	320
					R32	460
WPN-63	A182-F12CL2 Alloy Steel	823	1/2", 3/4", 1"	NPT, 300# FLG, SW, BW	R56	810
WPN-100	A182-F12CL2 Alloy Steel	1220	1/2", 3/4", 1"	NPT, 600# FLG, SW, BW	R90	1200
WPN-160	A182-F12CL2 Alloy Steel	1620	1/2", 3/4", 1"	NPT, 900# FLG, SW, BW	R130	1600
WPN-250	A182-F22CL3 Alloy Steel	2260	1/2", 3/4", 1"	NPT, 1500# FLG, SW, BW	R150	2230

Typical Applications

DRIP, TRACING: WPN Series Bi-metallic steam traps are used in steam tracing, steam main drips and non-critical process equipment. They are extremely robust and reliable, making them a suitable choice for high

pressure applications as well as outdoor applications that are subject to freezing. They are used in systems where a quick discharge of air, non-condensable gases and large quantities of cold water need to be discharged at start-up.

How It Works

When the system is cold, the trap is fully open; discharging air and cold condensate. When the bi-metallic plates inside the trap heat up, they expand; pulling the seat closed and restricting flow. Prior to steam temperature being reached, the trap shuts off tightly. Cooler temperatures cause the seat to open further. Therefore, trap capacity will increase when colder condensate is in contact with the Bi-metal element. Trap capacity is therefore given at different temperatures below saturated steam temperature.

Features

- Excellent for high-pressure and superheated steam applications
- Freeze-proof and resistant to waterhammer
- Suitable for superheated steam
- In-line repairable
- Trap can be welded into line

Sample Specification

Steam trap shall be Watson McDaniel WPN Series Bi-Metallic Steam Trap. Trap must be capable of being completely serviced while still in-line.

Installation and Maintenance

The trap can be installed in any orientation except with the cap facing downward. All internal components can be replaced while trap body remains in-line.

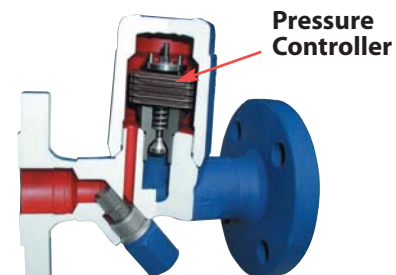

Max Differential Pressure for Pressure Controller	
Pressure Controller	Max Diff. Pressure PSI
R22	320
R32	460
R56	810
R90	1200
R130	1600
R150	2230

How to select a A WPN Trap:

- 1) Select a Pressure Controller that has a max differential pressure within the range of your application.
- 2) Select a Trap Body depending on System Pressure; WPN40 thru WPN250.
- 3) Select Connection Type & Size
- 4) Configure Model Code (see Examples to right)

Example Model Codes:

WPN40-A-R22-14-F150-ES

(Model WPN40, 320 PSI Max Differential Pressure, 1" 150# Flanged with External Strainer)

WPN63-C-R56-14-F600

(Model WPN63, 810 PSI Max Differential Pressure, 1" 600# Flanged with Standard Internal Strainer)

Model Configuration Chart

Position 1	Position 2	Position 3	Position 4		Position 5	Position 6
Model	Body Material (Code)	Pressure Controller Code	Connection Size	Code	Connection Type Code	Strainer Selection Code
WPN-40	Carbon Steel A105 (A)	R22 or R32	1/2"	12	F150, F300, N, SW	Internal Strainer (IS)
			3/4"	13		
			1"	14		
			1 1/2"	16		
			2"	17		
			1/2"	12	F150, F300, N, SW, BW	External Strainer (ES)
			3/4"	13		
			1"	14		
			1 1/2"	16		
			2"	17		
WPN-63	Alloy Steel A182-F12CL2 (C)	R56	1/2"	12	F300, SW, BW	
			3/4"	13		
			1"	14		
WPN-100	Alloy Steel A182-F12CL2 (C)	R90	1/2"	12	F600, SW, BW	
			3/4"	13		
			1"	14		
WPN-160	Alloy Steel A182-F12CL2 (C)	R130	1/2"	12	F900, SW, BW	
			3/4"	13		
			1"	14		
WPN-250	Alloy Steel A182-F22CL3 (C)	R150	1/2"	12	F1500, SW, BW	
			3/4"	13		
			1"	14		

Model	WPN-40	
Sizes	1/2", 3/4", 1", 1 1/2", 2"	
Connections	NPT, 150# FLG, 300# FLG, SW, BW	
Body & Cover Material	A105 (C22.8)	
PMA ANSI Class 150 with 150# FLG	190 PSIG up to 437°F	
PMA ANSI Class 300 with 300# FLG	460 PSIG up to 772°F	
TMO Max. Operating Temperature (°F)	Approx. 100°F Superheat	
Pressure Controller	R22	R32
PMO Max. Operating Differential Pressure of Pressure Controller (PSI)	320	460

Note: SW = Socket Weld
 BW = Butt-Weld

- 1) = 18°F SUB-COOL
- 2) = 54°F SUB-COOL
- 3) = 68°F

The capacity charts show the maximum flow at factory setting.

Curve 1 Flow of Condensate at approx. 18°F below boiling temperature.

Curve 2 Flow of Sub-Cooled Condensate at approx. 54°F below boiling temperature.

Curve 3 Flow of Cold Condensate at about 68°F (during start-up of a cold system).

Cooler temperatures cause the seat in the controller to open wider; therefore, trap capacity will increase when colder condensate is in contact with the Bi-metal element. Trap capacity is given at different temperatures below saturated steam temperature

WPN-40 with R22 & R32 Controller
 1/2", 3/4", 1"

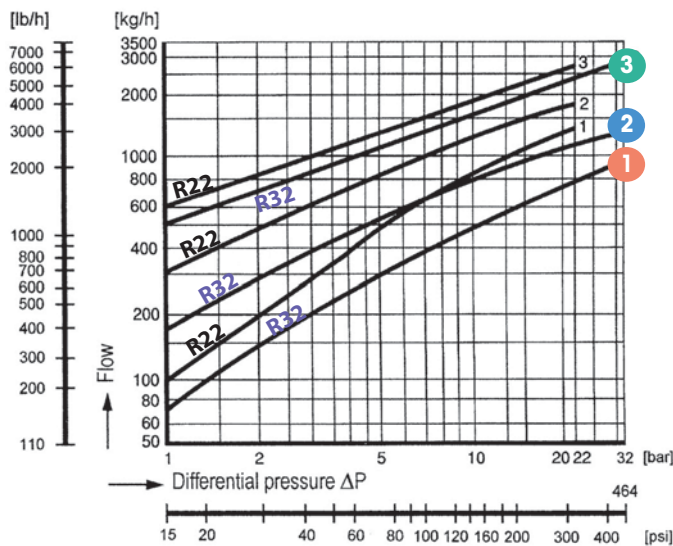

WPN-40 with R22 & R32 Controller
 1 1/2", 2"

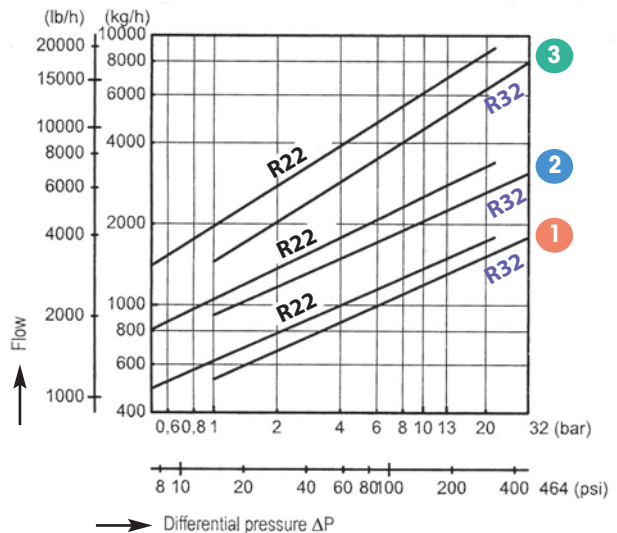

WPN-40 with R22 or R32 Controller (screw-on cover)

1/2", 3/4", 1"

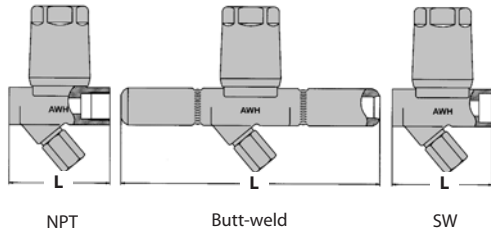
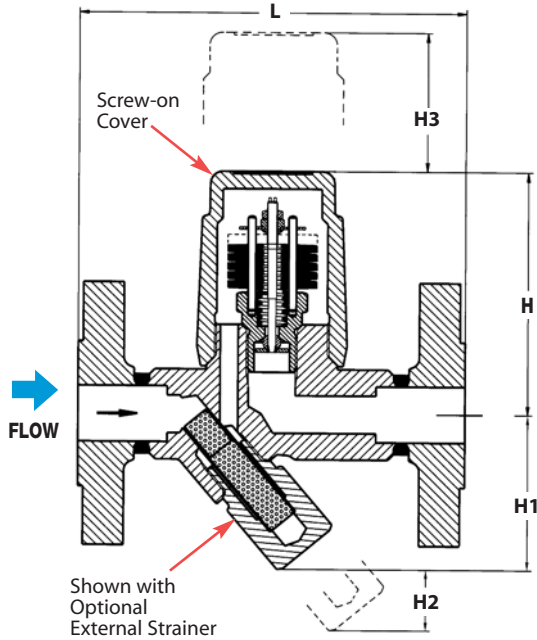

WPN-40 with R22 or R32 Controller (bolt-on cover)

1 1/2", 2"

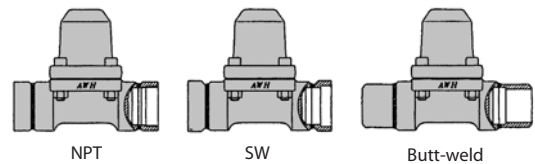
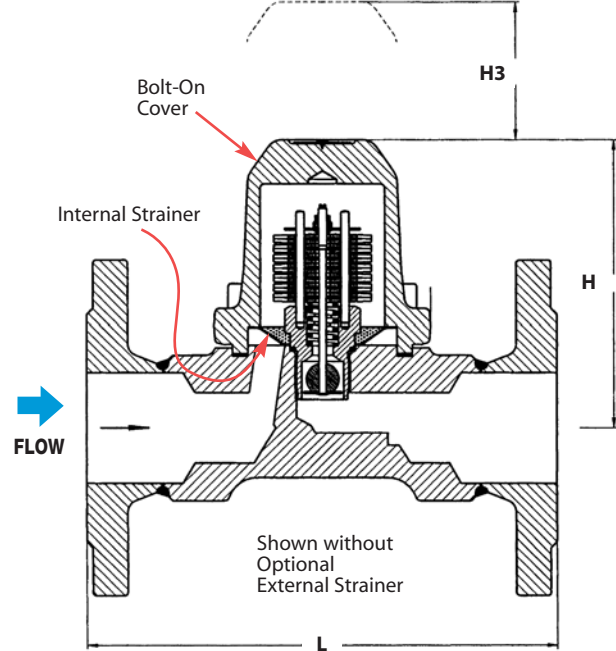

DIMENSIONS & WEIGHTS – inches

Model	Size	Connection	L	H	H1	H2	H3	Weight (lbs)
WPN-40	1/2", 3/4"	150#/300# FLG	5.90	3.92	2.44	1.20	2.8	7.7
	1"	150#/300# FLG	6.30	3.92	2.44	1.20	2.8	9.2
	1 1/2", 2"	150#/300# FLG	9.05	5.76	2.67	1.97	3.6	25.0
	1/2", 3/4"	NPT, SW	3.74	3.92	2.44	1.20	2.8	3.7
	1"	NPT, SW	3.74	4.12	2.16	1.20	2.8	4.6
	1 1/2"	NPT	6.30	5.76	2.67	1.97	3.6	17.6
	1 1/2"	SW	5.12	5.76	2.67	1.97	3.6	17.6
	2"	NPT, SW	8.27	5.76	2.67	1.97	3.6	17.6
	1/2", 3/4", 1"	Butt-weld	9.84	3.92	2.44	1.20	2.8	5.0
	1 1/2", 2"	Butt-weld	9.84	5.76	2.67	1.97	3.6	21.0

Model	WPN-63*	WPN-100	WPN-160	WPN-250
Sizes	1/2", 3/4", 1"	1/2", 3/4", 1"	1/2", 3/4", 1"	1/2", 3/4", 1"
Connections	300# FLG, SW, Butt-weld	600# FLG, SW, Butt-weld	900# FLG, SW, Butt-weld	1500# FLG, SW, Butt-weld
Body & Cover Material	Alloy Steel (A182-F12CL2)	Alloy Steel (A182-F12CL2)	Alloy Steel (A182-F12CL2)	Alloy Steel (A182-F22CL3)
Body Rating	ANSI 400	ANSI 600	ANSI 900	ANSI 1500
PMA Max. Allowable Pressure	810 PSIG up to 592°F	1200 PSIG up to 610°F	1600 PSIG up to 750°F	2180 PSIG up to 905°F
TMA Max. Allowable Temperature	1000°F @ 261 PSIG	1000°F @ 441 PSIG	1000°F @ 595 PSIG	1000°F @ 1305 PSIG
TMO Max. Operating Temperature	572°F	842°F	932°F	932°F
Pressure Controller	R56	R90	R130	R150
PMO Max. Operating Diff. Pressure of Pressure Controller	810 PSI	1200 PSI	1600 PSI	2230 PSI

WPN-63 / WPN-100 / WPN-160 / WPN-250

1/2", 3/4", 1"

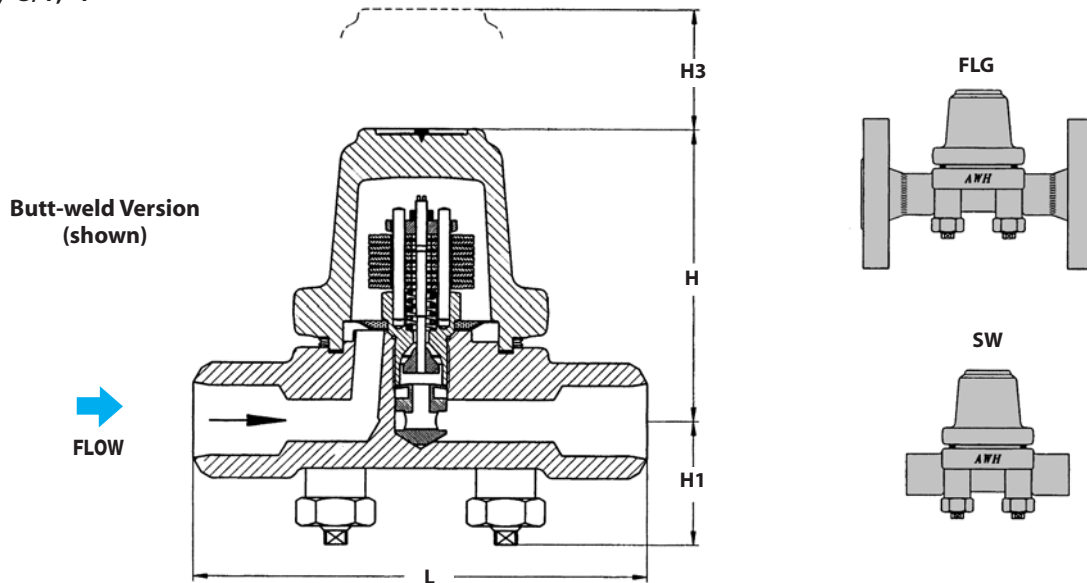

DIMENSIONS & WEIGHTS – inches							
Model	Size	Connection	L	H	H1	H3	Weight (lbs)
WPN-63, WPN-100, WPN-160, WPN-250	1/2", 3/4"	FLG*	8.26	4.16	1.68	2.8	17.6
	1"	FLG*	9.05	4.16	1.68	2.8	17.6
	1/2", 3/4", 1"	SW	6.30	4.16	1.68	2.8	10.0
		Butt-weld	6.30	4.16	1.68	2.8	10.0

* WPN-63: 300# FLG
WPN-100: 600# FLG
WPN-160: 900# FLG
WPN-250: 1500# FLG

The capacity charts show the maximum flow at factory setting.

- Curve 1 Maximum Flow quantity of Condensate at approximately 18 & 27°F below boiling temperature.
- Curve 2 Maximum Flow of Sub-Cooled condensate at approx. 54°F below boiling temperature (through back up of condensate).
- Curve 3 Maximum Flow quantity of Cold Condensate at about 68°F (during start-up of a cold system).

Cooler temperatures cause the seat in the controller to open wider; therefore, trap capacity will increase when colder condensate is in contact with the Bi-metal element. Trap capacity is given at different temperatures below saturated steam temperature.

WPN-63 • 1/2", 3/4", 1"

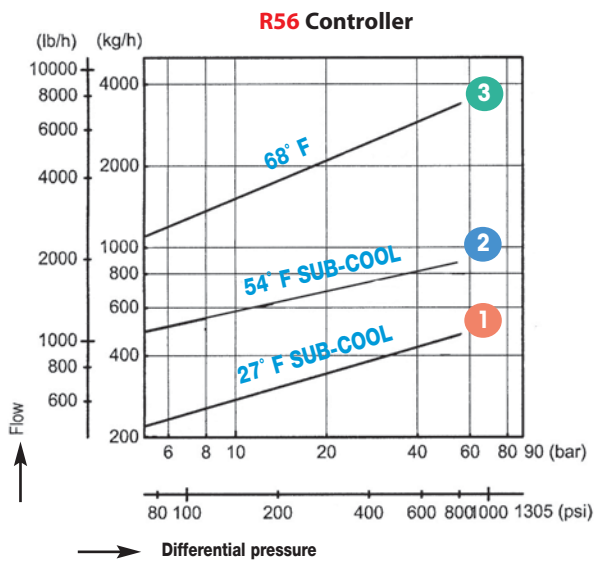

WPN-100 • 1/2", 3/4", 1"

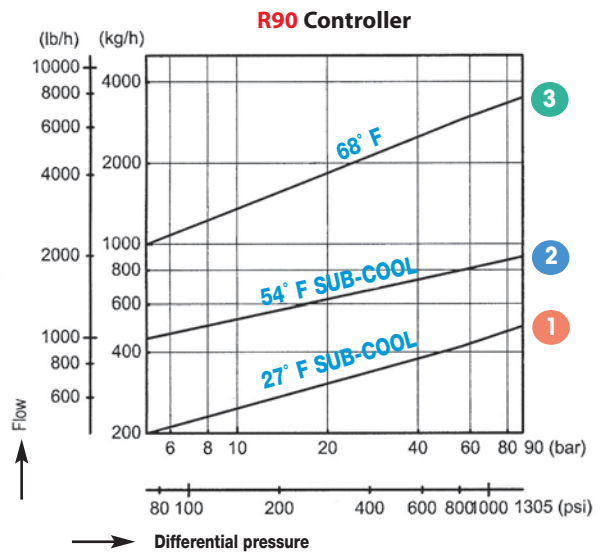

WPN-160 • 1/2", 3/4", 1"

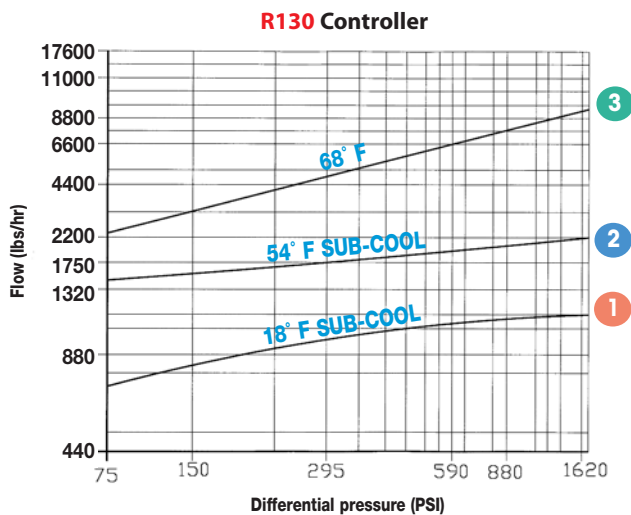

WPN-250 • 1/2", 3/4", 1"

