

Type 0283, 0293

2/2-way solenoid valve
2/2-Wege-Magnetventil
Électrovanne 2/2 voies



Operating Instructions

Bedienungsanleitung
Manuel d'utilisation

Contents

1	The operating instructions	2
2	Intended use.....	3
3	Basic Safety Instructions.....	4
4	Technical Data.....	5
5	Installation.....	7
6	Maintenance, Troubleshooting.....	9
7	Spare parts.....	10
8	Transport, Storage, Disposal.....	11

1 THE OPERATING INSTRUCTIONS

The operating instructions contain important information.

- ▶ Read the instructions carefully and follow the safety instructions in particular.
- ▶ Keep the instructions in a location where they are available to every user.
- ▶ The liability and warranty for Type 0283, 0293 are void if the operating instructions are not followed.

1.1 Symbols

- ▶ Designates instructions for risk prevention.
- Designates a procedure which you must carry out.

Warning of injuries:

 **DANGER!** Immediate danger! Serious or fatal injuries.

 **WARNING!** Possible danger! Serious or fatal injuries.

 **CAUTION!** Danger! Moderate or minor injuries.

Warning of damage:

NOTE!

2 INTENDED USE

The solenoid valve Type 0283 and Type 0293 is designed for dosing, blocking, filling and aerating media.

Type 0293 is classified in accordance with DIN EN 161 Group 2, Class B for gas.

- ▶ Use according to the permitted data, operating conditions and conditions of use specified in the contract documents and operating instructions. These are described in the chapter entitled "Technical Data".
- ▶ Provided the cable plug is connected and installed correctly, e.g. Bürkert Type 2508, the device satisfies degree of protection IP65 in accordance with DIN EN 60529 / IEC 60529.
- ▶ Do not physically stress the device (e.g. by placing objects on it, using it as a screwing aid, standing on it or using it as a lever arm).
- ▶ The device may be used only in conjunction with third-party devices and components recommended and authorised by Bürkert.
- ▶ Use device only when in perfect condition and always ensure proper storage, transportation, installation and operation.
- ▶ Use the device only as intended.

2.1 Definitions of terms

The term "device" always refers to the solenoid valve Type 0283 or Type 0293.

3 BASIC SAFETY INSTRUCTIONS

These safety instructions do not make allowance for any contingencies and events which may arise during the installation, operation and maintenance of the devices.



Danger – high pressure.

- ▶ Before loosening the lines and valves, turn off the pressure and vent the lines.

Risk of electric shock.

- ▶ Before reaching into the device, switch off the power supply and secure to prevent reactivation!
- ▶ Observe applicable accident prevention and safety regulations for electrical equipment!

Risk of burns/Risk of fire if used continuously through hot device surface.

- ▶ Keep the device away from highly flammable substances and media and do not touch with bare hands.

Risk of injury due to malfunction of valves with alternating current (AC).

Sticking core causes coil to overheat, resulting in a malfunction.

- ▶ Monitor process to ensure function is in perfect working order!

General hazardous situations.

To prevent injury, ensure that:

- ▶ The system cannot be activated unintentionally.
- ▶ Installation and repair work may be carried out by authorized technicians only and with the appropriate tools.
- ▶ After an interruption in the power supply or pneumatic supply, ensure that the process is restarted in a defined or controlled manner.
- ▶ The device may be operated only when in perfect condition and in consideration of the operating instructions.
- ▶ The general rules of technology apply to application planning and operation of the device.
- ▶ Do not make any modifications to the device. Do not paint the housing parts or screws.

4 TECHNICAL DATA

4.1 Conformity

Type 0283 and Type 0293 conforms with the EC Directives according to the EC Declaration of Conformity (if applicable).

4.2 Standards

The applied standards, which verify conformity with the EC Directives, can be found on the EC-Type Examination Certificate and / or the EC Declaration of Conformity (if applicable).

4.3 Type label (Examples)

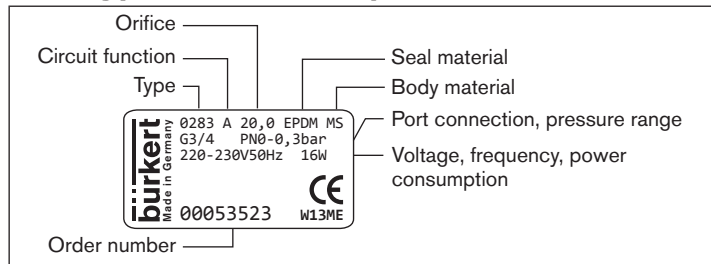

Fig. 1: Type label solenoid valve type 0283 (Example)

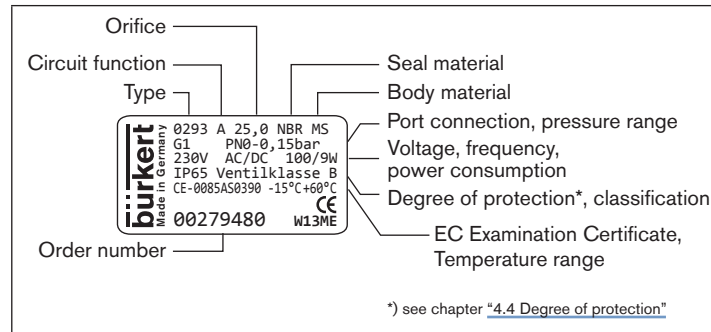



Fig. 2: Type label solenoid valve type 0293 (Example)

4.4 Degree of protection

Provided the cable plug is connected and installed correctly, e.g. Bürkert Type 2508, the device satisfies degree of protection IP65 in accordance with DIN EN 60529 / IEC 60529.

Type 0283 and type 0293: Cable plug e.g. Bürkert Type 2508

4.5 Operating conditions

 The values indicated on the rating plate must be observed during operation of the device.

Circuit function of the direct-acting 2/2-way solenoid valve:

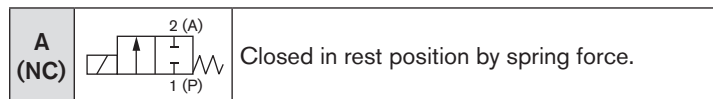

Permitted media

Type	Seal material	Permitted media
0283	NBR	Neutral media, compressed air, water, hydraulic oil
	FKM	Per solutions, hot oils
	EPDM	Oil and grease-free media, e.g. hot water
0293	NBR	Valve group 2, Class B: Fuel gases of the 1st, 2nd and 3rd gas family

Permitted medium and ambient temperature

Type	Seal material	Permitted media	Permitted ambient temperature
0283	NBR	-10...+90 °C	max. 55 °C
	FKM	0...+100 °C	
	EPDM	-30...+100 °C	
0293	NBR	-15...+80 °C	-15...+60 °C

Dirt trap

Type 0283: To ensure that the solenoid valve functions reliably, a dirt trap ($\leq 500 \mu\text{m}$) must be installed upstream of the valve inlet.

Type 0293: The necessary dirt trap is integrated into the valve.

Service life

High switching frequency and high pressures reduce the service life.

4.6 Electrical Data



Note the voltage and current type as specified on the rating plate.

Connection:	Type 0283 and type 0293: DIN EN 175301-803 Form A for cable plug Type 2508
Power supply:	see type label
Voltage tolerance:	±10 %
Switching frequency:	AC max. 150/min UC max. 15/min

5 INSTALLATION

5.1 Safety instructions



DANGER!

Risk of injury from high pressure in the system/device.

- ▶ Before working on the system or device, switch off the pressure and vent/drain lines.

Risk of injury due to electrical shock.

- ▶ Before working on the system or device, switch off the power supply and secure to prevent reactivation.
- ▶ Observe applicable accident prevention and safety regulations for electrical equipment.



WARNING!

Risk of injury from improper installation.

- ▶ Installation may be carried out by authorized technicians only and with the appropriate tools.

Risk of injury from unintentional activation of the system and an uncontrolled restart.

- ▶ Secure system from unintentional activation.

- ▶ Following installation, ensure a controlled restart.

Risk of short-circuit or escape of media through leaking screw joints.

- ▶ Ensure seals are seated correctly.
- ▶ Carefully screw together coil and device socket or valve and pipelines.

5.2 Fluid installation



Follow the safety instructions under [“5.1”](#).

Installation can be in any position, preferably actuator upright.

- Before installation, clean any possible dirt off the pipelines.
- For Type 0283 install a dirt filter ($\leq 500 \mu\text{m}$) upstream of the valve inlet (Type 0293 already has the dirt filter integrated in the valve).
- Seal the pipe connection with PTFE tape.
Attention: The PTFE tape must not get into the device.
- Observe direction of flow (see [“Fig. 3”](#)).

NOTE!

Caution risk of breakage.

- ▶ Do not use the coil as a lever arm.

→ Hold the device with an open-end wrench on the housing and screw into the pipeline.

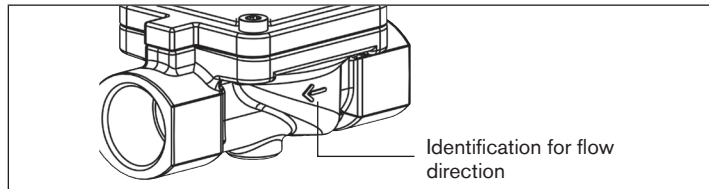

Fig. 3: Identification of flow direction

5.3 Electrical installation



WARNING!

Danger of electrical shock if the protective conductor contact between the coil and housing is missing.

- ▶ Always connect protective conductor.



Follow the safety instructions under “5.1” and observe the voltage and current type specifications on the rating plate.

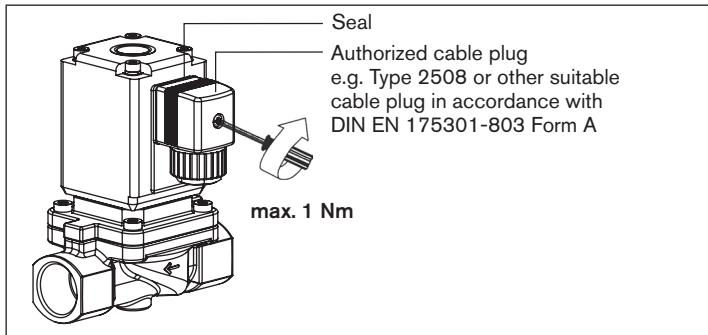

Fig. 4: Connection of the cable plug – example Type 0293

6 MAINTENANCE, TROUBLESHOOTING



DANGER!

Risk of injury from high pressure in the system/device.

- ▶ Before working on the system or device, switch off the pressure and vent/drain lines.

Risk of injury due to electrical shock.

- ▶ Before working on the system or device, switch off the power supply and secure to prevent reactivation.
- ▶ Observe applicable accident prevention and safety regulations for electrical equipment.



WARNING!

Risk of injury from improper maintenance.

- ▶ Maintenance may be carried out by authorized technicians only and with the appropriate tools!

Risk of injury from unintentional activation of the system and an uncontrolled restart.

- ▶ Secure system from unintentional activation.
- ▶ Following maintenance, ensure a controlled restart.



The solenoid valve Type 0293 is DVGW certified. Only Bürkert may carry out repairs.

Malfunctions

If malfunctions occur, check whether:

- the device has been installed according to the instructions,
- the connections are correct,
- the device is not damaged,
- all screws have been tightened,
- the voltage and pressure have been switched on,
- the pipelines are clean.

If the magnet does not pick up, ensure that:

- there is no short-circuit or coil interruption,
- the core / core area is not dirty.



If the valve still does not switch, please contact your Bürkert Service.

7 SPARE PARTS



CAUTION!

Risk of injury and/or damage by the use of incorrect parts.

Incorrect accessories and unsuitable spare parts may cause injuries and damage the device and the surrounding area.

- ▶ Use only original accessories and original spare parts from Bürkert.



The solenoid valve Type 0293 is DVGW certified. Only Bürkert may carry out repairs.

The following spare parts or spare parts sets are available for the solenoid valve Type 0283:

- Coil
- Housing
- Seal set SET 2
- Wear parts set SET 3

When placing an order, specify the spare part as well as the order number of your device (see rating plate).

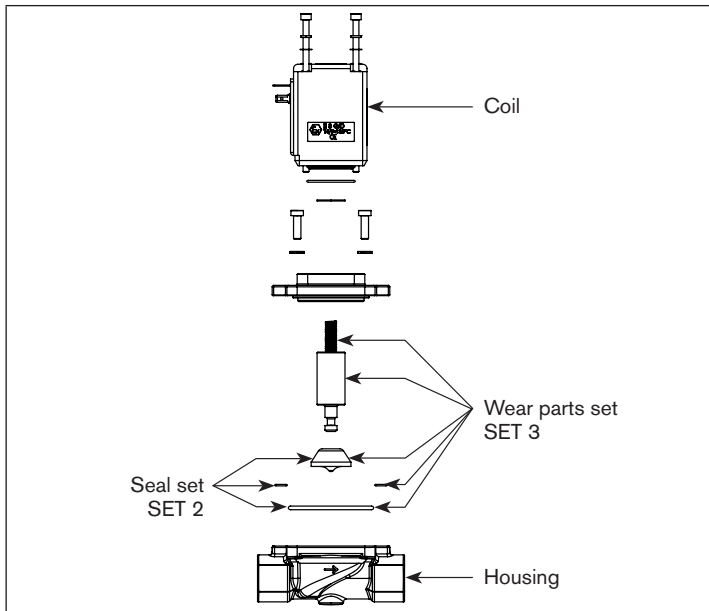

Fig. 5: Overview of replacement spare parts solenoid valve Type 0283

8 TRANSPORT, STORAGE, DISPOSAL

NOTE!

Transport damages.

Inadequately protected equipment may be damaged during transport.

- ▶ During transportation protect the device against wet and dirt in shock-resistant packaging.
- ▶ Avoid exceeding or dropping below the allowable storage temperature.

Incorrect storage may damage the device.

- ▶ Store the device in a dry and dust-free location!
- ▶ Storage temperature $-40\dots+55\text{ }^{\circ}\text{C}$.

Damage to the environment caused by device components contaminated with media.

- ▶ Observe applicable regulations on disposal and the environment.
- ▶ Dispose of the device and packaging in an environmentally friendly manner.

Bürkert Fluid Control Systems
Sales Center
Christian-Bürkert-Str. 13-17
D-74653 Ingelfingen
Tel. + 49 (0) 7940 - 10 91 111
Fax + 49 (0) 7940 - 10 91 448
E-mail: info@buerkert.com

International address

www.burkert.com

Manuals and data sheets on the Internet: www.burkert.com
Bedienungsanleitungen und Datenblätter im Internet: www.buerkert.de
Manuels d'utilisation et fiches techniques sur Internet : www.buerkert.fr

© Bürkert Werke GmbH & Co. KG, 2010 - 2017
Operating Instructions 1703/08_EU-ml_00805786 / Original DE

www.burkert.com