

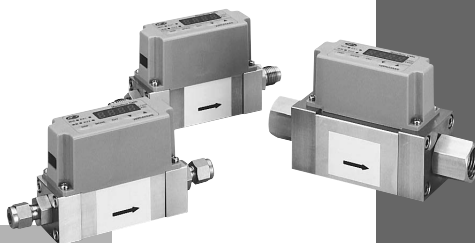

TM

CMS Series Gas Mass Flow Meter (For Hydrogen and Helium Gases) User's Manual



Thank you for purchasing the CMS Series Gas Mass Flow Meter for hydrogen and helium gases.

This manual contains information for ensuring correct use of the CMS Series. It also provides necessary information for installation, maintenance, and troubleshooting.

This manual should be read by those who design and maintain devices that use the CMS Series.

Be sure to keep this manual nearby for handy reference.

Azbil Corporation

Please read the "Terms and Conditions" from the following URL before ordering or use:

<http://www.azbil.com/products/bi/order.html>

NOTICE

Be sure that the user receives this manual before the product is used.

Copying or duplicating this user's manual in part or in whole is forbidden. The information and specifications in this manual are subject to change without notice.

Considerable effort has been made to ensure that this manual is free from inaccuracies and omissions. If you should find an error or omission, please contact Azbil Corporation.

In no event is Azbil Corporation liable to anyone for any indirect, special or consequential damages as a result of using this product.

© 2005-2012 Azbil Corporation All Rights Reserved.

The µF logo, Micro Flow are trademarks of Azbil Corporation in Japan.

SAFETY PRECAUTIONS

■ About Icons

The safety precautions described in this manual are indicated by various icons. Please be sure you read and understand the icons and their meanings described below before reading the rest of the manual.

Safety precautions are intended to ensure the safe and correct use of this product, to prevent injury to the operator and others, and to prevent damage to property. Be sure to observe these safety precautions.



WARNING

Warnings are indicated when mishandling this product might result in death or serious injury.



CAUTION

Cautions are indicated when mishandling this product might result in minor injury to the user, or only physical damage to the product.

■ Examples

| | |
|--|---|
| | Use caution when handling the product. |
| | The indicated action is prohibited. |
| | Be sure to follow the indicated instructions. |

WARNING



Never allow gases that are within explosive limits (in particular, mixed gases within explosive limits that contain hydrogen) to pass through this meter or device.
Doing so might result in explosion accidents.



When using this device for gases that contain hydrogen, be sure to purge the device with an inert gas (nitrogen, argon, etc.) before use. Use without purging the device with an inert gas might cause an explosion and accident. Turn off power before purge, failure to do so might result in the indication of "Err1".

CAUTION



Be sure to use this product within the flowrate range stated in the specifications. To prevent excessive flow, use a suitable means to control the supply pressure or use a throttle valve or the like to control the flowrate. If the flowrate exceeds the upper limit, both the flowrate display and the output voltage/current may indicate considerably lower values than the actual flowrate.



If damage could result from the abnormal functioning of this device, include appropriate redundancy in the system design.



Prevent foreign matter from entering the device.
If the rust, water droplet, oil mist or dust in the piping flows into the device, measurement error might occur and result in damaging the device.
If there is a possibility that any foreign matter flows into the device, provide a filter, strainer or mist trap capable of eliminating more than 1 μ m foreign matter at the upstream, and periodically inspect and replace the filter.















This device is exclusively for hydrogen and helium gases. It cannot be used for measurement of gases other than hydrogen and helium, and mixtures of these gases (excluding mixtures within explosive limits). Oxygen cannot be measured even if gas-contacting sections on this device are oil-inhibited.
This device is set initially for hydrogen gas use before shipment from the factory. When using it for helium gas or mixed gases, the user must change the gas type setting.
Use of this device for helium gas or mixed gases without changing the gas type setting might result in an error.



Do not use this device outside of the operating pressure range. Also, do not subject this device to a pressure above the pressure resistance. Doing so might damage this device.

CAUTION

| | | | | | | | | | |
|---|--|---------------------------------|------------------|---------------------------------|------------------|----------------------------|----------------------|----------------------------|---|
|  | <p>When connecting piping, fasten the hexagonal section of the joint, and turn the pipe side to connect. After connecting the piping, check for any gas leaks.</p> | | | | | | | | |
|  | <p>Before connecting pipes on Swagelok connection method and VCR connection method, check the precautions in the instruction manual provided by the connecting joint manufacturer. When purchasing a separate connecting joint, use the following made by corresponding connection joint maker.</p> <table><tr><td>1/4Swagelok : Swagelok Co.,Ltd.</td><td>SS-400-1-6STSC11</td></tr><tr><td>1/2Swagelok : Swagelok Co.,Ltd.</td><td>SS-810-1-8STSC11</td></tr><tr><td>1/4VCR : Swagelok Co.,Ltd.</td><td>SS-4-VCR-1-00032SC11</td></tr><tr><td>3/8VCR : Swagelok Co.,Ltd.</td><td>SS-8-VCR-1-8STSC11 or equivalent product.</td></tr></table> | 1/4Swagelok : Swagelok Co.,Ltd. | SS-400-1-6STSC11 | 1/2Swagelok : Swagelok Co.,Ltd. | SS-810-1-8STSC11 | 1/4VCR : Swagelok Co.,Ltd. | SS-4-VCR-1-00032SC11 | 3/8VCR : Swagelok Co.,Ltd. | SS-8-VCR-1-8STSC11 or equivalent product. |
| 1/4Swagelok : Swagelok Co.,Ltd. | SS-400-1-6STSC11 | | | | | | | | |
| 1/2Swagelok : Swagelok Co.,Ltd. | SS-810-1-8STSC11 | | | | | | | | |
| 1/4VCR : Swagelok Co.,Ltd. | SS-4-VCR-1-00032SC11 | | | | | | | | |
| 3/8VCR : Swagelok Co.,Ltd. | SS-8-VCR-1-8STSC11 or equivalent product. | | | | | | | | |
|  | <p>In the case of 1/2Rc, 1/4Rc connections, take care not to coat with too much sealant. Dirt or burrs in the piping may also cause errors.</p> | | | | | | | | |
|  | <p>This device is a precision instrument. Do not drop it nor subject it to shock. Doing so might damage the device.</p> | | | | | | | | |
|  | <p>When using a relay as the contact for integrated count reset input, use a relay (gold contact type) for trace currents. Otherwise, defective contact may cause the device to malfunction.</p> | | | | | | | | |
|  | <p>Be sure to check that the wiring is correct before turning the power ON. Incorrect wiring might cause damage or malfunction.</p> | | | | | | | | |
|  | <p>If there is a risk of a power surge caused by lightning, use Azbil Corporation's SurgeNon to prevent possible fire or equipment failure.</p> | | | | | | | | |
|  | <p>When mounting the device, firmly fasten to prevent vibration.</p> | | | | | | | | |
|  | <p>Mount this device horizontally. If this device is mounted vertically, drift will occur when flowrate is zero.</p> | | | | | | | | |
|  | <p>Do not mount so that the display is facing down. Doing so might cause error or trouble.</p> | | | | | | | | |
|  | <p>Do not operate the keys with a mechanical pencil or sharp-tipped object. Doing so might cause faulty operation.</p> | | | | | | | | |
|  | <p>Do not hold a resin cover portion at the time of carrying or piping this device. Doing so might damage the cover, or dropping the device due to slipping might result in getting hurt.</p> | | | | | | | | |
|  | <p>Make sure that the selected analog output type matches the input type of the receiving device. The output-receiving device could be damaged if the analog output type selection is incorrect.</p> | | | | | | | | |

Contents

SAFETY PRECAUTIONS
Conventions Used in This Manual

Chapter 1. INTRODUCTION

- Introduction..... 1
- Features 1
- Model selection guide..... 2

Chapter 2. NAMES AND FUNCTIONS OF PARTS

Chapter 3. MOUNTING AND WIRING

- Mounting 5
- Behavior when the flowrate greatly exceeds
the upper limit of flowrate range 6
- Piping 6
- Wiring 11

Chapter 4. METHOD OF OPERATION

- State transition diagram..... 14
- Function setup..... 15
- Parameter setup 18
- Display off mode..... 20
- About integration and reverse-integration..... 21
- Resetting the integrated value and reverse-integrated value 21
- What is "Event standby?" 21
- Event ON delay 21
- Flowrate zero calibration 22

Chapter 5. TROUBLESHOOTING

- Remedying trouble 23

Chapter 6. SPECIFICATIONS

- General specifications..... 24
- External dimensions..... 28
- Pressure loss..... 33

Conventions Used in This Manual

The following conventions are used in this manual:



Handling Precautions

: Handling Precautions indicate items that the user should pay attention to when handling the **CMS Series**.



Note

: Notes indicate useful information that the user might benefit by knowing.

(1), (2), (3)

: The numbers with the parenthesis indicate steps in a sequence or indicate corresponding parts in an explanation.

03, P-07

: This indicates 7-segment indication on the setup display.



key

: This indicates a key on the setup display.

Chapter 1. INTRODUCTION

■ Introduction

The CMS Series Gas mass flow meter uses μF (Micro Flow) sensor in the sensing section. The μF sensor is a thermal flow speed sensor made using proprietary technology. Integrating this ultra-minute flow speed sensor with high-grade channel design technology has achieved high accuracy and high rangeability.

■ Features

- Incorporates a μF sensor made possible by silicon micro-machining technology and thin-film forming technology.
One side of the μF sensor is a mere 1.7mm, and at a thickness of 0.5mm, this thermal flow speed sensor exhibits high sensitivity and response.
- As the CMS Series are mass flow meter, it is not influenced by temperature nor pressure.
- High accuracy of $\pm 5\%RD^*$ and high resolution
0.01L/min (standard) (CMS0010)
0.1L/min (standard) (CMS0050)
1L/min (standard) (CMS0200/0500/1000)
5L/min (standard) (CMS2000)
- The CMS Series are provided with extensive functions to suit a wide range of applications: analog output, event output, integrating/reverse-integrating display, output scaling, gas type selection, integrated pulse output, external contact input (integrating reset input) and flowrate data serial output.
- Straight pipe sections are not required before and after this device.

Note

* "RD" (Reading) indicates the accuracy of the read value.

Model selection guide

The following shows the model Nos. for this flow meter:

| Basic model No. | Flowrate range | Model type | Material | Connection method | Gas type | Output | Optional function | | | | Appended No. | Description | |
|-----------------|----------------|------------|----------|-------------------|----------|--------|-------------------|---|---|---|--------------|--|-----------------|
| | | | | | | | 1 | 2 | 3 | 4 | | | |
| CMS | 0010 | | | | | | | | | | | Gas Mass Flow Meter | |
| | 0050 | | | | | | | | | | | Standard flowrate range 0 to 10L/min (standard) *1 | |
| | 0200 | | | | | | | | | | | Standard flowrate range 0 to 50L/min (standard) *1 | |
| | 0500 | | | | | | | | | | | Standard flowrate range 0 to 200L/min (standard) *1 | |
| | 1000 | | | | | | | | | | | Standard flowrate range 0 to 500L/min (standard) *1 | |
| | 2000 | | | | | | | | | | | Standard flowrate range 0 to 1000L/min (standard) *1 | |
| | | B | | | | | | | | | | Standard flowrate range 0 to 2000L/min (standard) *1 | |
| | | | | | | | | | | | | Model with display | |
| | | | T | | | | | | | | | SUS316 | |
| | | | | U | | | | | | | | 9/16-18UNF(CMS0010/0050/0200) | |
| | | | | | T | | | | | | | 3/4-16UNF(CMS0500/1000/2000) | |
| | | | | | | | | | | | | Rc1/4(CMS0010/0050/0200) | |
| | | | | | | | | | | | | Rc1/2(CMS0500/1000/2000) | |
| | | | | | S | | | | | | | 1/4Swagelok(CMS0010/0050/0200) | |
| | | | | | | | | | | | | 1/2Swagelok(CMS0500/1000/2000) | |
| | | | | | | | | | | | | 1/4VCR(CMS0010/0050/0200) | |
| | | | | | | | | | | | | 3/8VCR or equivalent product(CMS0500/1000/2000) | |
| | | | | | | H | | | | | | Hydrogen, Helium *2 | |
| | | | | | | | 2 | | | | | Analog output 0 to 5Vdc / 1 to 5 Vdc / 4 to 20mAdc | |
| | | | | | | | | 0 | | | | Without optional function | |
| | | | | | | | | | 1 | | | With RS-485 communications | |
| | | | | | | | | | | 0 | | Without optional function | |
| | | | | | | | | | | | 1 | Gas-contacting parts treated to be oil-inhibiting | |
| | | | | | | | | | | | 0 | Without options | |
| | | | | | | | | | | | D | Inspection Certificate provided | |
| | | | | | | | | | | | Y | Complying with the traceability certification | |
| | | | | | | | | | | | | 0 | Product version |

*1 L/min (standard) indicates the volume flowrate (L/min) per minute converted to 20°C, one atmosphere.

*2 The gas type is initially set for hydrogen use. However, the user can change this setting for helium use.

Optical parts (sold separately)

| Name | Parts No. | Remarks |
|---|--------------|--|
| Harness with connector exclusive to CMS (One harness is required for one CMS unit) | 81446594-005 | Harness (2m) for model without communications – plain wire termination |
| | 81446594-006 | Harness (5m) for model without communications – plain wire termination |
| | 81446594-007 | Harness (2m) for model with communications -- M3.5 Y-terminals |
| | 81446594-008 | Harness (5m) for model with communications -- M3.5 Y-terminals |
| Mounting bracket | 81446628-001 | For CMS0010/0050/0200 |
| | 81446721-001 | For CMS0500/1000 |
| | 81446856-001 | For CMS2000 |
| AC/DC adaptor | 81446957-001 | Operating temperature range 0 to 40°C |
| Harness for AC/DC adaptor | 81446594-030 | This harness is necessary for AC/DC adaptor. |

Spare parts

| Name | Parts No. | Remarks |
|-------|--------------|--------------------------|
| Joint | 81446834-001 | Rc 1/4, a set of 2. |
| | 81446834-002 | Rc 1/2, a set of 2. |
| | 81446833-001 | 1/4Swagelok, a set of 2. |
| | 81446833-002 | 1/2Swagelok, a set of 2. |
| | 81446895-001 | 1/4VCR, a set of 2. |
| | 81446895-002 | 3/8VCR, a set of 2. |

Chapter 2. NAMES AND FUNCTIONS OF PARTS

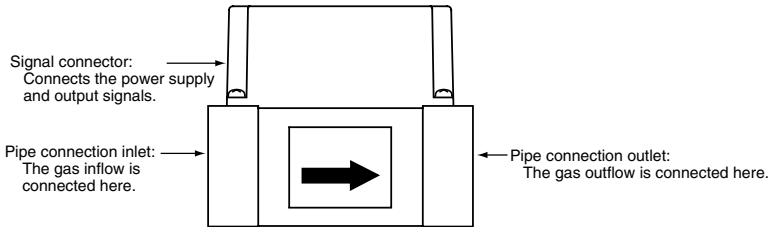
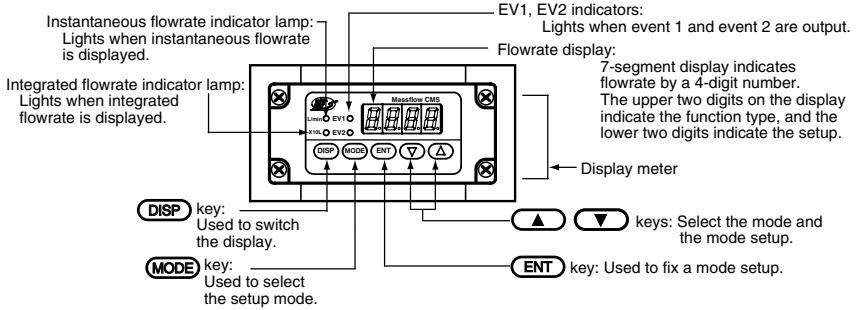

The following describes the names and functions of parts:

The diagram below shows CMS0500 model.











Chapter 3. MOUNTING AND WIRING

WARNING

-  Never allow gases that are within explosive limits (in particular, mixed gases within explosive limits that contain hydrogen) to pass through this meter or device.
Doing so might result in explosion accidents.
-  When using this device for gases that contain hydrogen, be sure to purge the device with an inert gas (nitrogen, argon, etc.) before use.
Use without purging the device with an inert gas might cause an explosion and accident. Turn off power before purge, failure to do so might result in the indication of "Err1".

CAUTION

-  Be sure to use this product within the flowrate range stated in the specifications. To prevent excessive flow, use a suitable means to control the supply pressure or use a throttle valve or the like to control the flowrate. If the flowrate exceeds the upper limit, both the flowrate display and the output voltage/current may indicate considerably lower values than the actual flowrate.
-  If damage could result from the abnormal functioning of this device, include appropriate redundancy in the system design.
-  Prevent foreign matter from entering the device.
If the rust, water droplet, oil mist or dust in the piping flows into the device, measurement error might occur and result in damaging the device.
If there is a possibility that any foreign matter flows into the device, provide a filter, strainer or mist trap capable of eliminating more than 1 μ m foreign matter at the upstream, and periodically inspect and replace the filter.
-  This device is exclusively for hydrogen and helium gases. It cannot be used for control and measurement of gases other than hydrogen and helium, and mixtures of these gases (excluding mixtures within explosive limits).
Oxygen cannot be measured even if gas-contacting sections on this device are oil-inhibited.
This device is set initially for hydrogen gas use before shipment from the factory. When using it for helium gas or mixed gases, the user must change the gas type setting.
Use of this device for helium gas or mixed gases without changing the gas type setting might result in an error.
-  Do not use this device outside of the operating pressure range. Also, do not subject this device to a pressure above the pressure resistance.
Doing so might damage this device.
-  When connecting piping, fasten the hexagonal section of the joint, and turn the pipe side to connect.
After connecting the piping, check for any gas leaks.
-  When mounting the device, firmly fasten to prevent vibration.
-  In the case of 1/2Rc, 1/4Rc connections, take care not to coat with too much sealant. Dirt or burrs in the piping may also cause errors.

 **CAUTION**

Before connecting pipes on Swagelok connection method and VCR connection method, check the precautions in the instruction manual provided by the connecting joint manufacturer.

When purchasing a separate connecting joint, use the following made by corresponding connection joint maker.

1/4Swagelok : Swagelok Co.,Ltd. SS-400-1-6STSC11

1/2Swagelok : Swagelok Co.,Ltd. SS-810-1-8STSC11

1/4VCR : Swagelok Co.,Ltd. SS-4-VCR-1-00032SC11

3/8VCR : Swagelok Co.,Ltd. SS-8-VCR-1-8STSC11 or equivalent product



This device is a precision instrument. Do not drop it nor subject it to shock. Doing so might damage the device.



Do not hold a resin cover portion at the time of carrying or piping this device.

Doing so might damage the cover, or dropping the device due to slipping might result in getting hurt.

■ Mounting

● Installation site

Avoid mounting the CMS Series in the following locations:

- Locations whose operating temperature falls below -10°C and rises above 60°C
- Locations whose operating humidity exceeds 90%RH
- Locations subject to sudden changes in temperature and condensation
- Locations subject to corrosive gases and flammable gases
- Locations where there are lots of conductive substances (e.g. dust, salt or iron dust), water droplets, oil mist or organic solvents
- Locations subject to vibration or shock
- Locations subject to direct sunlight
- Locations splashed by water or rain
- Locations subject to splashing by fluids (e.g. oil, chemicals.)
- Locations where strong magnetic or electrical fields are generated

■ Behavior when the flowrate greatly exceeds the upper limit of flowrate range

When the flowrate exceeds the upper limit of flowrate range, both the flowrate display and the output voltage/current may indicate lower values than the actual flowrate. Be sure to use this product within the flowrate range stated in the specifications.

If the actual flowrate exceeds 120 % of the upper limit, both the flowrate display and the output voltage/current will stop increasing in proportion to the flowrate. If the flowrate is more than 200 % of the upper limit, both the flowrate display and the output voltage/current will begin to decrease, giving the appearance that the flowrate is within the flowrate range limits.

Also, if there is a sudden greatly excessive flowrate (200% of the upper limit or more) for a very short period, the flowrate display and the output voltage/current will continue to indicate flow within the flowrate range, without indicating the spike.

Especially when this device is used for flow control, make sure to take appropriate measures, such as controlling the supply pressure or using a throttle valve, so that even at maximum control output, the flowrate does not exceed 120% of the upper limit.

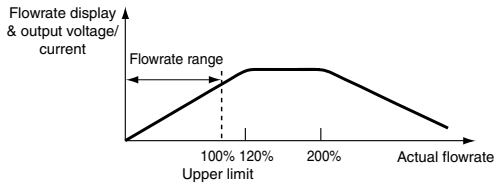

■ Piping

● Precautions for piping installation

This device is a precision instrument. If foreign matter such as dust, oil mist or water enters the device, it may cause measurement error or faulty operation. When installing piping, be sure to follow the procedures below to prevent foreign matter from entering the device.

- (1) Before installing the device, be sure to flush the upstream and downstream piping thoroughly to remove welding fume particulate and dust.
- (2) Be sure to wipe the inside of the pipe to be directly connected to this device.
- (3) After the above two operations are complete, check to be sure that there is no welding fume particulate or dust, and then install the device.

1 Handling Precautions

- If foreign matter cannot be fully eliminated by flushing or wiping, or if the regular presence of foreign matter can be expected, be sure to install a filter. If dust, oil or moisture adheres to the metallic mesh or to the Micro Flow sensor chip, measurement error or device failure may result.

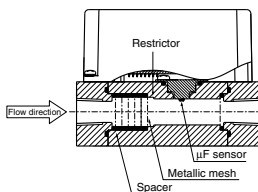

● **Straight pipe section**

In case of a different diameter pipe (A diameter is different from B diameter.), straight pipe section may be required.

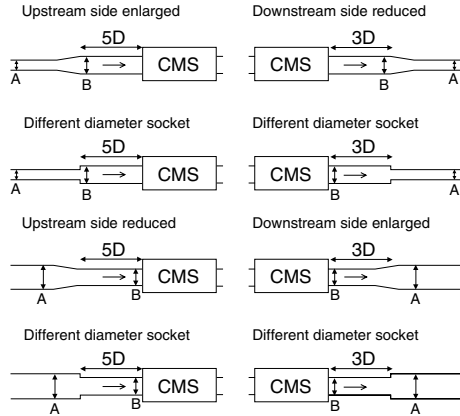

D indicates the connecting port size.
 CMS0500/1000/2000: 12mm
 CMS0010/0050/0200: 6mm

In case of a same diameter pipe (A and B diameters are same.), straight pipe section may not be required.

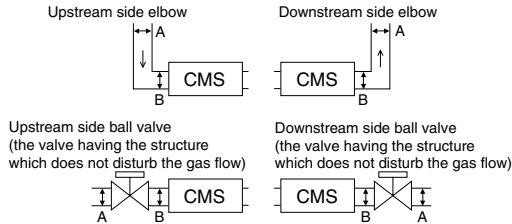

1 **Handling Precautions**

Provide the 5D straight pipe section between the CMS and the butterfly valve or the like in case of a valve having the structure which causes disturbance or fluctuations to the gas flow.

● Rc Joint

• Coating sealant

Coat with an appropriate amount of sealant. Do not coat the top two threads of the screw. Remove any dirt or burrs from inside the pipes.

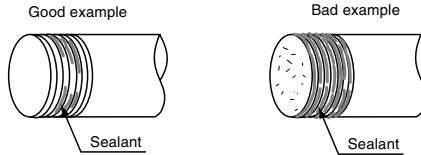

• Connecting Pipes

Connect pipes while gripping the Rc joint section of the pipe connection port with a spanner or wrench.

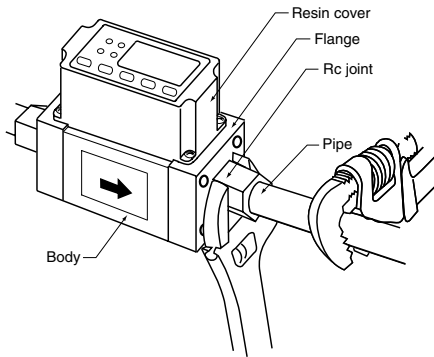

❗ Handling Precautions

- Do not grip and turn the body. Doing so might damage the body or cause leakage.
- When connecting pipes, do not grasp the resin cover. Doing so might damage the cover.

• Gas flow

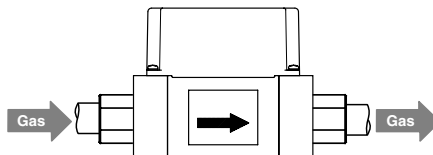

❗ Handling Precautions

When feeding gas into the meter, make it flow following the arrow on the side of the channel. If gas is fed in the opposite direction, the gas flow cannot be measured accurately.

● UNF Joint

• Connecting joint

Connect joint while gripping the flange section of the pipe connection port with a spanner or wrench.

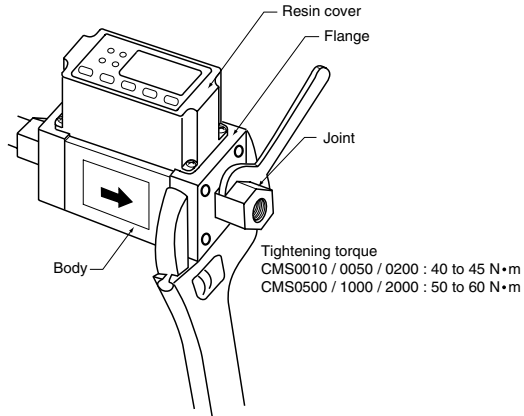

❗ Handling Precautions

- Do not grip and turn the body. Doing so might damage the body or cause leakage.
- When connecting pipes, do not grasp the resin cover. Doing so might damage the cover.
- Keep the specified tightening torque.

• Gas flow

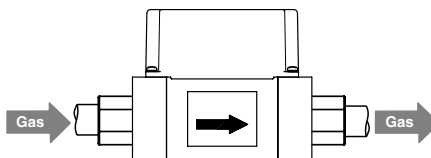

❗ Handling Precautions

When feeding gas into the meter, make it flow following the arrow on the side of the channel. If gas is fed in the opposite direction, the gas flow cannot be measured accurately.

● Mounting the body

! CAUTION



Mount this device horizontally. When this device is mounted vertically, drift will occur when flowrate is zero.



Do not mount so that the display is facing down. Doing so might cause error or trouble.

There are two ways of mounting the body of the CMS0010 / 0050 / 0200 / 0500 / 1000 / 2000:

- (1) Fasten the body with the following screws from the rear side using the mounting screws on the bottom of the device :
- CMS0010/0050/0200: two screws
 - CMS0500/1000/2000: four screws

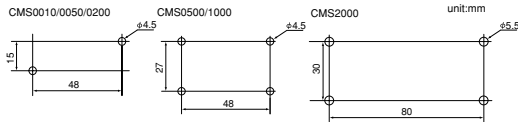

- (2) Attach the mounting bracket, and fasten the mounting bracket from the front using four screws. Bracket part No. as follows:

- CMS0010/0050/0200: 81446628-001
- CMS0500/1000: 81446721-001
- CMS2000: 81446856-001

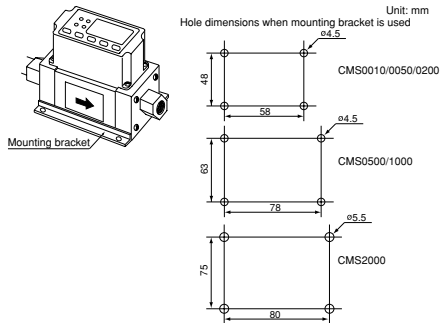

Mounting Position

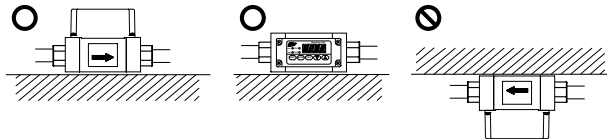

! Handling Precautions

In case of vertical mounting, drift will occur when flowrate is zero. For details, please contact the azbil Group.

■ Wiring

| |
|---|
| ⚠ CAUTION |
| <p>! When using a relay as the contact for integrated count reset input, use a relay (gold contact type) for trace currents. Otherwise, defective contact may cause the device to malfunction.</p> <p>! If there is a risk of a power surge caused by lightning, use Azbil Corporation's SurgeNon to prevent possible fire or equipment failure.</p> <p>! Be sure to check that the wiring is correct before turning the power ON. Incorrect wiring might cause damage or malfunction.</p> |

We recommend using the harness (sold separately) with connector exclusive to CMS.

● Connector pin layout

The following shows the layout of the connector pins on this flow meter:

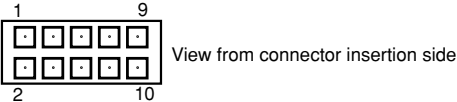

Compatible connector:
 DF11-10DS-2C made by HIROSE ELECTRIC CO., LTD.
 Harness with connector exclusive to CMS:
 See optional parts (page 2)

● Connector signal table

| Pin number | Signal name | Description | Remarks |
|------------|-------------|--|---|
| 1 | DC OUT+ | Instantaneous flowrate output + | |
| 2 | DC OUT- | Instantaneous flowrate output - | |
| 3 | V + | Power + (12 to 24Vdc) | |
| 4 | GND | Power GND | |
| 5 | DA | For RS-485 communications | Do not connect for the model without RS-485 communications. |
| 6 | DB | | |
| 7 | DI | Integration count reset input | |
| 8 | EV2 | Event 2 output/Integration pulse output | |
| 9 | EV1 | Event 1 output/Serial data output | |
| 10 | EVCOM/SG | Event output common / RS-485 communications common | |

Connection example

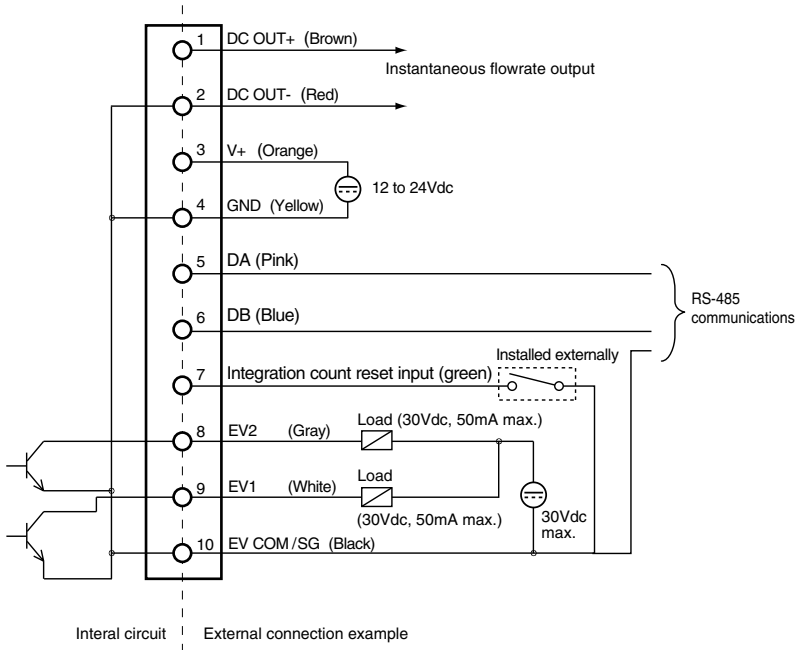

1 Handling Precautions

- Power source GND, instantaneous flow rate output (-), and event output common lines are all connected inside this device. If these lines are connected to an external device through a common power supply, interference will cause device failure or faulty operation.
- Take care that the event output does not exceed the output rating of this device. If a relay is used, the coil should have a built-in surge absorption diode. Otherwise device failure could occur.

● Connection of totalizer pulse output to a counter

- Non-voltage input type

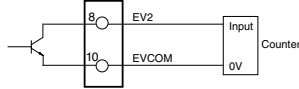

- Voltage input type

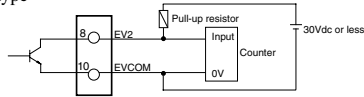

● When using flowrate data serial output

- Connection example

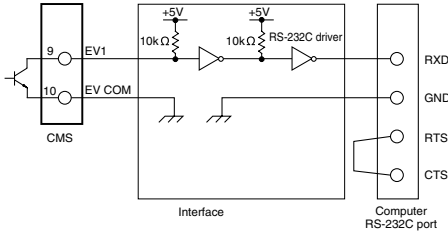

- Communications protocol

Currently displayed instantaneous flowrate data and integrated flowrate data is sent as ASCII code. Data is sent in order instantaneous flowrate data followed by integrated flowrate data. Instantaneous flowrate data is prefixed with "F" and integrated flowrate data is prefixed with "T".

Example: When instantaneous flowrate is 10.0L/min (standard), and integrated flowrate is 100L.

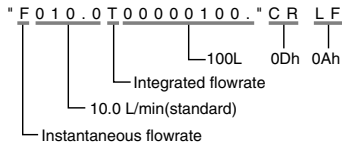

- Communications specifications

| Item | Description |
|-------------------------|---|
| Communications method | Conform to RS-232C, Start-stop transmission |
| Transmission speed | 9600bps |
| Character length | 8bits |
| Stop bit | 2bit |
| Parity | None |
| Data transmission cycle | 100±10ms |

Chapter 4. METHOD OF OPERATION

⚠ CAUTION



Do not operate the keys with a mechanical pencil or sharp-tipped object. Doing so might cause faulty operation.



Make sure that the selected analog output type matches the input type of the receiving device. The output-receiving device could be damaged if the analog output type selection is incorrect.

■ State transition diagram

In the factory setting, the instantaneous flowrate indicator lamp lights.

The following diagram shows the relationship between migration modes and display:

If 0201 or 0202 are set in the display mode setup, the integrated flowrate or reverse-integrated flowrate is displayed by pressing the **DISP** key while the instantaneous flowrate is displayed.

Pressing the **DISP** key again returns the display to the instantaneous flowrate display.

When the power has been turned OFF then back ON again, the display state before the power was turned OFF is held.

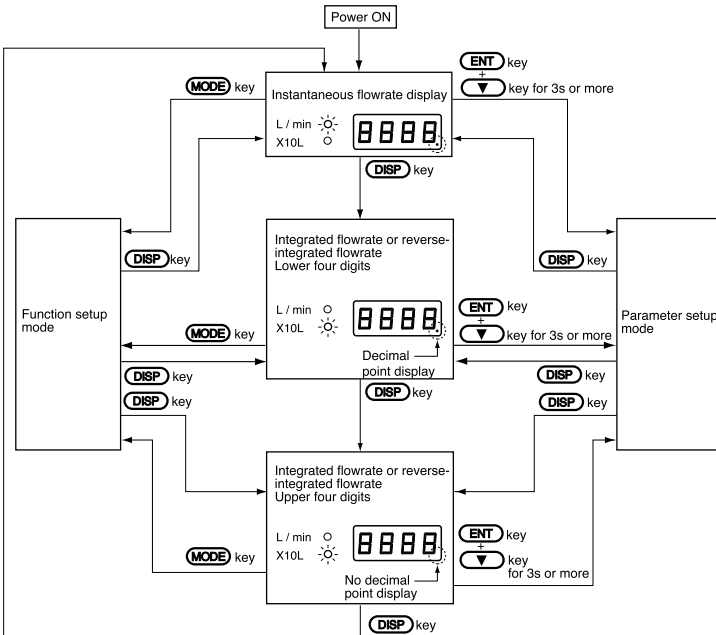

⚠ Handling Precautions

- Leave the device powered up for about 30 minutes before use to allow it to stabilize.

■ **Function setup**

The following describes how to set up each of the functions.

- To enter the setup mode, press the **(MODE)** key.
The upper two digits on the display blink. The upper two digits on the display indicate the function type, and the lower two digits indicate the setup.
- Pressing the **(▼)** key moves the setup to the next item. Pressing the **(▲)** key moves the setup item to the previous item.

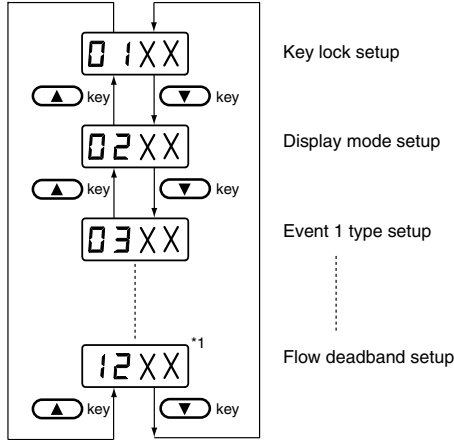

- Pressing the **(▼)** key again when $i2^{*2}$ is displayed returns the display to $0i$. Pressing the **(▲)** key again when $0i$ is displayed changes the display to $i2^{*2}$.
- When the upper two digits are the setup item that you want to set, press the **(ENT)** key while it is blinking.
This selects the setup item, and the lower two digits blink.
- Press the **(▲)** and **(▼)** keys to select the desired setting value, and press the **(ENT)** key.
All four digits light.
- Make sure that the items and the setups are correct.
- To continue setup, press the **(MODE)** key again and repeat the setup operation.

*1 : In case of the model with RS-485 communications, 30 , 31 and 32 is displayed after $i2$.

*2 : 32 is displayed for the model with RS-485 communications.

The following table shows the function and the setup:

● Function setup menu

| Mode | Function | Setting | Description | factory setting | Remarks |
|------|---|--|---|-----------------|---|
| 01 | Key lock | 00 01 | Key lock disabled Lock ON | 00 | Other modes cannot be entered in a key lock state. |
| 02 | Display mode | 00 01 02 | Only instantaneous flowrate displayed Instantaneous flowrate/integrated flowrate displayed Instantaneous flowrate/reverse integrated flowrate displayed | 01 | |
| 03 | Event 1 type (EV1) | 00 01 02 03 04 05 06 | Not used Instantaneous flowrate upper limit value Instantaneous flowrate lower limit value Integrated flowrate count up Reverse integrated flowrate count down Flowrate data serial output Error output | 00 | The operation of integrating count up, reverse-integrating count down and integration pulse output is effective only when mode 02 is set to 01 or 02. Also, integrating count up and reverse-integrating count down cannot be set simultaneously. |
| 04 | Event 2 type (EV2) | 00 01 02 03 04 05 06 07 | Not used Instantaneous flowrate upper limit value Instantaneous flowrate lower limit value Integrated flowrate count up Reverse integrated flowrate count down Integration pulse output rate*1 Integration pulse output rate*1 Integration pulse output rate*1 | 00 | |
| 05 | ON delay setting (EV1) | 00 01 | Not used Used | 00 | Displayed only when mode 03 is set to 01 or 02. |
| 06 | ON delay setting (EV2) | 00 01 | Not used Used | 00 | Displayed only when mode 04 is set to 01 or 02. |
| 07 | Event standby setting | 00 01 | Not used Used | 00 | Displayed only when mode 03 or 04 is set to 02. For more detail, see page 26. |
| 08 | Gas type selection | 08 09 10 | Conversion factor(CF) for each gas type set by the user Hydrogen Helium | 09 | When 08 is selected, set the conversion factor (CF) in the parameter setup mode. |
| 09 | Analog output scaling | 00 to 04 | *2 | 00 | *3 |
| 10 | Analog output type | 00 01 02 | 0-5 Vdc 1-5 Vdc 4-20 mA dc | 00 | |
| 11 | Flowrate conversion reference temperature | 00 to 35 | 0-35°C (1°C step) | 20 | 101.325 kPa (atmospheric pressure) reference |
| 12 | Flow deadband setting | 00 01 02 03 04 | No deadband Less than minimum display* Less than 1%FS Less than 2.5%FS Less than 5%FS | 01 | When gas type 08 is selected, setting value x CF become the deadband. CF refers to the compensation coefficient according to gas type, and its range is 0.10 to 8.00. * The minimum display differs from models. For more detail, see page 26. |

| Item | Function | Setting | Setting description | Factory setting | Remarks |
|------|------------------------|-------------------|---|-----------------|--|
| 30 | Communications address | 00 01 to 99 | Communication function disabled Communication address | 00 | For the model with RS-485 communication only |
| 31 | Transmission speed | 00 01 02 | 9600bps 4800bps 2400bps | 00 | For the model with RS-485 communication only |
| 32 | Data format | 00 01 | 8 data bits, even parity, 1 stop bit 8 data bits, no parity, 2 stop bits | 00 | For the model with RS-485 communication only |

*1 Integration pulse output rate

| mode | Setting | CMS0010/0050 | CMS0200/0500/1000/2000 |
|------|---------|--------------|------------------------|
| 04 | 05 | 1L/pulse | 10L/pulse |
| | 06 | 10L/pulse | 100L/pulse |
| | 07 | 100L/pulse | 1000L/pulse |

*2 Analog output scaling

Unit: L/min

| mode | setting | CMS0010 | CMS0050 | CMS0200 | CMS0500 | CMS1000 | CMS2000 |
|------|---------|------------------|------------------|------------------|------------------|------------------|------------------|
| 03 | 00 | 0 to 10 | 0 to 50 | 0 to 200 | 0 to 500 | 0 to 1000 | 0 to 2000 |
| | 01 | 0 to 5 | 0 to 30 | 0 to 100 | 0 to 300 | 0 to 500 | 0 to 1000 |
| | 02 | 0 to 2.5 | 0 to 20 | 0 to 50 | 0 to 200 | 0 to 250 | 0 to 500 |
| | 03 | 0 to 1 | 0 to 10 | 0 to 20 | 0 to 100 | 0 to 100 | 0 to 200 |
| | 04 | flexible scaling | flexible scaling | flexible scaling | flexible scaling | flexible scaling | flexible scaling |

*3 When 03 is selected at the gas type, the scaling becomes the value multiplied by the conversion factor of each scaling.

For example, when the scaling is set to 01: 0 to 5(L/min) on the CMS0010, and the conversion factor is 0.5, the analog output scaling becomes 0 to 2.5(L/min).

■ Parameter setup

Cancel the function setup key lock setting (key lock disabled).

Set the setting value of function setup modes 03 and 04 to other than 00.

To enter the parameter setup mode, hold down the **ENT** and **▼** keys simultaneously for at least three seconds.

In the parameter setup mode, P-__ is displayed on the display. The lower two digits on flowrate display indicate the parameter item.

Pressing the **▼** key moves the setup to the next item. Pressing the **▲** key moves the setup item to the previous item.

Press the **ENT** key at the item you want to set.

The current setting value is displayed.

If you press the **ENT** key again, the lowermost digit blinks.



If you press the **MODE** key, the blinking cursor moves to the left. To change the setting value at each of these digits, use the **▲** and **▼** keys.

Press the **ENT** key, the setting value is fixed.

When 03 or 04 has been set as the event type in the function setup, setup the 8-digit display at P-01, 02 and 07.

To do this, switch between the upper 4-digit and lower 4-digit display as follows:

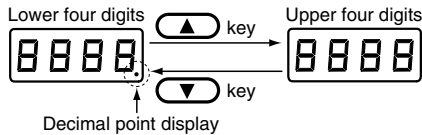

The following table shows available parameters and setting values:

P-01 to P-9 is displayed according to the setting values of the function setup.

● CMS0010

| Parameter | Item | Factory setting | Setting range | The conditions of display (Setting mode of function) |
|-----------|-----------------------------|-----------------|-------------------------|--|
| P-01 | Event 1 setting value (EV1) | 0.00 | 0.00 to 99.99(L/min) | when 03 is 01 or 02 |
| | | 00000000 | 00000000 to 99999999(L) | when 03 is 03 or 04 |
| P-02 | Event 2 setting value (EV2) | 0.00 | 0.00 to 99.99(L/min) | when 04 is 01 or 02 |
| | | 00000000 | 00000000 to 99999999(L) | when 04 is 03 or 04 |
| P-03 | EV1 hysteresis | 0.50 | 0.00 to 1.00(L/min) | when 03 is 01 or 02 |
| P-04 | EV2 hysteresis | 0.50 | 0.00 to 1.00(L/min) | when 04 is 01 or 02 |
| P-05 | EV1 ON delay | 0 | 0 to 60(s) | when 03 is 01 or 02 |
| P-06 | EV2 ON delay | 0 | 0 to 60(s) | when 04 is 01 or 02 |
| P-07 | Reverse-integrated default | 00000000 | 00000000 to 99999999(L) | when 02 is 02 |
| P-08 | Gas type conversion factor | 1.000 | 0.100 to 8.000 | when 08 is 08 |
| P-09 | Analog output scaling | 100 | 10 to 250(%) | when 09 is 04 |

● CMS0050

| Parameter | Item | Factory setting | Setting range | The conditions of display (Setting mode of function) |
|-----------|-----------------------------|-----------------|-------------------------|--|
| P-01 | Event 1 setting value (EV1) | 0.0 | 0.0 to 999.9(L/min) | when 03 is 01 or 02 |
| | | 00000000 | 00000000 to 99999999(L) | when 03 is 03 or 04 |
| P-02 | Event 2 setting value (EV2) | 0.0 | 0.0 to 999.9(L/min) | when 04 is 01 or 02 |
| | | 00000000 | 00000000 to 99999999(L) | when 04 is 03 or 04 |
| P-03 | EV1 hysteresis | 5.0 | 0.0 to 10.0(L/min) | when 03 is 01 or 02 |
| P-04 | EV2 hysteresis | 5.0 | 0.0 to 10.0(L/min) | when 04 is 01 or 02 |
| P-05 | EV1 ON delay | 0 | 0 to 60(s) | when 03 is 01 or 02 |
| P-06 | EV2 ON delay | 0 | 0 to 60(s) | when 04 is 01 or 02 |
| P-07 | Reverse-integrated default | 00000000 | 00000000 to 99999999(L) | when 02 is 02 |
| P-08 | Gas type conversion factor | 1.000 | 0.100 to 8.000 | when 08 is 08 |
| P-09 | Analog output scaling | 100 | 10 to 250(%) | when 09 is 04 |

● CMS0200/0500/1000/2000

| Parameter | Item | Factory setting | Setting range | The conditions of display (Setting mode of function) |
|-----------|-----------------------------|-----------------|----------------------------|--|
| P-01 | Event 1 setting value (EV1) | 0. | 0 to 9999(L/min) * 1 | when 03 is 01 or 02 |
| | | 00000000 | 00000000 to 99999999(X10L) | when 03 is 03 or 04 |
| P-02 | Event 2 setting value (EV2) | 0. | 0 to 9999(L/min) * 1 | when 04 is 01 or 02 |
| | | 00000000 | 00000000 to 99999999(X10L) | when 04 is 03 or 04 |
| P-03 | EV1 hysteresis | 50. * 2 | 0 to 100(L/min) * 2 | when 03 is 01 or 02 |
| P-04 | EV2 hysteresis | 50. * 2 | 0 to 100(L/min) * 2 | when 04 is 01 or 02 |
| P-05 | EV1 ON delay | 0 | 0 to 60(s) | when 03 is 01 or 02 |
| P-06 | EV2 ON delay | 0 | 0 to 60(s) | when 04 is 01 or 02 |
| P-07 | Reverse-integrated default | 00000000 | 00000000 to 99999999(X10L) | when 02 is 02 |
| P-08 | Gas type conversion factor | 1.000 | 0.100 to 8.000 | when 08 is 08 |
| P-09 | Analog output scaling | 100 | 10 to 250(%) | when 09 is 04 |

 **Note**

- *1 In case of gas type CH_4 on the CMS0200;
and when $P\text{-}\text{CH}_4$ (conversion factor) is set to 0.100 to 0.499, the range becomes 0.0 to 999.5 (in 0.5 intervals). When the factor is set to 0.500 to 8.000, the range becomes 0 to 9999.
However, use at a set point within setting range.
- *2 In case of gas type CH_4 on the CMS0200;
and when $P\text{-}\text{CH}_4$ (conversion factor) is set to 0.100 to 0.499, the factory setting is 5.0 and the setting range becomes 0.0 to 10.0(in 0.5 increments intervals).

 **Handling Precautions**

- Setting value must be in measuring range.



■ **Display OFF mode**

If the  key is held down for at least three seconds, all display is turned off except for the instantaneous flow rate indicator lamp, which blinks.

■ **About integration and reverse-integration**

When the integrated value exceeds 99999999, it is changed to 0 and count up continues. In this case, the event output of integrated flowrate count up is OFF until again reaching the set point. When the reverse-integrated value is 0, the count down stops.

■ **Resetting the integrated value and reverse-integrated value**

To reset the integrated/reverse-integrated value, hold down the  and  keys simultaneously for at least one second with the integrated/reverse-integrated value displayed.

The integrated value is reset to 0 and the reverse-integrated value is reset to the default, and integration/reverse-integration is resumed.

■ What is "Event standby?"

"Event standby" is enabled only on the instantaneous flowrate lower limit value. This function prevents erroneous operation of the lower limit alarm when there is no gas flowrate, for example, when the device is started up. There is no event action until the instantaneous flowrate value once exceeds the event lower limit setting value after the power is turned ON. Event action is normal after the event lower limit setting value has been exceeded once.

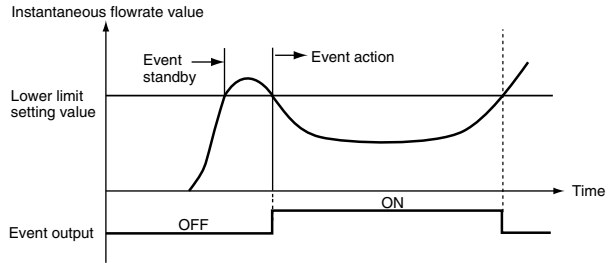

■ Event ON delay

ON delay (0 to 60s) is set for each of events 1 and 2.

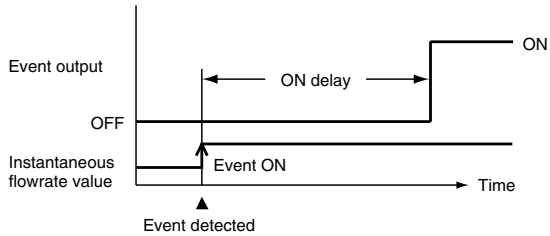

■ Flowrate zero calibration

If the indicated flow rate is not zero even though the actual flow rate is zero, and it seems possible that the sensor's zero point may have shifted, try the following procedure for flowrate zero calibration:

- (1) Display the flowrate or integrated flowrate value.
- (2) Press and hold the **ENT** key.
- (3) After approx. 10 seconds have elapsed, **0.000** blinks on the flowrate display.
- (4) Press and hold **ENT** again.
- (5) After approx. 1 second, **0.000** stops blinking and remains lit. The amount of sensor output at this moment is now treated as zero.
- (6) Press **DISP** key to return to the instantaneous flowrate or integrated flowrate display.

1 Handling Precautions

Use flowrate zero calibration only after ensuring that the flow path contains only the gas being measured, and after stabilizing the actual flow rate at zero.

Chapter 5. TROUBLESHOOTING

■ Remediying trouble

Refer to the following table if trouble occurs:

| Phenomena | Countermeasure |
|---|--|
| Nothing on display | <ul style="list-style-type: none"> • Make sure that power of correct voltage and polarity is being supplied. • Make sure that connectors are correctly connected. |
| <i>RLH1</i> is displayed | <p>The instantaneous flowrate value has exceeded 120% of the measurement range.</p> <p>Reduce the flowrate so that it is within the range, then normal operation will automatically resume.</p> |
| <i>Err1</i> is displayed | <p>Sensor error</p> <ul style="list-style-type: none"> • Make sure that gas is not flowing excessively, or the gas is not flowing reversely. • Make sure that the purging is not performed while power is supplied. • The flowrate becomes within the range, normal operation will automatically resume. If the device does not resume normal operation, contact the azbil Group and ask for repair. |
| <i>Err2</i> is displayed | <p>Memory data error</p> <p>Contact the azbil Group and ask for repair.</p> |
| <i>Err3</i> is displayed | <p>Heater current error of sensor.</p> <p>After closing the gas valve, turning the power off and then on again. If the device does not resume normal operation, contact the azbil Group and ask for repair.</p> |
| <i>Err4</i> is displayed | <p>Sensor heater safety circuit worked.</p> <p>After closing the gas valve, turning the power off and then on again. If the device does not resume normal operation, contact the azbil Group and ask for repair.</p> |
| Signal is output even though the flowrate should be "zero". | <ul style="list-style-type: none"> • Check the piping for any gas leaks. • Check the wiring to make sure that it is correct. |
| Flowrate deviates. | <ul style="list-style-type: none"> • Check the piping for any gas leaks. • Check the piping and connection ports for dirt, oil or other foreign matter. If oil is adhering to these parts, contact the azbil Group. • Check the wiring to make sure that it is correct. • Check the flowrate to see that it does not deviate considerably within several seconds, or that it does not greatly exceed the measurement range. |
| The displayed value is lower than expected. | <ul style="list-style-type: none"> • Check if the gas contains foreign matter such as dust, rust, oil or water. If it seems that there is foreign matter in the flow meter, contact the azbil Group and ask for repair. |
| There should be no flow but the indicated flow rate is higher than zero. | |
| Integration is incremented or reverse integration is decremented even though the instantaneous flowrate indication is "zero". | <ul style="list-style-type: none"> • Check the piping for any gas leaks or check if gas flow stops. <p>There is a possibility that a small volume gas less than the minimum display value is flowing even though the instantaneous flowrate indication is zero. The flowrate less than the minimum indication value is counted in the integration computation.</p> <p>Set the flow deadband to remove the countup of integrated value (or countdown of reverse-integrated value).</p> <p>■ See Function setup</p> |

Chapter 6. SPECIFICATIONS

■ General specifications

| Item | | Model No. | CMS0010 | CMS0050 | CMS0200 | | | | | | | | | | |
|---|--|---|---|---|--|--|---|--|--|---|--|--|--|---|---|
| Applicable gas | | Hydrogen, Helium. Gas must not contain corrosive components (chlorine, sulfur, acid, etc.). | | | | | | | | | | | | | |
| Flow range *1 | | 10L/min (standard) 50L/min (standard) 200L/min (standard) standard indicates the calibration criteria (101.325kPa(1atm), 20°C). | | | | | | | | | | | | | |
| Measurement accuracy *2 101.325kPa, 23°C conversion (χ : measured flowrate) | | <table border="1"> <tr> <td>$0.1 \leq \chi < 2$ L/min $\pm 1\% \text{FS} \pm 1$ digit</td> <td>$0.5 \leq \chi < 10$ L/min $\pm 1\% \text{FS} \pm 1$ digit</td> <td>$2 \leq \chi \leq 10$ L/min $\pm 5\% \text{RD} \pm 1$ digit</td> <td>$10 \leq \chi \leq 50$ L/min $\pm 5\% \text{RD} \pm 1$ digit</td> <td>$2 \leq \chi < 40$ L/min $\pm 1\% \text{FS} \pm 1$ digit</td> <td>$40 \leq \chi \leq 200$ L/min $\pm 5\% \text{RD} \pm 1$ digit</td> </tr> </table> | | | | $0.1 \leq \chi < 2$ L/min $\pm 1\% \text{FS} \pm 1$ digit | $0.5 \leq \chi < 10$ L/min $\pm 1\% \text{FS} \pm 1$ digit | $2 \leq \chi \leq 10$ L/min $\pm 5\% \text{RD} \pm 1$ digit | $10 \leq \chi \leq 50$ L/min $\pm 5\% \text{RD} \pm 1$ digit | $2 \leq \chi < 40$ L/min $\pm 1\% \text{FS} \pm 1$ digit | $40 \leq \chi \leq 200$ L/min $\pm 5\% \text{RD} \pm 1$ digit | | | | |
| $0.1 \leq \chi < 2$ L/min $\pm 1\% \text{FS} \pm 1$ digit | $0.5 \leq \chi < 10$ L/min $\pm 1\% \text{FS} \pm 1$ digit | $2 \leq \chi \leq 10$ L/min $\pm 5\% \text{RD} \pm 1$ digit | $10 \leq \chi \leq 50$ L/min $\pm 5\% \text{RD} \pm 1$ digit | $2 \leq \chi < 40$ L/min $\pm 1\% \text{FS} \pm 1$ digit | $40 \leq \chi \leq 200$ L/min $\pm 5\% \text{RD} \pm 1$ digit | | | | | | | | | | |
| Temperature characteristics *3 -10 to +60°C | | <table border="1"> <tr> <td>Flow range 0 to 75%</td> <td>$\pm 0.10\% \text{FS} / ^\circ \text{C} \pm 1$ digit</td> </tr> <tr> <td>Flow range 75 to 100%</td> <td>$\pm 0.15\% \text{FS} / ^\circ \text{C} \pm 1$ digit</td> </tr> </table> | | | | Flow range 0 to 75% | $\pm 0.10\% \text{FS} / ^\circ \text{C} \pm 1$ digit | Flow range 75 to 100% | $\pm 0.15\% \text{FS} / ^\circ \text{C} \pm 1$ digit | | | | | | |
| Flow range 0 to 75% | $\pm 0.10\% \text{FS} / ^\circ \text{C} \pm 1$ digit | | | | | | | | | | | | | | |
| Flow range 75 to 100% | $\pm 0.15\% \text{FS} / ^\circ \text{C} \pm 1$ digit | | | | | | | | | | | | | | |
| Pressure characteristics *4 | | <table border="1"> <tr> <td>Flow range 0 to 50%</td> <td>$\pm 0.3\% \text{FS} / 0.1 \text{MPa} \pm 1$ digit max.</td> <td colspan="3">$\pm 0.1\% \text{FS} / 0.1 \text{MPa} \pm 1$ digit max.</td> </tr> <tr> <td>0 to 1.0MPa</td> <td>$\pm 3\% \text{RD} \pm 1$ digit max.</td> <td>$\pm 0.1\% \text{RD} / 0.1 \text{MPa} \pm 1$ digit max.</td> <td>$\pm 0.5\% \text{RD} / 0.1 \text{MPa} \pm 1$ digit max.</td> <td>$\pm 0.5\% \text{RD} / 0.1 \text{MPa} \pm 1$ digit max.</td> </tr> </table> | | | | Flow range 0 to 50% | $\pm 0.3\% \text{FS} / 0.1 \text{MPa} \pm 1$ digit max. | $\pm 0.1\% \text{FS} / 0.1 \text{MPa} \pm 1$ digit max. | | | 0 to 1.0MPa | $\pm 3\% \text{RD} \pm 1$ digit max. | $\pm 0.1\% \text{RD} / 0.1 \text{MPa} \pm 1$ digit max. | $\pm 0.5\% \text{RD} / 0.1 \text{MPa} \pm 1$ digit max. | $\pm 0.5\% \text{RD} / 0.1 \text{MPa} \pm 1$ digit max. |
| Flow range 0 to 50% | $\pm 0.3\% \text{FS} / 0.1 \text{MPa} \pm 1$ digit max. | $\pm 0.1\% \text{FS} / 0.1 \text{MPa} \pm 1$ digit max. | | | | | | | | | | | | | |
| 0 to 1.0MPa | $\pm 3\% \text{RD} \pm 1$ digit max. | $\pm 0.1\% \text{RD} / 0.1 \text{MPa} \pm 1$ digit max. | $\pm 0.5\% \text{RD} / 0.1 \text{MPa} \pm 1$ digit max. | $\pm 0.5\% \text{RD} / 0.1 \text{MPa} \pm 1$ digit max. | | | | | | | | | | | |
| Negative pressure characteristics | | <table border="1"> <tr> <td>Flow range 0 to 50%</td> <td>$\pm 0.5\% \text{FS} / 0.01 \text{MPa} \pm 1$ digit max.</td> <td>$\pm 0.2\% \text{FS} / 0.01 \text{MPa} \pm 1$ digit max.</td> <td>$\pm 0.5\% \text{FS} / 0.01 \text{MPa} \pm 1$ digit max.</td> <td>$\pm 0.5\% \text{FS} / 0.01 \text{MPa} \pm 1$ digit max.</td> </tr> <tr> <td>Flow range 50 to 100%</td> <td>$\pm 1\% \text{RD} / 0.01 \text{MPa} \pm 1$ digit max.</td> <td>$\pm 0.5\% \text{RD} / 0.01 \text{MPa} \pm 1$ digit max.</td> <td>$\pm 1\% \text{RD} / 0.01 \text{MPa} \pm 1$ digit max.</td> <td>$\pm 1\% \text{RD} / 0.01 \text{MPa} \pm 1$ digit max.</td> </tr> </table> | | | | Flow range 0 to 50% | $\pm 0.5\% \text{FS} / 0.01 \text{MPa} \pm 1$ digit max. | $\pm 0.2\% \text{FS} / 0.01 \text{MPa} \pm 1$ digit max. | $\pm 0.5\% \text{FS} / 0.01 \text{MPa} \pm 1$ digit max. | $\pm 0.5\% \text{FS} / 0.01 \text{MPa} \pm 1$ digit max. | Flow range 50 to 100% | $\pm 1\% \text{RD} / 0.01 \text{MPa} \pm 1$ digit max. | $\pm 0.5\% \text{RD} / 0.01 \text{MPa} \pm 1$ digit max. | $\pm 1\% \text{RD} / 0.01 \text{MPa} \pm 1$ digit max. | $\pm 1\% \text{RD} / 0.01 \text{MPa} \pm 1$ digit max. |
| Flow range 0 to 50% | $\pm 0.5\% \text{FS} / 0.01 \text{MPa} \pm 1$ digit max. | $\pm 0.2\% \text{FS} / 0.01 \text{MPa} \pm 1$ digit max. | $\pm 0.5\% \text{FS} / 0.01 \text{MPa} \pm 1$ digit max. | $\pm 0.5\% \text{FS} / 0.01 \text{MPa} \pm 1$ digit max. | | | | | | | | | | | |
| Flow range 50 to 100% | $\pm 1\% \text{RD} / 0.01 \text{MPa} \pm 1$ digit max. | $\pm 0.5\% \text{RD} / 0.01 \text{MPa} \pm 1$ digit max. | $\pm 1\% \text{RD} / 0.01 \text{MPa} \pm 1$ digit max. | $\pm 1\% \text{RD} / 0.01 \text{MPa} \pm 1$ digit max. | | | | | | | | | | | |
| Operating pressure range | | -0.07 to 1.0MPa | | | | | | | | | | | | | |
| Pressure resistance | | 1.5MPa | | | | | | | | | | | | | |
| Sampling cycle | | 100±10ms | | | | | | | | | | | | | |
| Output signal (instantaneous flowrate output) | | <table border="1"> <tr> <td>0-5Vdc / 1-5Vdc</td> <td>: Allowable load resistance 250kΩ min. 6Vdc max. even if flowrate exceeds range.</td> </tr> <tr> <td>4-20mAdc</td> <td>: Allowable load resistance 300Ω max. 24mAdc max. even if the flowrate exceeds range.</td> </tr> </table> | | | | 0-5Vdc / 1-5Vdc | : Allowable load resistance 250kΩ min. 6Vdc max. even if flowrate exceeds range. | 4-20mAdc | : Allowable load resistance 300Ω max. 24mAdc max. even if the flowrate exceeds range. | | | | | | |
| 0-5Vdc / 1-5Vdc | : Allowable load resistance 250kΩ min. 6Vdc max. even if flowrate exceeds range. | | | | | | | | | | | | | | |
| 4-20mAdc | : Allowable load resistance 300Ω max. 24mAdc max. even if the flowrate exceeds range. | | | | | | | | | | | | | | |
| Event output | Number of events | 2 | | | | | | | | | | | | | |
| | Output | Open collector (30Vdc, 50mA max.) | | | | | | | | | | | | | |
| | Integration pulse output width | 100ms±10% | | | | | | | | | | | | | |
| | Integration pulse output rate | 1, 10, 100L/pulse | | | 10, 100, 1000L/pulse | | | | | | | | | | |
| External input | Number of input | 1 | | | | | | | | | | | | | |
| | Circuit type on other side | No-voltage contact or open collector | | | | | | | | | | | | | |
| | Contact OFF terminal voltage | 4.5±1V | | | | | | | | | | | | | |
| | Contact ON terminal current | approx. 0.5mA (current flowing to contact) | | | | | | | | | | | | | |
| | Allowable ON contact resistance | 250Ω max. | | | | | | | | | | | | | |
| | Allowable OFF contact resistance | 100kΩ min. | | | | | | | | | | | | | |
| | Allowable ON residual voltage | 0.8V max. (open collector on other side) | | | | | | | | | | | | | |
| | Allowable OFF leakage current | 50μA max. (open collector on other side) | | | | | | | | | | | | | |

| CMS0500 | CMS1000 | CMS2000 |
|---|--|--|
| Hydrogen, Helium. Gas must not contain corrosive components (chlorine, sulfur, acid, etc.). | | |
| 500L/min (standard) | 1000L/min (standard) | 2000L/min (standard) |
| standard indicates the calibration criteria (101325 kPa, 20 °C). | | |
| $5 \leq \chi < 100$ L/min $\pm 1\% \text{FS} \pm 1$ digit | $10 \leq \chi < 200$ L/min $\pm 1\% \text{FS} \pm 1$ digit | $20 \leq \chi < 400$ L/min $\pm 1\% \text{FS} \pm 1$ digit |
| $100 \leq \chi \leq 500$ L/min $\pm 5\% \text{RD} \pm 1$ digit | $200 \leq \chi \leq 1000$ L/min $\pm 5\% \text{RD} \pm 1$ digit | $400 \leq \chi \leq 2000$ L/min $\pm 5\% \text{RD} \pm 1$ digit |
| Flow range 0 to 75% | $\pm 0.10\% \text{FS} / \text{C} \pm 1$ digit | |
| Flow range 75 to 100% | $\pm 0.15\% \text{FS} / \text{C} \pm 1$ digit | |
| $\pm 0.1\% \text{FS} / 0.1 \text{MPa} \pm 1$ digit max. | | |
| $\pm 0.3\% \text{RD} / 0.1 \text{MPa} \pm 1$ digit max. | $\pm 0.5\% \text{RD} / 0.1 \text{MPa} \pm 1$ digit max. | |
| $\pm 0.2\% \text{FS} / 0.01 \text{MPa} \pm 1$ digit max. | $\pm 0.5\% \text{FS} / 0.01 \text{MPa} \pm 1$ digit max. | |
| $\pm 0.5\% \text{RD} / 0.01 \text{MPa} \pm 1$ digit max. | $\pm 1\% \text{RD} / 0.01 \text{MPa} \pm 1$ digit max. | |
| -0.07 to 1.0MPa | | |
| 1.5MPa | | |
| 100 \pm 10ms | | |
| 0-5Vdc / 1-5Vdc : Allowable load resistance 250k Ω min. 6Vdc max. even if flowrate exceeds range. | | |
| 4-20mAdc : Allowable load resistance 300 Ω max. 24mAdc max. even if the flowrate exceeds range. | | |
| 2 | | |
| Open collector (30Vdc, 50mA max.) | | |
| 100ms \pm 10% | | |
| 10, 100, 1000 L/pulse | | |
| 1 | | |
| No-voltage contact or open collector | | |
| 4.5 \pm 1V | | |
| approx. 0.5mA (current flowing to contact) | | |
| 250 Ω max. | | |
| 100k Ω min. | | |
| 0.8V max. (open collector on other side) | | |
| 50 μ A max. (open collector on other side) | | |

Chapter 6. SPECIFICATIONS

| Item | | Model No. | | CMS0010 | CMS0050 | CMS0200 |
|----------------------------------|------------------------|---|----------------------|----------------------|----------------------|----------------------|
| | | Min. display | Resolution | 0.01L/min (standard) | 0.1L/min (standard) | 1L/min (standard) *5 |
| Display | Flowrate display | 7-segment LED 4-digit | | | | |
| | Instantaneous flowrate | Min. display | 0.01L/min (standard) | 0.1L/min (standard) | 1L/min (standard) *5 | |
| | | Resolution | 0.01L/min (standard) | 0.1L/min (standard) | 1L/min (standard) *5 | |
| | Integrated flowrate | Display unit | 1L | | | 10L |
| Display range | | 0 to 99999999 | | | | |
| Data storage | | Data is written to memory every 10min. (Integrated value can be reset by operating the keys or external contact input.) | | | | |
| Power supply | Rated voltage | 12 to 24Vdc | | | | |
| | Supply voltage range | 11.4 to 25.2Vdc | | | | |
| | Current consumption | 100mA max. | | | | |
| | Electrical interface | Harness with connector exclusive to CMS (sold separately) | | | | |
| Operating temperature range | | -10 to 60 °C | | | | |
| Operating humidity range | | 10 to 90%RH (condensation not allowed) | | | | |
| Storage temperature range | | -20 to +70 °C (condensation not allowed) | | | | |
| Connection method | | 9/16-18UNF Rc1/4 1/4Swagelok 1/4VCR | | | | |
| Mounting position | | Horizontal mounting. (Meter section must not face down.) | | | | |
| Body material | | SUS316 | | | | |
| Case material | | Polycarbonate | | | | |
| Material of gas contacting parts | | SUS316, fluoro-resin rubber | | | | |
| Mass | | approx. 800g | | | | |
| Applicable standards | | EN61326-1 : 1997 Amendment A1 : 1998, A2:2001, A3:2003 | | | | |

*1 The following tables show the maximum measured flowrate and output voltage for each gas type: (The output at the maximum measured flowrate is indicated as the voltage.)

| Gas type | CMS0010 | | CMS0050 | |
|------------|---|--------------------|---|--------------------|
| | Max. measured flowrate [L/min (standard)] | Output voltage [V] | Max. measured flowrate [L/min (standard)] | Output voltage [V] |
| Hydrogen | 10 | 5 | 50 | 5 |
| Helium | 10 | 5 | 50 | 5 |
| User setup | 10 x Gas type conversion factor | 5 | 50 x Gas type conversion factor | 5 |

| Gas type | CMS0200 | | CMS0500 | |
|------------|---|--------------------|---|--------------------|
| | Max. measured flowrate [L/min (standard)] | Output voltage [V] | Max. measured flowrate [L/min (standard)] | Output voltage [V] |
| Hydrogen | 200 | 5 | 500 | 5 |
| Helium | 200 | 5 | 500 | 5 |
| User setup | 200 x Gas type conversion factor | 5 | 500 x Gas type conversion factor | 5 |

| Gas type | CMS1000 | | CMS2000 | |
|------------|---|--------------------|---|--------------------|
| | Max. measured flowrate [L/min (standard)] | Output voltage [V] | Max. measured flowrate [L/min (standard)] | Output voltage [V] |
| Hydrogen | 1000 | 5 | 2000 | 5 |
| Helium | 1000 | 5 | 2000 | 5 |
| User setup | 1000 x Gas type conversion factor | 5 | 2000 x Gas type conversion factor | 5 |

| CMS0500 | CMS1000 | CMS2000 |
|---|---------|-------------------|
| 7-segment LED 4-digit | | |
| 1L/min (standard) | | 5L/min (standard) |
| 1L/min (standard) | | 5L/min (standard) |
| 10L | | |
| 0 to 99999999 | | |
| Data is written to memory every 10min. (Integrated value can be reset by operating the keys or external contact input.) | | |
| 12 to 24Vdc | | |
| 11.4 to 25.2Vdc | | |
| 100mA max. | | |
| Harness with connector exclusive to CMS (sold separately) | | |
| -10 to 60°C | | |
| 10 to 90%RH (condensation not allowed) | | |
| -20 to +70°C (condensation not allowed) | | |
| 3/4-16UNF Rc1/2 1/2Swagelok 3/8VCR or equivalent product | | |
| Horizontal mounting. (Meter section must not face down.) | | |
| SUS316 | | |
| Polycarbonate | | |
| SUS316, fluoro-resin rubber | | |
| approx. 1400g | | approx. 2000g |
| EN61326-1 : 1997 Amendment A1 : 1998, A2:2001, A3:2003 | | |

*2 23°C shows the ambient temperature during adjustment.

Measurement flowrate \times L/min (standard).

*3 Amount of change on a flowrate referenced to 23°C at -10 to +60°C, 101.325 kPa state.

*4 Amount of change on a flowrate referenced to atmospheric pressure in a 20°C, -0.07 to 1.0MPa state.
Only for the flow range 50 to 100% in the CMS0010, this specifies for the full range of 0 to 1.0MPa.

*5 When the gas type conversion factor has been set to 0.100 to 0.499, the minimum display and display resolution becomes 0.5L/min (standard).

External dimensions

CMS0010/0050/0200

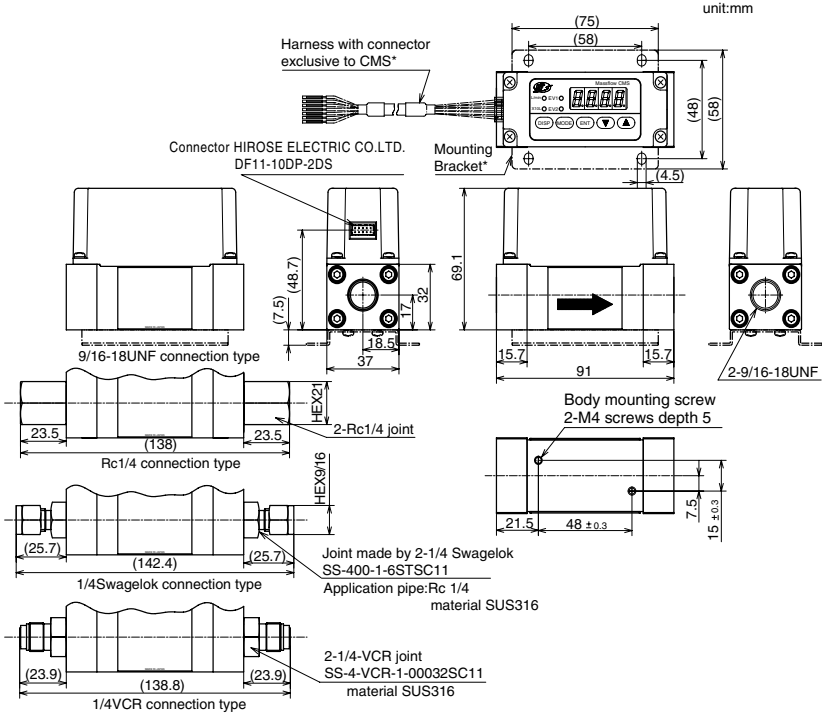

* Optional Parts (Sold separately)

Harness with connector exclusive to CMS : Model No. 81446594-XXX
 Mounting bracket : Model No. 81446628-001

Note

The upper figure shows CMS0200.

● CMS0500/1000

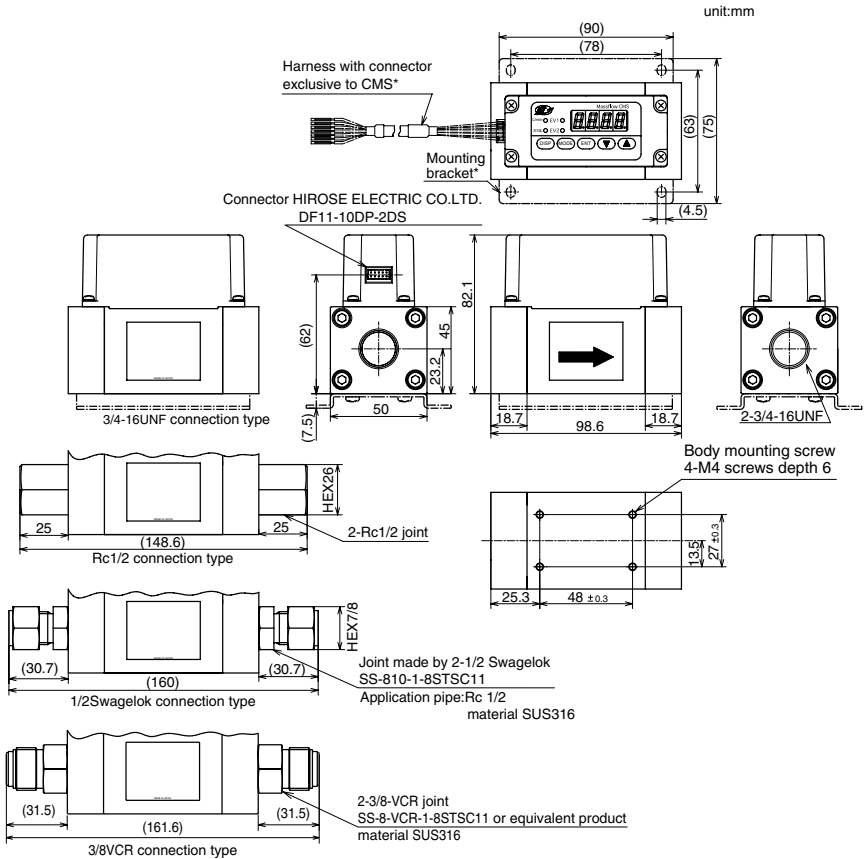

* Optional Parts (Sold separately)

Harness with connector exclusive to CMS : Model No. 81446594-XXX
 Mounting bracket : Model No. 81446721-001

Note

The upper figure shows CMS0500.

● CMS2000

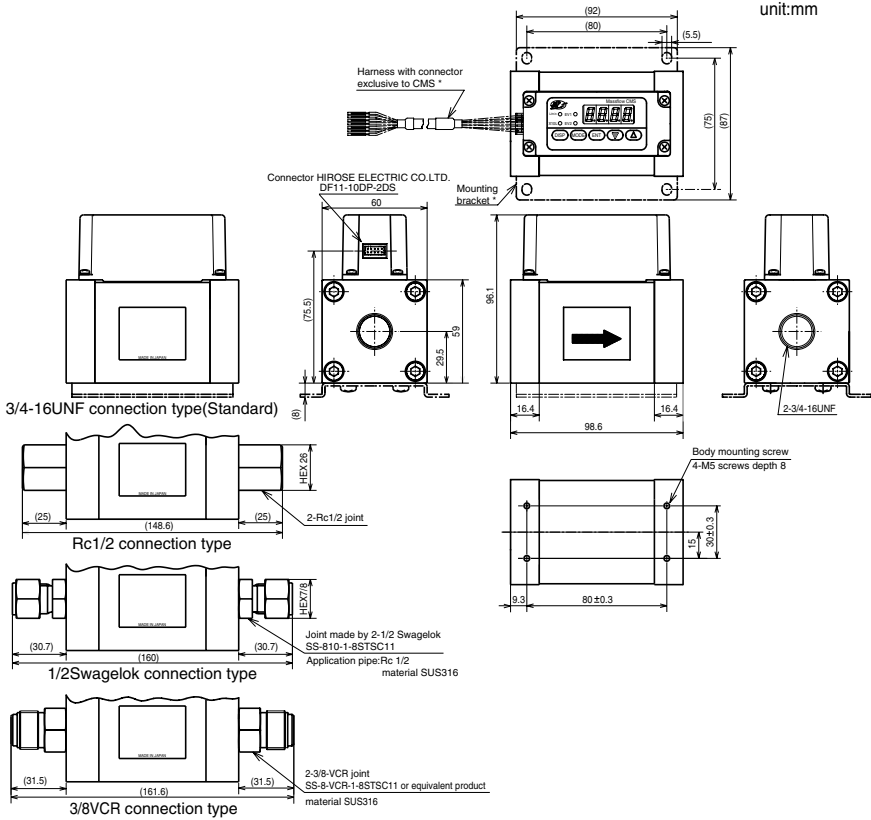

* Optional Parts (Sold separately)

Harness with connector exclusive to CMS : Model No. 81446594-XXX
 Mounting bracket : Model No. 81446856-001

● **Harness with connector exclusive to CMS 81446594-ITEM**

ITEM:005, 006

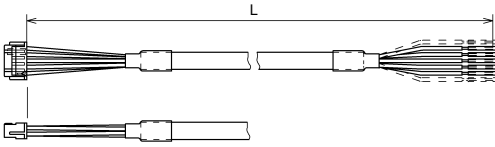

| ITEM | L(mm) | No. of conductor |
|------|-----------------------------------|------------------|
| 005 | 2000 ⁺⁵⁰ ₀ | 8 |
| 006 | 5000 ⁺²⁵⁰ ₀ | 8 |
| 007 | 2000 ⁺⁸⁰ ₀ | 10 |
| 008 | 5000 ⁺²⁵⁰ ₀ | 10 |

ITEM:007, 008

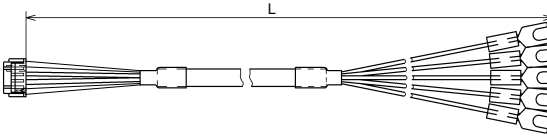

● **AC/DC adaptor 81446957-001**

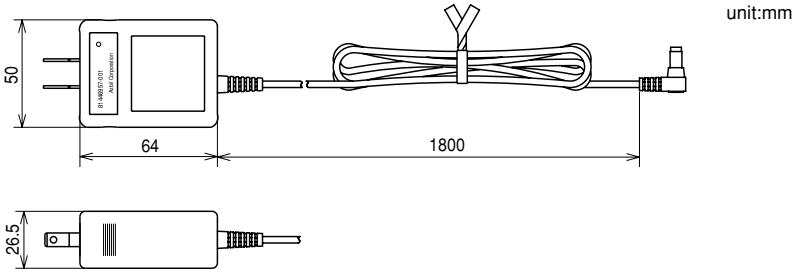

Note : The harness for AC/DC adaptor (81446594-030) is necessary for the CMS to connect the AC/DC adaptor

● **Harness for AC/DC adaptor 81446594-030**

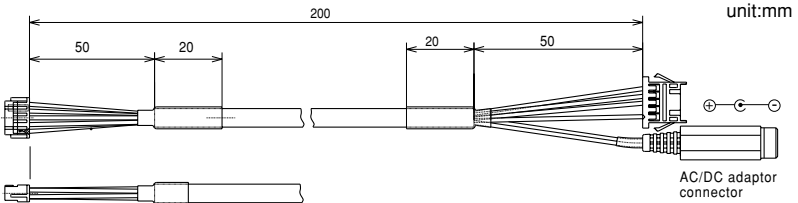

● **Mounting bracket 81446628-001 (CMS0010/0050/0200)**

Material: SUS304

unit:mm

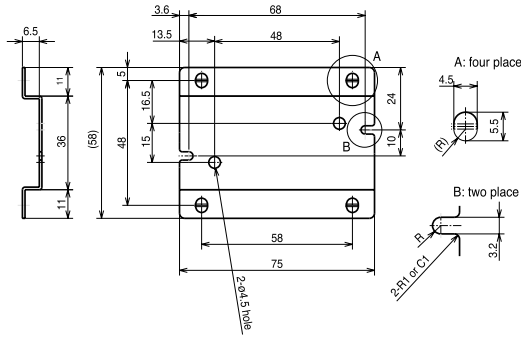

● **Mounting bracket 81446721-001 (CMS0500/1000)**

Material: SUS304

unit:mm

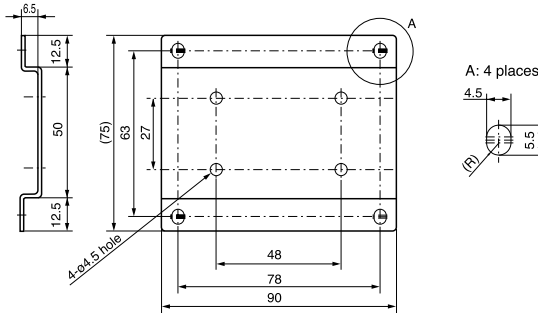

● **Mounting bracket 81446856-001 (CMS2000)**

Material: SUS304

unit:mm

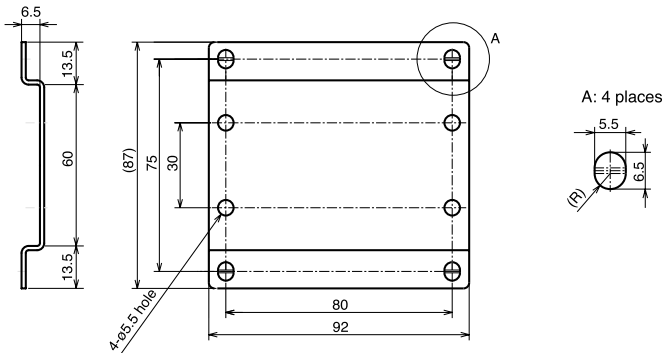

■ Pressure loss

• CMS0010

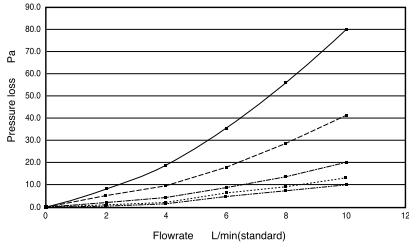

• CMS0050

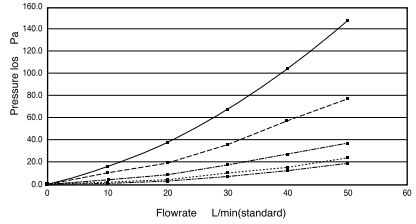

Primary pressure



• CMS0200

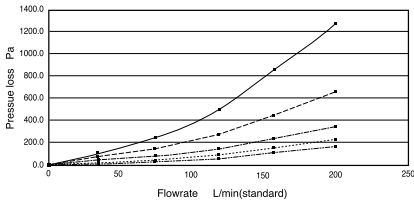

• CMS0500

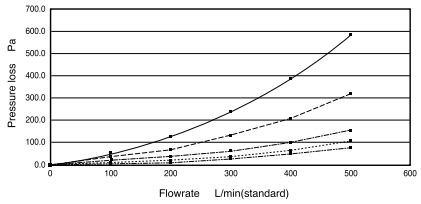

• CMS1000

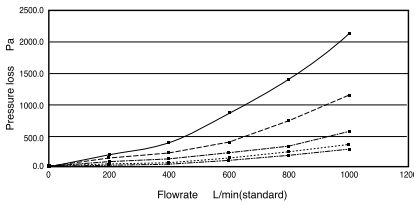

• CMS2000

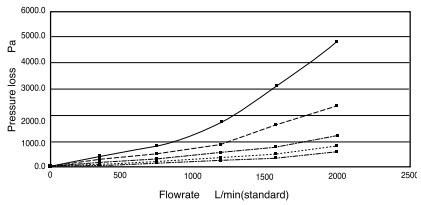

Primary pressure



azbil

Specifications are subject to change without notice. (09)

Azbil Corporation

Advanced Automation Company

1-12-2 Kawana, Fujisawa

Kanagawa 251-8522 Japan

URL: <http://www.azbil.com>

1st edition: Nov. 2001 (W)

5th edition: Apr. 2012 (F)