

azbil

**MagneW3000 PLUS
HART[®] Communicator**

User's Manual

Azbil Corporation

**CM2-MGG21H-2001
2nd edition**

Copyright, Notices and Trademarks

© 2004-2012 Azbil Corporation All Rights Reserved.

While this information is presented in good faith and believed to be accurate, Azbil Corporation disclaims the implied warranties of merchantability and fitness for a particular purpose and makes no express warranties except as may be stated in its written agreement with and for its customer.

In no event is Azbil Corporation liable to anyone for any indirect, special or consequential damages. This information and specifications in this document are subject to change without notice.

MagneW3000 is a trademark of Azbil Corporation.

HART[®] is registered trademark of the HART Communication Foundation.

Table of Contents

1: Preparation for communication, verification and cautions on use.....	1
1-1: Wiring between converter and HART® Communicator	1
1-1-1: For internal power supply	1
1-1-2: For external power supply	1
1-2: Verifying communication.....	2
1-3: Setting the converter.....	3
1-3-1: Setting data setter control card switches	3
1-3-2: Setting main card switches	4
2: Setting and calibrating devices using the HART® Communicator	6
2-1: Setting procedures.....	6
2-1-1: Flow units	6
2-1-2: Range.....	8
2-1-3: Damping constant	8
2-1-4: Detector diameter.....	9
2-1-5: Detector constants	10
2-1-6: Low flow cutoff	11
2-1-7: Unit of pulse weight.....	11
2-1-8: Pulse weight.....	12
2-1-9: Pulse width.....	13
2-1-10: Reset value of integral counter	14
2-2: Calibrating and inspecting the device	15
2-2-1: Zero point adjustment	15
2-2-2: 4 mA and 20 mA current output adjustment.....	16
2-2-3: Pulse output check.....	20
3: Other functions of HART® Communicator	22
3-1: Settings not related to output.....	22
3-2: Verifying the device status and other menus	24
3-2-1: Online.....	24
3-2-2: Process variables.....	24
3-2-3: Device status.....	24
3-2-4: Sensor Info.....	26
3-2-5: Device info	27
3-2-6: Review	27
4: Table of HART® Communicator menus for Magnew3000 PLUS Series	28

List of Figure

Figure 1	HART® Communicator wiring connection (for internal power supply)	1
Figure 2	HART® Communicator wiring connection (for external power supply).....	1
Figure 3	Online menu.....	2
Figure 4	Communication not available	2
Figure 5	Setting of data setter's control card switches	3
Figure 6	Switch setting on main card (for internal power supply type).....	4
Figure 7	Switch setting on main card (for external power supply type).....	4
Figure 8	Device setup menu.....	6
Figure 9	Basic setup menu	7
Figure 10	Selection of flow rate unit.....	7
Figure 11	Transmitting the setting	7
Figure 12	Range input.....	8
Figure 13	Damping constant input	8
Figure 14	Detailed setup menu.....	9
Figure 15	Sensor menu.....	9
Figure 16	Sensor config menu.....	9
Figure 17	Selecting a detector diameter	10
Figure 18	Transmitting the setting	10
Figure 19	Input of detector constant.....	10
Figure 20	Setting of low flow cutoff.....	11
Figure 21	Totalizer menu	11
Figure 22	Puls outp config menu	11
Figure 23	Selection of pulse weight unit.....	12
Figure 24	Transmitting the setting	12
Figure 25	Demand for data transfer	12
Figure 26	Setting the pulse weight	13
Figure 27	Pulse width input.....	13
Figure 28	Integral counter reset value input.....	14
Figure 29	Setting data transfer	14
Figure 30	Diag/Service menu.....	15
Figure 31	Please wait message.....	15
Figure 32	Zero point adjustment start message.....	15
Figure 33	Zero point adjustment in progress message.....	16
Figure 34	Zero point adjustment failure.....	16
Figure 35	Warning for current adjustment.....	16
Figure 36	Message stating to connect meter	17
Figure 37	Message to start current adjustment.....	17
Figure 38	Current value input display.....	17
Figure 39	Verification of current output	18
Figure 40	Message to start current adjustment.....	18
Figure 41	Current value input	18
Figure 42	Verification of current output	19
Figure 43	Forcible current output release message.....	19
Figure 44	Message to urge connection between device and system	19
Figure 45	Message to start pulse output check.....	20
Figure 46	Selection display for pulse output check	20
Figure 47	Pulse output entry	20
Figure 48	Forcible pulse output release message.....	21
Figure 49	Forcible pulse output warning	21

List of Figure

Figure 50	Device info menu	22
Figure 51	Setting the tag	23
Figure 52	Setting the descriptor	23
Figure 53	Setting the message.....	23
Figure 54	Setting the date.....	23
Figure 55	Process variables.....	24
Figure 56	Device status	24
Figure 57	Error	25
Figure 58	Inquiring to ignore error.....	25
Figure 59	Sensor info	26

1 : Preparation for communication, verification and cautions on use

This section describes the preparation necessary for communication between a MagneW3000 and a HART[®] Communicator. This section also covers the procedure to verify communication. The first step for preparation is to perform wiring between the converter and the HART[®] Communicator. After wiring has been completed, turn the power on and verify that communications are functioning properly.

1-1: Wiring between converter and HART[®] Communicator

There are two different methods of wiring for an internal power supply and external power supply.

1-1-1: For internal power supply

Connect the HART[®] Communicator as shown in Figure 1. A 250 Ω resistor must be installed on the receiving end of the output current. There is no polarity on the HART[®] Communicator terminal.

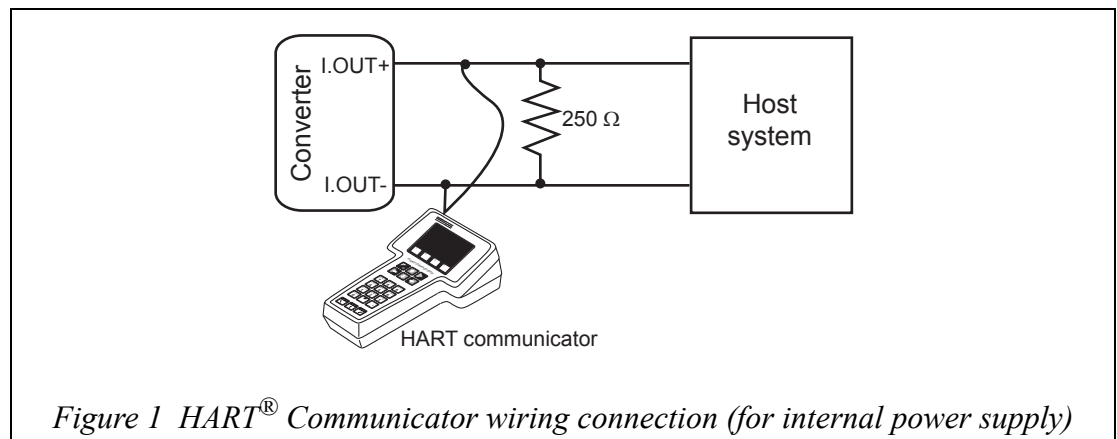

1-1-2: For external power supply

Connect the HART[®] Communicator as shown in Figure 2. A 250 Ω resistor must be installed on the receiving end of the output current. There is no polarity on the HART[®] Communicator terminal.

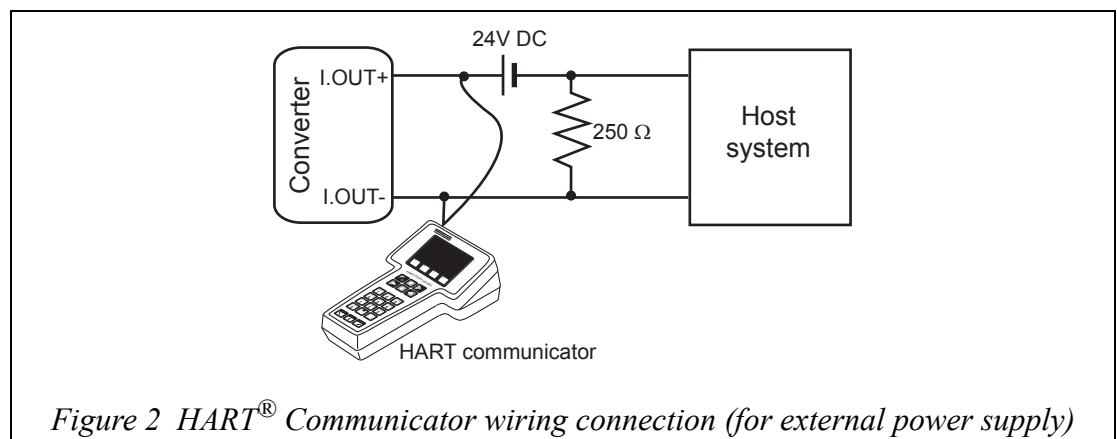

1-2: Verifying communication

After the HART[®] Communicator has been properly interconnected, turn the device's power on. For the external power supply model, turn on the external power supply before turning the device power on.

Once the setting and wiring connections are correct, the HART[®] Communicator's display shows an online menu as shown below and a HART mark will flicker in the upper right hand corner of the display.

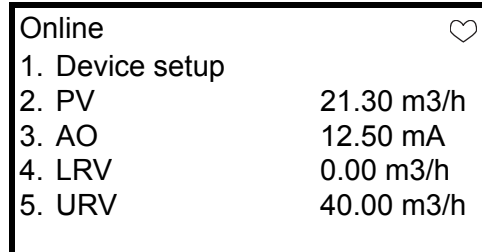

Online		♡
1. Device setup		
2. PV	21.30 m3/h	
3. AO	12.50 mA	
4. LRV	0.00 m3/h	
5. URV	40.00 m3/h	

Figure 3 Online menu

If the display is not as shown in Figure 3 but as shown in Figure 4 below, no communications are being made. Recheck the HART[®] Communicator connections and the setting of converter. (The setting of the converter is described below.)

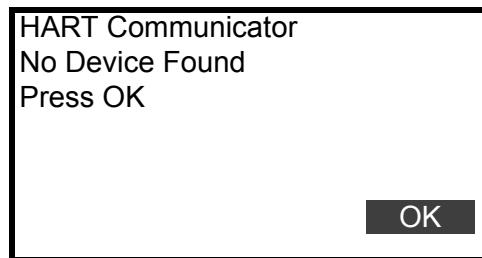

Figure 4 Communication not available

1-3: Setting the converter

For the converter to communicate with the HART[®] Communicator, two kinds of switches need to be set. One kind is located on the data setter's control card and the other on the main card. (These switches are factory set.)

1-3-1: Setting data setter control card switches

The data setter's control card switches are located as shown by the black rectangular blocks in Figure 5(b). Set these switches as illustrated in Figure 5(a). Switches 1 and 2 should be ON and 3 and 4 should be OFF.

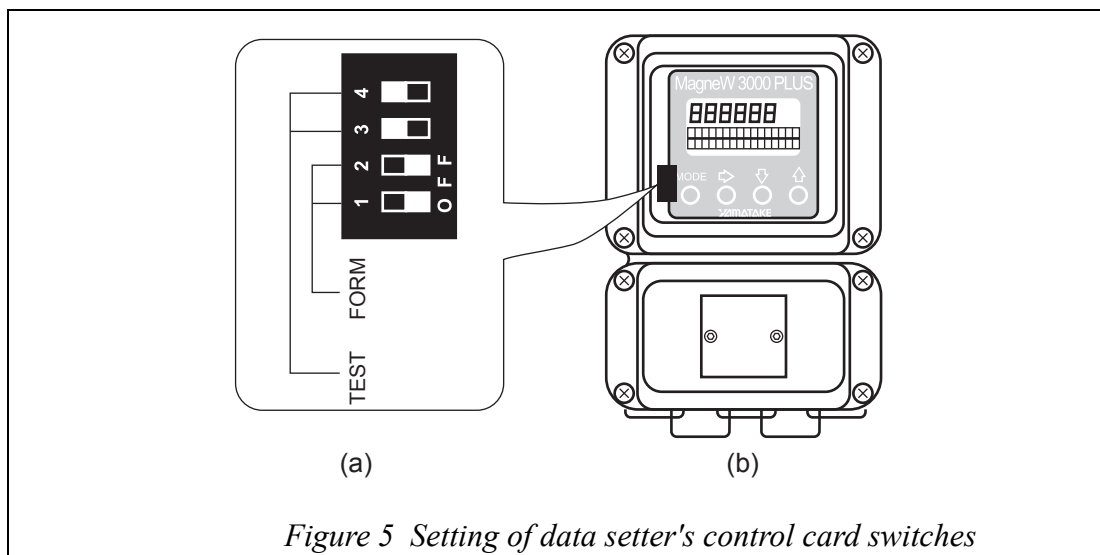

1-3-2: Setting main card switches

The switches that require setting are located in the locations shown by the black rectangular blocks in Figure 6(b) and Figure 7(b). (The same switches are shown in both figures.) There are two types of switch settings: for internal power supply for current output or external supply for the output.

For internal power supply type

Set the switches as shown in Figure 6(a). Move the switches in the direction of black block in the figure.

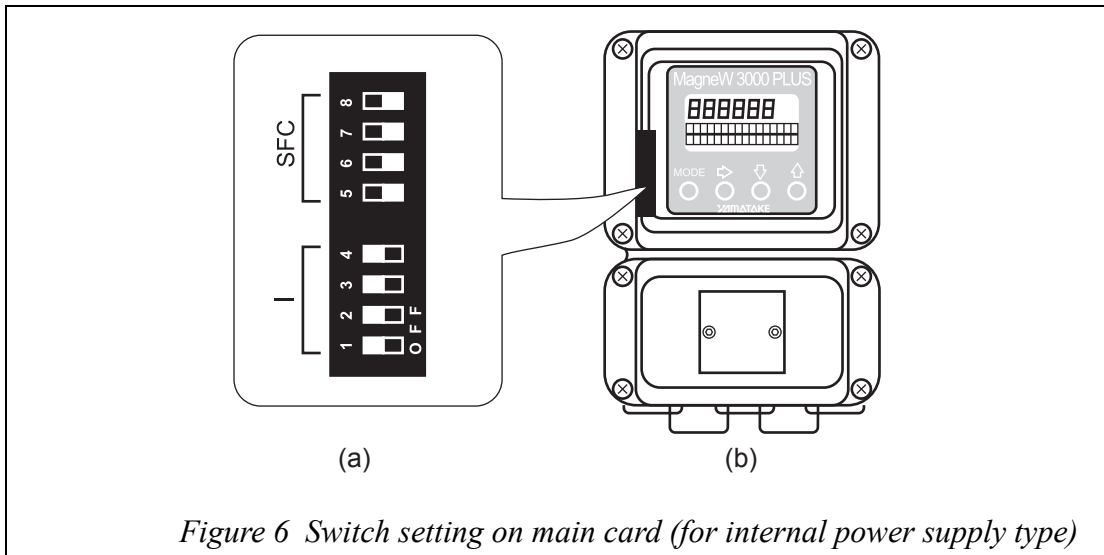

Figure 6 Switch setting on main card (for internal power supply type)

For external power supply type

Set the switches as shown in Figure 7 (a). Move the switches to the direction of black blocks in the figure.

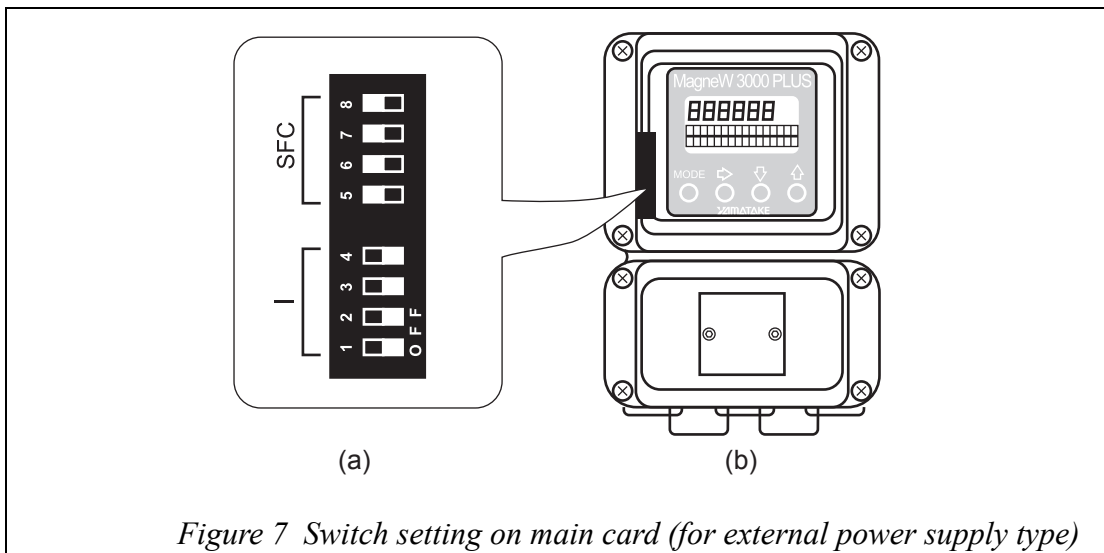

Figure 7 Switch setting on main card (for external power supply type)



Do not remove the HART[®] Communicator cable from the converter while executing communication. If the cable is disconnected during data setting transmission there will be no data transfer to converter.

2 : Setting and calibrating devices using the HART[®] Communicator

The HART[®] Communicator enables the user to set a MagneW3000 PLUS Series device as well as allowing them to adjust and check the output of the device and to inspect the device. The following values can be set using the HART[®] Communicator:

- Flow unit
- Range
- Dumping constants
- Detector diameter
- Low flow cut
- Unit of pulse weight
- Pulse width
- Reset value of the integral counter
- Tag

Also, the following calibrations and inspection can be made:

- Zero point adjustment
- Current output calibration at 4mA and 20mA
- Pulse output inspection

For a detailed list of all the menus, see the HART[®] Communicator's menu table for the MagneW3000 PLUS Series at the back of this manual.

2-1: Setting procedures

The procedures to set various device values are described in this section.

2-1-1: Flow units

The unit for the flow is to be set as follows:

1. Select “1. Device setup” from online menu 1 (Figure 3). The device setup menu will then be displayed. (Figure 8)

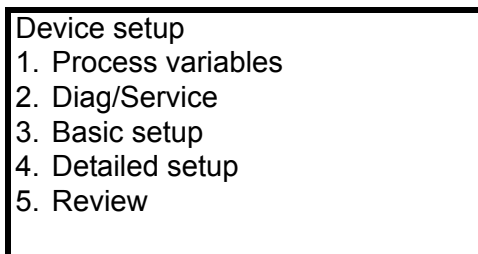

Figure 8 Device setup menu

2. Select “3. Basic setup” from the menu and then the basic setup menu will be displayed. (Figure 9)

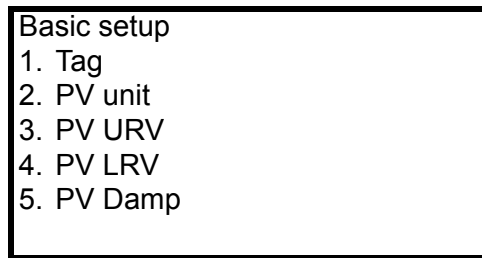

Figure 9 Basic setup menu

3. Select “2. PV unit” from the basic setup menu.
4. Once the display as shown in Figure 10 appears, move the arrow key up or down to select a flow unit. After making a selection, press F4 (ENTER). If F3 (ESC) is pressed here, the selection will be canceled and the display will return to the basic menu.

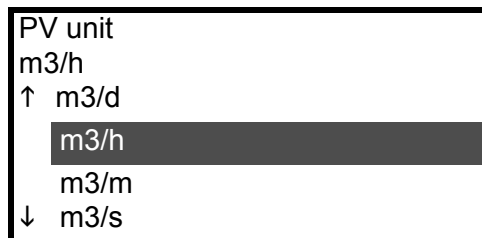

Figure 10 Selection of flow rate unit

5. After pressing F4 (ENTER) and returning to the basic menu, press F2 (SEND). The HART mark will appear in the upper right hand corner while HART is communicating with the device. (Figure 11)

Once communication is complete, the HART mark will disappear.

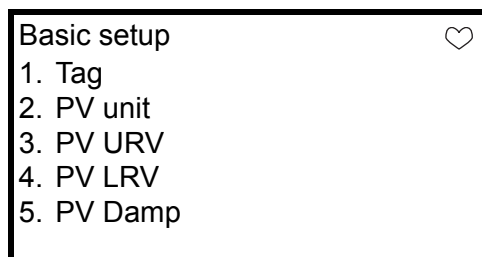

Figure 11 Transmitting the setting

2-1-2: Range

The upper limit of the flow range is set as follows:

1. Select “3. PV URV” from basic setup menu.
2. Use the numeric keys to enter a new range value in the value input display. Up to six digits including a decimal point can be entered. (Figure 12)

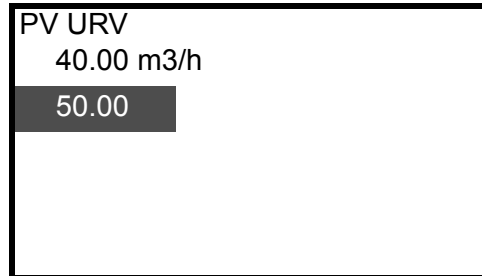

Figure 12 Range input

3. Once a new value is entered, press F4 (ENTER) to return to the basic setup menu. If F3 (ESC) is pressed, the change is canceled and the display returns to the basic setup menu.
4. After returning to the basic setup menu, press F2 (SEND). The HART[®] Communicator mark will appear on the upper right hand corner while HART is communicating with the device. (Figure 11) The mark will disappear once communication has properly completed.

The low limit of the range is always 0 and cannot be changed. Do not select “PVLRV” from the basic setup menu. If selected, the display will show an input value for the low limit of the range as shown in Figure 12. Any input other than 0 cannot be set to converter. Doing so will result in an error.

2-1-3: Damping constant

To change the dumping constant, proceed as follows:

1. Select “5. PV Damp” from the basic setup menu. (Figure 9)
2. Once the display (Figure 13) appears, enter a range value using the numeric keys. The range value that can be entered must be from 0.5s to 1.99s in increments of 0.1. Any other value is unacceptable and will result in an error message being displayed.

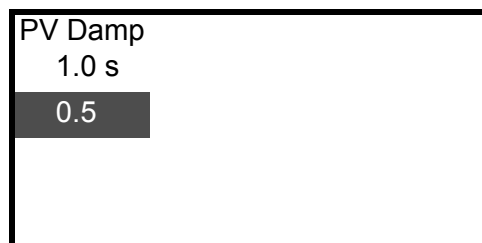

Figure 13 Damping constant input

3. After the value has been entered, press F4 (ENTER) to return to the basic menu. If F3 (ESC) is pressed here, the change will be aborted and the display returns to the basic setup menu.

4. After returning to the basic setup menu, press F2 (SEND). The HART[®] Communicator mark will appear in the upper right hand corner while HART is communicating with the device. (Figure 11) The mark will disappear once communication is properly completed.

2-1-4: Detector diameter

Proceed as follows to change the detector diameter setting for the converter:

1. Select “4. Detailed setup” from the device setup menu. (Figure 8)
2. Select “1. Sensor” from the detailed setup menu. (Figure 14)

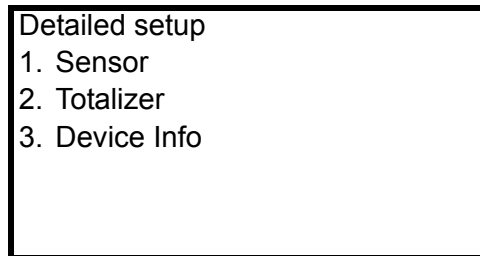

Figure 14 Detailed setup menu

3. From the sensor menu (Figure 15), select “2. Sensor config”.

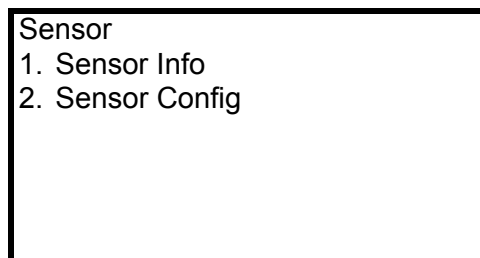

Figure 15 Sensor menu

4. From the Sensor Config menu (Figure 16), select “1. Flow tube size”.

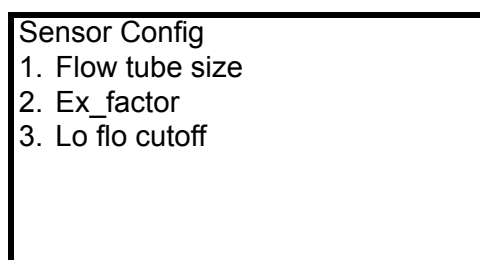

Figure 16 Sensor config menu

- When the display as shown in Figure 17 appears, use the up/down arrow keys to select a detector diameter. After making a selection, press F4 (ENTER) to return to the Sensor Config menu. If F3 (ESC) is pressed here, the change will be aborted and the display will return back to the basic setup menu.

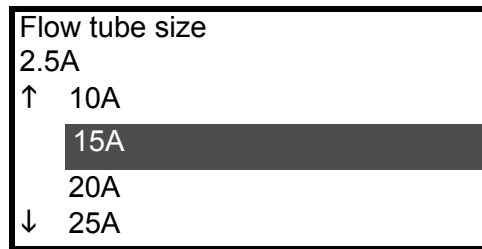

Figure 17 Selecting a detector diameter

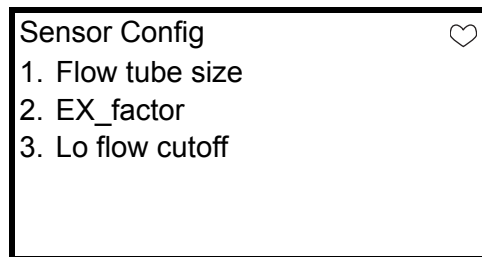

Figure 18 Transmitting the setting

- Once returning to the Sensor Config menu, select F2 (SEND) to transmit the change to the converter. The HART[®] Communicator mark will appear in the upper right hand corner while HART is communicating with the device. (Figure 18) The mark will disappear once communication is properly completed.

2-1-5: Detector constants

To change detector time constant, follow the steps described below:

- From the Sensor Config menu (Figure 16), select “2. Ex_factor”.
- A numerical value input display (Figure 19) will then appear. Use the numeric keys to input a detector constant. Once the input has been completed, press F4 (ENTER) to return to the Sensor Config menu. If F3 (ESC) is pressed here, the change will be aborted and you will be taken back to the original menu

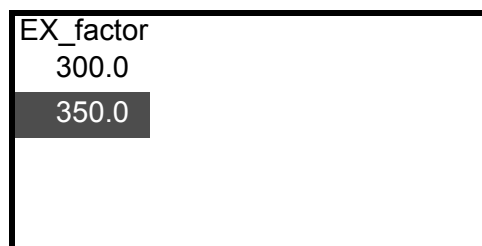

Figure 19 Input of detector constant

- After returning to the Sensor Config menu, select F2 to transmit the change to the converter. The HART[®] Communicator mark will appear in the upper right hand corner while HART is communicating with the device. (Figure 18) The mark will disappear once communication is properly completed.

2-1-6: Low flow cutoff

To set the low flow cutoff, proceed as follows:

1. From the Sensor Config menu (Figure 16), select “3. Lo flo cutoff”.
2. Once the display as in Figure 20 appears, use the up or down keys to select “OFF” or a value from 0% to 10%. After a selection has been made, press F4 (ENTER) to return to the Sensor Config menu. If F3 (ESC) is pressed here, the change will be aborted and you will be returned to the Sensor Config menu.

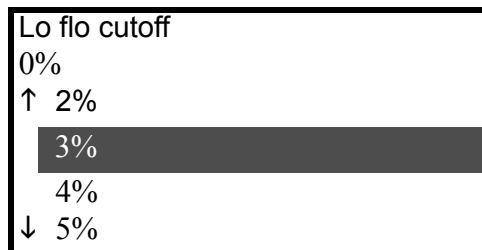

Figure 20 Setting of low flow cutoff

2-1-7: Unit of pulse weight

The pulse weight unit is set as follows:

1. Select “2. Totalizer” from the detailed setup menu. (Figure 14)
2. Select “1. Pulse output config.” from the totalizer menu. (Figure 21)

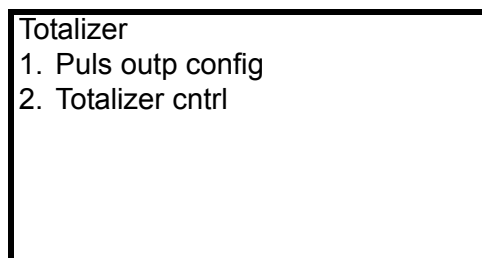

Figure 21 Totalizer menu

3. Select “1. Puls out unit” from the puls outp config menu.

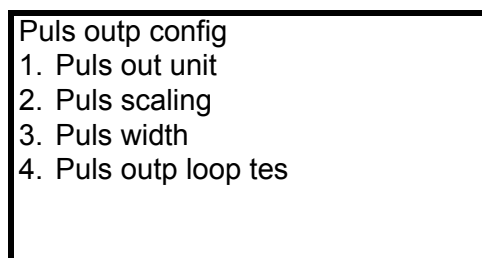

Figure 22 Puls outp config menu

4. When the display as that shown in Figure 23 appears, use the up or down arrow to select the required unit from the six types listed. (kg/P, g/p, t/P, cm³/P, l/P, m³/P)
- After making a selection, press F4 to return to the puls outp config menu. If F3 (ESC) is pressed here, the change will be aborted and you will be taken back to the original menu.

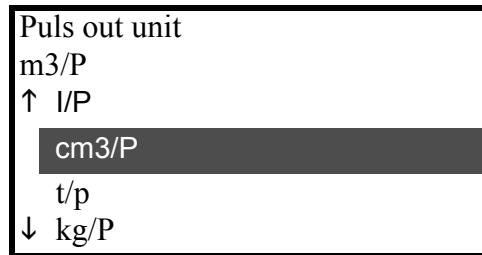

Figure 23 Selection of pulse weight unit

5. After returning to the Puls outp config menu, select F2 (SEND) to transmit the change to the converter. The HART[®] communicator mark will appear in the upper right hand corner of the display while HART is communicating with device. (Figure 24) The mark will disappear once communication has been properly completed.

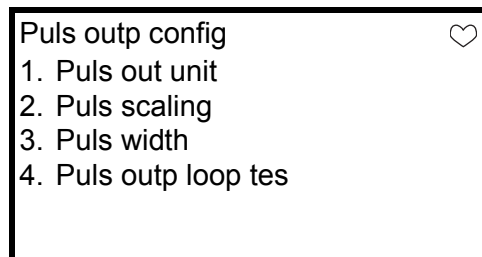

Figure 24 Transmitting the setting

2-1-8: Pulse weight

The pulse weight is set as follows:

1. Select “2. Puls scaling” from the Puls outp confi menu. (Figure 22) If the pulse weight has been changed prior to this step but the change has not been transmitted to the converter, a message demanding the transfer will appear on the display. (Figure 25) Press F4 (OK) here.

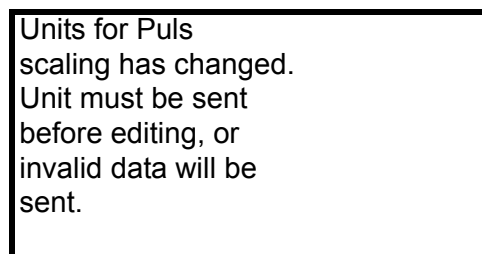

Figure 25 Demand for data transfer

2. A display to input a value for the pulse weight then appears. (Figure 26) Enter a 7-digit number including the decimal point. Once a value has been inputted, press F4

(ENTER) to return to the Puls outp config menu. If F3 (ESC) is pressed here, the change is aborted

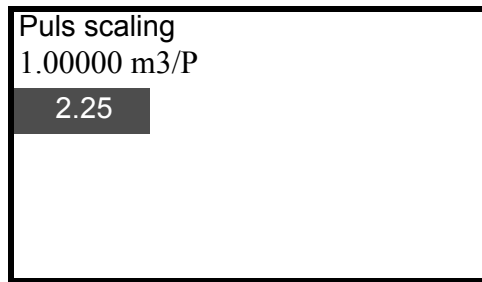

Figure 26 Setting the pulse weight

3. After returning to the Puls outp config menu, select F2 (SEND) to transmit the change to the converter. The HART[®] Communicator mark will appear in the upper right hand corner while HART is communicating with the device. (Figure 18) The mark will disappear once communication has been properly completed.

2-1-9: Pulse width

The pulse width is set as follows:

1. Select “3. Puls width” from the Puls outp config menu. (Figure 22)
2. A display for numerical value entry will then appear. (Figure 27) Enter a six-digit number including a decimal point for the pulse width. Once the number has been inputted, press F4 (ENTER) to return to the Puls outp config menu. If F3 (ESC) is pressed here, the change will be aborted and you will be returned to the original menu.

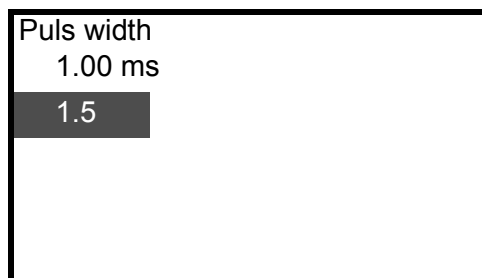

Figure 27 Pulse width input

3. After returning to the Puls output config menu, select F2 (SEND) to transmit the change to the converter. The HART[®] Communicator mark will appear in the upper right hand corner while HART is communicating with the device. (Figure 24) The mark will disappear once communication has been properly completed.

2-1-10: Reset value of integral counter

The integral counter's start value for integration is set as follows:

1. Select "2. Totalizer cntl" from the totalizer menu. (Figure 21)
2. A ten-digit number can be entered. Use the numeric keys to input a new value. Once a new value has been inputted, press F4 (ENTER) to return to the Totalizer menu. If F3 (ESC) is pressed here, the change will be aborted.

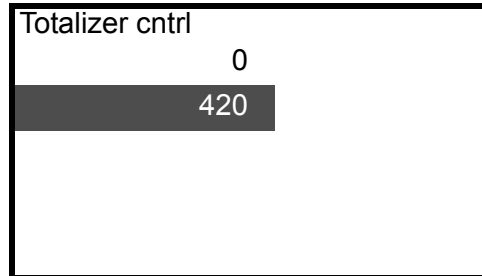

Figure 28 Integral counter reset value input

3. After returning to the totalizer menu, press F2 (SEND) to transmit the change to the converter. The HART[®] Communicator mark will appear in the upper right hand corner while HART is communicating with the device. (Figure 24) The mark will disappear once communication has been properly completed.

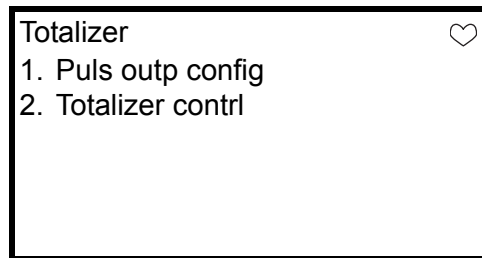

Figure 29 Setting data transfer

2-2: Calibrating and inspecting the device

Device calibration and inspection procedures using the HART[®] Communicator are described here.

2-2-1: Zero point adjustment

Follow the steps described below to set the momentarily flow of static pressure to zero.

1. Stop and make static the fluid in the flowmeter to be calibrated.
2. Select “2. Diag/Service” from the device set up menu. (Figure 8) The Diag/Service menu will then be displayed as shown in Figure 30.

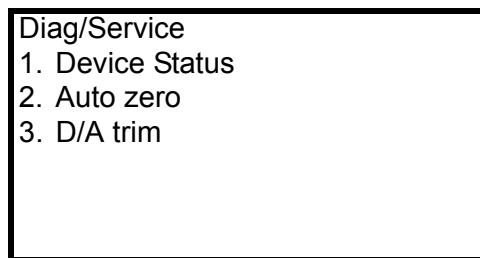

Figure 30 Diag/Service menu

3. Select “2. Auto zero” from the Diag/Service menu.
4. When Auto zero is selected, a “Please wait” message will momentarily appear. (Figure 31) The display then changes to that shown in Figure 32. To adjust the zero point, press F4 (OK). The zero point is then adjusted. By pressing F3 (ABORT), the procedure is canceled and you are returned back to the Diag/Service menu.

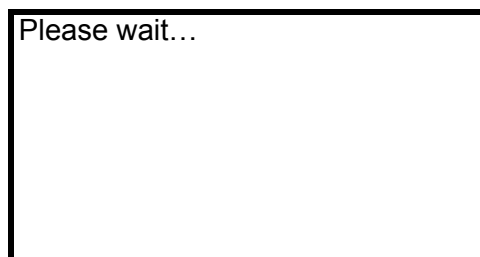

Figure 31 Please wait message

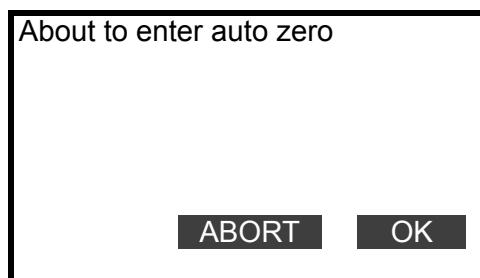

Figure 32 Zero point adjustment start message

5. While zero point adjustment is in progress, the screen remains unchanged. (Figure 33) If F3 (ABORT) is pressed here, zero point adjustment is canceled and you will

be returned to the Diag/Service menu. Once zero point adjustment is completed, the Diag/Service menu automatically is displayed.

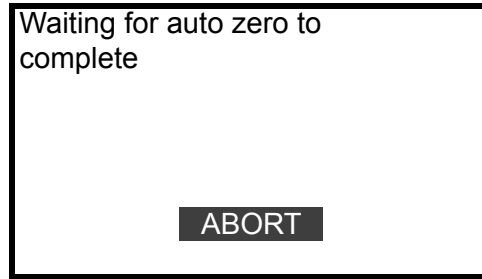

Figure 33 Zero point adjustment in progress message

6. If there was malfunction during zero point adjustment, a message stating that the applied process is too high will appear. (Figure 34) Select either "OK" or "ABORT" to return to the Diag/Service menu and verify that the flow fluid is completely static.

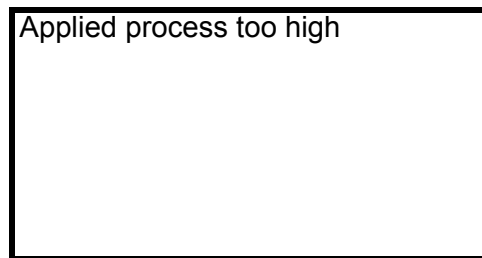

Figure 34 Zero point adjustment failure

2-2-2: 4 mA and 20 mA current output adjustment

During current output adjustment, the converter outputs current signals of either 0% or 100% of the flow range. If this affects the higher hierarchy control system, take measures so that the converter output is not sent to the control system. Actual measurement of current output is necessary for calibration. Proceed with the following steps to adjust the current output.

1. Select "3. D/A trim" from the Diag/Service menu. (Figure 30)
2. After a brief pause, a message 'WARN-Loop should be removed from automatic control' will appear. (Figure 35) If the control system is not affected by the forcible change of the current signal, press F4 (OK). Otherwise, press F4 (ABORT) to return to Diag/Service menu.

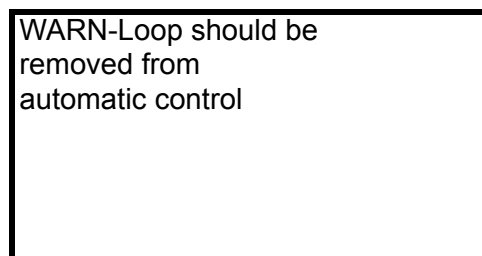

Figure 35 Warning for current adjustment

3. A message stating 'Connect reference meter' will then appear. (Figure 36) At this time, connect a meter to output terminals to measure the current and then press F4 (OK). To abort, press F3 (ABORT) and proceed on to step 11.

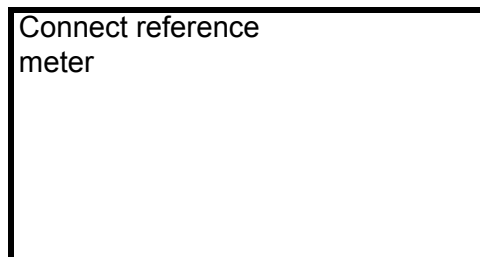

Figure 36 Message stating to connect meter

4. A message stating 'Setting fld dev to 4mA' will then appear. (Figure 37) By pressing F4 (OK), current adjustment will start and the converter will output a current corresponding to 0% of the flow range. To cancel, press F3 (ABORT) and proceed to step 11



Figure 37 Message to start current adjustment

5. By selecting F4 (OK) in the above step, the converter's indicator will flicker and _IN I.OUT OUTPUT MODE display will appear. The HART[®] Communicator displays on its screen the present current input value. (Figure 38) Measure the output current from the converter and enter it into the device. Once the input has been completed, press F4 (ENTER). To cancel, press F3 (ABORT) and proceed to step 10.

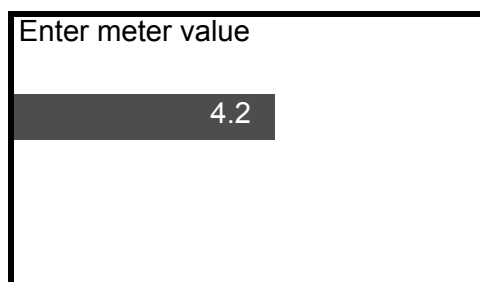

Figure 38 Current value input display

6. Press F4 (ENTER). The converter will start to accurately output 4mA based on the input value. The display as shown in Figure 39 will then appear. Measure the current manually and verify that it is 4mA. After this is verified, select "1. Yes" and proceed on to the next step. By choosing "2. No", the display of that shown in Fig-

ure 38 to show the current input will appear. Pressing F3 (ABORT) takes you back to the Diag/Service menu where you should proceed to step 10.

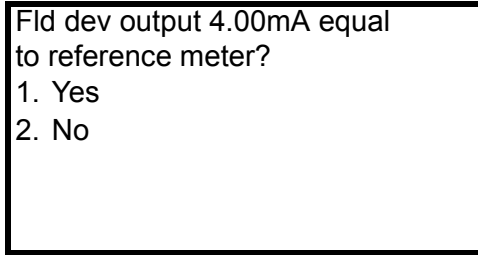

Figure 39 Verification of current output

7. Next a message stating 'Setting fld dev output to 20mA' will appear. (Figure 40) By pressing F4 (OK), current adjustment will start and the device will commence outputting a current corresponding to 100% of the flow. To cancel, press F3 (ABORT) and proceed on to step10.

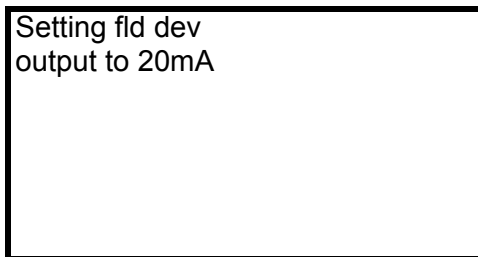

Figure 40 Message to start current adjustment

8. By selecting F4 (OK) in the above step, the converter's indicator will flicker and the _IN I.OUTPUT MODE display will appear. The HART[®] Communicator shows on the display the present current input value. (Figure 38) Measure the output current from the converter and enter this value into the device. Once this is completed, press F4 (ENTER). To cancel, press F3 (ABORT) and proceed to step10.

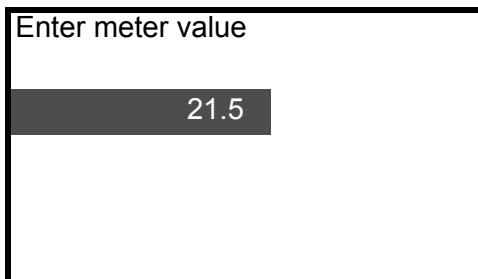
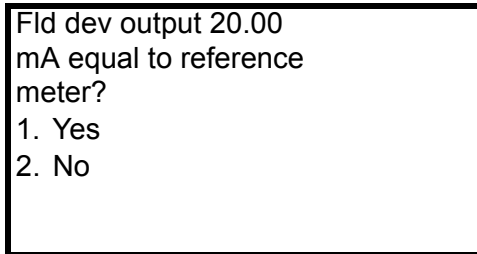

Figure 41 Current value input

9. By pressing F4 (ENTER), the converter will accurately output 20mA in reference to the input value. (Figure 42) Measure the current output and verify that it is 20mA. After this is verified, choose "1. Yes" and proceed on. By selecting "2.

No”, the current input display (Figure 41) will appear. Pressing F3 (ABORT) here returns you to the Diag/Service menu where you should proceed on to step10.



Fld dev output 20.00
mA equal to reference
meter?
1. Yes
2. No

Figure 42 Verification of current output

10. The converter transmits a forcible current output and the HART[®] Communicator's display will show a message stating 'returning fld dev to original output'. (Figure 43) This message will disappear automatically.



Returning fld dev to
original output

Figure 43 Forcible current output release message

11. A message stating 'NOTE-Loop may be returned to automatic control' will then appear. (Figure 44) If the converter has been disconnected, reconnect it now. If everything is acceptable, press F4 (OK). Adjustment work is now complete. The display returns to the Diag/Service menu.

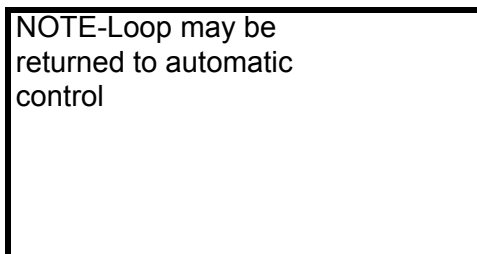

NOTE-Loop may be
returned to automatic
control

Figure 44 Message to urge connection between device and system

2-2-3: Pulse output check

Proceed with the following steps to check the pulse output.

1. Choose “4. Puls outp loop tst” from the Puls outp config menu. (Figure 22)
2. A message stating 'About to enter fixed freq. Mode test' as shown in Figure 45 will then appear. Press F4 (OK) to proceed. If F3 (ABORT) is pressed here, proceed on to step 7.

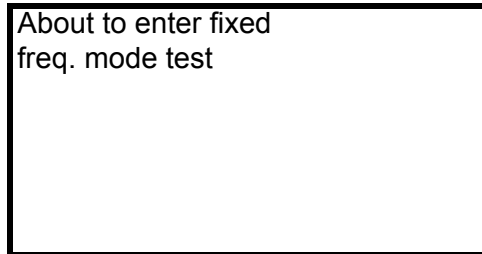

About to enter fixed
freq. mode test

Figure 45 Message to start pulse output check

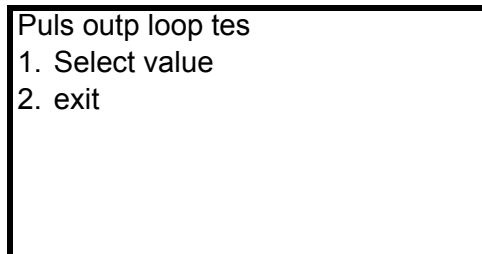

Puls outp loop tes
1. Select value
2. exit

Figure 46 Selection display for pulse output check

3. The display as that shown in Figure 46 will then appear. For pulse output inspection, select “1. Select value”. If “2. exit” is selected, the display is returned back to the original menu. If F3 (ABORT) is pressed here, proceed to step 7.
4. Next the numerical value input display will appear. (Figure 47) Here, a ratio for the flow range is input. A pulse corresponding to the input value will be then output. After the value has been entered, press F4 (ENTER). If F3 (ABORT) is pressed here, the display returns back to the menu where you should proceed on to step 7.
5. After F4 (ENTER) is pressed, a pulse corresponding to [(pulse span frequency) x (ratio as input in 4. above)] is forcibly output. The converter will show a flickering “_IN PULSE OUTPUT MODE” message. The HART[®] Communicator display returns to that shown in Figure 46 again. To change the output pulse, select “1. Select value” and reenter the numerical value. To finish, press “2.exit”.

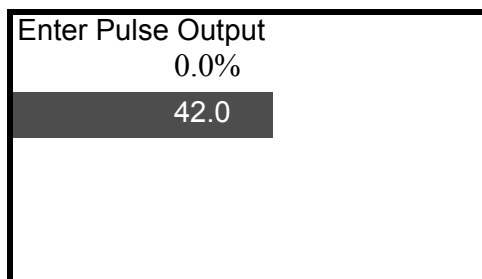

Enter Pulse Output
0.0%
42.0

Figure 47 Pulse output entry

6. If exit is selected, the HART[®] Communicator display will show a message stating 'Exiting pulse output mode'. (Figure 48) After a short while, a forcible pulse output is released and the display returns to the menu. If F3 (ABORT) is pressed here, the display returns to the menu where you should proceed to step 7.

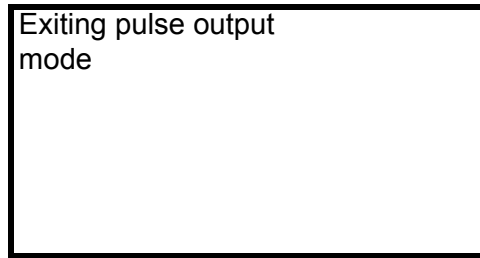

Figure 48 Forcible pulse output release message

7. If F3 (ABORT) is pressed, a message stating 'Warning Device may have Pulse frequency at a fixed value' will appear. (Figure 49) Verify that the pulse output corresponds to the flow output. This message automatically disappears after a short while and then the display will return to the menu.

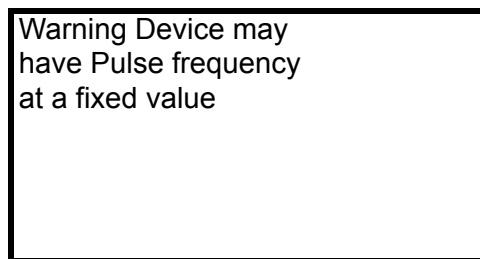

Figure 49 Forcible pulse output warning

3 : Other functions of HART[®] Communicator

The HART[®] Communicator not only facilitates output setting but also verifies the present status of the device. It also facilitates the setting of a tag number and other functions that are not directly related to the output. This chapter describes the HART[®] Communicator functions other than those related to output settings.

3-1: Settings not related to output

There are four settings that are not directly related to output. These are tag, descriptor, message and date. Follow the steps described below to set these.

1. Select “Device Info” from the detailed setup menu. (Figure 14)
2. The device info menu (Figure 50) shows you a list including tag, description, message and date. Select the one that you want to change. Figures for these are shown respectively in Figure 51 to Figure 54.

Device Info	
1.Distributor	
2.Tag	DD042
3.Descriptor	
4.Message	
↓ 5.Date	08/06/45

Figure 50 Device info menu

3. The date is written as month, day and year. The year can be entered as four digits. For years of the 1900's, only the last two digits are displayed and saved. For the 2000's, all four digits are displayed and saved.

Tags can also be changed from the basic setup menu.

Tag
DD042
FIC-0001

Figure 51 Setting the tag

Descriptor
DEV-420
LINE-2024

Figure 52 Setting the descriptor

Message
XXXXXXXXXXXXXXXXXXXXX
XXXXXXXXXXXX
FLUID WATER

Figure 53 Setting the message

Date
08/06/45
12/25/2000

Figure 54 Setting the date

3-2: Verifying the device status and other menus

The methods to verify the status and setting of the device and those other menus which have not been explained are described here.

3-2-1: Online

From the menu shown in Figure 3, present flow (PV), analog output (AO) and upper limit of range (URV) all can be verified. If these values are not completely displayed, the digits exceed the limit of display so use the right hand arrow key and the single item can be displayed for verification.

3-2-2: Process variables

By selecting “Process variables” from the device setup menu (Figure 8), a display as shown in Figure 55 will appear. This display allows you to verify the output of the device for ratio to range and in a flow unit.

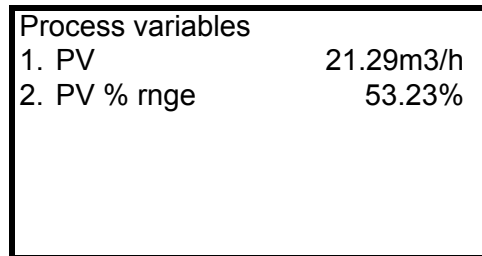

Process variables	
1. PV	21.29m3/h
2. PV % mng	53.23%

Figure 55 Process variables

3-2-3: Device status

By selecting “Device status” from the Diag/Service menu (Figure 30), a display as shown in Figure 56 will appear which enabling you to verify the present status of the device. Use F2 (PREV) or F3 (NEXT) to choose an item to verify.

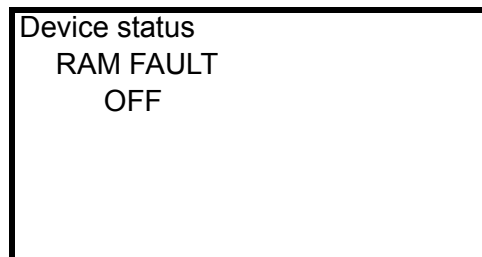

Device status	
RAM FAULT	OFF

Figure 56 Device status

The device is normal if the status of each item is OFF. If the status is listed as ON, normal measurement cannot be made. Verify the setting and status of the device. The items that are to be checked are as listed in Table 1. However, if there is any abnormality in the device, an error will be displayed as shown below.

If an error is transmitted to the HART[®] Communicator while the device status is being displayed, the HART[®] Communicator's will display a transmitted error as shown in Figure 57.

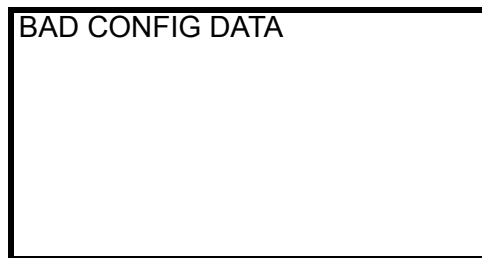

Figure 57 Error

By pressing F3 (NEXT), the transmitted error can be read. By pressing F2 (PREV), the previous error is displayed. Keep pressing F3 (NEXT) to view all the errors that occurred. The last display will be that as shown in Figure 58.

By pressing F1 (YES) here, up to fifty errors will be ignored and will not be sent to HART[®] Communicator. HART[®] Communicator's display will be as shown in Figure 56. Thus the condition of the device can be verified by using the device setup function until the 51st error is sent. However, once the 51st error has been transmitted, the display as shown in Figure 57 will pop up. Since an error experienced by the converter is always transmitted to the HART[®] Communicator, display shown in Figure 57 will reappear even if no action is taken in the display shown in Figure 56.

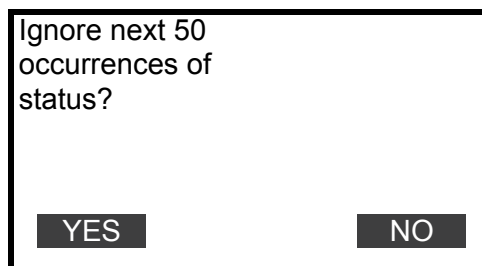

Figure 58 Inquiring to ignore error

If F2 (NO) is selected in Figure 58, the HART[®] Communicator's display will change to that shown in Figure 56. However, unless the device is set back into its normal condition, the display shown in Figure 57 will appear immediately upon the next error message from the converter.

Table 1 Items of device status

Item	Description
EXCCITE COIL FAULT	Faulty excitation by coil
A.C. POWER LOSS	Power supply failure
NVM fault	Faulty non-volatile memory
RAM FAULT	Faulty RAM
ROM FAULT	Faulty ROM
A/D FAULT	Faulty A/D converter
BAD CONFIG DATA	Existence of invalid data
DI/DO SATATUS	Contact output loop being checked
FIXED PULSE MODE	Pulse output being checked
OUTPUT MODE	Analog output being checked
LOCAL MODE	Setting being changed from display
CORRECT RESET	Unadjusted
EXCIT CHECK MODE	Exciting current being checked
EMPTY PIPE	Empty pipe detected
EXT ZERO ACTIVE	In zero adjustment mode
TYPE-DIA ERROR	Detector type and diameter incompatible
HIGH<LOW ERROR	Abnormal upper/lower limit alarms
SPAN OVER ERROR	Span exceeds 12m/s
PULSE WEIGHT ERROR	Frequency exceeds 200 Hz because of pulse weight, frequency is under 0.00006 Hz or different unit systems for range and pulse weights.
PULSE WIDTH ERROR	Duty ratio exceeds 70% because of pulse width
HYSTERISIS ERROR	Hysteresis exceeds 20%

3-2-4: Sensor Info

By selecting “1. Sensor info” from the sensor menu (Figure 15), the available upper limit of the setting range (PV USV), the lower limit (PV LSV) and the minimum span width of the range can be verified.

Sensor info	
1. PV LSL	0.00 m3/h
2. PV USL	54.29 m3/h
3. PV Min span	

Figure 59 Sensor info

3-2-5: Device info

As already described in section 3.1, settings that do not affect the output such as tag and others can be set from the device info menu (Figure 50). This menu also enables the user to verify such information as distributor, write protect, etc.

The value of write protect is YES only if the protect level is set at 3. For levels 0 to 2, it is NO.

3-2-6: Review

By selecting “Review” from the device setup menu (Figure 8), the condition of the device can be verified. Use F2 (PREV) to choose an item for verification. The items that can be verified are listed in Table 2.

Table 2 Review

Item	Description
Model	Model of device (MagneW)*
Distributor	Sales agent*
PV Unit	Unit of flow
PV URV	Upper limit of flow range
PV LRV	Lower limit of flow range (Fixed at 0m ³ /hr)
PV USV	Maximum value of range available for setting*
PV LSV	Minimum value of range for setting*
PV Min span	Minimum range width*
Xfer fctn	Transfer function of detector output to analog output
Lo flo cutoff	Low flow cut off
Flow tube size	Size of detector diameter
Puls scaling	Pulse weight
Puls width	Pulse width
PV Damp	Damping constant
AO Alrm type	Direction of abnormal alarm processing
Write protect	Write protect*
Manufacturer	Manufacturer*
Tag	Tag*
Descriptor	Descriptor*
Message	Message*
Date	Date*

* These values do not affect setting

4 : Table of HART® Communicator menus for Magnew3000 PLUS Series

Online Menu				
1. Device setup 2. PV 3. PV LRV 4. PV URV	1. Process variables	1. PV units 2. PV% range		
	2. Diag/Service	1. Device status 2. Auto zero 3. D/A trim		
	3. Basic setup	1. Tag 2. PV unit 3. PV URV 4. PV LRV 5. PV Damp		
	4. Detailed setup	1. Sensor	1. Sensor info	1. PV LSV 2. PV USV 3. PV Min span
			2. Sensor Config	1. Flow tube size 2. EX_factor 3. Lo flo cutoff
2. Totalizer		1. Puls outp config	1. Puls out unit 2. Puls scaling 3. Puls width 4. Puls outp loop tes	
	3. Device Info	1. Distributor 2. Tag 3. Descriptor 4. Message 5. Date 7. Write protect		
	5. Review			

Document Number:	CM2-MGG21H-2001
Document Name:	MagneW3000 PLUS HART [®] Communicator User's Manual
Date:	1st edition: Jan. 2004 2nd edition: Aug. 2012
Issued/Edited by:	Azbil Corporation

Azbil Corporation