

# AC/DC2-wire Type Cylindrical Proximity Switches

**FL7M Series**

No-polarity 2-wire general-purpose switches are easy to use.

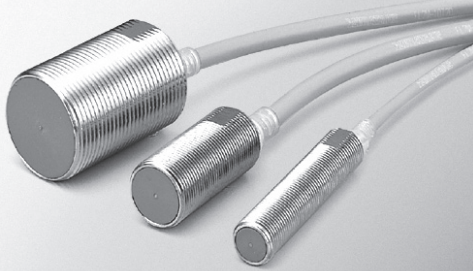

- 2-wire type for both AC and DC greatly reduces wiring man-hours
- Stable sensing area displayed by setting indicator (green/red LED)
- Indicator lamp can be seen even from the rear (pre-leaded and pre-leaded connector types)
- Compact and space-saving
- Sealed to IP67
- Enhanced circuit protection (surge absorption, load short-circuit)

## ORDER GUIDE

### ● Standard (pre-leaded) type (2 m cable)

| Exterior | Sensing distance |      | Operation mode | Setting indicator | Catalog listing |
|----------|------------------|------|----------------|-------------------|-----------------|
|          | M12              | 3mm  | N.O.           | ○                 | FL7M-3T7HD      |
|          | M18              | 7mm  | N.O.           | ○                 | FL7M-7T7HD      |
|          | M30              | 10mm | N.O.           | ○                 | FL7M-10T7D      |

### ● Connector type

| Exterior | Sensing distance |      | Operation mode | Setting indicator | Catalog listing |
|----------|------------------|------|----------------|-------------------|-----------------|
|          | M12              | 3mm  | N.O.           | ○                 | FL7M-3T7HD-CN   |
|          | M18              | 7mm  | N.O.           | ○                 | FL7M-7T7HD-CN   |
|          | M30              | 10mm | N.O.           | ○                 | FL7M-10T7D-CN   |

### ● Pre-leaded connector type (30 cm cable)

| Exterior | Sensing distance |      | Operation mode | Setting indicator | Catalog listing |
|----------|------------------|------|----------------|-------------------|-----------------|
|          | M12              | 3mm  | N.O.           | ○                 | FL7M-3T7HD-CN03 |
|          | M18              | 7mm  | N.O.           | ○                 | FL7M-7T7HD-CN03 |
|          | M30              | 10mm | N.O.           | ○                 | FL7M-10T7D-CN03 |

### ● Accessories (sold separately)

| Name                             | Appearance | O.D.    | Catalog listing |
|----------------------------------|------------|---------|-----------------|
| Mounting bracket                 |            | For M12 | FL-PA112        |
|                                  |            | For M18 | FL-PA118        |
|                                  |            | For M30 | FL-PA130        |
| Protective cover                 |            | For M12 | FL-PA12         |
|                                  |            | For M18 | FL-PA18         |
|                                  |            | For M30 | FL-PA30         |
| Spatter-guarded protective cover |            | For M08 | FL-PA08W        |
|                                  |            | For M12 | FL-PA12W        |
|                                  |            | For M18 | FL-PA18W        |
|                                  |            | For M30 | FL-PA30W        |

## SPECIFICATIONS

| Catalog listing                |                            | FL7M-3T7HD(-CN,-CN03)  | FL7M-7T7HD(-CN,-CN03)  | FL7M-10T7D(-CN,-CN03)   |
|--------------------------------|----------------------------|--|--|---|
| Actuation method               |                            | High-frequency oscillation type (shielded)   |  |   |
| Rated sensing distance         |                            | 3±0.3mm  | 7±0.7mm  | 10±1 mm   |
| Usable sensing distance        |                            | 0 to 2.1 mm  | 0 to 4.9 mm  | 0 to 7 mm   |
| Standard target object         |                            | 12 × 12mm, 1mm thick iron  | 18 × 18mm, 1mm thick iron  | 30 × 30mm, 1mm thick iron   |
| Differential travel            |                            | 10% max. of sensing distance   |  |   |
| Rated supply voltage           |                            | 100/200Vac, 50/60Hz 24Vdc  |  |   |
| Operating voltage range        |                            | 40 to 250 Vac, 20 to 250 Vdc   |  |   |
| Leakage current                |                            | When AC power supply is used: 2.0mA max. (100/200Vac), When DC power supply is used: 1.1mA max. (24Vdc)  |  |   |
| Control output                 |                            | Switching current: 5 to 100mA (at 30Vdc supply voltage: 5 to 20mA)<br>Voltage drop: When AC power supply is used 10V max., When DC power supply is used 6V max.<br>Output dielectric strength: 250V (at both AC and DC power supplies) |  |   |
| Operating frequency            |                            | When AC power supply is used 25Hz<br>When DC power supply is used 1 KHz  | When AC power supply is used 25Hz<br>When DC power supply is used 500 Hz | When AC power supply is used 25Hz<br>When DC power supply is used 400Hz |
| Temperature characteristics    |                            | ±10% max. for the range of -25 to +70°C when +25°C is taken as standard temperature in sensing distance.   |  | -10 to +60°C  |
| Supply voltage characteristics |                            | ±1% max. with +15% voltage fluctuation with rated supply voltage as standard voltage in sensing distance   |  |   |
| Indicator lamps                |                            | Operation indication: Lights (red or green) at output<br>Setting indication: Lights (green) in stable sensing area   |  |   |
| Operating temperature range    |                            | -25 to +70°C   |  | -10 to +60°C  |
| Insulation resistance          |                            | 50MΩ min. (at 500Vdc)  |  |   |
| Dielectric strength            |                            | 4,000 Vac, 50/60 Hz for 1 minute   |  |   |
| Vibration resistance           |                            | 10 to 55Hz, 1.5mm peak-to-peak amplitude, 2 hrs in X, Y and Z directions   |  |   |
| Shock resistance               |                            | 980 m/s <sup>2</sup> 10 time in X, Y and Z directions  |  |   |
| Protection                     |                            | IP67 (IEC standard), IP67G (JEM standard)  |  |   |
| Weight                         | Standard (pre-leaded type) | Approx. 90 g<br>Main unit with 2 m pre-leaded cable  | Approx. 160 g<br>Main unit with 2 m pre-leaded cable                     | Approx. 270 g<br>Main unit with 2 m pre-leaded cable                    |
|                                | Circuit protection         | Surge absorption, load short-circuit protection (at 20 to 40Vdc)   |  |   |
| Wiring method                  |                            | Connector, pre-leaded connector, pre-leaded  |  |   |
| Material                       | Switch                     | Case<br>Ni-plated brass  |  |   |
|                                | Connector                  | Sensing face<br>PBT  |  |   |
|                                |                            | Housing<br>-CN:Ni-plated Zn, -CN03:polyester elastomer   |  |   |
|                                |                            | Holder<br>PBT  |  |   |
|                                |                            | Contact<br>-CN:Sn-plated brass, -CN03:Gold-plated brass  |  |   |

## ABOUT SETTING INDICATION

The proximity switch can detect objects reliably by bringing the proximity switch close to the target object and setting the switch at the position where the indicator lamp changes from red to green.

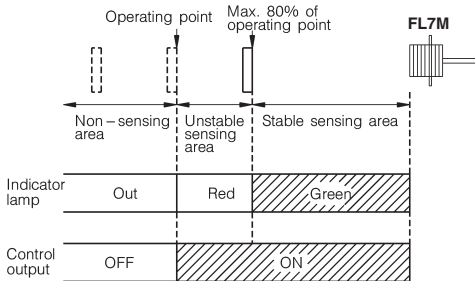

**Note:** When the target object is made of a different material such as aluminum, copper and stainless steel to the standard target object (iron), the setup point where the indicator lamp changes color is shorter than 80% maximum.

## SENSING AREA (typical)

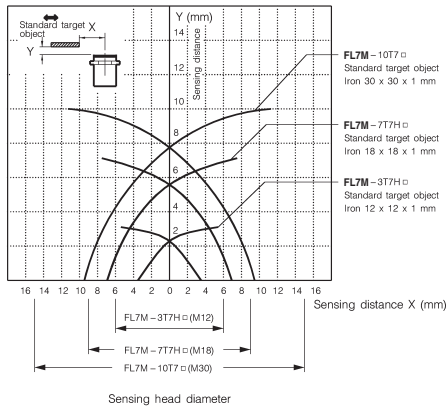

## SENSING DISTANCE ACCORDING TO MATERIAL & SIZE OF OBJECT (typical)

### ● FL7M-3T7H □

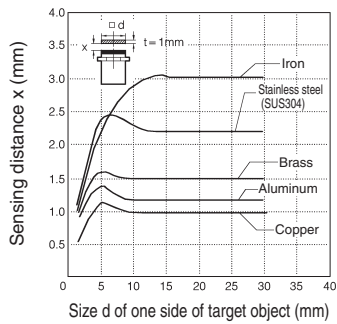

### ● FL7M-7T7H □

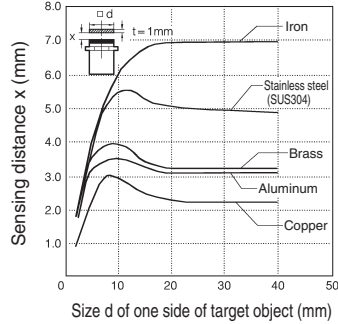

### ● FL7M-10T7 □

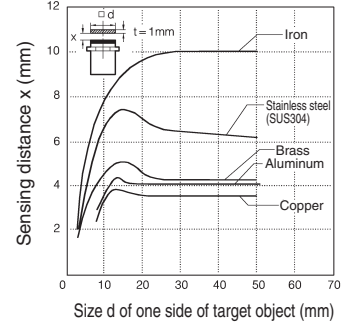

## VOLTAGE DROP (typical)

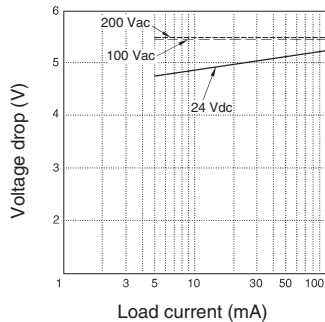

## LEAKAGE CURRENT (typical)

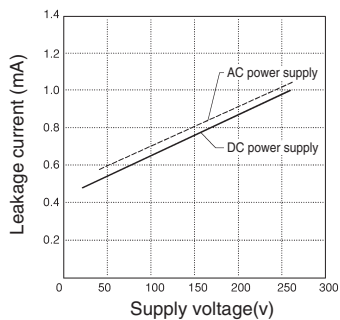

# EXTERNAL DIMENSIONS

(unit: mm)

## Standard (prelead) type

### FL7M-3T7HD

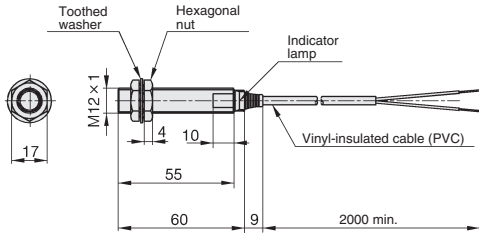

Vinyl-insulated cable (oil-resistant: 0.3 mm<sup>2</sup>, 60/0.08 dia., 2-core) dia. 4. Cap color: orange.

### FL7M-7T7HD

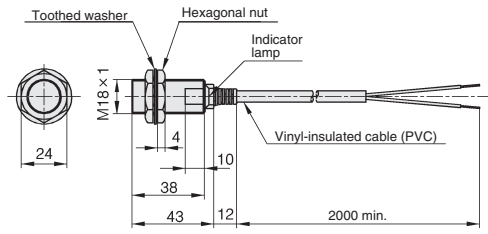

Vinyl-insulated cable (oil-resistant: 0.5 mm<sup>2</sup>, 45/0.12 dia., 2-core) dia. 6. Cap color: orange.

### FL7M-10T7D

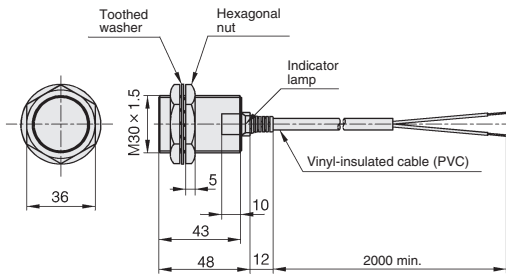

Vinyl-insulated cable (oil-resistant: 0.5 mm<sup>2</sup>, 45/0.12 dia., 2-core) dia. 6. Cap color: orange.

## Connector type

### FL7M-3T7H□-CN

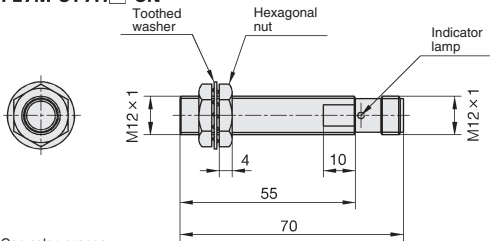

Cap color: orange.

### FL7M-7T7H□-CN

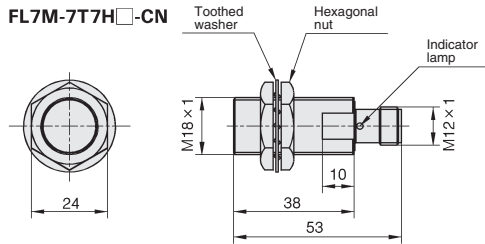

Cap color: orange.

### FL7M-10T7□-CN

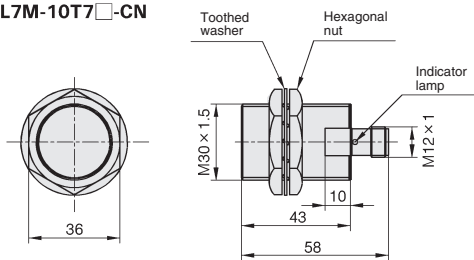

Cap color: orange.

Note:

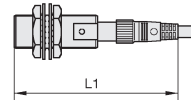

When using a straight-type connector, dimension L1 is the overall length plus about 30 mm.

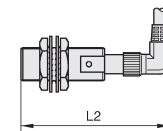

When using an angled connector, dimension L2 is the overall length plus 20 mm.

## ● Prelead connector type

### FL7M-3T7H□-CN03

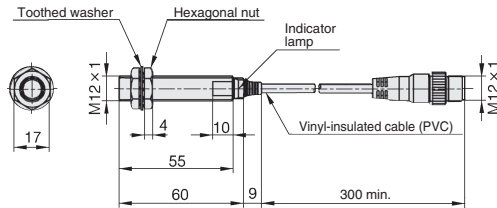

Vinyl-insulated cable (oil-resistant: 0.3 mm<sup>2</sup>, 60/0.08 dia., 2-core)  
dia. 4. Cap color: orange.

### FL7M-10T7□-CN03

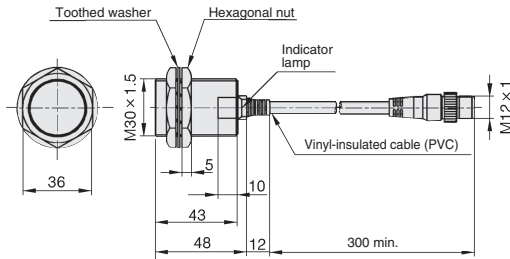

Vinyl-insulated cable (oil-resistant: 0.5 mm<sup>2</sup>, 45/0.12 dia., 2-core)  
dia. 6. Cap color: orange.

### FL7M-7T7H□-CN03

(unit: mm)

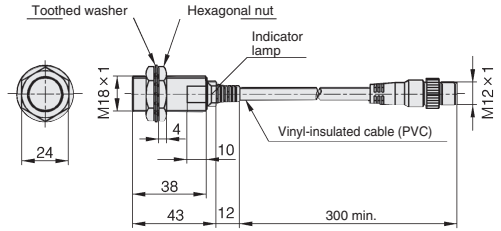

Vinyl-insulated cable (oil-resistant: 0.5 mm<sup>2</sup>, 45/0.12 dia., 2-core)  
dia. 6. Cap color: orange.

## ■ MOUNTING BRACKET (sold separately)

Mounting brackets are made of polyacetal resin.  
Two screws and two washers are provided for each bracket.

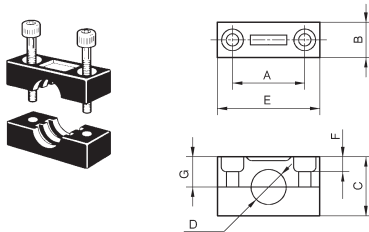

FL-PA118 and FL-PA130 screw holes are oblong.

| Catalog listing | Dimensions (mm) |    |    |        |    |     |      | Screw size |      |
|-----------------|-----------------|----|----|--------|----|-----|------|------------|------|
|                 | A               | B  | C  | D      | E  | F   | G    | Dia.       | Neck |
| FL-PA112        | 25              | 12 | 20 | 12dia. | 36 | 6   | 9.5  | M4         | 25   |
| FL-PA118        | 30/32           | 15 | 30 | 18dia. | 45 | 7.5 | 14.5 | M5         | 35   |
| FL-PA130        | 40/45           | 15 | 50 | 30dia. | 60 | 10  | 24.5 | M5         | 55   |

### Allowable tightening torque of bracket screws

| Catalog listing | Max. torque (N·m) |
|-----------------|-------------------|
| FL-PA112        | 0.98              |
| FL-PA118        | 1.5               |
| FL-PA130        | 1.5               |

## ■ PROTECTIVE COVER (sold separately)

Protective covers made of polyacetal resin are available for shielded models. Select a model according to the switch's external dimensions.

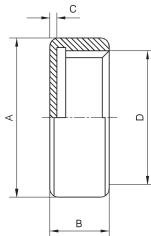

| Catalog listing | Dimensions (mm) |   |     |         |
|-----------------|-----------------|---|-----|---------|
|                 | A               | B | C   | D       |
| FL-PA12         | 14dia.          | 5 | 0.5 | M12x1   |
| FL-PA18         | 21dia.          | 6 | 0.5 | M18x1   |
| FL-PA30         | 33dia.          | 8 | 1.5 | M30x1.5 |

## ■ SPATTER-GUARDED PROTECTIVE COVER (sold separately)

Spatter-guarded protective covers made of fluorine resin and designed especially for shielded switches are available. Select a model according to the switch's external dimensions.

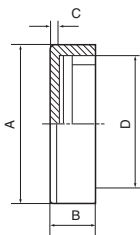

| Catalog listing | Dimensions (mm) |   |     |         |
|-----------------|-----------------|---|-----|---------|
|                 | A               | B | C   | D       |
| FL-PA08W        | 10dia.          | 5 | 0.5 | M8x1    |
| FL-PA12W        | 15dia.          | 5 | 0.7 | M12x1   |
| FL-PA18W        | 22dia.          | 6 | 0.7 | M18x1   |
| FL-PA30W        | 34dia.          | 8 | 1.5 | M30x1.5 |

## WIRING DIAGRAMS

### Preleaded type

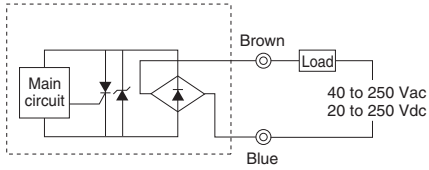

### Preleaded connector type

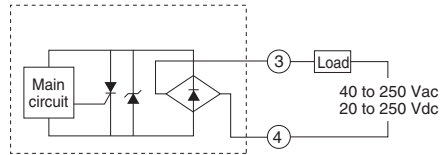

- The load may be connected to either pole.
- The LED operates normally during a load short circuit, so check the wiring if the output is wrong.
- Fasten connectors tightly by hand.

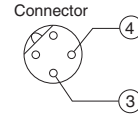

## CONNECTOR SPECIFICATIONS<sup>1</sup>

| Item                            | Specifications   |
|---------------------------------|--|
| Insulation resistance           | Max. 100 M $\Omega$ (by 500 Vdc megger)  |
| Dielectric strength             | 1,500 Vac for 1 minute (between contacts, and between contact and connector housing)   |
| Initial contact resistance      | Max. 40 m $\Omega$ (with 3A current to connected male and female connectors. Semiconductor lead-specific resistance not included.)           |
| Mating/unmating force           | 0.4 to 4.0 N per contact   |
| Mating cycles                   | 50   |
| Connector nut tightening torque | Min. 0.8 N·m *2  |
| Cable pullout strength          | Min. 100 N   |
| Vibration resistance            | 10 to 55 Hz, 1.5 mm peak-to-peak amplitude, for 2 hours each in X, Y and Z directions  |
| Impact resistance               | 300 m/s <sup>2</sup> , 3 times each in X, Y and Z directions   |
| Protective structure            | IP67   |
| Ambient operating temperature   | -10 to +70°C   |
| Ambient storage temperature     | -20 to +80°C   |
| Ambient operating humidity      | Max. 95% RH  |
| Material Contacts:              | Gold-plated brass<br>Contact holder: Glass-lined polyester resin<br>Housing: Polyester elastomer<br>Coupling: Ni-plated brass<br>O-ring: NBR |



Note 1: Specifications assume Azbil male/female connectors.

Note 2: The recommended torque is 0.4 to 0.6 N·m. If fastened poorly, the IP67 protection is lost, or looseness occurs. Fasten the connector securely by hand.

## CABLE WITH CONNECTOR

Be sure to use a PA5 Series connector with cable when connecting a preleaded connector or connector-type switch.

### ● PA5 Series connector with cable

| Shape   | Power supply | Cord properties  | Cord length | Catalog listing | Lead colors                           |
|---|--------------|--|-------------|-----------------|---------------------------------------|
|  | DC           | Vinyl-insulated cord with high resistance to oil and vibration (UL/NFPA79 CM, CL3) | 2 m         | PA5-4J SX2SK    | 1: brown, 2: white, 3: blue, 4: black |
|   |              |  | 5 m         | PA5-4J SX5SK    | 1: brown, 2: white, 3: blue, 4: black |
|  |              |  | 2 m         | PA5-4J LX2SK    | 1: brown, 2: white, 3: blue, 4: black |
|   |              |  | 5 m         | PA5-4J LX5SK    | 1: brown, 2: white, 3: blue, 4: black |

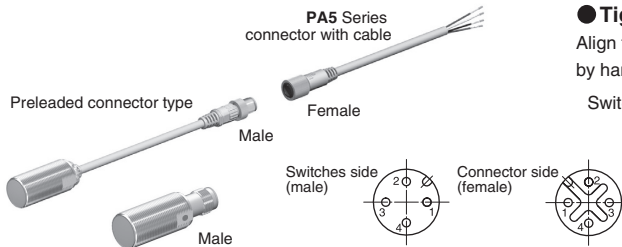

### ● Tightening the connector

Align the grooves and rotate the fastening nut on the PA5 connector by hand until it fits tightly with the connector on the switches side.

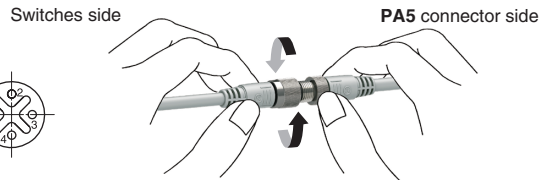

## PRECAUTIONS FOR USE

### 1. Mounting

| Catalog listing | Max. tightening torque (N·m) |
|-----------------|------------------------------|
| FL7M-3T7H□      | 20                           |
| FL7M-7T7H□      | 70                           |
| FL7M-10T7□      | 180                          |

Note: The table shows the allowable tightening torque when toothed washers (provided) are used.

The allowable tightening torque varies depending on the materials and surface conditions of the mounting plates, mounting housings, nuts, washers and other parts used for the switch. Check that the torque is appropriate for the actual combination of parts used before putting the switch into operation.

### 2. Influence of surrounding metal

Metal other than the target object surrounding the switch may influence operating characteristics. Leave space between the switch and surrounding metal as shown below. Shaded areas indicate surrounding metal other than the target object.

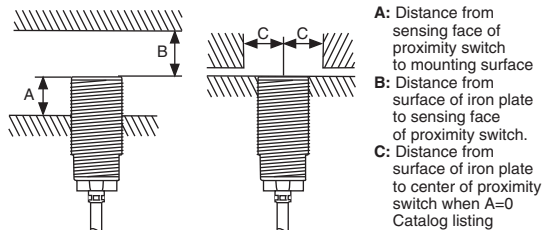

| Catalog listing | A(mm) | B(mm) | C(mm) |
|-----------------|-------|-------|-------|
| FL7M-3T7H□      | 0     | 8     | 9     |
| FL7M-7T7H□      | 0     | 20    | 13.5  |
| FL7M-10T7□      | 0     | 40    | 22.5  |

### 3. Mutual interference prevention

When mounting proximity switches either parallel to or facing each other, mutual interference may cause the switch to malfunction. Maintain at least the distances indicated in the figures below.

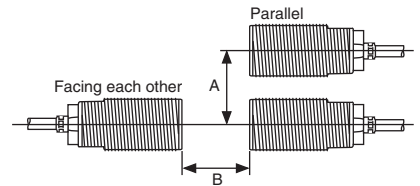

| Catalog listing | A(mm) | B(mm) |
|-----------------|-------|-------|
| FL7M-3T7H□      | 20    | 30    |
| FL7M-7T7H□      | 35    | 50    |
| FL7M-10T7□      | 70    | 100   |

## 4. Cautions for series or parallel connection

### 4.1 Series connection (AND switching circuit)

In case of either 100 Vac or 200 Vac, the voltage which is applied to the load in the ON condition is  $V_L = V_S - (\text{output voltage drop} \times \text{number of units}) (V)$ . Note that the load will not be activated unless  $V_L$  is more than the minimum activating voltage of the load.

When more than 2 units are connected in series and are used in an AND switching circuit, the maximum number of units is 3. (Pay attention to the  $V_S$  value shown in the figure below.)

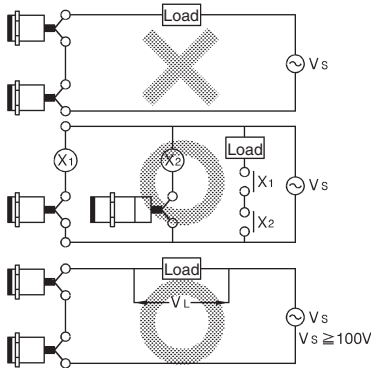

### 4.2 Parallel connection (OR switching circuit)

In principle it is not possible to use more than 2 proximity switches in parallel as an OR switching circuit. A parallel connection can be used only if A and B do not operate at the same time and if it is not necessary to hold the load. However, consumption current (leakage current) will be multiplied by  $n$  (the number of proximity switches), and recovery failure will occur more easily.

If A and B operate at the same time and if it is necessary to retain the load, a parallel connection cannot be used. Under these conditions, when A is turned ON, the voltage at both ends of A and B drops to approx. 10V, allowing load current to flow through A. When a target object approaches B, the switching element of B cannot be activated because the voltage at both ends of B is too low. When A is again turned OFF, the voltage at both ends of A and B increases to the power supply voltage, and at this point B can be turned ON for the first time.

During this time, since there is a period (approx. 10 ms) when both A and B are OFF, the load is momentarily reset. In order to retain the load, use a relay as shown below.

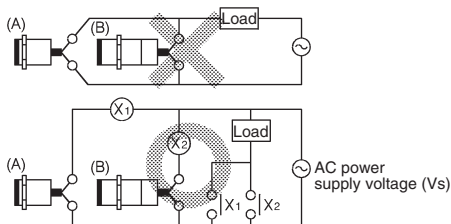

Before use, thoroughly read the "Precautions for use" and "Precautions for handling" in the Technical Guide on pages C-107 to C-113 as well as the instruction manual and product specification for this switch.

## 5. Loads that cause inrush current

When the proximity switch is connected to a load such as an electromagnetic switch, lamp or motor that causes inrush current, use the switch within the rated current, which includes the inrush current.

## 6. Connection to power supply and load

Be sure to connect the proximity switch to the power supply via the load. If the switch is connected directly to the power supply, the switch will be damaged. Also, output does not have polarity, so the load can be connected to either side of the power supply. However, we recommend connecting the load to the non-grounded side to prevent short-circuiting of the power supply if a ground fault caused by damage to the proximity switch occurs.

## 7. Operation upon power ON

After the power is turned ON, it takes at most 80 ms until the proximity switch is ready for sensing. If the load and the proximity switch use different power supplies, be sure to turn the proximity switch ON before turning the load ON.

## 8. Influence of leakage current

A minimal current flows as leakage current for operating the circuits even when the proximity switch is OFF. Keep this in mind when turning off connected loads.

## 9. Minimum cable bend radius (R)

The minimum bend radius (R) of the cable is 3 times the cable diameter. Take care not to bend the cable beyond this radius. Also, do not excessively bend the cable within 30 mm of the cable lead-in port.