

azbil

Multi Loop Controller SDC45A/46A



*High-speed, high-accuracy and high-performance
next-generation controllers.*



Please, read 'Terms and Conditions' from following URL before the order and use.

<http://www.azbil.com/products/factory/order.html>

SDC is a registered trademark of Azbil Corporation In Japan.
Other product names, model numbers and company names may be trademarks of the respective company.

[Notice] Specifications are subject to change without notice.
No part of this publication may be reproduced or duplicated
without the prior written permission of Azbil Corporation.

Azbil Corporation
Advanced Automation Company

Yamatake Corporation changed its name to Azbil Corporation on April 1, 2012.

1-12-2 Kawana, Fujisawa
Kanagawa 251-8522 Japan

URL: <http://www.azbil.com>

1st Edition : Issued in Mar. 2007-BR
6th Edition: Issued in Sep. 2017-AZ

EvolutionStyle

The capabilities you expect from a high-end model – these controllers offer highly advanced functionality.

High speed (25ms), high accuracy ($\pm 0.1\%$ rdg) and a new algorithm.
Full multi-range input for 2 loops opens new vistas for control.



Models with all-orange LEDs are available.
Orange LEDs have superior visibility in outdoor applications.

(Models in photo show all displayable digits, not an actual display.)

A generous variety of I/O, to satisfy high-level control demands.

● Suitable for multiple application requirements ●

Available control modes

PID, heat/cool, 2-loop PID, and cascade control

PV1 input

Full multi-range

PV2 input (optional)

Full multi-range (also applicable as RSP)

Digital inputs (optional)

Up to 14 digital inputs can be used to change modes or settings.

Communications (optional)

RS-485 (3-wire system)

Output

A wide variety is available, including current, voltage and relay. Up to 7 can be selected (SDC46A).

Heat/cool function

Two outputs are used for heat/cool control.

Digital outputs (optional)

Up to 8 DOs are available, including various event and device status outputs.

PC compatible

Configure and monitor on a PC using the Smart Loader Package.



Illustration shows the SDC46A.

Hardware

Thoughtful design responding to a variety of needs

Full multi-range input

Both inputs of the 2-input model are full multi-range. This versatile model is suitable for use with temperature sensors, signal transmitters, PH meters, and various linear signal applications. Customization is available on request, for applications such as signal for RS, 2-loop PID control, and cascade control.

Power supply can be installed for signal transmitter (optional).

Up to two 24Vdc 30mA power supplies can be installed (one for the SDC45A). An external power supply is not required, allowing simple wiring for use with signal transmitter, etc.

IP65 front panel protection

If the included gasket is used, the front panel has IP65 splash-proof protection. This allows the controller to be used for food manufacturing processes, etc.



Easy-to-operate keys

All necessary keys are arranged for easy setting and operation. Mechanical keys click when used, enhancing usability.



Software

Enhanced software for advanced hardware

Configure and monitor from a PC

The SDC45A/46A can connect to a PC via the Smart Loader Package (SLP), which includes a dedicated connector cable. The SLP software allows parameter setting, trend monitoring, and data output as CSV files.



Easy data logging function

The communications function of the SDC45A/46A allows data logging of multiple controllers using the Smart Loader Package. DI/DO status can be logged simultaneously.

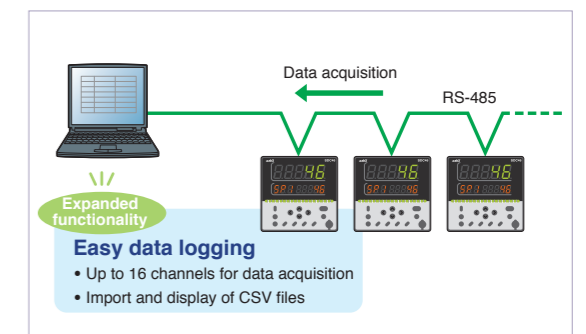

Event configuration functionality means less wiring, reduced labor costs

The SDC45A/46A provides 16 internal event settings, which can be assigned to relay output or DO. A robust event output function reduces wiring and labor costs and increases flexibility when expanding instrumentation.

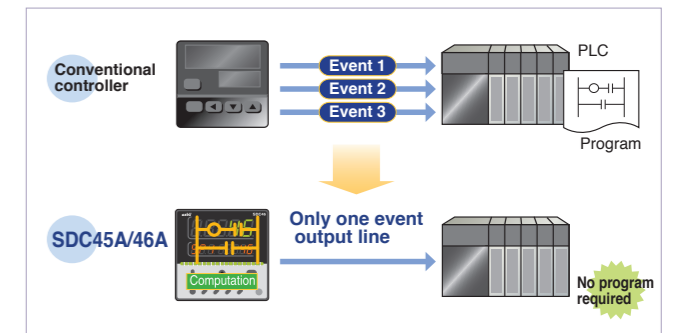

Monitoring & Operation

Easy to see, easy to operate

High-intensity LEDs for viewing ease

High-intensity LEDs are used for 7-segment dual displays and 11-segment auxiliary display, ensuring clear visibility. All-orange LED models are also available, offering markedly improved outdoor visibility.



Mode keys designed for usability

Mode keys are arranged for easy use. Keys (auto/manual, remote SP/local SP, AT start, etc.) can be changed with a single action. User-assignable function keys can be used for function changeover or recall of up to 8 parameters.



Control

Broad application support includes nonlinear processes

I/O linearization table is a standard feature

Features a 20-point linearization table for use just after input processing and just before control output processing.

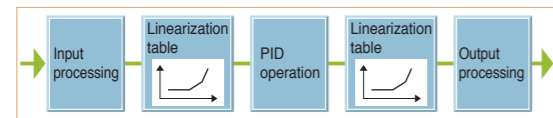

Fixed output level function

For equipment startup or in the initial processing stage, constant control output on a temporary basis is available for purposes of equipment protection or control stabilization. Up to 8 set points can be set, allowing flexibility for a variety of application needs.

Heat/cool control

Up to 7 outputs are available to handle a wide variety of heat/cool control requirements.

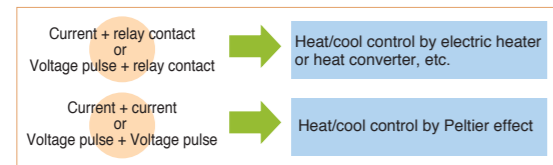

New algorithms for enhanced control

Stable control that is unaffected by disturbances is accomplished using highly accurate Ra-PID (RationalLoop PID) control logic and the Just-FITTER algorithm for overshoot suppression.

3 types of auto-tuning (AT) are standard features

The SDC45A/46A is equipped with:

- Regular AT
- Quick-response AT, optimal for systems that heat up easily
- Stable operation AT, optimal for systems that heat up and cool down easily

Cascade control (2-input model)

PID cascade control can be done using only one controller acting as both master and slave. This is very effective for a process with a large dead time. When using 2 units for cascade control, the control mode can be easily switched (cascade control ↔ slave control only).

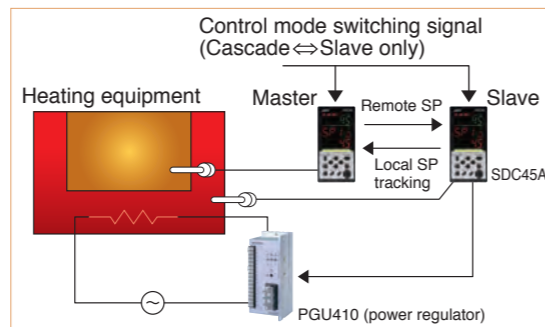
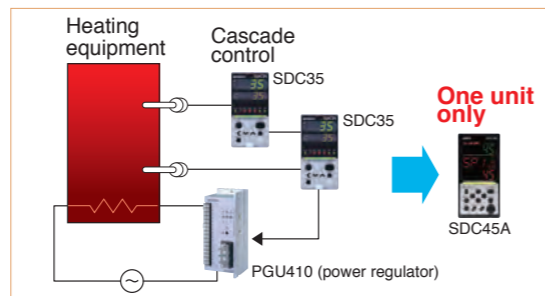

Backup controller (2-input model)

When control is handled by another device such as DCS, and is interrupted due to power failure or malfunction, bumpless transfer to a controller can be initiated by a preset value or tracking of the other device's output.

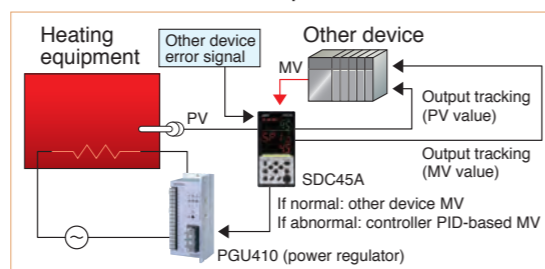

Specifications

PV input	Type	Thermocouple, RTD, DC current, DC voltage	
	Range	(Refer to Input Type and Range table)	
	Sampling cycle	25 ms, 50 ms, 100 ms, 300 ms (depending on setup)	
Indication	Method	Digital 5-digit, 7-segment and 3-digit, 11-segment	
	Accuracy	±0.1 % rdg ±1 digit (depending on range)	
Output	No. of outputs	SDC45A: 5 max., SDC46A: 7 max.	
	Type	Relay, voltage pulse, DC current and voltage, triac (for position proportional output), power supply for signal transmitter (24 Vdc)	
	Control mode	PID	
	No. of PID groups	16	
	Auto-tuning	Automatic PID settings by limit cycle method	
DI	No. of inputs	SDC45A: 10 max., SDC46A: 14 max.	
	Function	LSP No., READY/RUN changeover, etc.	
DO (transistor)	No. of outputs	8 max.	
	Function	PV, SP, deviation value, device alarm, etc.	
Communications	Type	RS-485	
	No. of connected units	31 max.	
	Speed	38400 bps max.	
General	Power	AC power model : 100 to 240 Vac 50/60 Hz , DC power model : 24 Vdc	
	Power consumption	SDC45A: 30 VA max.(AC power model) , 12 W max (DC power model) SDC46A: 40 VA max.(AC power model) , 15 W max (DC power model)	
	Certification	CE marking (EN61010-1, EN61326), cUL (UL61010-1)*	
	Front panel protection	IP65	
	Mass	SDC45A: 400 g max. SDC46A: 700 g max. (including dedicated mounting parts)	

*. Varies depending on the model.

Input Type and Range

Sensor	Sensor type	Range (C)	Range (F)	
Thermocouple	K	-270.0 to +1372.0	-454 to +2502	
	E	-270.0 to +1000.0	-454 to +1832	
	J	-200.0 to +1200.0	-328 to +2192	
	T	-270.0 to +400.0	-454 to +752	
	B	0.0 to 1800.0	32 to 3272	
	R	-50.0 to +1768.0	-58 to +3214	
	S	-50.0 to +1768.0	-58 to +3214	
	WR5-26	0.0 to 2300.0	32 to 4172	
	PR40-20	0.0 to 1900.0	32 to 3452	
	Ni-Mo-Ni	0.0 to 1300.0	32 to 2372	
	N	-200.0 to +1300.0	-328 to +2372	
	PL II	0.0 to 1390.0	32 to 2534	
RTD	Pt100	-200.0 to +850.0	-328.0 to +1562.0	
		-200.00 to +300.00	-328.00 to +572.00	
		-200.0 to +640.0	-328.0 to +1184.0	
	JPt100	-200.00 to +300.00	-328.00 to +572.00	
		DC current / voltage		
		Current	4 to 20 mA	
		Voltage	0 to 20 mA	
		0 to 10 mV		
		-10 to +10 mV		
		0 to 100 mV		
		-100 to +100 mV		
		0 to 1 V		
		-1 to +1 V		
		1 to 5 V		
		0 to 5 V		
		0 to 10 V		

Input sensor standards

- Thermocouple K, J, E, T, R, S, B, N: JIS C 1602-1995
- PL II: ASTM E1751-00
- WR5-26: ASTM E988-96 (reapproved 2002)
- Ni-Mo-Ni: ASTM E1751-00
- PR40-20: ASTM E1751-00
- DIN U, DIN L: DIN 43710-1985
- Gold-iron/Chromel: ASTM E1751-00
- RTD Pt100: JIS C 1604-1997
- JPt100: JIS C 1604-1989

Dimensions

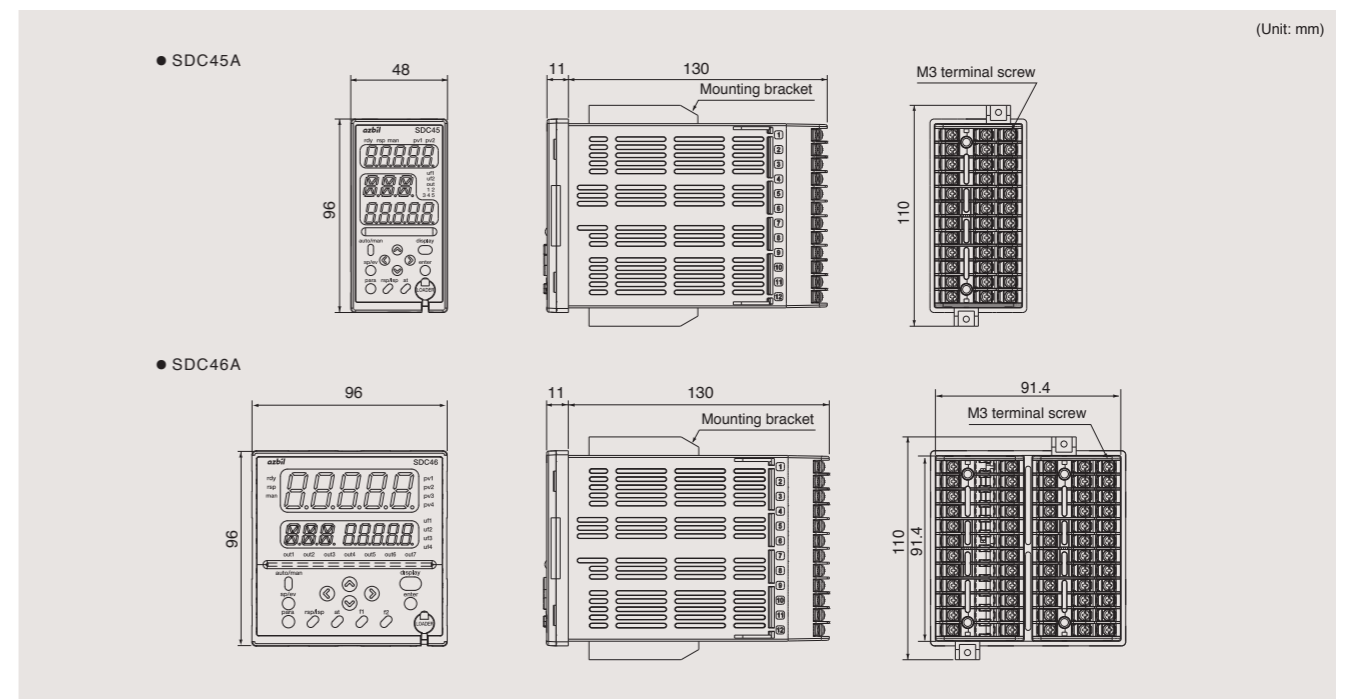

Selection Guide

Model No. selection methods

- **Detailed model No.** / Specifications required for a particular application can be selected in detail, allowing purchase of the optimal device (especially useful for equipment manufacturers).
- **Combined function model No.** / Easy selection from pre-made combinations of required functions. Selections feature multiple I/Os, so these devices can be used flexibly for a variety of application requirements (especially useful for engineering manufacturers and factory maintenance staff).

Detailed model No. (useful for equipment manufacturers)

●SDC45A I II III IV V VI VII VIII IX X Example: C45A1A1C000000

Segment	Model No. selection	Description			
I	Basic model No. C45A	Standard model			
II	Input	1 1 input (full multiple 1) 2 2 inputs (full multiple 2)			
	Power supply	A 100 to 240 Vac D 24 Vdc			
IV	Outputs 1, 2	1 1 form 1a1b relay 2 2 form 1a relays			
	Outputs 3, 4	C0 Current output (output 3) D0 Continuous voltage output (output 3) V0 Voltage pulse output (output 3) RR 2 form 1a relays CC 2 current outputs VV 2 voltage pulse outputs CV Current (output 3) + voltage pulse (output 4) SS Motor drive triac + MFB input			
VI	Output 5	0 None R Form 1a relay C Current output D Continuous voltage output P Transmitter power supply			
	VII	Outputs 6, 7	0 None		
		VIII	Option	0 2 digital inputs (DI-F1,2) (note 1) 1 10 digital inputs (note 2) 2 2 digital inputs + 8 digital outputs (note 1) 3 2 digital inputs + 8 digital outputs + RS-485 communications (note 1) 4 2 CT inputs (note 3) 5 2 CT inputs + 8 digital inputs (note 3) 6 2 CT inputs + 8 digital outputs (note 3) 7 2 CT inputs + 8 digital outputs + RS-485 communications (note 3)	
			IX	Addition 1	0 None D Inspection certificate Y Supports traceability certification
				X	Addition 2 (note 4)

- Notes : 1. There are no digital inputs if "SS" is selected for Outputs 3, 4.
2. There are 8 digital inputs if "SS" is selected for Outputs 3, 4.
3. Cannot be selected if "SS" is selected for Outputs 3, 4.
4. Additionally, tropicalization and anti-sulfidation treatments can be ordered. However, there are some specifications restrictions. For details, contact the azbil Group.

●SDC46A I II III IV V VI VII VIII IX X Example: C46A1A1C000000

Segment	Model No. selection	Description			
I	Basic model No. C46A	Standard model			
II	Input	1 1 input (full multiple 1) 2 2 inputs (full multiple 2)			
	Power supply	A 100 to 240 Vac D 24 Vdc			
IV	Outputs 1, 2	1 1 form 1a1b relay 2 2 form 1a relays			
	Outputs 3, 4	C0 Current output (output 3) D0 Continuous voltage output (output 3) V0 Voltage pulse output (output 3) RR 2 form 1a relays CC 2 current outputs VV 2 voltage pulse outputs CV Current (output 3) + voltage pulse (output 4) SS Motor drive triac + MFB input R1 Motor drive relay + MFB input			
VI	Output 5	0 None (note 2) R Form 1a relay (note 2) C Current output (note 2) D Continuous voltage output (note 2) P Transmitter power supply (note 2)			
	VII	Outputs 6, 7	0 None 1 Current output (output 6) 2 Transmitter power supply (output 7) 3 2 current outputs (note 1) 4 Current (output 6) + transmitter power supply (output 7)		
		VIII	Option	0 2 digital inputs (DI-F1,2) (note 3) 1 14 digital inputs (note 4) 2 14 digital inputs + 8 digital outputs (note 4) 3 14 digital inputs + 8 digital outputs + RS-485 communications (note 4) 4 2 CT inputs (note 5) 5 2 CT inputs + 12 digital inputs (note 5) 6 2 CT inputs + 12 digital inputs + 8 digital outputs (note 5) 7 2 CT inputs + 12 digital inputs + 8 digital outputs + RS-485 communications 1 (note 5)	
			IX	Addition 1	0 None D Inspection certificate Y Supports traceability certification
				X	Addition 2 (note 6)

- Notes : 1. Not available if "CC" is selected for Outputs 3, 4 and "C" is selected for Output 5.
2. Selection must be "0" if "R1" is selected for Outputs 3, 4.
3. There are no digital inputs if "SS" or "R1" is selected for Outputs 3, 4.
4. There are 12 digital inputs if "SS" or "R1" is selected for Outputs 3, 4.
5. Not available if "SS" or "R1" is selected for Outputs 3, 4.
6. Additionally, tropicalization and anti-sulfidation treatments can be ordered. However, there are some specifications restrictions. For details, contact the azbil Group.

Combined function model No. (with all-orange LED displays, CE marking) (useful for engineering manufacturers and factory maintenance staff)

●SDC45A I II III IV Example: C45A000

Segment	Model No. selection	Description
I	Basic model No. C45A	Standard model : 2 alarm outputs (output 1, 2)
II	Set No.	0 None
III	Option 1	0 Regular type 1: 2 relay outputs (output 3, 4) + 1 current output (output 5) + 2 digital inputs (DI-F 1, 2)
		1 Regular type 2: 1 current output (output 3) + 1 voltage pulse output (output 4) + 1 relay output (output 5) + 2 digital inputs (DI-F 1, 2)
		2 Position proportion type 1: 2 triac outputs (output 3, 4) + 1 relay output (output 5)
		3 Regular type 3: 2 current outputs (output 3, 4) + transmitter power supply (24 Vdc) (output 5) + 2 digital inputs (DI-F 1, 2)
		4 Position proportion type 2: 2 triac outputs (output 3, 4) + transmitter power supply (24 Vdc) (output 5)
IV	Option 2	0 None
		1 Communications (RS-485) + PV inputs 2 + 8 digital outputs
		2 PV input 2 + 8 digital outputs
		3 8 digital outputs
		4 PV input 2

●SDC46A I II III IV Example: C46A000

Segment	Model No. selection	Description
I	Basic model No. C46A	Standard model : 2 alarm outputs (output 1, 2) + 1 current output (output 6)
II	Set No.	0 None
III	Option 1	0 Regular type 1: 2 relay outputs (output 3, 4) + 1 current output (output 5) + 2 digital inputs (DI-F 1, 2)
		1 Regular type 2: 1 current output (output 3) + 1 voltage pulse output (output 4) + 1 relay output (output 5) + 2 digital inputs (DI-F 1, 2)
		2 Position proportion type 1: 2 triac outputs (output 3, 4) + 1 relay output (output 5)
		3 Regular type 3: 2 relay outputs (output 3, 4) + 1 current output (output 5) + transmitter power supply (24 Vdc) (output 7) + 2 digital inputs (DI-F 1, 2)
		4 Position proportion type 2: 2 triac outputs (output 3, 4) + 1 relay output (output 5) transmitter power supply (24 Vdc) (output 7)
IV	Option 2	0 None
		1 Communications (RS-485) + PV inputs 2 + 12 digital inputs + 8 digital outputs
		2 PV input 2 + 12 digital inputs + 8 digital outputs
		3 12 digital inputs + 8 digital outputs
		4 PV input 2

Accessories (sold separately)

Model No.	Description
SLP-C45J60	Smart Loader Package
SLP-C45J61	Smart Loader Package (Without user's manual and loader cable)
81441420-001	Terminal cover set*
81441421-001	Hard cover set (for SDC45A)
81441422-001	Hard cover set (for SDC46A)

*: 2 sets are needed for the SDC46A.

Information about Standards

EMC Directive:	Requires that the electromagnetic generated by the device does not interfere with the operation of communications equipment, and that the device have a certain level of resistance to electromagnetic interference. EN 61326 applies EMC requirements to electric devices for measurement, control and testing.
Low-Voltage Directive:	Requires that devices are safe, that high-level engineering has been applied to ensure safety, and that the design has been made in accordance with the general rules recognized by EU member countries. EN61010-1 defines the safety requirements for electric equipment of measurement, control and test equipment (Part 1: general information).

Memo