

SDC15 Single Loop Controller User's Manual for Basic Operation



Thank you for purchasing an Azbil Corporation product.

This manual contains information for ensuring the correct use of this product. It also provides necessary information for installation, maintenance, and troubleshooting.

This manual should be read by those who design and maintain equipment that uses this product. Be sure to keep this manual nearby for handy reference.

Azbil Corporation

NOTICE

Be sure that the user receives this manual before the product is used.

Copying or duplicating this user's manual in part or in whole is forbidden. The information and specifications in this manual are subject to change without notice.

Considerable effort has been made to ensure that this manual is free from inaccuracies and omissions. If you should find an error or omission, please contact the azbil Group.

In no event is Azbil Corporation liable to anyone for any indirect, special or consequential damages as a result of using this product.

© 2003-2016 Azbil Corporation All Rights Reserved.

SAFETY REQUIREMENTS



To reduce risk of electric shock which could cause personal injury, follow all safety notices in this documentation.



This symbol warns the user of a potential shock hazard where hazardous live voltages may be accessible.

- If the equipment is used in a manner not specified by the manufacturer, the protection provided by the equipment must be impaired.
- Do not replace any component (or part) not explicitly specified as replaceable by your supplier.
- All wiring must be in accordance with local norms and carried out by authorized and experienced personnel.
- A switch in the main supply is required near the equipment.
- Main power supply wiring requires a (T) 0.2A, 250V fuse(s) (IEC 127).

EQUIPMENT RATINGS

| | |
|--------------------|---|
| Supply voltages: | 100 to 240V (operating power supply voltage 85 to 264Vac) |
| Frequency: | 50/60Hz |
| Power consumption: | 12VA maximum |

EQUIPMENT CONDITIONS

Do not operate the instrument in the presence of flammable liquids or vapors.

Operation of any electrical instrument in such an environment constitutes a safety hazard.

| | |
|------------------------|--|
| Temperature: | 0 to 50°C |
| Humidity: | 10 to 90%RH (no condensation) |
| Vibration: | 2m/s ² (10 to 60Hz) |
| Over-voltage category: | Category II (IEC60364-4-443, IEC60664-1) |
| Pollution degree: | Pollution degree 2 |
| Installation location: | Indoors |
| Altitude: | 2000m or less |

EQUIPMENT INSTALLATION

The controller must be mounted into a panel to limit operator access to the rear terminal.

Specifications of common mode voltage: The common mode voltages of all I/O except for main supply and relay outputs are less than 30Vr.m.s, 42.4V peak and 60Vdc.

STANDARDS COMPLIANCE

EN61010-1,

EN61326-1 (For use in industrial locations)

During EMC testing, the reading or output may fluctuate by $\pm 10\%$ FS.

SAFETY PRECAUTIONS

■ About Icons

The safety precautions described in this manual are indicated by various icons. Please be sure you read and understand the icons and their meanings described below before reading the rest of the manual.

Safety precautions are intended to ensure the safe and correct use of this product, to prevent injury to the operator and others, and to prevent damage to property. Be sure to observe these safety precautions.



 **WARNING**

Warnings are indicated when mishandling this product might result in death or serious injury.



 **CAUTION**

Cautions are indicated when mishandling this product might result in minor injury to the user, or only physical damage to the product.











■ Examples

| | |
|---|---|
|  | Use caution when handling the product. |
|  | The indicated action is prohibited. |
|  | Be sure to follow the indicated instructions. |







WARNING

| | |
|---|--|
|  | Do not disassemble the SDC15. Doing so might cause electric shock or faulty operation. |
|  | Before wiring, or removing/mounting the SDC15, be sure to turn the power OFF. Failure to do so might cause electric shock. |
|  | Do not touch electrically charged parts such as the power terminals. Doing so might cause electric shock. |

CAUTION

| | |
|---|--|
|  | Use the SDC15 within the operating ranges recommended in the specifications (temperature, humidity, voltage, vibration, shock, mounting direction, atmosphere, etc.). |
|  | Do not block ventilation holes. Doing so might cause fire or faulty operation. |
|  | Wire the SDC15 properly according to predetermined standards. Also wire the SDC15 using specified power leads according to recognized installation methods. Failure to do so might cause electric shock, fire or faulty operation. |
|  | Do not allow lead clippings, chips or water to enter the controller case. Doing so might cause fire or faulty operation. |
|  | Firmly tighten the terminal screws at the torque listed in the specifications. Insufficient tightening of terminal screws might cause electric shock or fire. |
|  | Do not use unused terminals on the SDC15 as relay terminals. Doing so might cause electric shock, fire, or faulty operation. |
|  | We recommend attaching the terminal cover (sold separately) after wiring the SDC15. Failure to do so might cause electric shock, fire, or faulty operation. |
|  | Continued use of the relays after the recommended service life has expired might cause fire or faulty operation. Failure to do so might cause fire or faulty operation. |
|  | If there is a risk of a power surge caused by lightning, use a surge absorber (surge protector) to prevent fire or device failure. |
|  | Do not make incorrect connections. If the cables are connected incorrectly, this might cause the unit to malfunction. |
|  | The controller does not function for approximately 6 sec. after the power has been turned ON. Great care should be taken when the relay output from the controller is used as interlock signals. |

CAUTION

| | |
|--|---|
|  | The part between the control output 1 and control output 2 is not isolated. When necessary, use an appropriate isolator. |
|  | Do not connect multiple loader cables to multiple units from one personal computer. The current coming from other circuits might cause the PV value indication error to occur. |
|  | Do not connect any terminating resistor to both ends of the communication path when performing the RS-485 wiring. Doing so might cause the communication to fail. |
|  | Always mount a switch for shut-down of the main power of this unit in an easily accessible area of the operator when performing electric wiring of this unit. Additionally, connect a slow-action type (T) fuse having a rated current of 0.2A and rated voltage of 250V to the wiring for the instrument power supply of the AC power supply model. (IEC127) |
|  | Do not operate the key with a propelling pencil or sharp-tipped object. Doing so might cause faulty operation. |
|  | This unit incorporates the self-tuning function without use of control constant settings in addition to the ON/OFF control and conventional PID control. This self-tuning control monitors and studies the characteristics of the control subject even if the SP value is changed or external disturbance occurs in order to automatically calculate the control constants. This ensures stable control all the time. |

Important notice

The protective film is adhered to the front console of this unit to protect the surface.

After the installation and wiring work has been completed, stick a scotch tape to the corner of the console and pull it out in the direction indicated by an arrow to peel off the protective film.

Handling Precautions

If you attempt to peel off the protective film with your fingernail, this might cause damage to the console.

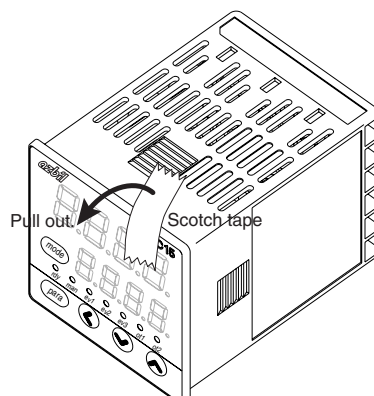

The Role of This Manual

Five different manuals in total are available for the SDC15 Single Loop Controller (hereafter referred to as "this unit"). Read appropriate manuals according to your requirements. If you do not have your required manual, contact the azbil Group or its dealer. Additionally, you can download necessary manuals from "<http://www.azbil.com>".

The user level of this unit can be selected from three levels, "Simple configuration", "Standard configuration", and "High function configuration". This manual describes the functions you can set up only with "Simple configuration". If more advanced application is needed, refer to SDC15 Single Loop Controller User's Manual for Installation & Configuration (CP-SP-1148E).

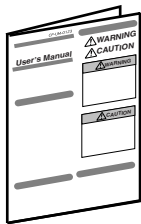

SDC15 Single Loop Controller User's Manual for Installation Manual No. CP-UM-5287E

This manual is supplied with the product. Personnel in charge of design and/or manufacture of a system using this unit must thoroughly read this manual. This manual describes the safety precautions, installation, wiring, and primary specifications. For further information about operation, refer to other manuals, Basic Operation and/or Installation & Configuration.

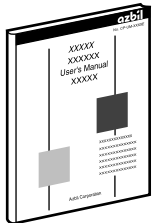

SDC15 Single Loop Controller User's Manual for Basic Operation Manual No. CP-SP-1147E

This manual is optional (sold separately). The manual describes the functions you can set up only with "Simple configuration". Personnel in charge of design, manufacture, operation, and/or maintenance of a system using this unit must thoroughly read this manual. This manual describes the installation, wiring, major functions and settings, operating procedures, troubleshooting, and detailed specifications.

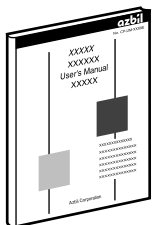

SDC15 Single Loop Controller User's Manual for Installation & Configuration Manual No. CP-SP-1148E

This manual is optional (sold separately). The manual describes the hardware and all functions of this unit. Personnel in charge of design, manufacture, operation, and/or maintenance of a system using this unit and those in charge of communication software of a system using the communication functions of this unit must thoroughly read this manual. This manual also describes the installation, wiring, connections for communication, all functions and settings of this unit, operating procedures, communication with host station, such as personal computer, communication addresses, troubleshooting, and detailed specifications.

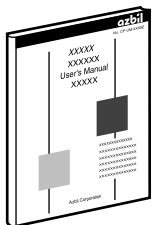

SLP-C35 Smart Loader Package for SDC15/25/26/35/36 Single Loop Controller User's Manual Manual No. CP-UM-5290E

This manual is supplied with the Smart Loader Package. The manual describes the software used to make various settings for SDC15/25/26/35/36 using a personal computer. Personnel in charge of design or setting of a system using SDC15/25/26/35/36 must thoroughly read this manual. The manual describes installation of the software into a personal computer, operation of the personal computer, various functions, and setup procedures.

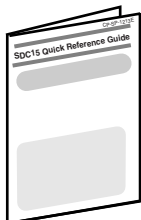

SDC15 Quick Reference Guide Manual No. CP-UM-1213E

For those using the SDC15 for the first time or for operators on the work site, this guide serves as a reference when setting or modifying parameters. Key operations, menu flowcharts and parameter settings are presented with color illustrations.

Organization of This User's Manual

This manual is organized as follows:

Chapter 1. OVERVIEW

This chapter describes the applications, features, model selection guide, and part names and functions of this unit. Since the part names described in this chapter are used in the subsequent descriptions, the part names and functions of this unit must be understood correctly in this chapter.

Chapter 2. OUTLINE OF FUNCTIONS

This chapter describes the outline and operation flow of the functions of this unit.

Chapter 3. INSTALLATION

This chapter describes the environmental conditions, installation dimensions, installation procedures, and necessary tools when installing this unit.

Chapter 4. WIRING

This chapter describes the wiring procedures, wiring precautions, and connection examples.

Chapter 5. SETTINGS BEFORE STARTING OPERATION

This chapter describes the items necessary to set up before starting operation and setting procedures.

Chapter 6. SETTINGS DURING OPERATION

This chapter describes the setting items and setting procedures when performing the control with this unit built-into the customer's system.

Chapter 7. LIST OF SIMPLE CONFIGURATION DISPLAY ITEMS

This chapter shows the list of the setting items when operating this unit with "Simple configuration".

Chapter 8. PID CONTROL TUNING

This chapter describes the auto tuning function and self-tuning function of this unit.

Chapter 9. MAINTENANCE AND TROUBLESHOOTING

This chapter describes the maintenance and inspection of this unit, as well as troubleshooting.

Chapter 10. DISPOSAL

This chapter describes safety precautions and how to dispose of this unit when the unit is no longer used.

Chapter 11. SPECIFICATIONS

This chapter describes the general specifications, performance specifications, and optional parts of this unit.

Contents

| | |
|------------------------------------|--|
| SAFETY REQUIREMENTS | |
| SAFETY PRECAUTIONS | |
| Important Notice | |
| The Role of This Manual | |
| Organization of This User's Manual | |
| Conventions Used in This Manual | |

Chapter 1. OVERVIEW

| | |
|--|-----|
| 1-1 Overview..... | 1-1 |
| ■ Model selection table | 1-2 |
| ■ Accessories and optional parts | 1-3 |
| 1-2 Part Names and Functions..... | 1-4 |
| ■ Main body and console | 1-4 |
| ■ Bottom panel | 1-5 |
| ■ Rear panel | 1-6 |

Chapter 2. OUTLINE OF FUNCTIONS

| | |
|--|-----|
| 2-1 Input/Output Configuration | 2-1 |
| 2-2 Key Operation | 2-2 |
| ■ Data setting procedures | 2-3 |
| ■ [mode] key operating procedures..... | 2-5 |
| 2-3 Operation Modes | 2-6 |

Chapter 3. INSTALLATION

| | |
|--------------------------------|-----|
| ■ Installation place..... | 3-1 |
| ■ External Dimensions..... | 3-2 |
| ■ Panel Cutout Dimensions..... | 3-2 |
| ■ Mounting procedures | 3-3 |

Chapter 4. WIRING

| | |
|---|------|
| 4-1 Wiring..... | 4-1 |
| ■ Terminal assignment label symbols | 4-2 |
| ■ Wiring Precautions | 4-2 |
| ■ Connection of open collector output to digital input..... | 4-5 |
| ■ Connection of (RS-485) communication cable | 4-5 |
| ■ Connection with SSR (solid state relay)..... | 4-7 |
| ■ Noise Preventive Measures | 4-10 |
| 4-2 Recommended Cables..... | 4-11 |

Chapter 5. SETTINGS BEFORE STARTING OPERATION

| | | |
|-----|---|------|
| 5-1 | PV Input | 5-2 |
| ■ | PV range type setup | 5-2 |
| ■ | Temperature unit setup | 5-4 |
| ■ | Decimal point position setup | 5-5 |
| ■ | PV input range low limit/high limit setup | 5-6 |
| 5-2 | Control | 5-7 |
| ■ | Control method setup | 5-7 |
| ■ | Control action (Direct/Reverse) setup | 5-8 |
| ■ | Heat/Cool control selection setup | 5-9 |
| ■ | Heat/Cool control dead band setup | 5-10 |
| ■ | LSP system group setup | 5-12 |
| 5-3 | Internal Event | 5-13 |
| ■ | Event operation type setup | 5-19 |
| ■ | Event Direct/Reverse, standby, and Event state at READY setup | 5-20 |
| ■ | Event main setting setup | 5-21 |
| ■ | Event sub-setting setup | 5-22 |
| ■ | Event hysteresis setup | 5-23 |
| 5-4 | CT (Current Transformer) Input | 5-24 |
| ■ | CT type setup | 5-24 |
| ■ | CT output setup | 5-25 |
| ■ | CT wait time before measurement setup | 5-26 |
| 5-5 | Continuous Output | 5-27 |
| ■ | Output range setup | 5-27 |
| ■ | Output type setup | 5-28 |
| ■ | Output scaling low limit/high limit setup | 5-29 |
| ■ | MV scaling range | 5-30 |
| 5-6 | Communication | 5-31 |
| ■ | Communication mode setup | 5-31 |
| ■ | Station address setup | 5-32 |
| ■ | Transmission speed setup | 5-33 |
| ■ | Data format (data length) setup | 5-34 |
| ■ | Data format (parity) setup | 5-35 |
| ■ | Data format (stop bit) setup | 5-36 |
| 5-7 | Key Operation | 5-37 |
| ■ | Mode key function setup | 5-37 |
| ■ | User level setup | 5-38 |
| 5-8 | DI Assignment | 5-39 |
| ■ | Internal contact operation type setup | 5-39 |

Chapter 6. SETTINGS DURING OPERATION

| | | |
|-----|--|-----|
| 6-1 | SP | 6-1 |
| ■ | SP setup in operation display mode | 6-1 |
| ■ | LSP No. setup | 6-2 |
| ■ | SP setup in parameter setting display mode | 6-3 |

| | | |
|-----|--|------|
| 6-2 | Operation Display other than SP..... | 6-4 |
| | ■ MV (manipulated variable) display and setup | 6-4 |
| | ■ Heat MV (manipulated variable) and cool MV (manipulated variable) display | 6-5 |
| | ■ AT (auto tuning) progress display | 6-5 |
| | ■ CT (current transformer) input 1/2 current value display..... | 6-6 |
| 6-3 | Mode..... | 6-7 |
| | ■ AUTO/MANUAL mode selection setup | 6-7 |
| | ■ RUN/READY mode selection setup | 6-8 |
| | ■ AT (auto tuning) Stop/Start selection setup..... | 6-9 |
| | ■ Release all DO (digital output) latches setup | 6-10 |
| | ■ Communication DI (digital input) 1 setup | 6-11 |
| 6-4 | PID | 6-12 |
| | ■ P-1 (proportional band) setup..... | 6-12 |
| | ■ I-1 (Integral time) setup | 6-13 |
| | ■ d-1 (Derivative time) setup..... | 6-14 |
| | ■ rE-1 (Manual reset) setup | 6-15 |
| | ■ P-1C (Proportional band - cool) setup | 6-16 |
| | ■ I-1C (Integral time - cool) setup | 6-17 |
| | ■ d-1C (Derivative time - cool) setup..... | 6-18 |
| 6-5 | Other Parameter Setup | 6-19 |
| | ■ ON/OFF control differential setup..... | 6-19 |
| | ■ PV filter setup..... | 6-20 |
| | ■ PV bias setup..... | 6-21 |
| | ■ Time proportional cycle time 1/2 setup | 6-22 |
| | ■ MV low limit/high limit at AT (auto tuning)..... | 6-23 |
| | ■ AT type setup..... | 6-24 |
| | ■ Key lock setup | 6-25 |
| | ■ Password lock function..... | 6-26 |
| | ■ Password display setup | 6-27 |
| | ■ Passwords (1A, 2A, 1B, 2B) setup | 6-28 |

Chapter 7. LIST OF SIMPLE CONFIGURATION DISPLAY ITEMS

| | | |
|-----|---|-----|
| 7-1 | List of Operation Displays | 7-1 |
| 7-2 | List of Parameter Setting Displays..... | 7-2 |
| 7-3 | List of Setup Setting Displays | 7-5 |

Chapter 8. PID CONTROL TUNING

| | | |
|-----|--|-----|
| 8-1 | AT (auto tuning) Function | 8-2 |
| | ■ Starting procedures | 8-2 |
| | ■ Stopping procedures | 8-2 |
| 8-2 | ST (Self-tuning) Function | 8-4 |
| | ■ Starting procedures | 8-4 |
| | ■ Stopping procedures | 8-5 |
| 8-3 | Precautions for ST (Self-tuning) | 8-6 |

Chapter 9. MAINTENANCE AND TROUBLESHOOTING

- Maintenance 9-1
- Alarm display and corrective action 9-1
- Operation in case of PV input failure 9-2

Chapter 10. DISPOSAL

Chapter 11. SPECIFICATIONS

- Specifications 11-1
- Accessories and optional parts 11-4

Appendix

- Glossary Appendix-1

Index

Conventions Used in This Manual

The following conventions are used in this manual:

Handling Precautions

: Handling Precautions indicate items that the user should pay attention to when handling the SDC15.

Note

: Notes indicate useful information that the user might benefit by knowing.



: This indicates the item or page that the user is requested to refer to.

(1), (2), (3)

: The numbers with the parenthesis indicate steps in a sequence or indicate corresponding parts in an explanation.











[para], [mode] etc. : These indicate keys on the keyboard.

>>

: This indicates the operation results and the status after operation.



















































● Numeric value and character display on LED

Numeric values The 7-segment LED expresses numeric values as follows:

| | | | | | | | | | |
|---|---|---|---|---|--|---|---|---|---|
| 0 |  | 1 |  | 2 |  | 3 |  | 4 |  |
| 5 |  | 6 |  | 7 |  | 8 |  | 9 |  |

Alphabetical characters The 7-segment LED expresses alphabetical characters as follows:

There are some alphabetical characters, which are not displayed on the LED.

| | | | | | | | | | |
|---|---|---|---|---|--|---|---|---|---|
| A |  | B |  | C |  | D |  | E |  |
| a |  | b |  | c |  | d |  | e |  |
| F |  | G |  | H |  | I |  | J |  |
| f |  | g |  | h |  | i |  | j |  |
| K |  | L |  | M |  | N |  | O |  |
| k |  | l |  | m |  | n |  | o |  |
| P |  | Q |  | R |  | S |  | T |  |
| p |  | q |  | r |  | s |  | t |  |
| U |  | V |  | Y |  | Z |  | - |  |
| u |  | v |  | y |  | z |  | |  |

Handling Precautions

As shown above, numeric value "2" and alphabetic character "Z" are shown in the same manner.

Accordingly, numeric value "5" and alphabetic character "S", as well as numeric value "9" and alphabetic character "Q" are also shown in the same manner.

Chapter 1. OVERVIEW

1 - 1 Overview

This unit is a compact controller having a mask of 48 X 48 mm and provides the following features:

- The depth is only 60 mm, providing the excellent space-saving.
- The front panel is only 2 mm thick. This ensures the excellent thin design.
- The display panel is large. This provides excellent visibility.
- [mode] key, [para] key, and digit-shift keys are provided on the front panel. This ensures easy setup operation.
- Various input types are available, thermocouples (K, J, E, T, R, S, B, N, PLII, WRe5-26, PR40-20, DIN U, DIN L), RTDs (Pt100, JPt100), current signals (4 to 20mA_{dc}, 0 to 20mA_{dc}), and voltage signals (0 to 1V_{dc}, 1 to 5V_{dc}, 0 to 5V_{dc}, and 0 to 10V_{dc}).
- For control outputs, relay, voltage pulse, and current output are provided. Additionally, these control outputs can be combined for the 2nd control output.
- The unit can be made applicable to the heat/cool control using the 2nd control output and/or event relay.
- ON/OFF control, fixed PID, and self-tuning control can be performed.
- In addition to the PID control, two algorithms, RationalLOOP and Just-FiTTER, are mounted. This ensures excellent controllability.
- With optional functions, a combination among 3-event points or 2-event points (independent contacts), 2-point CT input, 2-point digital input, and/or RS-485 can be selected.
- The personal computer loader port is provided as standard function. The setup can be made easily with use of the personal computer loader.
- Use of optional Smart Loader Package (SLP-C35) makes it possible to easily perform the read/write operation of the parameters. In addition to the table format setup, the operation and control status can be monitored using the trend display. This unit can be operated without use of program on the host unit.
- The unit is applicable to the IEC directive and the CE marking is put on the unit.
(Applicable standards: EN61010-1 and EN61326-1)

■ Model selection table

The following shows the model selection table of this unit:

| Basic model No. | Mounting | Control output | PV input | Power supply | Option | Additional treatment | | Specifications | |
|-----------------|----------|----------------|----------------------------------|--------------|--------|----------------------|---|--|--|
| | | | | | | 1 | 2 | | |
| C15 | | | | | | | | | |
| | T | | | | | | | | Panel mount type |
| (Note 4) | S | | | | | | | | Socket mount type |
| | | | | | | | | Control output 1 | Control output 2 |
| (Note 2) | R0 | | | | | | | Relay contact output | None (relay output for control output 1: N.C.) |
| | V0 | | | | | | | Voltage pulse output (for SSR drive) | None |
| (Note 1) | VC | | | | | | | Voltage pulse output (for SSR drive) | Current output |
| (Note 1) | VV | | | | | | | Voltage pulse output (for SSR drive) | Voltage pulse output (for SSR drive) |
| | C0 | | | | | | | Current output | None |
| (Note 1) | CC | | | | | | | Current output | Current output |
| | | T | | | | | | Thermocouple input (K, J, E, T, R, S, B, N, PL II, WRe5-26, PR40-20, DIN U, DIN L) | |
| | | R | | | | | | RTD input (Pt100/JPt100) | |
| | | L | | | | | | DC voltage/DC current input (0 to 1Vdc, 1 to 5Vdc, 0 to 5Vdc, 0 to 10Vdc, 0 to 20mAdc, 4 to 20mAdc) | |
| | | | A | | | | | AC Model (100 to 240Vac) | |
| | | | D | | | | | DC Model (24Vac/24 to 48Vdc) | |
| | | | | 00 | | | | None | |
| | | | | 01 | | | | Event relay output: 3 points | |
| | | | (Note 1) (Note 3) | 02 | | | | Event relay output: 3 points Current transformer input: 2 points Digital input: 2 points | |
| | | | (Note 1) (Note 3) | 03 | | | | Event relay output: 3 points Current transformer input: 2 points RS-485 communication | |
| | | | (Note 5) | 04 | | | | Event relay output: 2 points (independent contact) | |
| | | | (Note 1) (Note 3) (Note 5) | 05 | | | | Event relay output: 2 points (independent contact) Current transformer input: 2 points Digital input: 2 points | |
| | | | (Note 1) (Note 3) (Note 5) | 06 | | | | Event relay output: 2 points (independent contact) Current transformer input: 2 points RS-485 communication | |
| | | | | 0 | | | | No additional processing | |
| | | | | D | | | | Inspection Certificate provided | |
| | | | | Y | | | | Complying with the traceability certification | |
| | | | | | | 0 | | None | |
| | | | | | | A | | UL-marked product | |

- Note 1. Can not be selected for the C15S.
- Note 2. Only 1a contact is applicable for C15S
- Note 3. Current transformer sold separately
- Note 4. Socket sold separately
- Note 5. Can not be selected for the DC Model.

■ Accessories and optional parts

| Name | Model No. |
|--|--------------------------|
| Mounting bracket (for C15T) | 81409651-001 (Accessory) |
| Gasket | 81409657-001 (Accessory) |
| Current transformer (800 turns, 5.8mm hole dia.) | QN206A* |
| Current transformer (800 turns, 12mm hole dia.) | QN212A* |
| Socket (for C15S) | 81446391-001 |
| Hard cover | 81446442-001 |
| Soft cover | 81446443-001 |
| Terminal cover | 81446898-001 |
| Smart Loader Package | SLP-C35J50 |
| L-shaped plug adaptor | 81441057-001 |

* Not UL-certified.

1 - 2 Part Names and Functions

■ Main body and console

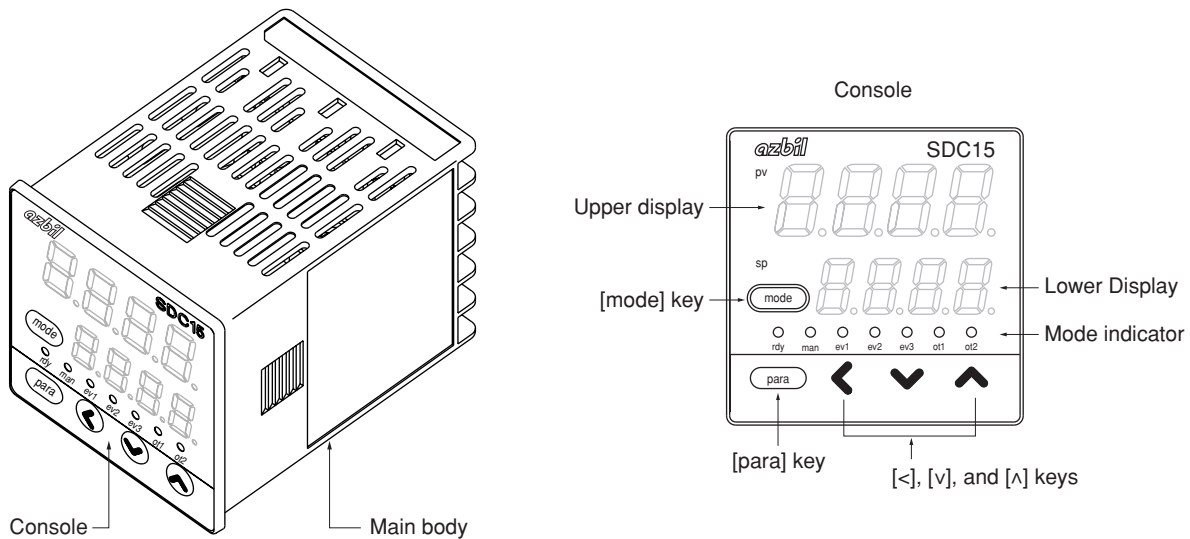

Main body: Contains the electric circuit for I/O signals of measuring instruments, CPU, and memory.

Console: Contains the display panel showing numeric value and status, and operation keys.

● Detailed description of console

[mode] key

When this key is kept pressed for 1 sec. or longer in the operation display mode, any of the following operations, which have been set previously, can be performed:

- AUTO/MANUAL mode selection
- RUN/READY mode selection
- AT (Auto Tuning) stop/start selection
- LSP (Local SP) group selection
- Release all DO (Digital Output) latches
- ON/OFF selection of communication DI (Digital Input) 1

Additionally, when pressing the [mode] key in the setup display mode, the display is changed to the operation display.

[para] key

This key is used to change the display item.

When this key is kept pressed for 2 sec. or longer in the operation display mode, the display is then changed to the setup display.

<, [v], [^] keys

These keys are used to increase or decrease the numeric value, or to shift the digit.

Upper display

This display shows the PV value or the name of each display item (display value or set value). If an alarm occurs in the operation display mode, the normal display and alarm code are displayed alternately.

The decimal point at the right end digit shows AT (auto tuning) or ST (self-tuning) status. The decimal point flashes twice repeatedly during execution of AT while it flashes once repeatedly during execution of ST.

Lower display

This display shows the SP value, or the display value or set value of each display item. The decimal point at the right end digit shows the communication status.

Mode indicators

| | |
|----------------------|---|
| [rdy]: | RUN/READY mode indicator. Lights when READY |
| [man]: | AUTO/MANUAL mode indicator. Lights when MANUAL |
| [ev1], [ev2], [ev3]: | Event 1 to 3 output indicator. Lights when event relays are ON. |
| [ot1], [ot2]: | Control 1 to 2 output indicator. Lights when the control output is ON. The indicators are always lit when the current output is used. |

! Handling Precautions

- To select the LSP group using the [mode] key, it is necessary to set a value of "2" or more in [LSP system group].
- To show the communication status using the decimal point at the right end digit on the lower display, select "High function configuration" and make the [LED monitor] settings.
- Do not operate the key with a sharp object (such as tip of mechanical pencil or needle). Doing so might cause the unit to malfunction.

■ Bottom view

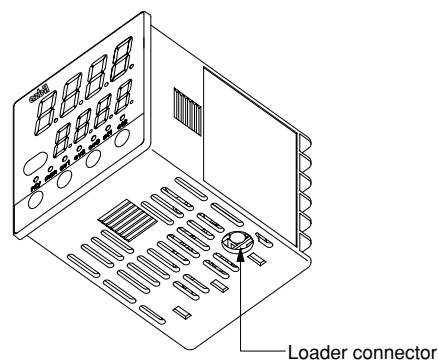

Loader connector: This connector is connected to a personal computer using the dedicated cable supplied with the Smart Loader Package.

■ Rear panel

● Panel mount type

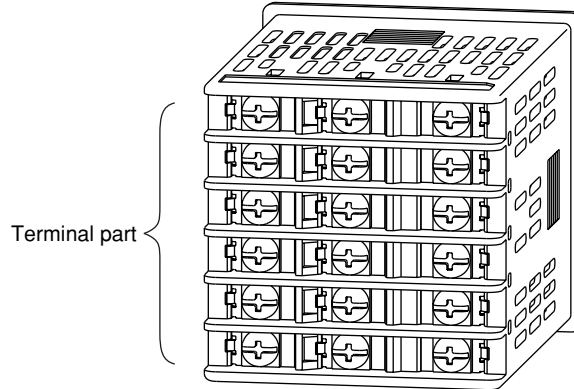

Terminal part: The power supply, input, and output are connected to the terminals. The M3 screw is used. When connecting to the terminal, always use a correct crimp terminal suitable for the M3 screw. The tightening torque of the terminal screw is 0.4 to 0.6N·m.

● Socket mount type

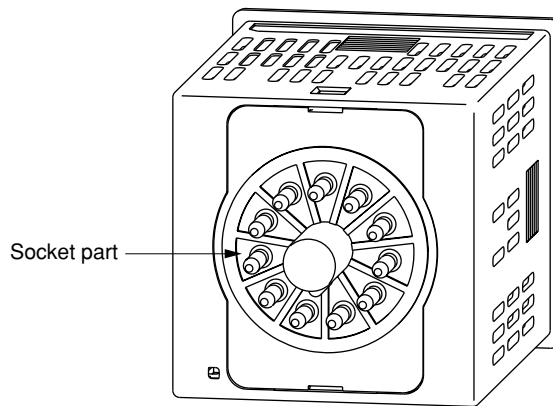

Socket part: This socket is inserted into the optional socket. The power supply, input, and output are connected from the socket. When performing the wiring from the socket, always use a correct crimp terminal suitable for the M3.5 screw. The tightening torque of the socket terminal screw is 0.78 to 0.98N·m or less.

Chapter 2. OUTLINE OF FUNCTIONS

2 - 1 Input/Output Configuration

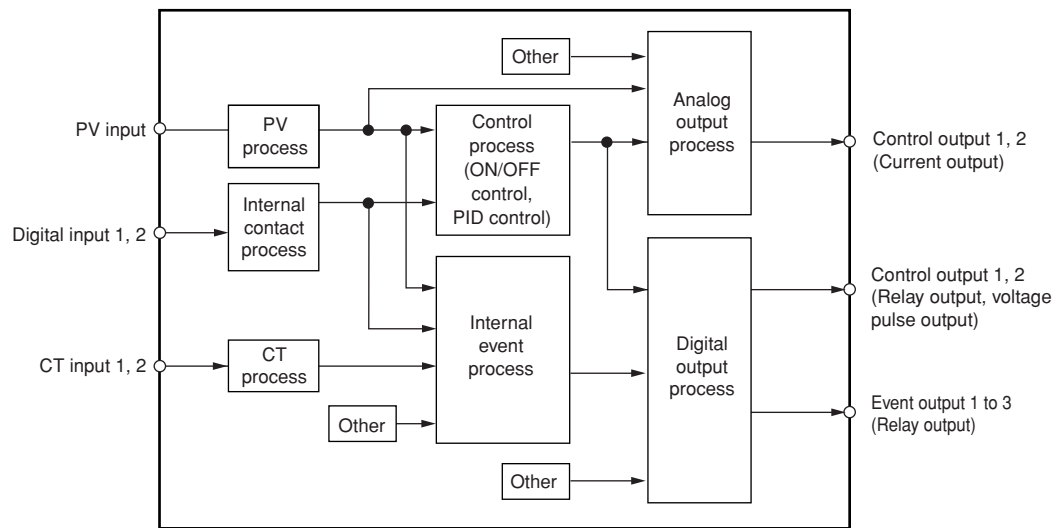

- **PV input**

Sensor or range is selected for the PV input. The selection range may vary depending on the input type of the model (T: Thermocouple, R: RTD, L: DC current, DC voltage).

- **Control output**

When the control output type of the model is "R: Relay" or "V: Voltage pulse", the control output becomes the ON-OFF control output or time proportional output. When the time proportional output is used, the time proportioning cycle time can be set. When the control output type of the model is "C: Current", the control output becomes the continuous output (analog output). When the model has two control outputs, the heat/cool control can be used only with "Simple configuration".

- **Event output**

When the model provides the event, the alarm or control mode set in [Event type] can be output as DO (digital output).

- **DI (digital input)**

When the model provides the DI, the function set with the DI assignments can be selected.

- **CT (current transformer) input**

When the model provides the CT input, the heater burnout alarm can be output from the event output.

2 - 2 Key Operation

The following shows the flow of the general key operation. Various displays and settings can be called up to the console.

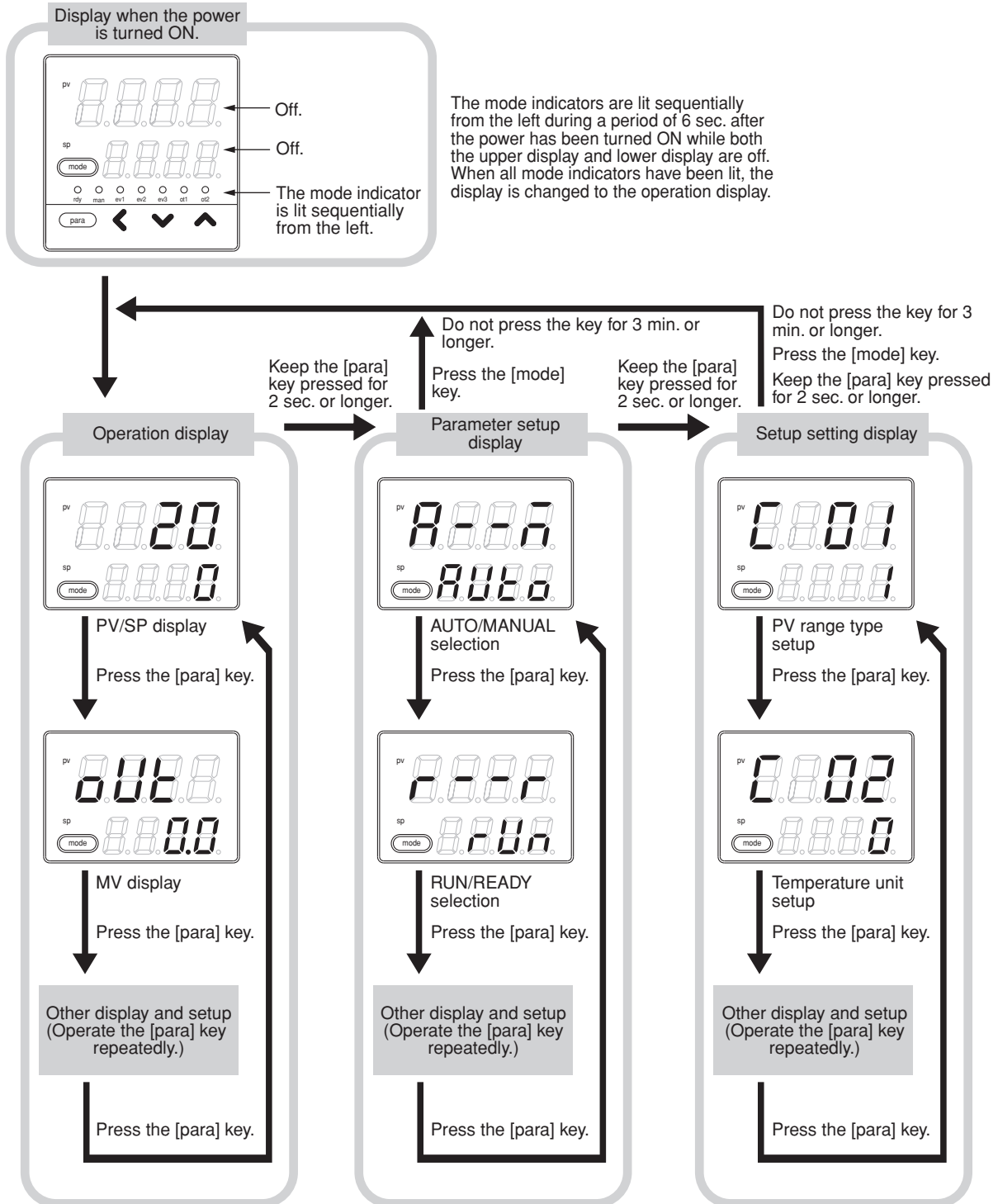

The display and setup status shown above are examples for explanation. Therefore, some displays or settings are not shown actually according to the model and/or setup contents.

! Handling Precautions

- For details about display and setup contents of the operation display, parameter setting display, and setup setting display, refer to
 - ☞ 7-1 List of Operation Displays (on page 7-1),
 - 7-2 List of Parameter Setting Displays (on page 7-2) and
 - 7-3 List of Setup Setting Displays (on page 7-5).
- When pressing the [\leftarrow] key with the [para] key kept pressed instead of pressing of the [para] key, various displays and settings can be operated in the reverse order. However, the operation that both the [para] key and [\leftarrow] key are kept pressed for 2 sec. or longer, is invalid.

■ Data setting procedures

(1) Operate the [para] key to display desired data to be set.

(How to operate the [para] key is described in the previous section, "Flow of general key operation".)

(2) Press any of the [\leftarrow], [\vee], and [\wedge] keys.

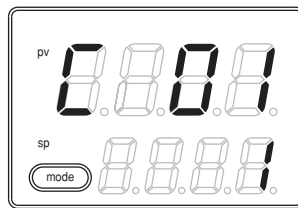

(This Figure shows the display when setting the PV range type of the setup setting [C01].)

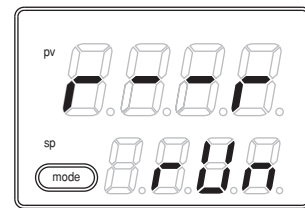

(This Figure shows the display when setting the RUN/Ready selection in the parameter setting [r...r].)



>> When the display No. 2 shows a numeric value, the 1st digit starts flashing. Additionally, when the display No. 2 shows a character string, the entire character string starts flashing.

When a numeric value is displayed, the value can be increased or decreased or the flashing digit can be moved using the [\leftarrow], [\vee], or [\wedge] key.

When a character string is displayed, the entire flashing character string can be changed using the [\vee] or [\wedge] key.

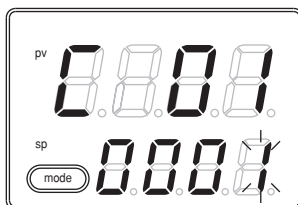

(This Figure shows the display when the 1st digit of "0001" is flashing.)

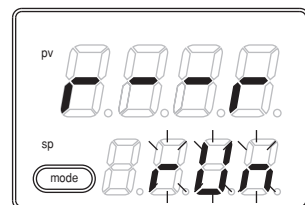

(This Figure shows the display when the entire character string "rUn" is flashing.)



(3) Do not press the key for 2 sec.

>> The flashing display is stopped, and then the data you have changed is set.

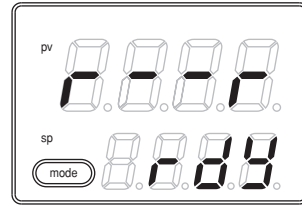
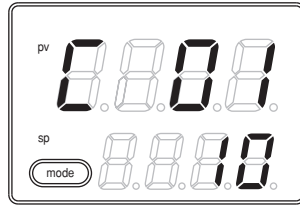

! Handling Precautions

- If the data does not start flashing even though the [<], [v], or [^] key is pressed, this data cannot be changed.
- If the character string cannot be changed using the [v] key while the entire character string is flashing, press the [^] key.
On the contrary, if the character string cannot be changed using the [^] key, press the [v] key .
- When pressing the [para] key while the display is flashing, the next data is displayed without changing of the data. Additionally, when pressing the [mode] key while the display is flashing, the display is returned to the operation display without changing of the data.
- The MV (manipulated variable) display in the MANUAL mode continues the flashing status even after pressing of the key has been stopped. At this time, the flashing value is output as MV.

■ [mode] key operating procedures

When the [mode] key is kept pressed for 1 sec. or longer on the operation display, the selection operation, which has been set using the [mode] key function ([C72]) of the setup setting, can be performed.

The Figure on the right shows an example that the [mode] key is pressed in the RUN/READY selection ([C72] = 2) setting.

(1) If the current mode is the READY mode when the PV/SP is shown on the operation display, the character string "rUn" on the display No. 2 starts flashing.

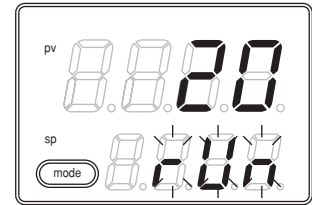

(2) When the [mode] key is kept pressed for 1 sec. or longer, the READY mode is changed to the RUN mode and the flashing of the character string "rUn" is stopped.

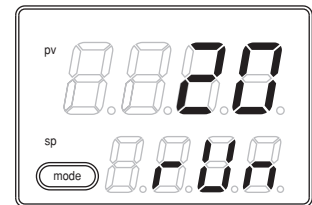

(3) When pressing of the [mode] key is stopped, the display is returned to the PV/SP display.

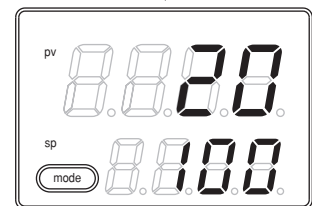

! Handling Precautions

- If the MODE key function of the setup setting is set disabled ([C72] = 0) or if the set selection operation is invalid, the selection operation cannot be performed using the [mode] key.
- When pressing the [mode] key on the parameter setting display or setup setting display instead of the operation display, the display is returned to the operation display. However, even though the [mode] key is kept pressed continually, the selection operation cannot be performed. In this case, stop pressing the key once, and then press the [mode] key.

The user level of this unit can be selected from three levels, "Simple configuration", "Standard configuration", and "High function configuration".

! Handling Precautions

Even though the user level is changed, the functions other than setting display cannot be changed. The user level is set to "Standard configuration" or "High function configuration" and more advanced functions are set. After that, when the setup is returned to "Simple configuration", this function setup cannot be displayed, but the function itself is operated.

2 - 3 Operation Modes

The following shows the transition of operation modes.

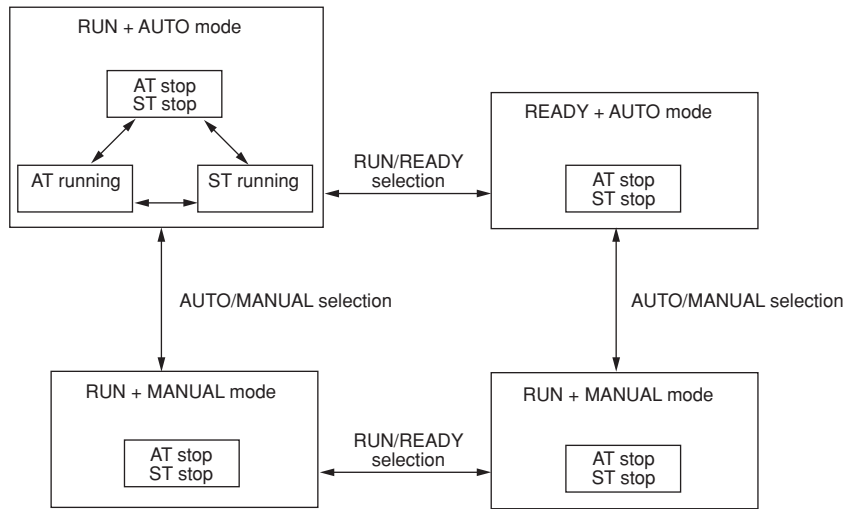

RUN: Control status

READY: Control stop status

AUTO: Automatic operation (This unit automatically determines the MV values.)

MANUAL: Manual operation (The MV values are operated manually.)

AT: Auto tuning (The PID constants are set automatically using the limit cycle.)

ST: Self-tuning (The PID constants are set automatically while the control is kept continuously.)

Chapter 3. INSTALLATION

CAUTION



Use the SDC15 within the operating ranges recommended in the specifications (temperature, humidity, voltage, vibration, shock, mounting direction, atmosphere, etc.).
Failure to do so might cause fire or faulty operation.



Do not block ventilation holes.
Doing so might cause fire or faulty operation.

■ Installation place

Install the controller in the following locations:

- With the exception of supply power and relay contact output, the I/O common mode voltage to ground must be 30 VRMS max., 42.4 V peak max., 60 Vdc max.
- Not high or low temperature/humidity.
- Free from sulfide gas or corrosive gas.
- Less dust or soot.
- Appropriately processed locations to prevent direct sunlight, wind or rain.
- Less mechanical vibration and shock.
- Not close to the high voltage line, welding machine or electrical noise generating source.
- The minimum 15 meters away from the high voltage ignition device for a boiler.
- Less effect by the magnetic.
- No flammable liquid or gas.
- Indoors.

External Dimensions

Panel Mount type (C15T)

Unit: mm

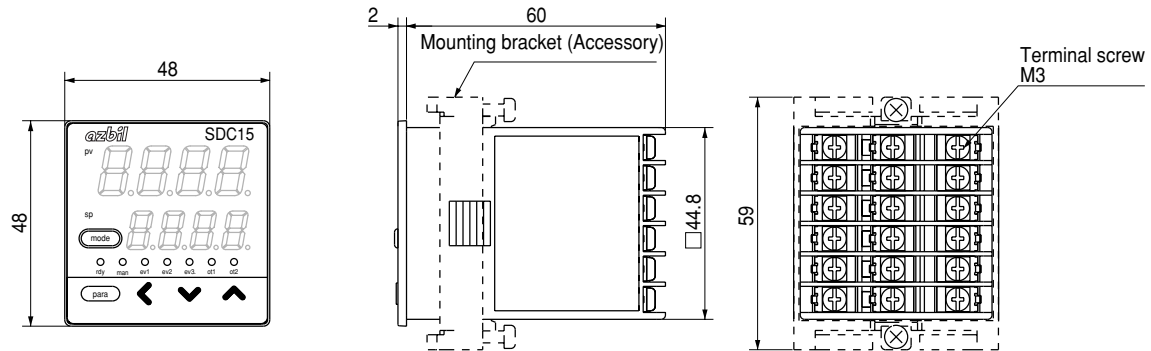

Socket Mount type (C15S)

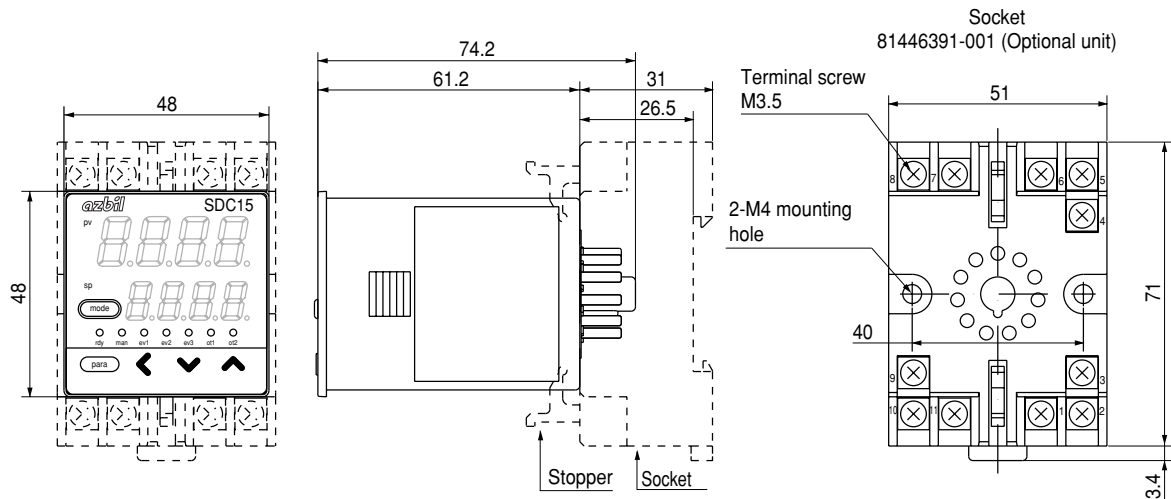

Panel Cutout Dimensions

For panel mounting type, make the mounting holes according to the panel hole making dimensions.

Unit: mm

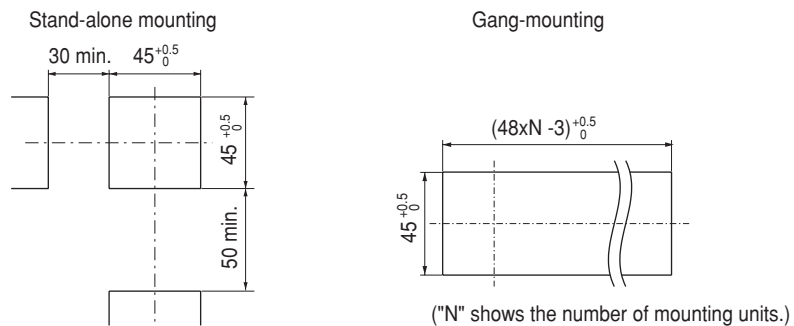

Handling Precautions

- When three or more units are gang-mounted horizontally, the maximum allowable ambient temperature is 40°C.
- Provide a space of at least 50 mm or more above and below the controller.
- If dustproof or waterproof protection is required, mount the device using the stand-alone mounting method. If gang-mounted, dustproof and waterproof protection may not be maintained.

■ Mounting procedures

- The mounting must be horizontal within 10 degrees tilted in back side lowering or within 10 degrees tilted in back side rising.
- In the case of panel mount type (C15T), the mounting panel should be used with a thickness of less than 9 mm of firm board.

● Panel mount type (C15T)

Items to be prepared:

Phillips-head screwdriver

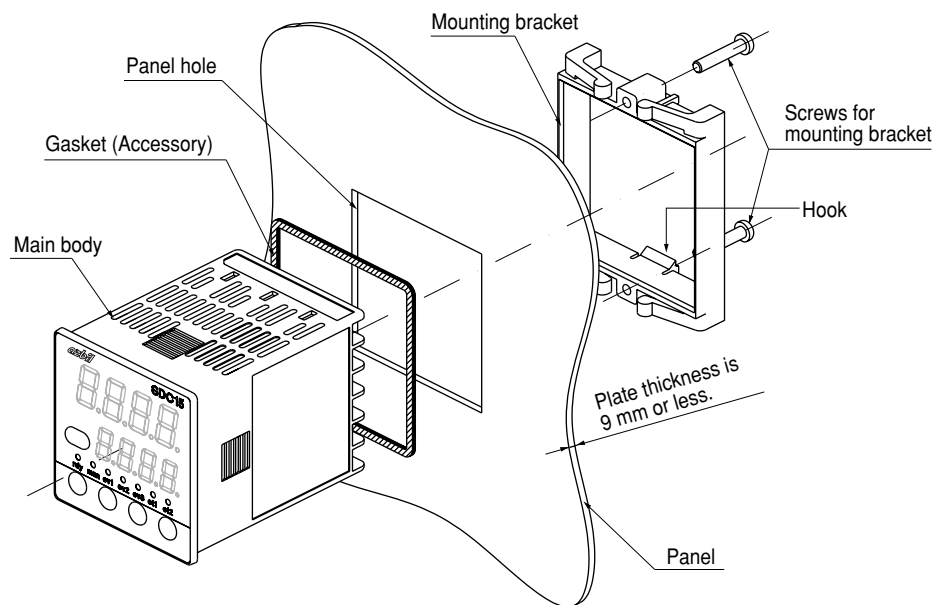

The above Figure shows the waterproof mounting using the gasket. The gasket is not used for normal panel mounting.

- (1) Insert this unit from the front of the panel.
- (2) Fit the mounting bracket from the back of the panel.
- (3) Push the mounting bracket against the panel until the hook of the mounting bracket is firmly engaged with the groove of the main body.
- (4) Tighten the upper and lower screws of the mounting bracket.

For waterproof mounting:

The panel mounting type (C15T) can be waterproof-mounted.

To do so, attach the accessory gasket to the main body before above step (1).

After that, mount the main body with the gasket attached from above operation step (1) in order.

⚠ Handling Precautions

- To fasten this controller onto the panel, tighten a mounting bracket screws, and turn one more half turn when there is no play between the bracket and panel. Excessively tightening the screws may deform the controller case.
- If gang-mounted, dustproof and waterproof protection may not be maintained.

● Using the hard cover for panel mount type (C15T)

For panel mounting type, it is possible to attach the hard cover to the front console. Use of hard cover makes it possible to prevent the settings from being changed due to accidental operation or to operate the unit in poor installation environment. The display can be seen with the cover kept closed. When operating the key, raise the cover and operate the key.

Items to be prepared:

Hard cover Part No. 81446442-001 (Optional unit)

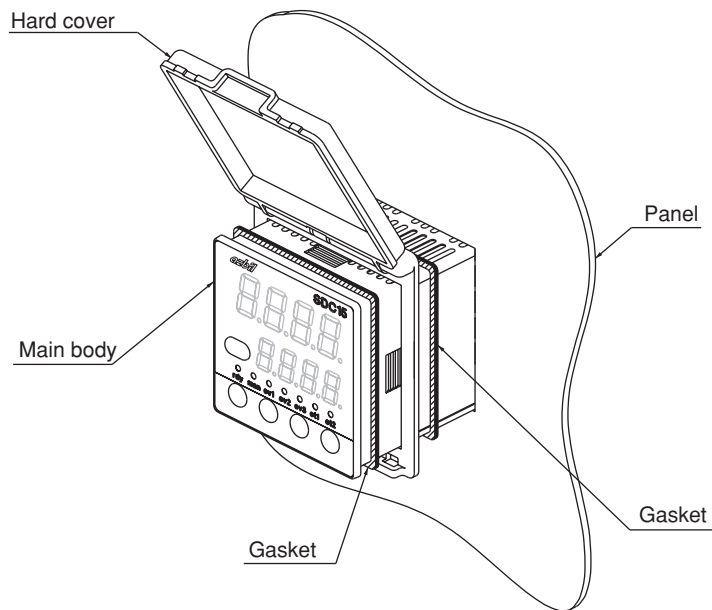

Both gaskets must be used, one is supplied with the main body and the other is supplied with the hard cover. Both are the same gaskets.

- (1) As shown in the Figure, mount the gasket, hard cover, and gasket on the main body in that order so that the hard cover is sandwiched by two gaskets.
- (2) Insert this unit from the front of the panel.
- (3) Fit the mounting bracket from the back of the panel.
- (4) Push the mounting bracket against the panel until the hook of the mounting bracket is firmly engaged with the groove of the main body.
- (5) Tighten the upper and lower screws of the mounting bracket.

❗ Handling Precautions

- To fasten this controller onto the panel, tighten a mounting bracket screws, and turn one more half turn when there is no play between the bracket and panel. Excessively tightening the screws may deform the controller case.
- It is possible to mount this unit without use of two gaskets if the waterproof feature is not needed and only the prevention of improper operation is aimed at.

● Using the soft cover for panel mount type (C15T)

For the panel mounting type, it is possible to attach the soft cover to the front console.

The key can be operated with the soft cover attached.

Attaching the soft cover to the front console provides the protection (IP66) similar to the waterproof mounting using the gasket.

Items to be prepared:

Soft cover Part No. 81446443-001 (Optional unit)

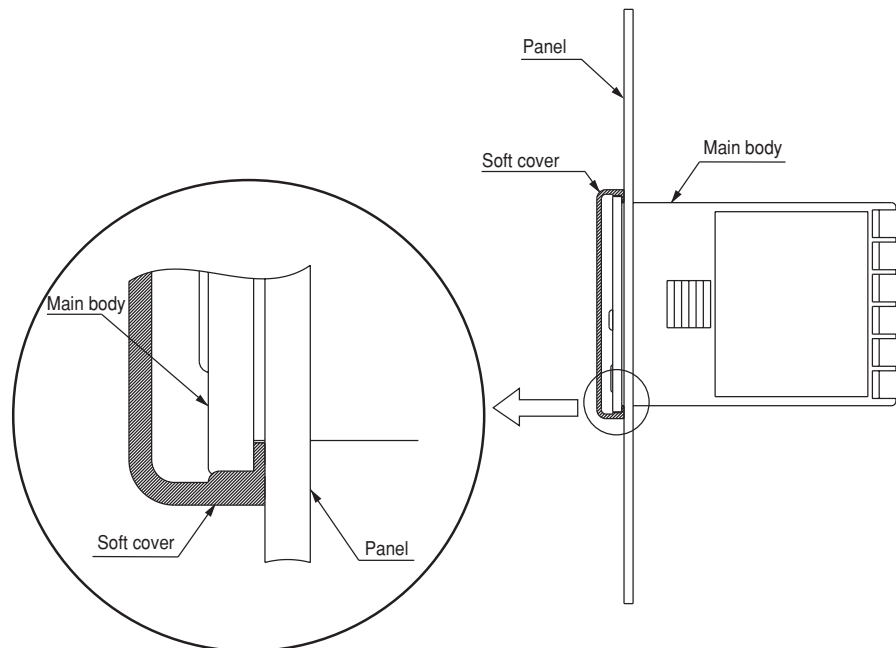

The gasket supplied with the main body is not used.

- (1) Attach the soft cover so that it covers the console of the main body.
- (2) Insert the unit with the soft cover attached from the front of the panel.
- (3) Fit the mounting bracket from the back of the panel.
- (4) Push the mounting bracket against the panel until the hook of the mounting bracket is firmly engaged with the groove of the main body.
- (5) Tighten the upper and lower screws of the mounting bracket.

⚠ Handling Precautions

- To fasten this controller onto the panel, tighten a mounting bracket screws, and turn one more half turn when there is no play between the bracket and panel. Excessively tightening the screws may deform the controller case.
- If gang-mounted, dustproof and waterproof protection may not be maintained.

● **Socket mount type (C15S)**

Items to be prepared:

Phillips-head screwdriver

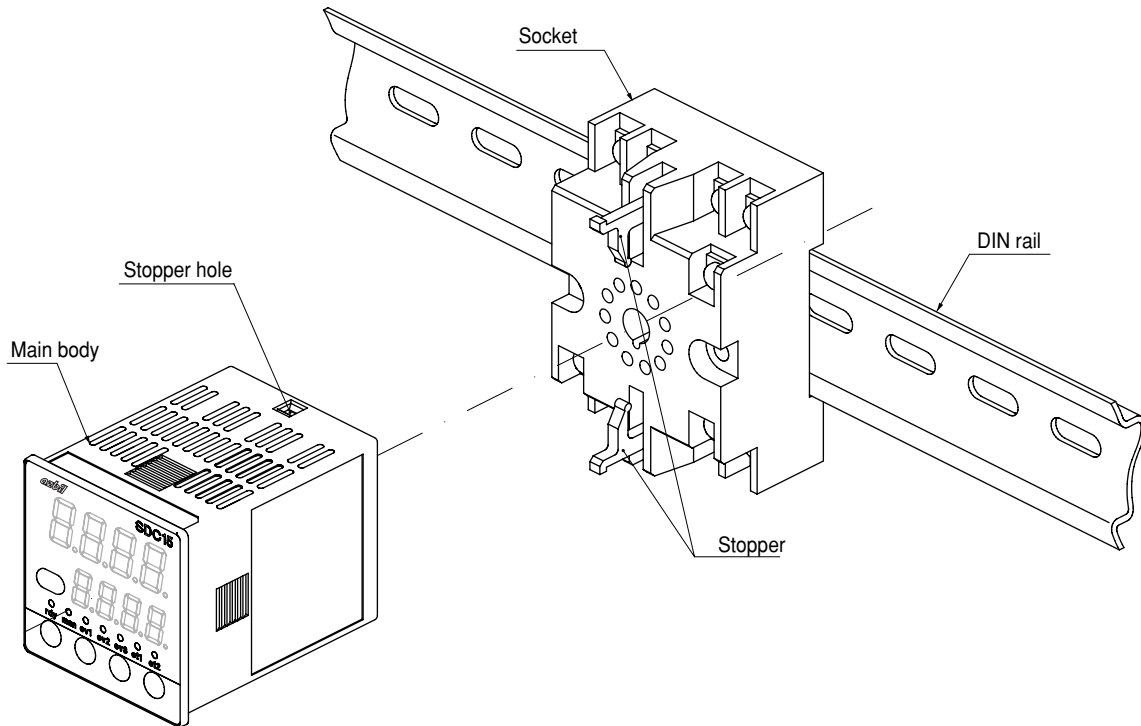

The above Figure shows the DIN rail mounting.

- (1) Mount the socket inside the panel. (For screw tightening, mount the socket directly.)
- (2) Perform the wiring to the socket.
- (3) Push this unit into the socket.
- (4) Put the upper and lower socket stoppers in the stopper holes in the main body, and then insert them.

! Handling Precautions

For socket mount type, it is necessary that the wiring must be completed before mounting this unit on the socket.

Chapter 4. WIRING

4 - 1 Wiring

WARNING



Before wiring, or removing/mounting the SDC15, be sure to turn the power OFF.

Failure to do so might cause electric shock.



Do not touch electrically charged parts such as the power terminals. Doing so might cause electric shock.

CAUTION



Wire the SDC15 properly according to predetermined standards. Also wire the SDC15 using specified power leads according to recognized installation methods.

Failure to do so might cause electric shock, fire or faulty operation.



Do not allow lead clippings, chips or water to enter the controller case. Doing so might cause fire or faulty operation.



Firmly tighten the terminal screws at the torque listed in the specifications. Insufficient tightening of terminal screws might cause electric shock or fire.



Do not use unused terminals on the SDC15 as relay terminals. Doing so might cause electric shock, fire, or faulty operation.



We recommend attaching the terminal cover (sold separately) after wiring the SDC15.

Failure to do so might cause electric shock, fire, or faulty operation.



Continued use of the relays after the recommended service life has expired might cause fire or faulty operation.

Failure to do so might cause fire or faulty operation.



If there is a risk of a power surge caused by lightning, use a surge absorber (surge protector) to prevent fire or device failure.



Do not make incorrect connections. If the cables are connected incorrectly, this might cause the unit to malfunction.



The controller does not function for approximately 6 sec. after the power has been turned ON. Great care should be taken when the relay output from the controller is used as interlock signals.



The part between the control output 1 and control output 2 is not isolated. When necessary, use an appropriate isolator.



Do not connect multiple loader cables to multiple units from one personal computer. The current coming from other circuits might cause the PV value indication error to occur.





Do not connect any terminating resistor to both ends of the communication path when performing the RS-485 wiring. Doing so might cause the communication to fail.



Always mount a switch for shut-down of the main power of this unit in an easily accessible area of the operator when performing electric wiring of this unit. Additionally, connect a slow-action type (T) fuse having a rated current of 0.2A and rated voltage of 250V to the wiring for the instrument power supply of the AC power supply model. (IEC127)

■ Terminal assignment label symbols

The following table shows the meanings of the symbols used for the terminal assignment label attached to the side panel of this unit.

| Symbol | Contents |
|---|--------------------------------|
| ~ | AC |
|  | Caution, Electric shock hazard |
|  | Caution |

■ Wiring Precautions

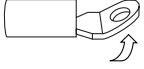
- Before starting the wiring work, carefully check the label on the side panel of this unit to understand the model No. and terminal No. to carry out the wiring properly.
- For panel mount type(C15T), use an appropriate crimp type terminal lug suitable for the M3 screw to connect the terminals. The tightening torque of the terminal screw must be 0.4 to 0.6N·m.
- For socket mount type(C15S), use an appropriate crimp type terminal lug suitable for the M3.5 screw to connect the terminals. The tightening torque of the terminal screw must be 0.78 to 0.98 N·m or less.
- Pay special attention so that no crimp terminals are in contact with adjacent terminals.
- For the C15T (panel-mount type), to connect 2 crimp terminals to the same terminal screw, bend the crimp terminals before use. 
- For the C15T (panel-mount type), connect wires to terminals 1-6 and 13-18 from the left (when viewing the terminal block).

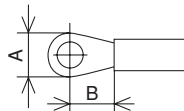

A: 5.8mm max. B: 5.5 to 7.6mm
 Recommended crimp terminal: V1.25-MS3 (manufactured by J.S.T. Mfg. Co., Ltd.)

- Keep the input/output signal cables 50cm or more away from the drive power cable and/or power cable. Additionally, do not pass the input/output signal cables and the drive power cable and/or power cable together through the same conduit or duct.
- When connecting this unit and other measuring instrument in parallel, carefully check the conditions necessary for other instrument before starting the instrumentation.
- The digital input is so designed that it is non-voltage input. A contact for micro current must be used.
- Pass the conductor, to which the heater current flows, through the current transformer. Additionally, carefully check that the heater current does not exceed the allowable current level stated in the specification. If the heater current exceeds the allowable current level, this might cause damage to this unit.
- The input of the current transformer cannot be used for the phase angle control.
- For panel mounting type (C15T), an optional terminal cover is available to prevent electric shock. (Model No.: 81446898-001)

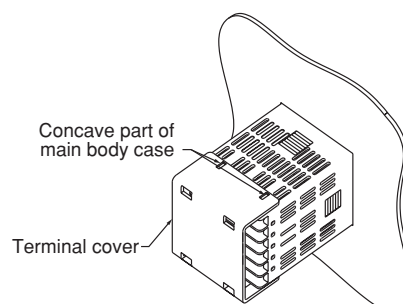

Important

- The part between the control output 1 and control output 2 is not isolated. When necessary, use an appropriate isolator.
- Do not connect any terminating resistor to both ends of the RS-485 communication path. Doing so might cause the communication to fail.
- Make sure that devices and equipment connected to this device have reinforced insulation suitable for the maximum operating voltage of this device's power supply and input/output ports.
- This unit is so designed that it does not start functioning for up to 6 sec. after the power has been turned ON to ensure stable operation. After 6 sec. have elapsed, the unit enters the operation mode. However, to obtain the specified accuracy, it is absolutely necessary to warm up the unit for 30 min. or longer.

● **Wiring of C15T**

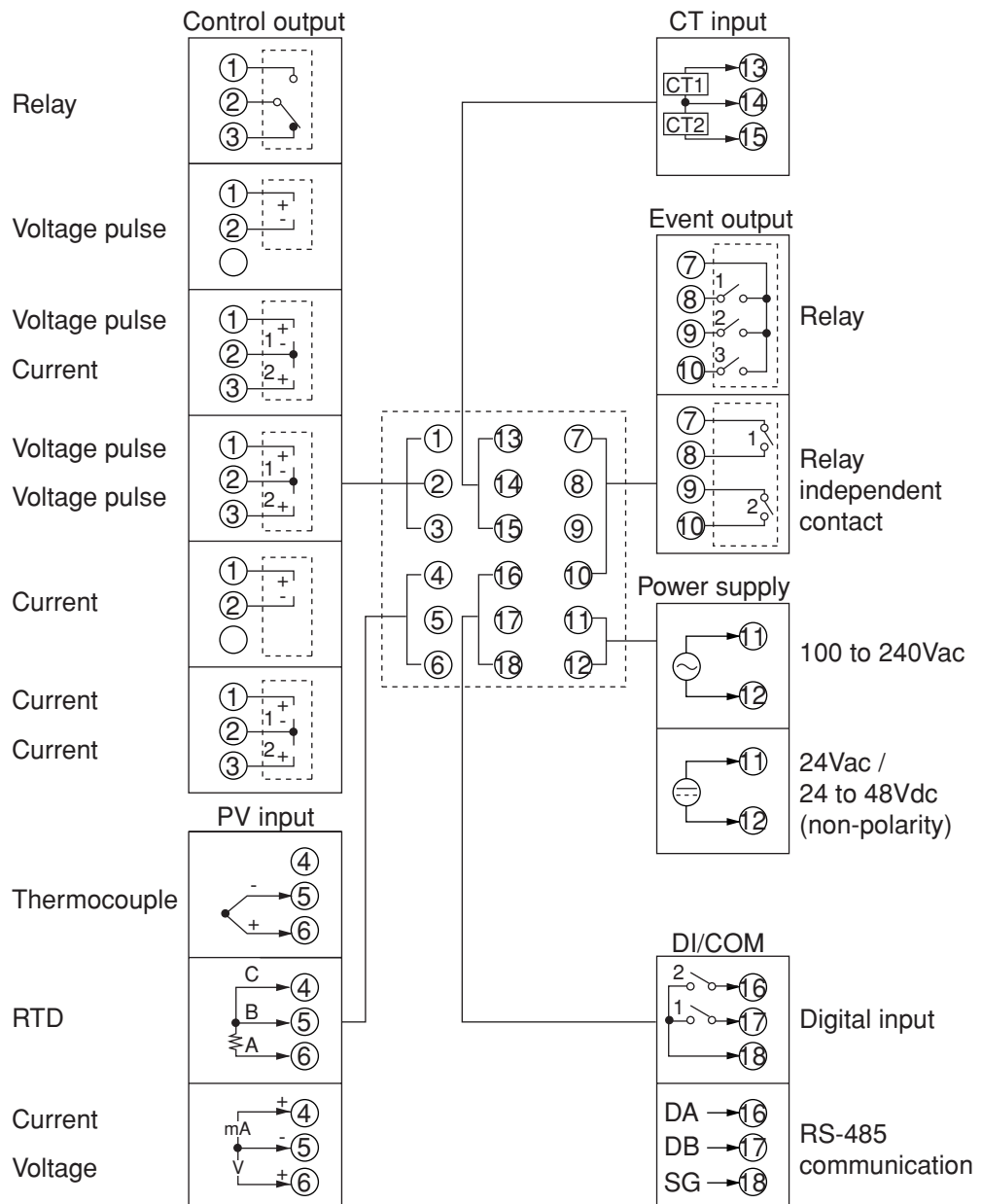

● Wiring of C15S

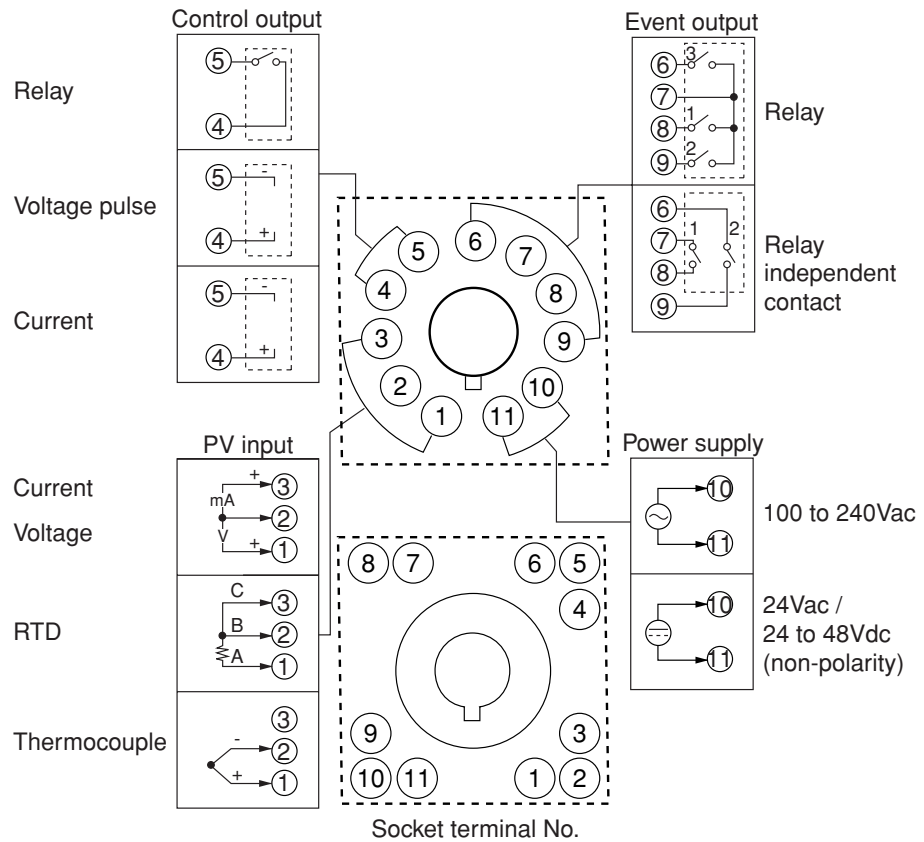

● Recommended crimp type terminal lugs

For C15T, use an appropriate crimp type terminal lug suitable for the M3 screw.
 For C15S socket mounting type, use an appropriate crimp type terminal lug suitable for the M3.5 screw.

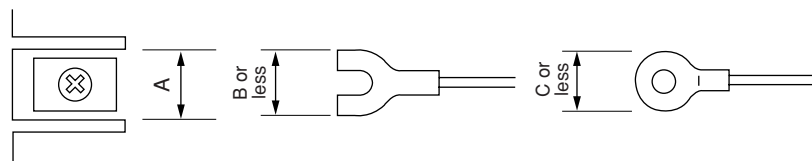

| Mounting method | Applicable screw | Terminal dimensions (mm) | | | Recommended crimp terminal JIS indication | Applicable electric wire size | J.S.T. Mfg. Co. Ltd Model No. (Reference) |
|---------------------------|------------------|--------------------------|-----|-----|---|--|---|
| | | A | B | C | | | |
| C15T panel mounting type | M3 | 6.1 | 5.8 | 5.8 | RAV1.25 - 3 | 0.3 to 1.2mm ² AWG22 to 16 | V1.25 - 3 V1.25 B3A |
| C15S socket mounting type | M3.5 | 7.4 | 6.4 | 6.6 | RAV1.25 - 3.5 | 0.3 to 1.2mm ² AWG22 to 16 | V1.25 - M3 V1.25 YS3A |

! Handling Precautions

- When installing this unit in a place where the vibration or impact is large, always use an appropriate round crimp terminal so that it is not disengaged from the connection terminal.
- Pay special attention so that no crimp terminals are in contact with adjacent terminals.

■ Connection of open collector output to digital input

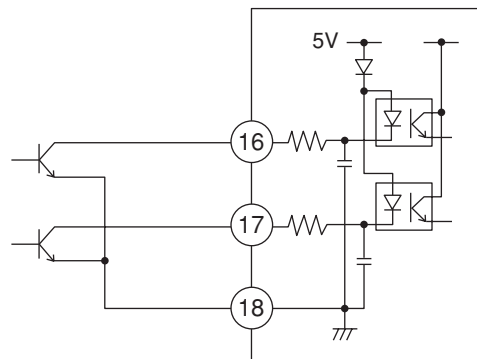

■ Connection of (RS-485) communication cable

● 3-wire system

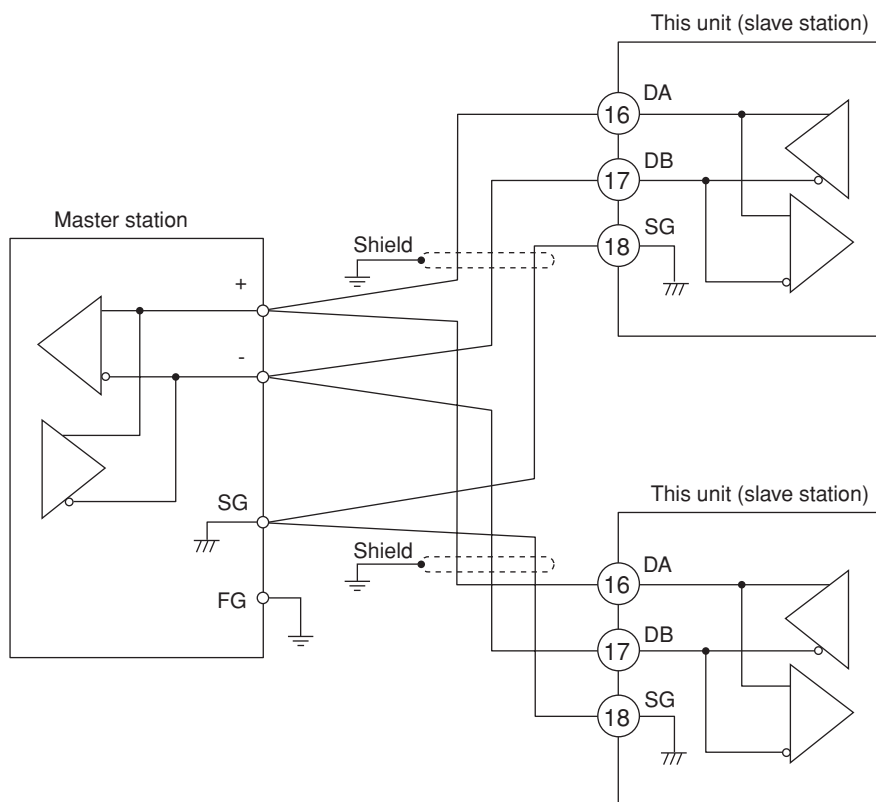

Important

! Handling Precautions

- Do not connect any terminating resistor to both ends of the communication path. Doing so might cause the communication to fail.
- Even though any units requiring the terminating resistor exist in the communication path, do not connect any terminating resistor.
- Do not connect DA and DB. Doing so might cause damage to this unit.
- Ground the shield line to one point on one side of the cable.
- Be sure to connect SG terminals each other. Failure to do so might cause unstable communications.

● 5-wire system

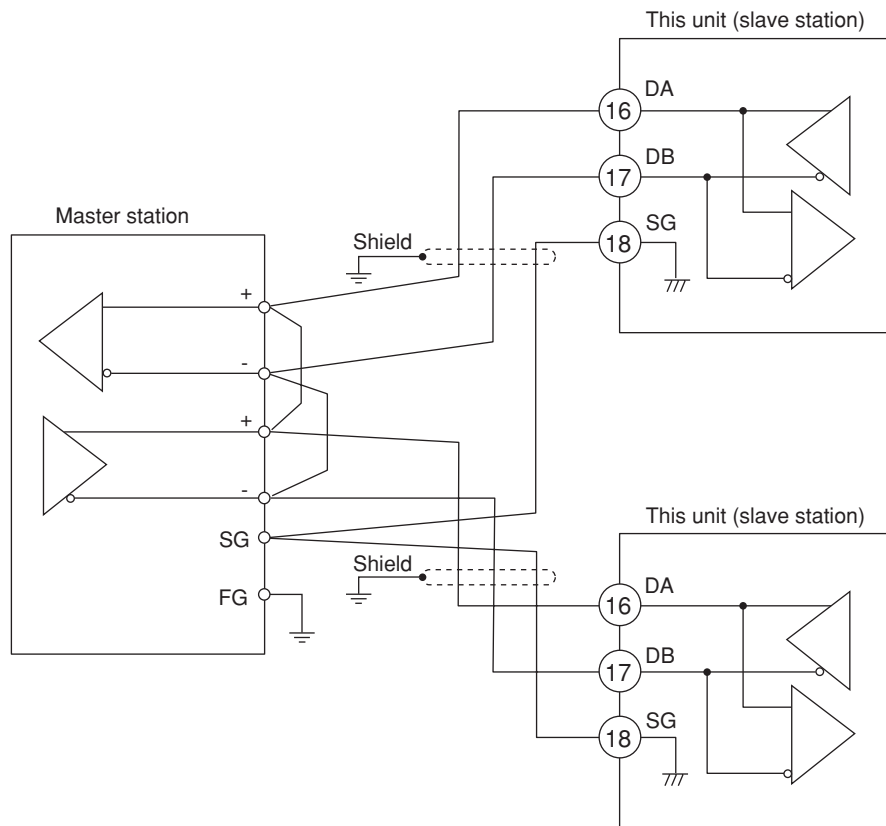

Important

! Handling Precautions

- Do not connect any terminating resistor to both ends of the communication path. Doing so might cause the communication to fail.
- Even though any units requiring the terminating resistor exist in the communication path, do not connect any terminating resistor.
- Do not connect DA and DB. Doing so might cause damage to this unit.
- Ground the shield line to one point on one side of the cable.
- Be sure to connect SG terminals each other. Failure to do so might cause unstable communications.

■ Connection with SSR (solid state relay)

To drive the SSR, a model having voltage pulse outputs (control output code is V0, VC, or VV) must be used.

Generally, the SSR is classified into two groups, constant current type and resistor type. The following describes how to connect each type.

● Constant current type

The following specifications of the SSR you are using and the specifications of the voltage pulse output must be investigated:

- Input current (maximum): When the input current is the maximum allowable current or less, the parallel connection can be made.
- Operating voltage range (input): Check that the voltage between the terminals of the voltage pulse output is within the specified range.

1. Azbil Corporation's PGM10N/PGM10F series

This example shows the calculation for the connection of the SDC15 and the PGM10N015.

(Note: For connection with other model number, check the specifications of each model.)

- Input current: Since the input current is 10mA or less, up to two units ($10\text{mA} \times 2 = 20\text{mA} < 24\text{mA}$ [maximum allowable current]) can be connected in parallel.
- Operating voltage range (input): The rating voltage is 3.5 to 30Vdc. Therefore, the voltage between the terminals is within the range.

Voltage between terminals (two PGM10N units)

$$\begin{aligned}
 &= \text{Open voltage} - \text{internal resistance} \times \text{total drive current} \\
 &= 19\text{Vdc} \pm 15\% - 82\Omega \pm 0.5\% \quad \times 20\text{mA} \\
 &\approx 15 \text{ to } 20\text{V}
 \end{aligned}$$

Connection diagram

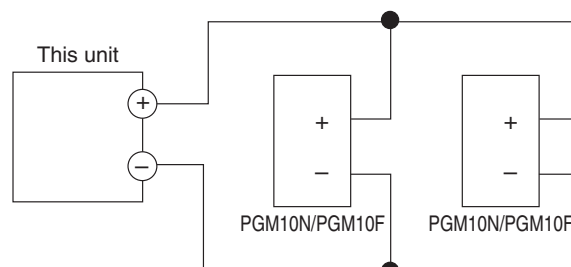

Number of connectable units

| SSR to be used | Connection | V0/VC model | VV model |
|--------------------------|---------------------|---------------|----------------------|
| Azbil Corporation PGM10N | Parallel connection | Up to 2 units | Up to 4 units (Note) |
| Azbil Corporation PGM10F | Parallel connection | Up to 2 units | Up to 4 units (Note) |

(Note) 2 units for each output

2. Omron's G3PA, G3PB, G3NA

- Input current: Since the input current is 7mA or less, up to three units (7mA X 3 = 21mA < 24mA [maximum allowable current]) can be connected in parallel.
- Operating voltage range (input): The rating voltage is 5 to 24Vdc or 12 to 24Vdc. Therefore, the voltage between the terminals is within the range.

Voltage between terminals (three G3PA units)
 = Open voltage - internal resistance X total drive current
 = 19Vdc ±15% - 82Ω ±0.5% X 21mA
 ≈ 14 to 20V

Connection diagram

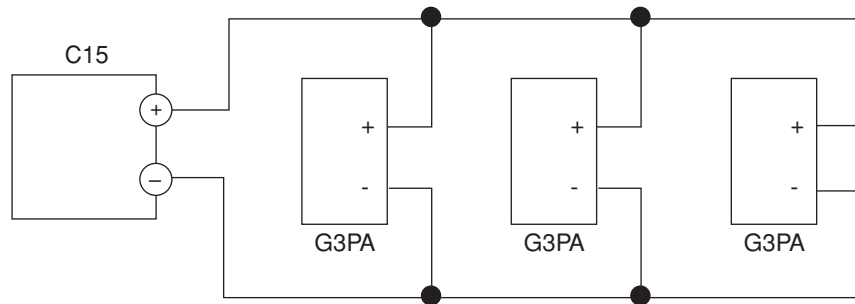

Number of connectable units

| SSR to be used | Connection | V0 model | VV model |
|----------------|---------------------|---------------|----------------------|
| Omron G3PA | Parallel connection | Up to 3 units | Up to 6 units (Note) |
| Omron G3PB | Parallel connection | Up to 3 units | Up to 6 units (Note) |
| Omron G3NA | Parallel connection | Up to 3 units | Up to 6 units (Note) |

(Note) 3 units for each output

● Resistor type (Azbil Corporation's PGM, etc.)

When necessary, an appropriate external resistor is connected in series so that the voltage between the input terminals of the SSR you are using is within the specified range.

(Example) Connection of two Azbil Corporation PGM units

Connection diagram

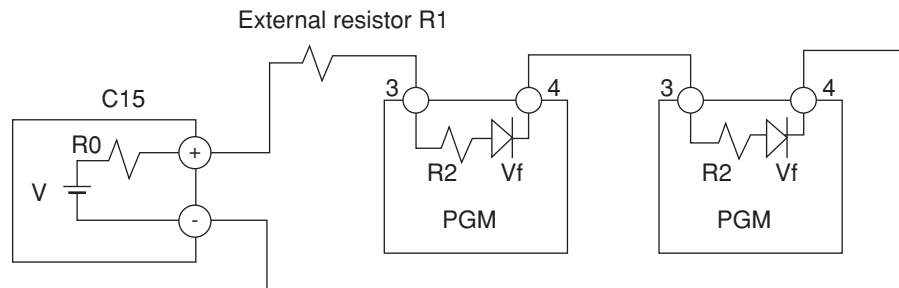

V: 19V ± 15%

R0: 82Ω ± 0.5%

R1: 680 Ω

R2: 260 Ω

Vf: 1.1V

$$\text{Voltage between terminals of PGM} = (V - 2 \times Vf) / (R0 + R1 + R2 + R2) \times R2 + Vf \approx 4.5 \text{ V}$$

Input voltage range of PGM: Since the input voltage range is 3 to 6V, the operation is possible.

External resistors

| SSR to be used | Number of units to be connected | Connection | External resistor | Notes |
|-----------------------|---------------------------------|-------------------|--------------------------|-------------------------|
| Azbil Corporation PGM | 1 | — | 1kΩ (serial connection) | Rating is 1/2W or more. |
| | 2 | Serial connection | 680Ω (serial connection) | Rating is 1/2W or more. |
| | 3 | Serial connection | 330Ω (serial connection) | Rating is 1/2W or more. |
| | 4 | Serial connection | None | |

Number of connectable units

| SSR to be used | Connection | V0 model | VV model |
|-----------------------|-------------------|---------------|----------------------|
| Azbil Corporation PGM | Serial connection | Up to 4 units | Up to 8 units (Note) |

(Note) 4 units for each output

■ Noise Preventive Measures

The power is taken from the single-phase instrumental power supply to consider noise preventive measures.

If the noise from the power supply is large, an appropriate insulation transformer is added to the power supply and an appropriate line filter is used.

(Azbil Corporation's line filter model No.: 81442557-001)

If the noise has fast rising edge, an appropriate CR filter is used.

(Azbil Corporation's CR filter model No.: 81446365-001)

⚠ Handling Precautions

After the noise preventive measures have been taken, do not bundle the primary and secondary sides of the insulation transformer together or put them in the same conduit or duct.

4 - 2 Recommended Cables

Contact the thermocouple wires to the terminals in case of a thermocouple input. When a thermocouple is connected to terminals, or wiring distance is long, connect the wire via a shielded compensating lead wire.

- For input/output other than thermocouples, use a JCS 4364 instrument cable or equivalent (generally called twisted shielded cable for instrumentation use).

Recommended twisted shielded cables.

| | | |
|-------------------|--------------|--------------------------------|
| Fujikura Ltd. | 2 conductors | IPEV-S-0.9mm ² X 1P |
| | 3 conductors | ITEV-S-0.9mm ² X 1T |
| Hitachi Cable Co. | 2 conductors | KPEV-S-0.9mm ² X 1P |
| | 3 conductors | KTEV-S-0.9mm ² X 1T |

- A shielded multiconductor microphone cord (MVVS) may be used, if electromagnetic induction noise are comparatively low.

Chapter 5. SETTINGS BEFORE STARTING OPERATION

CAUTION



Do not operate the key with a propelling pencil or sharp-tipped object. Doing so might cause faulty operation.

5 - 1 PV Input

The PV input type, temperature unit, decimal point position, and PV input range low limit and high limit of the PV input are set.

There may be some items you cannot set up depending on the input type (T: Thermocouple, R: RTD, L: DC current or DC voltage) or PV range type of the model.

■ PV range type setup

- (1) In the operation display mode, keep the [para] key pressed for 2 sec. or longer.
>> The unit then enters the parameter setting mode.

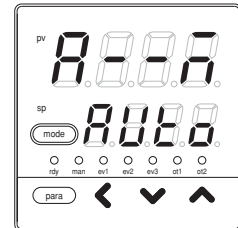

- (2) In the parameter setting display mode, keep the [para] key pressed for 2 sec. or longer.
>> The display is then changed to the setup setting display. The setup setting [C01: PV input type] is displayed first.

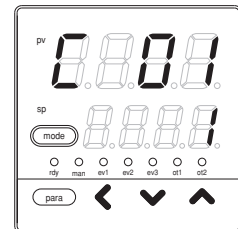

- (3) Press the [<], [v], or [^] key to select a desired C01 No.
Set the value set in [C01] to the range No. you have selected from the following input range table.
>> The range No. starts flashing.
>> When no keys are pressed for 2 sec. or longer, the flashing of the numeric value is stopped to set the currently displayed value.
- (4) Press the [mode] key.
>> The display is returned to the operation display.

● PV input range table (Thermocouple)

| C01 set value | Sensor type | Range (Celsius) | Range (Fahrenheit) | C04 display | C04 range | C04 initial value when C01 settings |
|---------------|-------------|--------------------|--------------------|-------------|---------------|-------------------------------------|
| 1 | K | -200 to +1200°C | -300 to + 2200°F | ---- | (Not setting) | (No decimal point) |
| 2 | K | 0 to 1200°C | 0 to 2200°F | ---- | (Not setting) | (No decimal point) |
| 3 | K | 0.0 to 800.0°C | 0 to 1500°F | ○ | 0 to 1 | 0 |
| 4 | K | 0.0 to 600.0°C | 0 to 1100°F | ○ | 0 to 1 | 0 |
| 5 | K | 0.0 to 400.0°C | 0 to 700°F | ○ | 0 to 1 | 0 |
| 6 | K | -200.0 to +400.0°C | -300 to + 700°F | ○ | 0 to 1 | 0 |
| 9 | J | 0.0 to 800.0°C | 0 to 1500°F | ○ | 0 to 1 | 0 |
| 10 | J | 0.0 to 600.0°C | 0 to 1100°F | ○ | 0 to 1 | 0 |
| 11 | J | -200.0 to +400.0°C | -300 to + 700°F | ○ | 0 to 1 | 0 |
| 13 | E | 0.0 to 600.0°C | 0 to 1100°F | ○ | 0 to 1 | 0 |
| 14 | T | -200.0 to +400.0°C | -300 to + 700°F | ○ | 0 to 1 | 0 |
| 15 | R | 0 to 1600°C | 0 to 3000°F | ---- | (Not setting) | (No decimal point) |
| 16 | S | 0 to 1600°C | 0 to 3000°F | ---- | (Not setting) | (No decimal point) |
| 17 | B | 0 to 1800°C | 0 to 3300°F | ---- | (Not setting) | (No decimal point) |
| 18 | N | 0 to 1300°C | 0 to 2300°F | ---- | (Not setting) | (No decimal point) |
| 19 | PL II | 0 to 1300°C | 0 to 2300°F | ---- | (Not setting) | (No decimal point) |
| 20 | WRe5-26 | 0 to 1400°C | 0 to 2400°F | ---- | (Not setting) | (No decimal point) |
| 21 | WRe5-26 | 0 to 2300°C | 0 to 4200°F | ---- | (Not setting) | (No decimal point) |
| 23 | PR40-20 | 0 to 1900°C | 0 to 3400°F | ---- | (Not setting) | (No decimal point) |
| 24 | DIN U | -200.0 to +400.0°C | -300 to + 700°F | ○ | 0 to 1 | 0 |
| 25 | DIN L | -100.0 to +800.0°C | -150 to + 1500°F | ○ | 0 to 1 | 0 |

● PV input range table (RTD)

| C01 set value | Sensor type | Range (Celsius) | Range (Fahrenheit) | C04 display | C04 range | C04 initial value when C01 settings |
|---------------|-------------|--------------------|--------------------|-------------|---------------|-------------------------------------|
| 41 | Pt100 | -200.0 to +500.0°C | -300 to + 900°F | ---- | (Not setting) | (No decimal point) |
| 42 | JPt100 | -200.0 to +500.0°C | -300 to + 900°F | ---- | (Not setting) | (No decimal point) |
| 43 | Pt100 | -200.0 to +200.0°C | -300 to + 400°F | ---- | (Not setting) | (No decimal point) |
| 44 | JPt100 | -200.0 to +200.0°C | -300 to + 400°F | ---- | (Not setting) | (No decimal point) |
| 45 | Pt100 | -100.0 to +300.0°C | -150 to + 500°F | ---- | (Not setting) | (No decimal point) |
| 46 | JPt100 | -100.0 to +300.0°C | -150 to + 500°F | ---- | (Not setting) | (No decimal point) |
| 51 | Pt100 | -50.0 to +200.0°C | -50 to + 400°F | ○ | 0 to 1 | 1 |
| 52 | JPt100 | -50.0 to +200.0°C | -50 to + 400°F | ○ | 0 to 1 | 1 |
| 53 | Pt100 | -50.0 to +100.0°C | -50 to + 200°F | ○ | 0 to 1 | 1 |
| 54 | JPt100 | -50.0 to +100.0°C | -50 to + 200°F | ○ | 0 to 1 | 1 |
| 63 | Pt100 | 0.0 to 200.0°C | 0 to + 400°F | ○ | 0 to 1 | 1 |
| 64 | JPt100 | 0.0 to 200.0°C | 0 to + 400°F | ○ | 0 to 1 | 1 |
| 67 | Pt100 | 0.0 to 500.0°C | 0 to + 900°F | ---- | (Not setting) | (No decimal point) |
| 68 | JPt100 | 0.0 to 500.0°C | 0 to + 900°F | ---- | (Not setting) | (No decimal point) |

*1. Accuracy of sensor type B (No.17): ±5%FS below 260°C, ±1%FS from 260 to 800°C, not specified below 20°C
 However, if ROM version 1 in the instrument information bank (i 202) is 2.04 or earlier, the low limit for display is -180°C.

Accuracy of sensor type PR40-20 (No.23): not specified below 300°C, ±5%FS from 300 to 800°C, ±2%FS from 800 to 1900°C

However, if ROM version 1 in the instrument information bank (i 202) is 2.26 or earlier, No.23 cannot be selected.

*2. PL II thermocouple is a range, which has been added to the units manufactured from July, 2003.

*3. The PV range display for thermocouple with a decimal point is available for ROM version 2.26 and later.

● PV input range table (DC voltage/DC current)

| C01 set value | Sensor type | Range (C05, C06) | C04 display | C04 range | C04 initial value when C01 settings |
|---------------|-------------|--|-------------|-----------|-------------------------------------|
| 84 | 0 to 1V | • Scaling range is -1999 to +9999. • When C01 is changed, the range (C05, C06) defaults to 0 to 1000. | ○ | 0 to 3 | No change |
| 86 | 1 to 5V | | ○ | 0 to 3 | No change |
| 87 | 0 to 5V | | ○ | 0 to 3 | No change |
| 88 | 0 to 10V | | ○ | 0 to 3 | No change |
| 89 | 0 to 20mA | | ○ | 0 to 3 | No change |
| 90 | 4 to 20mA | | ○ | 0 to 3 | No change |

! Handling Precautions

- When the C01 PV input range number is set, the decimal point position and range are initially set automatically as shown in the tables. For details on the decimal point, refer to;
 - ➔ SDC15 Single Loop Controller User's Manual for Installation & Configuration CP-SP-1148E.
- Make sure to set the correct number in setup display C01, according to the type and range of the sensor used. If the setting is wrong, problems such as large temperature errors in the output may occur.
- For details about the accuracy of each PV range type, refer to;
 - ➔ Chapter 11, SPECIFICATIONS (on page 11-1).

■ Temperature unit setup

(1) In the operation display mode, keep the [para] key pressed for 2 sec. or longer.

>> The unit then enters the parameter setting mode.

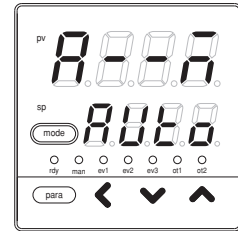

(2) In the parameter setting display mode, keep the [para] key pressed for 2 sec. or longer.

>> The display is then changed to the setup setting display.

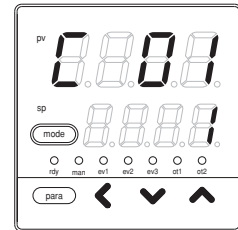

(3) Press the [para] key.

>> The setup setting [C02: Temperature unit] is displayed.

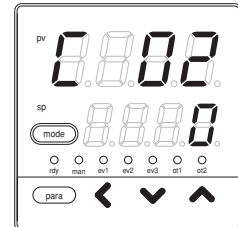

(4) Press the [<], [v], or [^] key to set the value you have selected from the following in [C02].

0: Centigrade (°C)

1: Fahrenheit (°F)

>> When no keys are pressed for 2 sec. or longer, the flashing of the numeric value is stopped to set the currently displayed value.

(5) Press the [mode] key.

>> The display is returned to the operation display.

! Handling Precautions

When the input type of the model is "T: Thermocouple" or "R: RTD", [C02: Temperature unit] can be displayed. However, when the input type is "L: DC current or DC voltage", [C02] cannot be displayed.

■ Decimal point position setup

(1) In the operation display mode, keep the [para] key pressed for 2 sec. or longer.

>> The unit then enters the parameter setting mode.

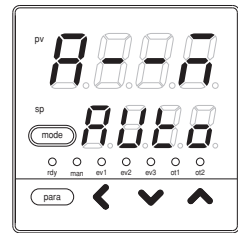

(2) In the parameter setting display mode, keep the [para] key pressed for 2 sec. or longer.

>> The display is then changed to the setup setting display.

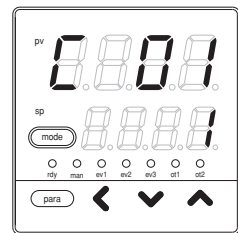

(3) Press the [para] key several times.

>> Display the setup setting [C04:Decimal point position].

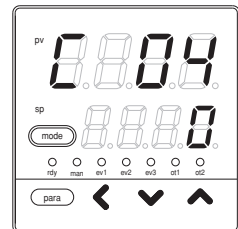

(4) Press the [<], [v], or [^] key to set the value you have selected from the following in [C04].

- 0: No decimal point
- 1: 1 digit after decimal point
- 2: 2 digits after decimal point
- 3: 3 digits after decimal point

>> When no keys are pressed for 2 sec. or longer, the flashing of the numeric value is stopped to set the currently displayed value.

(5) Press the [mode] key.

>> The display is returned to the operation display.

! Handling Precautions

[C04: Decimal point position] can be displayed only when the PV input of the model is “L: DC current or DC voltage input” or “T: Thermocouple”, “R: RTD”, and the range shown in the PV input range table on page 5-3 has the decimal point.

■ PV input range low limit/high limit setup

(1) In the operation display mode, keep the [para] key pressed for 2 sec. or longer.

>> The unit then enters the parameter setting mode.

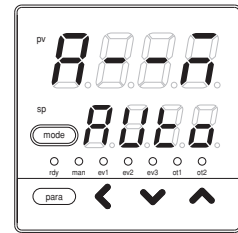

(2) In the parameter setting display mode, keep the [para] key pressed for 2 sec. or longer.

>> The display is then changed to the setup setting display.

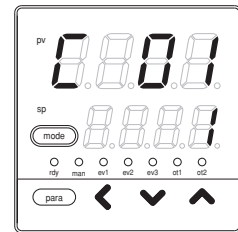

(3) Press the [para] key several times.

>> Display the setup setting, [C05: PV input range low limit] or [C06: PV input range high limit].

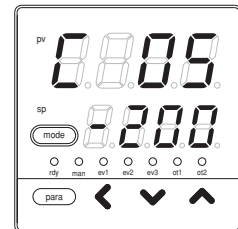

(4) Press the [<], [v], or [^] key to change the set value in [C05] or [C06].

Setting range:

- 1999 to +9999 (no decimal point)
- 199.9 to +999.9 (1 digit after decimal point)
- 19.99 to +99.99 (2 digits after decimal point)
- 1.999 to +9.999 (3 digits after decimal point)

>> When no keys are pressed for 2 sec. or longer, the flashing of the numeric value is stopped to set the currently displayed value.

(5) Press the [mode] key.

>> The display is returned to the operation display.

The following describes the relationship between the PV input and PV when setting up the range low limit and high limit:

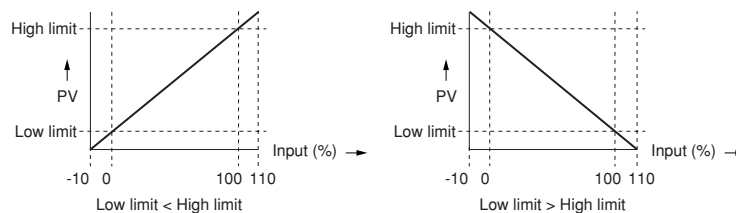

! Handling Precautions

When the input type of the model is “L: DC current or DC voltage”, [C05: PV input range low limit] and [C06: PV input range high limit] can be set. When the input type is “T: Thermocouple” or “R: RTD”, the setup item is displayed, but the set value cannot be changed.

5 - 2 Control

The control method, control action (Direct/Reverse), heat/cool control selection, and heat/cool control deadband are set.

■ Control method setup

- (1) In the operation display mode, keep the [para] key pressed for 2 sec. or longer.
>> The unit then enters the parameter setting mode.

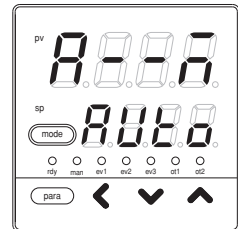

- (2) Press the [para] key several times to display the parameter setting [Ctrl: Control method].
>> The operation enters the [Control method] selection mode.

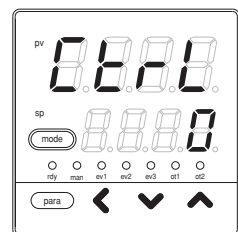

- (3) Press the [<], [v], or [^] key to set the value you have selected from the following in [Ctrl].

- 0: ON/OFF control
- 1: Fixed PID
- 2: ST (Self-tuning)

>> When no keys are pressed for 2 sec. or longer, the flashing of the numeric value is stopped to set the currently displayed value.

- (4) Press the [mode] key.
The display is returned to the operation display.

! Handling Precautions

When using the ST (Self-tuning) function,

☞ refer to 8-2 ST (Self-tuning) Functions (on page 8-4) and 8-3 Precautions for ST (Self-tuning) (on page 8-6).

■ Control action (Direct/Reverse) setup

(1) In the operation display mode, keep the [para] key pressed for 2 sec. or longer.

>> The unit then enters the parameter setting mode.

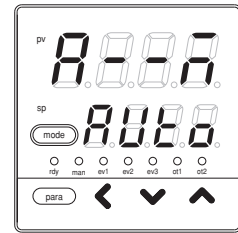

(2) In the parameter setting display mode, keep the [para] key pressed for 2 sec. or longer.

>> The display is then changed to the setup setting display.

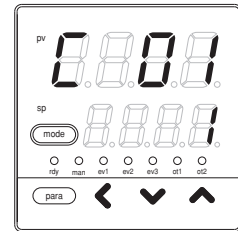

(3) Press the [para] key several times.

>> Display the setup setting [C14:Control action (Direct/Reverse)].

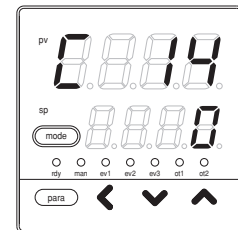

(4) Press the [<], [v], or [^] key to set the value you have selected from the following in [C14].

0: Reverse action (Heat control)

1: Direct action (Cool control)

>> When no keys are pressed for 2 sec. or longer, the flashing of the numeric value is stopped to set the currently displayed value.

(5) Press the [mode] key.

>> The display is returned to the operation display.

ⓘ Handling Precautions

- When the setup setting [C26: Heat/cool control selection] is set at [1: Enabled], [C14] is not displayed.
- The reverse action (heat control) means that the MV (manipulated variable) is decreased (or turned OFF) as the PV value increases. The direct action (cool control) means that the MV (manipulated variable) is increased (or turned ON) as the PV value increases.

■ Heat/Cool control selection setup

- (1) In the operation display mode, keep the [para] key pressed for 2 sec. or longer.

>> The unit then enters the parameter setting mode.

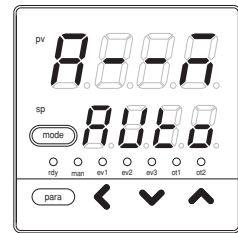

- (2) In the parameter setting display mode, keep the [para] key pressed for 2 sec. or longer.

>> The display is then changed to the setup setting display.

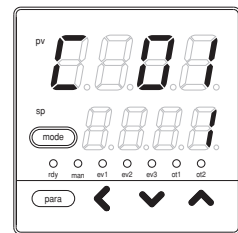

- (3) Press the [para] key several times.

>> Display the setup setting [C26: Heat/Cool control selection].

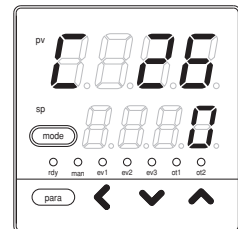

- (4) Press the [<], [v], or [^] key to set the value you have selected from the following in [C26].

0: Disabled

1: Enabled

>> When no keys are pressed for 2 sec. or longer, the flashing of the numeric value is stopped to set the currently displayed value.

- (5) Press the [mode] key.

The display is returned to the operation display.

ⓘ Handling Precautions

- When the control output is one point and the event output is not used, [C26] is not displayed.
- If it is necessary to perform the heat/cool control with [C26] set at "1" when the control output is one point, the setup mode is changed to "High function configuration" and 2nd output must be set to the event with DO assignments.
- When the parameter setting [Ctrl: Control method] is set at [0: ON/OFF control], [C26] is not displayed.

■ Heat/Cool control dead band setup

(1) In the operation display mode, keep the [para] key pressed for 2 sec. or longer.

>> The unit then enters the parameter setting mode.

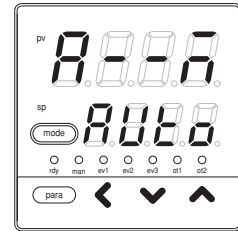

(2) In the parameter setting display mode, keep the [para] key pressed for 2 sec. or longer.

>> The display is then changed to the setup setting display.

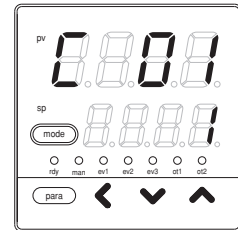

(3) Press the [para] key several times.

>> Display the setup setting [C28: Heat/Cool control dead band].

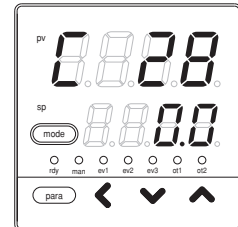

(4) Press the [<], [v], or [^] key to change the set value in [C28].

Setting range: -100.0 to +100.0 (%)

>> When no keys are pressed for 2 sec. or longer, the flashing of the numeric value is stopped to set the currently displayed value.

(5) Press the [mode] key.

>> The display is returned to the operation display.

C28: The following shows the relationship among the MV (manipulated variable) in the heat/cool control dead band, MV (manipulated variable) (heat), and MV (manipulated variable) (cool).

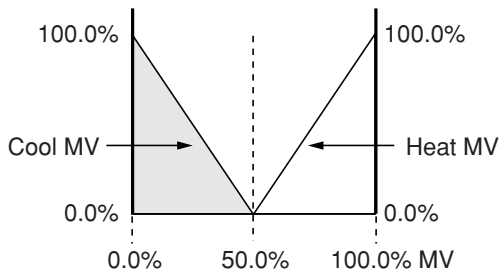

Figure 1.
Deadband = 0.0 %
Heat/cool control change point = 50.0 %

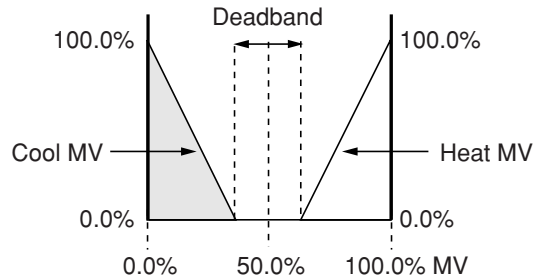

Figure 2.
Deadband > 0.0 %
Heat/cool control change point = 50.0 %

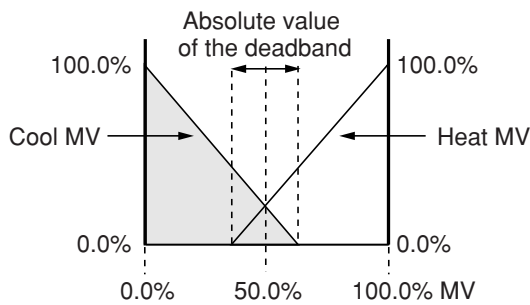

Figure 3.
Deadband < 0.0 %
Heat/cool control change point = 50.0 %

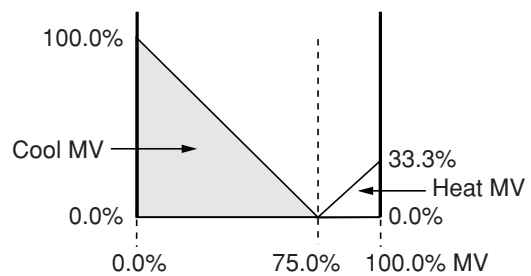

Figure 4.
Deadband = 0.0 %
Heat/cool control change point = 75.0 %

SDC15 Single Loop Controller User's Manual for Installation & Configuration,
No. CP-SP-1148E (13th edition or later)

! Handling Precautions

- When the parameter setting [Ctrl: Control method] is set at [0: ON/OFF control], [C28] is not displayed.
- When the control output is one point and the event output is not used, [C28] is not displayed.
- When the setup setting [C26: Heat/Cool control selection] is set at [0: Disabled], [C28] is not displayed.

■ LSP system group setup

- (1) In the operation display mode, keep the [para] key pressed for 2 sec. or longer.

>> The unit then enters the parameter setting mode.

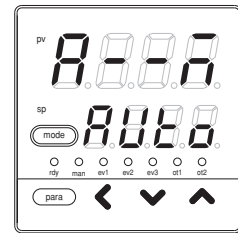

- (2) In the parameter setting display mode, keep the [para] key pressed for 2 sec. or longer.

>> The display is then changed to the setup setting display.

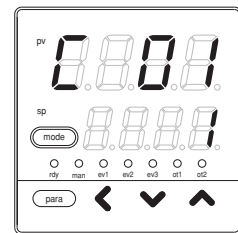

- (3) Press the [para] key several times.

>> Display the setup setting [C30: LSP system group].

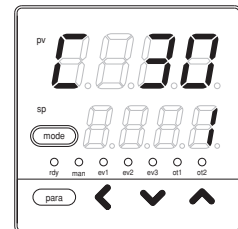

- (4) Press the [<], [v], or [^] key to change the set value in [C30].

Setting range: 1 to 4

>> When no keys are pressed for 2 sec. or longer, the flashing of the numeric value is stopped to set the currently displayed value.

- (5) Press the [mode] key.

>> The display is returned to the operation display.

5 - 3 Internal Event

In "Simple configuration", the internal event must be set when using the event output, an additional function of the model. In "Simple configuration", the operation type, Direct/Reverse, standby, MV in READY mode, main setting, and sub-setting of the internal event can be set. With the default settings before shipment, the internal event process has been connected directly to the event output. Therefore, the optional event output of the model is operated only with the internal event setting.

The following describes the event operation.



For details about U (unit), refer to the attached glossary.

| Operation type | Set value of operation type | Direct action ● shows that the ON/OFF is changed at this value. ○ shows that the ON/OFF is changed at a point that "1U" is added to this value. | Reverse action ● shows that the ON/OFF is changed at this value. ○ shows that the ON/OFF is changed at a point that "1U" is added to this value. |
|---|-----------------------------|--|---|
| No event | 0 | Always OFF | Always OFF |
| PV high limit | 1 | | |
| PV low limit | 2 | | |
| PV high/low limit | 3 | | |
| Deviation high limit | 4 | | |
| Deviation low limit | 5 | | |
| Deviation high/low limit | 6 | | |
| Deviation high limit (Final SP reference) | 7 | Same as the direct action of the deviation high limit. (The difference is that the SP ramp does not use the current SP, but it uses the final SP.) | Same as the reverse action of the deviation high limit. (The difference is that the SP ramp does not use the current SP, but it uses the final SP.) |
| Deviation low limit (Final SP reference) | 8 | Same as the direct action of the deviation low limit. (The difference is that the SP ramp does not use the current SP, but it uses the final SP.) | Same as the direct action of the deviation low limit. (The difference is that the SP ramp does not use the current SP, but it uses the final SP.) |
| Deviation high/low limit (Final SP reference) | 9 | Same as the direct action of the deviation high/low limit. (The difference is that the SP ramp does not use the current SP, but it uses the final SP.) | Same as the reverse action of the deviation high/low limit. (The difference is that the SP ramp does not use the current SP, but it uses the final SP.) |
| SP high limit | 10 | | |

Chapter 5. SETTINGS BEFORE STARTING OPERATION

| Operation type | Set value of operation type | Direct action ● shows that the ON/OFF is changed at this value. ○ shows that the ON/OFF is changed at a point that "1U" is added to this value. | Reverse action ● shows that the ON/OFF is changed at this value. ○ shows that the ON/OFF is changed at a point that "1U" is added to this value. |
|--------------------------------|-----------------------------|---|--|
| SP low limit | 11 | <p>Main setting</p> <p>SP →</p> | <p>Main setting</p> <p>SP →</p> |
| SP high/low limit | 12 | <p>Main setting Sub-setting</p> <p>SP →</p> | <p>Main setting Sub-setting</p> <p>SP →</p> |
| MV high limit | 13 | <p>Main setting</p> <p>MV →</p> | <p>Main setting</p> <p>MV →</p> |
| MV low limit | 14 | <p>Main setting</p> <p>MV →</p> | <p>Main setting</p> <p>MV →</p> |
| MV high/low limit | 15 | <p>Main setting Sub-setting</p> <p>MV →</p> | <p>Main setting Sub-setting</p> <p>MV →</p> |
| Heater 1 burnout/ Over-current | 16 | <p>Main setting Sub-setting</p> <p>CT1 at output ON. →</p> <p>OFF before measuring the CT1 current value</p> | <p>Main setting Sub-setting</p> <p>CT1 at output ON. →</p> <p>OFF before measuring the CT1 current value</p> |
| Heater 1 short-circuit | 17 | <p>Main setting</p> <p>CT1 at output OFF. →</p> <p>OFF before measuring the CT1 current value</p> | <p>Main setting</p> <p>CT1 at output OFF. →</p> <p>OFF before measuring the CT1 current value</p> |
| Heater 2 burnout/ Over-current | 18 | <p>Main setting Sub-setting</p> <p>CT2 at output ON. →</p> <p>OFF before measuring the CT2 current value</p> | <p>Main setting Sub-setting</p> <p>CT2 at output ON. →</p> <p>OFF before measuring the CT2 current value</p> |
| Heater 2 short-circuit | 19 | <p>Main setting</p> <p>CT2 at output OFF. →</p> <p>OFF before measuring the CT2 current value</p> | <p>Main setting</p> <p>CT2 at output OFF. →</p> <p>OFF before measuring the CT2 current value</p> |

| Operation type | Set value of operation type | Direct action | Reverse action |
|------------------|-----------------------------|--|----------------|
| Loop diagnosis 1 | 20 | <p>The event is turned ON when any change in PV corresponding to increase/decrease in MV (Manipulated variable) is not observed. This event is used to detect any fault at the operation end.</p> <ul style="list-style-type: none"> ● Setting items <ul style="list-style-type: none"> • Main setting: MV (Manipulated variable) • Sub-setting: PV • ON delay time: Diagnosis time ● Operation specifications <p>The event is turned ON when the value does not reach the PV set in the sub-setting within the diagnosis time (ON delay time) (conditions 1) even though the MV exceeding the main setting is held (conditions 2).</p> ● CAUTION <p>When setting the ON delay, it is necessary to put in "High function configuration". The default setting of the ON delay before shipment is 0.0s.</p> | |
| | | <p>Heat control</p> <p>Cool control</p> <p>ON delay is started when conditions 1 and 2 are satisfied.</p> | |

*: When the event type is CT1/2 heater burnout/over-current or CT1/2 heater short-circuit, the status becomes that the event judgment cannot be made from the time of power ON until that CT input current value is measured for the first time. In this case, the internal event output is OFF for both of direct action and reverse action in the direct/reverse setting. To avoid that the output becomes OFF at power ON when used in reverse action, set as follows:

(Setting example)

For direct/reverse setting of CT1/2 heater burnout/over-current or CT1/2 short-circuit event, select the direct action, and set the reverse operation in DO assignment calculation of the event output terminal (event terminal or control output terminal).

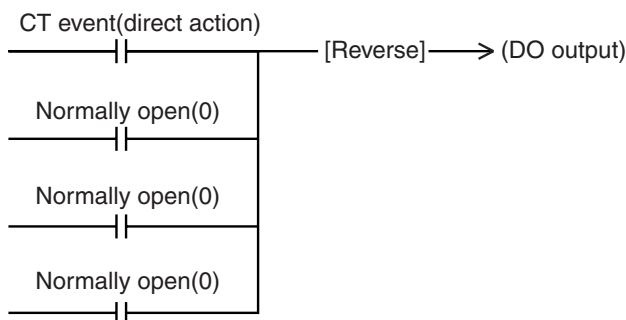

| Operation type | Set value of operation type | Direct action | Reverse action |
|------------------|-----------------------------|--|--|
| Loop diagnosis 2 | 21 | <p>The event is turned ON when any change in PV corresponding to increase/decrease in MV (Manipulated variable) is not observed.</p> <p>This event is used to detect any fault at the operation end.</p> <ul style="list-style-type: none"> ● Setting items <ul style="list-style-type: none"> • Main setting: MV (Manipulated variable) • Sub-setting: Change in PV from the point that the MV exceeds the main setting. • ON delay time: Diagnosis time ● Operation specifications <p>The event is turned ON when the MV exceeding the main setting is held (conditions 2) and the PV does not reach the value that the sub-setting is added to (subtracted from) the PV at the point that the MV exceeds the main setting within the diagnosis time (ON delay time) (conditions 1).</p> ● CAUTION <p>When setting the ON delay, it is necessary to put in "High function configuration".</p> <p>The default setting of the ON delay before shipment is 0.0s.</p> | |
| | | <p>Heat control</p> <p>ON delay is started when conditions 1 and 2 are satisfied.</p> | <p>Cool control</p> <p>ON delay is started when conditions 1 and 2 are satisfied.</p> |

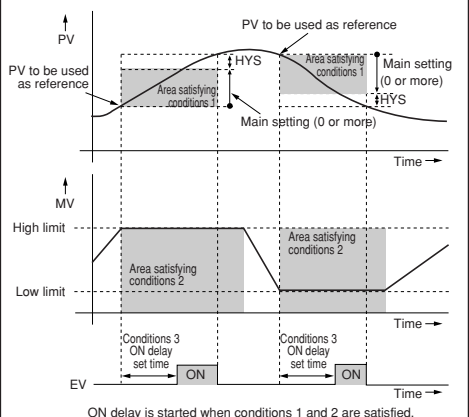
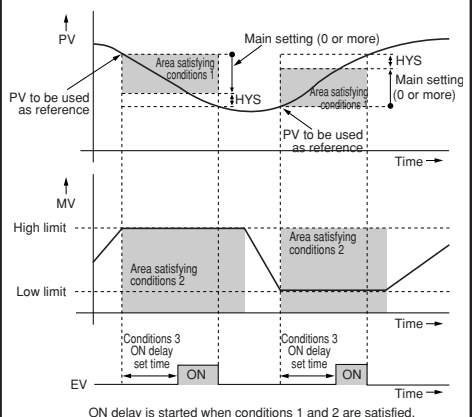
| Operation type | Set value of operation type | Direct action | Reverse action |
|------------------|-----------------------------|---|---|
| Loop diagnosis 3 | 22 | <p>The event is turned ON when any change in PV corresponding to increase/decrease in MV (Manipulated variable) is not observed. This event is used to detect any fault at the operation end.</p> <ul style="list-style-type: none"> ● Setting items <ul style="list-style-type: none"> • Main setting: Change in PV from the point that the MV reaches the high limit (100%) or low limit (0%). • Sub-setting: Range of absolute value of deviation (PV-SP) allowing the event to turn OFF. • ON delay time: Diagnosis time • OFF delay time: A period of time from power ON allowing the event to turn OFF. ● Operation specifications <ul style="list-style-type: none"> • The direct action is used for the heat control. The event is turned ON when the increase in PV becomes smaller than the main setting after the diagnosis time (ON delay time) has elapsed after the MV had reached the high limit or when the decrease in PV becomes smaller than the main setting after the diagnosis time (ON delay time) has elapsed after the MV had reached the low limit. • The reverse action is used for the cool control. The event is turned ON when the decrease in PV becomes smaller than the main setting after the diagnosis time (ON delay time) has elapsed after the MV had reached the high limit or when the increase in PV becomes smaller than the main setting after the diagnosis time (ON delay time) has elapsed after the MV had reached the low limit. • The event is turned OFF regardless of other conditions when the absolute value of the deviation (PV-SP) becomes less than the sub-setting. • The event is turned OFF regardless of other conditions when a period of time after starting of operation after the power has been turned ON becomes less than the OFF delay time. However, the event is turned OFF when the absolute value of the deviation is the (sub-setting - hysteresis) value or less after the absolute value of the deviation has become the sub-setting or more. ● CAUTION <p>When setting the ON delay and OFF delay, it is necessary to put in " High function configuration".</p> <p>The default settings of the ON delay and OFF delay before shipment are 0.0s.</p> | |
| | | <p>Heat control</p>  <p>ON delay is started when conditions 1 and 2 are satisfied.</p> | <p>Cool control</p>  <p>ON delay is started when conditions 1 and 2 are satisfied.</p> |

Chapter 5. SETTINGS BEFORE STARTING OPERATION

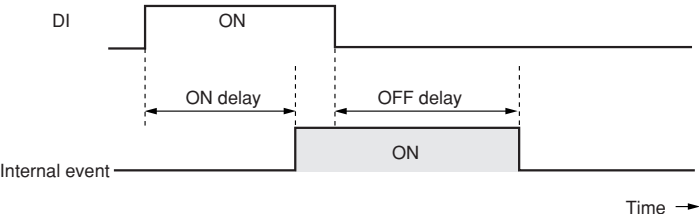
| Operation type | Set value of operation type | Direct action | Reverse action |
|----------------------------------|-----------------------------|---|--|
| Alarm (status) | 23 | ON if alarm occurs (alarm code AL01 to 99). OFF in other cases. | OFF if alarm occurs (alarm code AL01 to 99). ON in other cases. |
| READY (status) | 24 | ON in the READY mode. OFF in the RUN mode. | OFF in the READY mode. ON in the RUN mode. |
| MANUAL (status) | 25 | ON in the MANUAL mode. OFF in the AUTO mode. | OFF in the MANUAL mode. ON in the AUTO mode. |
| Invalid | 26 | Always OFF | Always ON |
| During AT (Status) | 27 | ON when AT is executed. OFF when AT is stopped. | OFF when AT is executed. ON when AT is stopped. |
| During SP ramp | 28 | ON during SP ramp. OFF when SP ramp is not performed or is completed. | OFF during SP ramp. ON when SP ramp is not performed or is completed. |
| Control action (status) | 29 | ON during direct action (cooling). OFF during reverse action (heating). | OFF during direct action (cooling). ON during reverse action (heating). |
| ST setting standby (status) | 30 | ON in the ST setting standby. OFF in the ST setting completion. | OFF in the ST setting standby. ON in the ST setting completion. |
| Invalid | 31 | Always OFF | Always ON |
| Timer (status) | 32 | <p>The direct and reverse action settings are disabled for the timer event. When using the timer event, it is necessary to set the operation type of the DI allocation to "Timer Start/Stop". Additionally, when setting the event channel designation of the DI allocation, multiple timer events are controlled from individual internal contacts (DI).</p> <ul style="list-style-type: none"> ● Setting items <ul style="list-style-type: none"> • ON delay time: A period of time necessary to change the event from OFF to ON after DI has been changed from OFF to ON. • OFF delay time: A period of time necessary to change the event from ON to OFF after DI has been changed from ON to OFF. ● Operation specifications <ul style="list-style-type: none"> • The event is turned ON when DI ON continues for ON delay time or longer. • The event is turned OFF when DI OFF continues for OFF delay time. • In other cases, the current status is continued.  <p style="text-align: right;">Time →</p> <ul style="list-style-type: none"> ● CAUTION <p>When setting the ON delay and OFF delay, it is necessary to put in "High function configuration". The default settings of the ON delay and OFF delay before shipment are 0.0s. The default setting of the event channel designation of the DI allocation before shipment is "0". In this case, the timer event start/stop can be set for all internal events from one internal contact (DI). Additionally, as one or more event channel designation is set, the timer event start/stop can be set for one internal event specified by one internal contact (DI). However, when setting the event channel of the DI allocation, it is necessary to put in "High function configuration".</p> | |
| High and low limits of MFB value | 33 | Invalid in this unit. ON/OFF status is undetermined. | Invalid in this unit. ON/OFF status is undetermined. |

■ Event operation type setup

(1) In the operation display mode, keep the [para] key pressed for 2 sec. or longer.

>> The unit then enters the parameter setting mode.

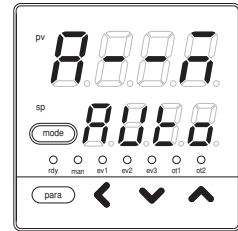

(2) In the parameter setting display mode, keep the [para] key pressed for 2 sec. or longer.

>> The display is then changed to the setup setting display.

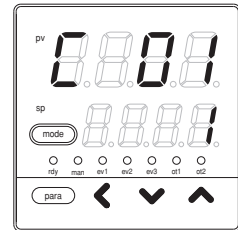

(3) Press the [para] key several times.

>> Display the setup setting [E1.C1: Internal Event 1 operation type].

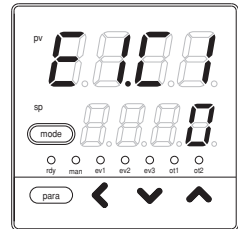

(4) Press the [<], [v], or [^] key to change the set value in [E1.C1].

Setting range: 0 to 33

>> When no keys are pressed for 2 sec. or longer, the flashing of the numeric value is stopped to set the currently displayed value.

(5) Press the [mode] key.

>> The display is returned to the operation display.

! Handling Precautions

- The displays of internal event 2 to 5 operation types are [E2.C1], [E3.C1], [E4. C1], and [E5.C1].
- Five internal events 1 to 5 are provided. However, the number of event outputs determined by the optional function is 0 to 3 points. In "Simple configuration", the operation of internal events 1 to 3 are output to event outputs 1 to 3. To use the operation of the internal events 4 to 5, the setup mode is changed to "High function configuration", and then [DO assignment] must be set.

■ Event Direct/Reverse, standby, and Event state at READY setup

(1) In the operation display mode, keep the [para] key pressed for 2 sec. or longer.

>> The unit then enters the parameter setting mode.

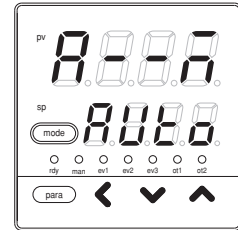

(2) In the parameter setting display mode, keep the [para] key pressed for 2 sec. or longer.

>> The display is then changed to the setup setting display.

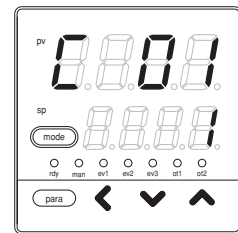

(3) Press the [para] key several times.

>> Display the setup setting [E1.C2:Internal Event 1 Direct/Reverse].

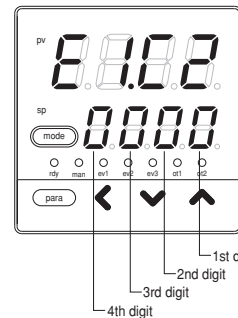

(4) Press the [<], [v], or [^] key to set the value you have selected from the following in [E1.C1].

| | |
|-----------|--------------------------------|
| 1st digit | Reverse |
| 0: | Not reversed. |
| 1: | Reversed. |
| 2nd digit | Standby |
| 0: | Standby not provided |
| 1: | Standby provided |
| 2: | Standby + Standby at SP change |
| 3rd digit | Event state at READY |
| 0: | Continue |
| 1: | Forced OFF |
| 4th digit | Undefined |

>> When no keys are pressed for 2 sec. or longer, the flashing of the numeric value is stopped to set the currently displayed value.

(5) Press the [mode] key.

>> The display is returned to the operation display.

! Handling Precautions

- The standby is a function that disables to turn ON the event even though the event in operation satisfies the ON conditions (before reverse) when the instrument power is turned ON or when the mode is changed from READY to RUN. The event is turned ON when the OFF conditions are satisfied once, and then the ON conditions are satisfied again.
- The standby + standby at SP change means that the standby is set again if the SP (SP value or SP group No.) is changed in addition to the normal standby.
- The internal event 2 to 5 direct/reverse, standby, and Event state at READY displays are [E2.C2], [E3.C2], [E4.C2], and [E5.C2].
- When the internal event operation type is [0: No event], the internal event direct/reverse is not displayed.

■ Event main setting setup

- (1) In the operation display mode, keep the [para] key pressed for 2 sec. or longer.
 >> The unit then enters the parameter setting mode.

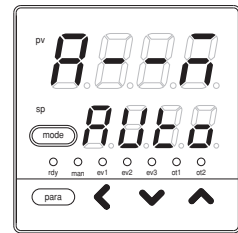

- (2) Press the [para] key several times.
 >> Display the parameter setting [E1: Internal event 1 main setting].

- (3) Press the [←], [∇], or [∧] key to change the set value in [E1].

Setting range: -1999 to +9999

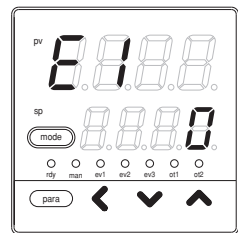

The decimal point position is changed corresponding to the event operation type.

For a part of the event operation types, the setting range becomes 0 to + 9999.

>> When no keys are pressed for 2 sec. or longer, the flashing of the numeric value is stopped to set the currently displayed value.

- (4) Press the [mode] key.
 >> The display is returned to the operation display.

ⓘ Handling Precautions

- The displays of the internal event 2 to 5 main settings are [E2], [E3], [E4], and [E5].
- When the internal event operation type is set at [0: No event] or the operation type does not need any main setting, the internal event main setting is not displayed.

■ Event sub-setting setup

- (1) In the operation display mode, keep the [para] key pressed for 2 sec. or longer.

>> The unit then enters the parameter setting mode.

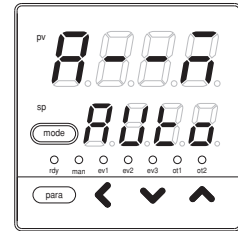

- (2) Press the [para] key several times.

>> Display the parameter setting [E1.Sb: Internal Event 1 sub-setting].

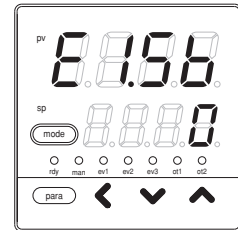

- (3) Press the [<], [v], or [^] key to change the set value in [E1.Sb].

Setting range: -1999 to +9999

The decimal point position is changed corresponding to the event operation type.

For a part of the event operation types, the setting range becomes 0 to + 9999.

>> When no keys are pressed for 2 sec. or longer, the flashing of the numeric value is stopped to set the currently displayed value.

- (4) Press the [mode] key.

>> The display is returned to the operation display.

! Handling Precautions

- The displays of the internal event 2 to 5 sub-settings are [E2.Sb], [E3.Sb], [E4.Sb], and [E5.Sb].
- When the internal event operation type is [0: No event] or the operation type does not need sub-setting, the internal event sub-setting is not displayed.

■ Event hysteresis setup

(1) In the operation display mode, keep the [para] key pressed for 2 sec. or longer.

>> The unit then enters the parameter setting mode.

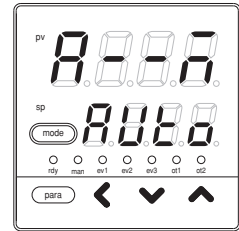

(2) Press the [para] key several times.

>> Display the parameter setting [E1.Hy: Internal Event 1 hysteresis].

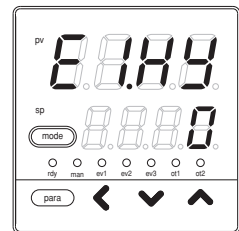

(3) Press the [<], [v], or [^] key to change the set value in [E1.Hy].

Setting range: 0 to 9999

The decimal point position is changed corresponding to the event operation type.

>> When no keys are pressed for 2 sec. or longer, the flashing of the numeric value is stopped to set the currently displayed value.

(4) Press the [mode] key.

>> The display is returned to the operation display.

ⓘ Handling Precautions

- The displays of the internal event 2 to 5 hysteresis are [E2.Hy], [E3.Hy], [E4.Hy], and [E5.Hy].
- When the internal event operation type is [0: No event] or the operation type does not need hysteresis, the internal event hysteresis is not displayed.

5 - 4 CT (Current Transformer) Input

The following settings are necessary when using the CT (Current Transformer) input of the optional model.

For CT input, two kinds of current values are provided.

- Current value at output ON: This value is used for the heater burnout/over-current event. The value is displayed as CT current value.
- Current value at output OFF: This value is used for the heater short-circuit event. The value cannot be displayed.

When [CT type] is set at “heater burnout detection”, the current value at output ON becomes the CT current value measured when the output specified in [CT output] is turned ON. The current value at output OFF becomes the CT current value measured when the output specified in [CT output] is turned OFF.

When [CT type] is set at “current value measurement”, the current value at output ON becomes the measured CT current value regardless of output ON/OFF status. The current value at output OFF is fixed at “0.0A”.

■ CT type setup

- (1) In the operation display mode, keep the [para] key pressed for 2 sec. or longer.
>> The unit then enters the parameter setting mode.

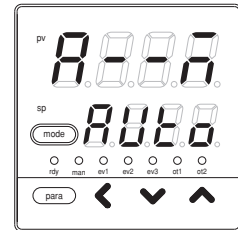

- (2) In the parameter setting display mode, keep the [para] key pressed for 2 sec. or longer.
>> The display is then changed to the setup setting display.

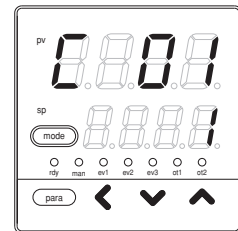

- (3) Press the [para] key several times.
>> Display the setup setting [C36:CT1 type].

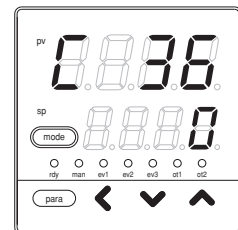

- (4) Press the [<], [v], or [^] key to set the value you have selected from the following in [C36].

- 0: Heater burnout detection
- 1: Current value measurement

>> When no keys are pressed for 2 sec. or longer, the flashing of the numeric value is stopped to set the currently displayed value.

- (5) Press the [mode] key.
>> The display is returned to the operation display.

! Handling Precautions

- The display of the CT2 type is [C39].
- When the additional function of the model is that CT is not provided, [C36] and [C39] are not displayed.

■ CT output setup

- (1) In the operation display mode, keep the [para] key pressed for 2 sec. or longer.

>> The unit then enters the parameter setting mode.

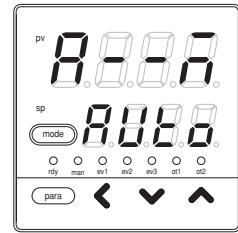

- (2) In the parameter setting display mode, keep the [para] key pressed for 2 sec. or longer.

>> The display is then changed to the setup setting display.

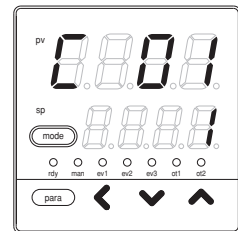

- (3) Press the [para] key several times.

>> Display the setup setting [C37: CT1 output].

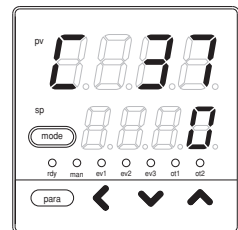

- (4) Press the [<], [v], or [^] key to set the value you have selected from the following in [C37].

- 0: Control output 1
- 1: Control output 2
- 2: Event output 1
- 3: Event output 2
- 4: Event output 3

Set an output used for ON/OFF control of the heater power, on which CT (current transformer) is installed.

>> When no keys are pressed for 2 sec. or longer, the flashing of the numeric value is stopped to set the currently displayed value.

- (5) Press the [mode] key.

>> The display is returned to the operation display.

! Handling Precautions

- The display of the CT2 output is [C40].
- When the optional function of the model is that CT is not provided, [C37] and [C40] are not displayed.
When [C36] is set at [1: Current measurement], [C37] is not displayed.
When [C39] is set at [1: Current measurement], [C40] is not displayed.

■ CT wait time before measurement setup

(1) In the operation display mode, keep the [para] key pressed for 2 sec. or longer.

>> The unit then enters the parameter setting mode.

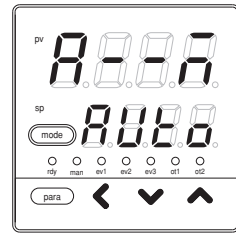

(2) In the parameter setting display mode, keep the [para] key pressed for 2 sec. or longer.

>> The display is then changed to the setup setting display.

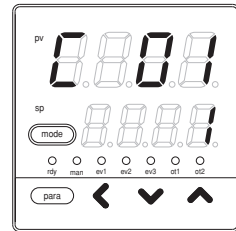

(3) Press the [para] key several times.

>> Display the setup setting [C38: CT1 wait time before measurement].

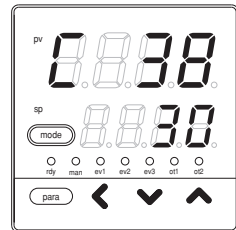

(4) Press the [<], [v], or [^] key to change the set value in [C38].

Setting range: 30 to 300ms

>> When no keys are pressed for 2 sec. or longer, the flashing of the numeric value is stopped to set the currently displayed value.

(5) Press the [mode] key.

>> The display is returned to the operation display.

❗ Handling Precautions

- The display of [CT2 wait time before measurement] is [C41].
- When the optional function of the model is that CT is not provided, [C38] and [C41] are not displayed.
When [C36] is set at [1: Current measurement], [C38] is not displayed.
When [C39] is set at [1: Current measurement], [C41] is not displayed.

5 - 5 Continuous Output

The settings below are necessary when the control output of the model uses the current output.

In a current range of 4 to 20mA or 0 to 20mA selected in [Output range], the current, that the value set in [Output type] is scaling-processed with [Output scaling low limit-high limit], is then output.

■ Output range setup

- (1) In the operation display mode, keep the [para] key pressed for 2 sec. or longer.
 >> The unit then enters the parameter setting mode.

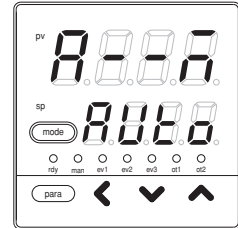

- (2) In the parameter setting display mode, keep the [para] key pressed for 2 sec. or longer.
 >> The display is then changed to the setup setting display.

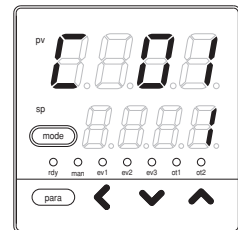

- (3) Press the [para] key several times.
 >> Display the setup setting [C42: Output 1 range].

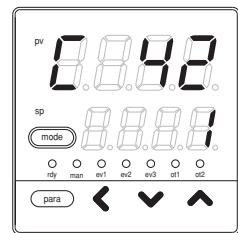

- (4) Press the [<], [v], or [^] key to set the value you have selected from the following in [C42].

- 1: 4 to 20mA
- 2: 0 to 20mA

>> When no keys are pressed for 2 sec. or longer, the flashing of the numeric value is stopped to set the currently displayed value.

- (5) Press the [mode] key.
 >> The display is returned to the operation display.

ⓘ Handling Precautions

- The display of the output 2 range is [C47].
- When the control output 1 of the model is set at “current”, [C42] is displayed.
 When the control output 2 of the model is set at “current”, [C47] is displayed.

■ Output type setup

- (1) In the operation display mode, keep the [para] key pressed for 2 sec. or longer.

>> The unit then enters the parameter setting mode.

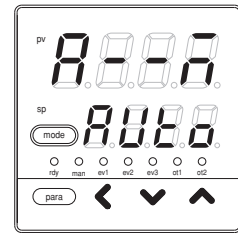

- (2) In the parameter setting display mode, keep the [para] key pressed for 2 sec. or longer.

>> The display is then changed to the setup setting display.

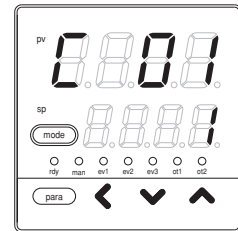

- (3) Press the [para] key several times.

>> Display the setup setting [C43: Output1 type].

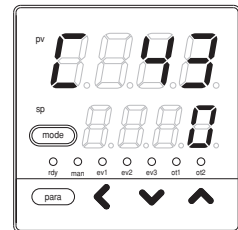

- (4) Press the [<], [v], or [^] key to set the value you have selected from the following in [C43].

| | | |
|------------------------------------|---|--|
| 0: MV (manipulated variable) | } | Scaled in units of 0.1%. |
| 1: Heat MV (for heat/cool control) | | |
| 2: Cool MV (for heat/cool control) | | |
| 3: PV | } | Scaled in the same unit of measure (°C, etc.) as the PV. |
| 4: PV before bias | | |
| 5: SP | | |
| 6: Deviation | } | Scaled in units of 0.1A. |
| 7: CT1 current value | | |
| 8: CT2 current value | | |
| 9: MFB (invalid on SDC15) | } | Scaled in the same unit of measure (°C, etc.) as the PV. |
| 10: SP+MV | | |
| 11: PV+MV | | |

>> When no keys are pressed for 2 sec. or longer, the flashing of the numeric value is stopped to set the currently displayed value.

- (5) Press the [mode] key.

>> The display is returned to the operation display.

! Handling Precautions

- The display of the output 2 type is [C48].
- When the control output 1 of the model is set at “current”, [C43] is displayed.
When the control output 2 of the model is set at “current”, [C48] is displayed.
- If ROM version 1 of the instrument information bank (*1002*) is prior to 2.04, the value is -180°C.

■ Output scaling low limit/high limit setup

(1) In the operation display mode, keep the [para] key pressed for 2 sec. or longer.

>> The unit then enters the parameter setting mode.

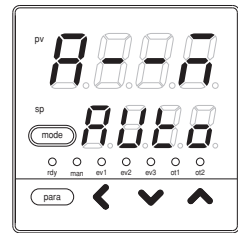

(2) In the parameter setting display mode, keep the [para] key pressed for 2 sec. or longer.

>> The display is then changed to the setup setting display.

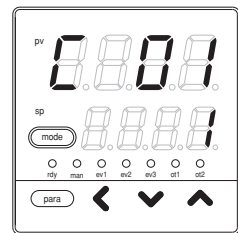

(3) Press the [para] key several times.

>> Display the setup setting [C44: Output 1 scaling low limit] or [C45: Output 1 scaling high limit].

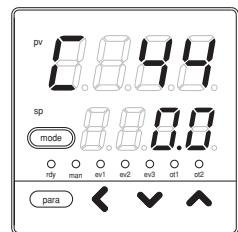

(4) Press the [<], [v], or [^] key to change the set value in [C44] and [C45].

Setting range: -1999 to +9999

The decimal point position and unit are changed corresponding to the output type.

>> When no keys are pressed for 2 sec. or longer, the flashing of the numeric value is stopped to set the currently displayed value.

(5) Press the [mode] key.

>> The display is returned to the operation display.

The following figures show the relationship between the output and the numeric value of the output type by output scaling low limit/high limit setup:

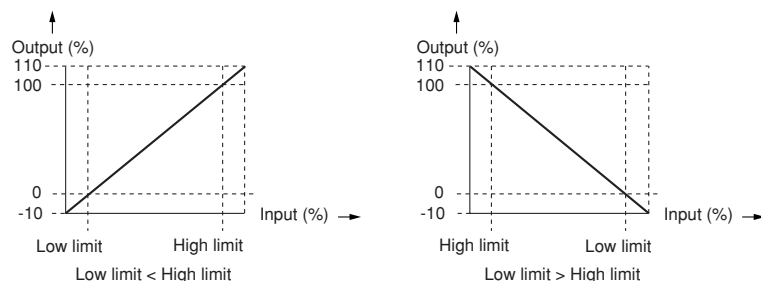

⚠ Handling Precautions

- The displays of the output 2 scaling low limit and high limit are [C49] and [C50].
- When the control output 1 of the model is set at “current”, [C44] and [C45] are displayed.
When the control output 2 of the model is set at “current”, [C40] and [C50] are displayed.

■ MV scaling range

When the control output type is set to either SP+MV or PV+MV, the control output is a continuous output in which the amount of change in the MV is added to the SP or PV.

- When the output type of control output 1, control output 2 or the auxiliary output is SP+MV or PV+MV, this item is displayed and can be set.

- The value calculated by the following formula is output according to the output scaling low/high limit settings:

In case of SP+MV, $(MV-50.0)/100.0 \times \text{MV scaling range} + \text{SP}$

In case of PV+MV, $(MV-50.0)/100.0 \times \text{MV scaling range} + \text{PV}$

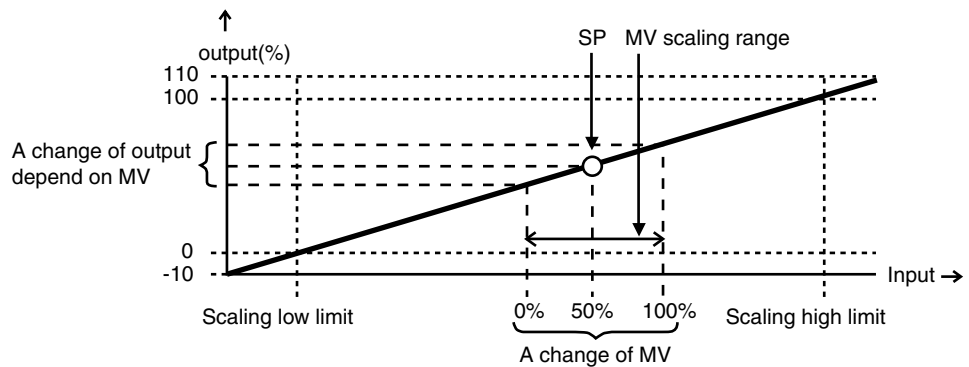

An example of the output type is SP+MV

⚠ Handling Precautions

- This function is used for cascade control when the continuous output of this controller is connected to the RSP (remote SP) of another controller, with this controller as master and the other controller as slave. Set the RSP range to MV scaling range, which changes in proportion to a change in the MV (0–100%) of this controller.
- If ROM version 1 of the instrument information bank (~~1.02~~) is prior to version 2.04, neither SP+MV nor PV+MV can be selected as an output type. The MV scaling range is not displayed and cannot be set.

5 - 6 Communication

The settings below are necessary when using the RS-485 communication, an optional function of the model.

In "Simple configuration", the communication mode, station address, transmission speed, data format (data length), data format (parity), and data format (stop bit) are set.

■ Communication mode setup

- (1) In the operation display mode, keep the [para] key pressed for 2 sec. or longer.
>> The unit then enters the parameter setting mode.

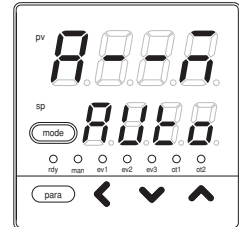

- (2) In the parameter setting display mode, keep the [para] key pressed for 2 sec. or longer.
>> The display is then changed to the setup setting display.

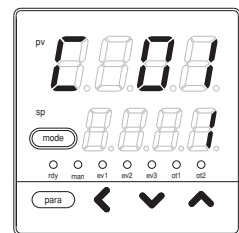

- (3) Press the [para] key several times.
>> Display the setup setting [C64: Communication mode].

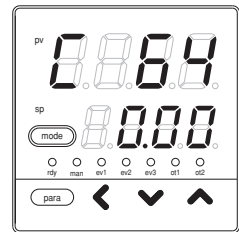

- (4) Press the [<], [v], or [^] key to set the value you have selected from the following in [C64].

- 0: CPL
- 1: MODBUS (ASCII format)
- 2: MODBUS (RTU format)

>> When no keys are pressed for 2 sec. or longer, the flashing of the numeric value is stopped to set the currently displayed value.

- (5) Press the [mode] key.
>> The display is returned to the operation display.

ⓘ Handling Precautions

When the RS-485 communication is provided as an optional function of the model, [C64] is displayed. Make the settings so that the communication mode becomes the same as that of the master station.

■ Station address setup

- (1) In the operation display mode, keep the [para] key pressed for 2 sec. or longer.

>> The unit then enters the parameter setting mode.

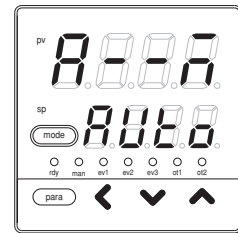

- (2) In the parameter setting display mode, keep the [para] key pressed for 2 sec. or longer.

>> The display is then changed to the setup setting display.

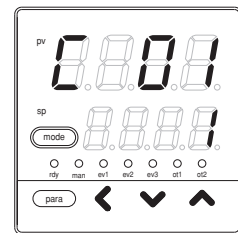

- (3) Press the [para] key several times.

>> Display the setup setting [C65: Station address].

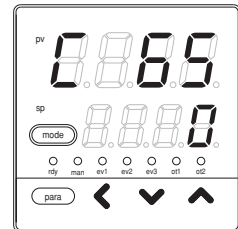

- (4) Press the [<], [v], or [^] key to change the set value in [C65].

Setting range: 0 to 127

>> When no keys are pressed for 2 sec. or longer, the flashing of the numeric value is stopped to set the currently displayed value.

- (5) Press the [mode] key.

>> The display is returned to the operation display.

! Handling Precautions

- Set [Station address] of an instrument multidrop-connected through the RS-485 to a value other than "0", which is not duplicated. If [Station address] is set at "0", the communication cannot be performed.
- When the optional function of the model includes RS-485, [C65] is displayed.

■ Transmission speed setup

- (1) In the operation display mode, keep the [para] key pressed for 2 sec. or longer.

>> The unit then enters the parameter setting mode.

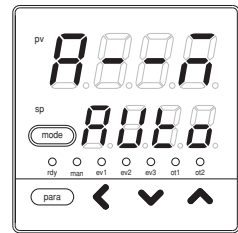

- (2) In the parameter setting display mode, keep the [para] key pressed for 2 sec. or longer.

>> The display is then changed to the setup setting display.

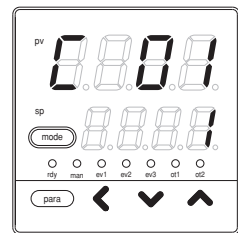

- (3) Press the [para] key several times.

>> Display the setup setting [C66: Transmission speed].

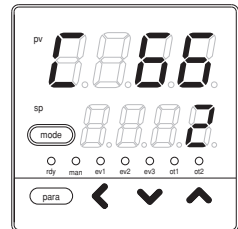

- (4) Press the [<], [v], or [^] key to set the value you have selected from the following in [C66].

- 0: 4800bps
- 1: 9600bps
- 2: 19200bps
- 3: 38400bps

>> When no keys are pressed for 2 sec. or longer, the flashing of the numeric value is stopped to set the currently displayed value.

- (5) Press the [mode] key.

>> The display is returned to the operation display.

! Handling Precautions

When the RS-485 communication is provided as an optional function of the model, [C66] is displayed. Make the settings so that the transmission speed becomes the same as that of the master station.

■ Data format (data length) setup

(1) In the operation display mode, keep the [para] key pressed for 2 sec. or longer.

>> The unit then enters the parameter setting mode.

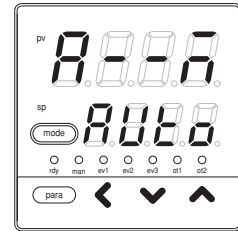

(2) In the parameter setting display mode, keep the [para] key pressed for 2 sec. or longer.

>> The display is then changed to the setup setting display.

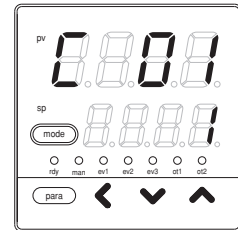

(3) Press the [para] key several times.

>> Display the setup setting [C67: Data format (data length)].

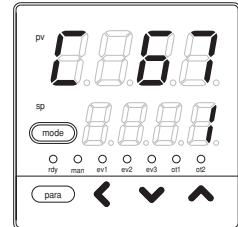

(4) Press the [<], [v], or [^] key to set the value you have selected from the following in [C67].

0: 7 bits

1: 8 bits

>> When no keys are pressed for 2 sec. or longer, the flashing of the numeric value is stopped to set the currently displayed value.

(5) Press the [mode] key.

>> The display is returned to the operation display.

ⓘ Handling Precautions

- When RS-485 is provided as an optional function of the model, [C67] is displayed. Make the settings so that the data format becomes the same as that of the master station of the communication.
- When the setup setting [C64: Communication mode] is set at [2: MODBUS (RTU format)], [C67] is not displayed. At this time, the data length becomes 8 bits.

■ Data format (parity) setup

- (1) In the operation display mode, keep the [para] key pressed for 2 sec. or longer.

>> The unit then enters the parameter setting mode.

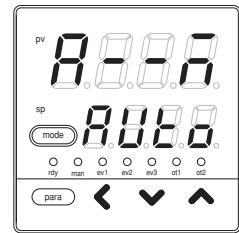

- (2) In the parameter setting display mode, keep the [para] key pressed for 2 sec. or longer.

>> The display is then changed to the setup setting display.

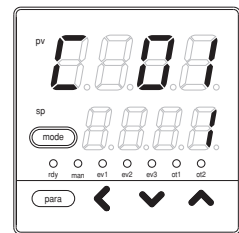

- (3) Press the [para] key several times.

>> Display the setup setting [C68: Data format (parity)].

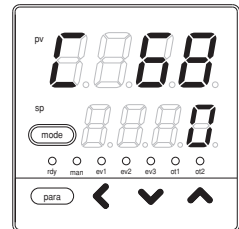

- (4) Press the [<], [v], or [^] key to set the value you have selected from the following in [C68].

- 0: Even parity
- 1: Odd parity
- 2: No parity

>> When no keys are pressed for 2 sec. or longer, the flashing of the numeric value is stopped to set the currently displayed value.

- (5) Press the [mode] key.

>> The display is returned to the operation display.

ⓘ Handling Precautions

- When RS-485 is provided as an optional function of the model, [C68] is displayed. Make the settings so that the data format becomes the same as that of the master station of the communication.

■ Data format (stop bit) setup

(1) In the operation display mode, keep the [para] key pressed for 2 sec. or longer.

>> The unit then enters the parameter setting mode.

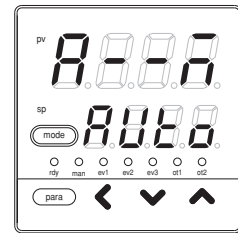

(2) In the parameter setting display mode, keep the [para] key pressed for 2 sec. or longer.

>> The display is then changed to the setup setting display.

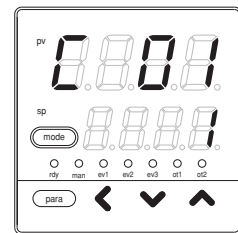

(3) Press the [para] key several times.

>> Display the setup setting [C69: Data format (stop bit)].

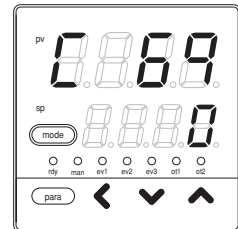

(4) Press the [<], [v], or [^] key to set the value you have selected from the following in [C69].

- 0: 1 stop bit
- 1: 2 stop bits

>> When no keys are pressed for 2 sec. or longer, the flashing of the numeric value is stopped to set the currently displayed value.

(5) Press the [mode] key.

>> The display is returned to the operation display.

ⓘ Handling Precautions

- When RS-485 is provided as an optional function of the model, [C69] is displayed. Make the settings so that the data format becomes the same as that of the master station of the communication.

5 - 7 Key Operation

In “Simple configuration”, the mode key function and user level are set.

■ Mode key function setup

- (1) In the operation display mode, keep the [para] key pressed for 2 sec. or longer.
>> The unit then enters the parameter setting mode.

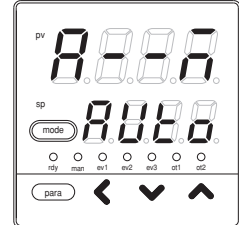

- (2) In the parameter setting display mode, keep the [para] key pressed for 2 sec. or longer.
>> The display is then changed to the setup setting display.

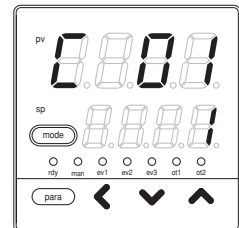

- (3) Press the [para] key several times.
>> Display the setup setting [C72: Mode key function].

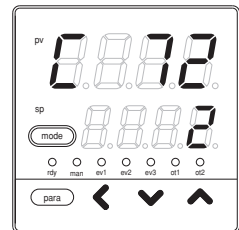

- (4) Press the [<], [v], or [^] key to set the value you have selected from the following in [C72].

- 0: Invalid
- 1: AUTO/MANUAL mode selection
- 2: RUN/READY mode selection
- 3: AT (Auto tuning) Stop/Start selection
- 4: LSP (Local SP) group selection
- 5: Release all DO (digital output) latches
- 6: Invalid
- 7: ON/OFF selection of communication DI (Digital Input) 1

>> When no keys are pressed for 2 sec. or longer, the flashing of the numeric value is stopped to set the currently displayed value.

- (5) Press the [mode] key.
>> The display is returned to the operation display.

❗ Handling Precautions

- When the parameter setting [Ctrl: Control method] is set at [0: ON/OFF control], the mode does not become the MANUAL mode. Therefore, even though the [MODE key function] is set at “AUTO/MANUAL mode selection”, this setting becomes invalid.
- When the setup setting [C30: LSP system group] is set at “1”, the LSP group cannot be changed. Therefore, even though [MODE key function] is set at “LSP group selection”, this setting becomes invalid at this time.

■ User level setup

- (1) In the operation display mode, keep the [para] key pressed for 2 sec. or longer.

>> The unit then enters the parameter setting mode.

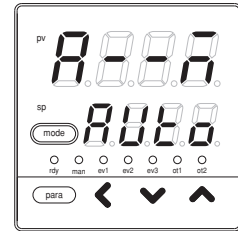

- (2) In the parameter setting display mode, keep the [para] key pressed for 2 sec. or longer.

>> The display is then changed to the setup setting display.

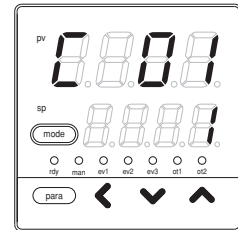

- (3) Press the [para] key several times.

>> Display the setup setting [C79: User level].

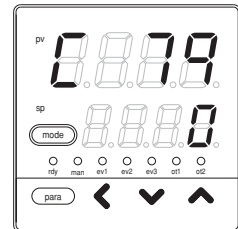

- (4) Press the [<], [v], or [^] key to set the value you have selected from the following in [C79].

- 0: Simple configuration
- 1: Standard configuration
- 2: High function configuration

>> When no keys are pressed for 2 sec. or longer, the flashing of the numeric value is stopped to set the currently displayed value.

- (5) Press the [mode] key.

>> The display is returned to the operation display.

ⓘ Handling Precautions

When [User level] is set at [Standard configuration] or [High function configuration], the description of this manual is insufficient. In this case, refer to Single Loop Controller SDC15 User's Manual "Installation & Configurations" (CP-SP-1148E).

5 - 8 DI Assignment

The settings below are necessary when using DI (digital input), an optional function of the model. In "Simple configuration", the internal contact operation type is set. With the default settings before shipment, the DI has been directly connected to the internal contact process. Therefore, the operation is performed only with the internal contact operation type.

Internal contact operation type setup

- (1) In the operation display mode, keep the [para] key pressed for 2 sec. or longer.
 >> The unit then enters the parameter setting mode.

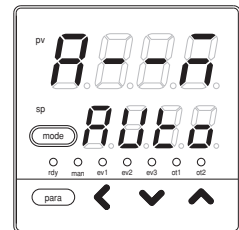

- (2) In the parameter setting display mode, keep the [para] key pressed for 2 sec. or longer.
 >> The display is then changed to the setup setting display.

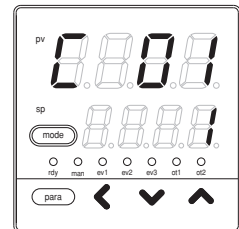

- (3) Press the [para] key several times.
 Display the setup setting [dI1.1: Internal contact 1 operation type].

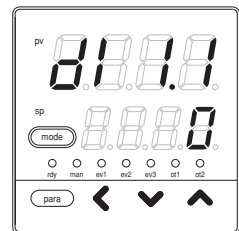

(4) Press the [<], [v], or [^] key to change the value set in [dI1.1] to that you have selected from the following table:

| Set value | Function | Operation at OFF | Operation at ON |
|-----------|---|---------------------------|---------------------------|
| 0 | No function | None | None |
| 1 | LSP group selection (0/+1) | LSP No.: +0 | LSP No.: +1 |
| 2 | LSP group selection (0/+2) | LSP No.: +0 | LSP No.: +2 |
| 3 | LSP group selection (0/+4) | LSP No.: +0 | LSP No.: +4 |
| 4 | PID group selection (0/+1) | Invalid | Invalid |
| 5 | PID group selection (0/+2) | Invalid | Invalid |
| 6 | PID group selection (0/+4) | Invalid | Invalid |
| 7 | RUN/READY mode selection | RUN | READY |
| 8 | AUTO/MANUAL mode selection | AUTO | MANUAL |
| 9 | LSP/RSP mode selection | Invalid | Invalid |
| 10 | AT (Auto tuning) Stop/Start | AT Stop | AT Start |
| 11 | ST (Self-tuning) disabled/enabled | ST disabled | ST enabled |
| 12 | Control action direct/reverse selection | Set action | Reverse action of setting |
| 13 | SP ramp enabled/disabled | SP ramp enabled | SP ramp disabled |
| 14 | PV value hold | No-hold | Hold |
| 15 | PV Max. hold | No-hold | Hold |
| 16 | PV Min. hold | No-hold | Hold |
| 17 | Timer Stop/Start | Timer stop | Timer start |
| 18 | Release all DO latches | Continue if latch exists. | Latch release |
| 19 | Advance operation | Invalid | Invalid |
| 20 | Step hold | Invalid | Invalid |

>> When no keys are pressed for 2 sec. or longer, the flashing of the numeric value is stopped to set the currently displayed value.

(5) Press the [mode] key.

>> The display is returned to the operation display.

[!] Handling Precautions

- The displays of the internal contact 2 to 3 operation types are [dI2.1] and [dI3.1].
- There are three internal contacts 1 to 3. However, the number of digital inputs determined by the optional function of the model is 0 to 2 points. With the default settings before shipment, the operation of digital inputs 1 to 2 has been connected to the internal contacts 1 to 2. When using the operation of internal contact 3, it is necessary to change the setup mode to “High function configuration” and set [DI assignment].
- For LSP group selection, a value that “1” is added to the sum of weights (+1, +2, and +4) when the internal contact is turned ON becomes the LSP group No.
- Do not use with [14: PV Hold], [15: PV Max. hold], and [16: PV Min. hold] mixed.
- For operation type other than [0: No function] and [1 to 3: LSP selection], the same operation type is set for multiple internal contacts.
- When using the heat/cool control, do not use [12: Control action direct/reverse selection].

Chapter 6. SETTINGS DURING OPERATION

6 - 1 SP

The SP can be set in either the operation display or parameter setting display mode.

■ SP setup in operation display mode

- (1) Make sure that the unit is in the operation display mode.
If the unit is in the parameter setting display or setup setting display mode, press the [mode] key.
>> The display is then returned to the operation display.

- (2) Make sure that the PV is shown on the display No. 1 and the SP is shown on the display No. 2.
If other data is shown, press the [para] key several times.
>> Display the PV on the display No. 1 and the SP on the display No. 2.

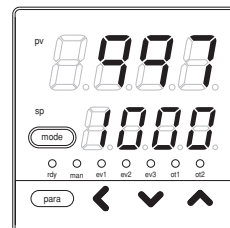

- (3) Press the [<], [v], or [^] key to change the set SP value.

Setting range: SP low limit to SP high limit

However, note that the PV input range low limit/high limit have already been set for the SP low limit/high limit.

>> When no keys are pressed for 2 sec. or longer, the flashing of the numeric value is stopped to set the currently displayed value.

! Handling Precautions

- With "Standard configuration" or "High function configuration", it is possible to make the settings so that the PV or SP is not displayed on the operation display.

At this time, either the PV or SP, or both the PV and SP are not displayed. Therefore, the actual display status may vary from the above description.

The SP cannot be set when the settings are made so that the SP is not shown in the operation display mode. At this time, however, the SP can be set in the parameter setting display mode.

- The SP low limit/high limit cannot be set with "Simple configuration".

■ LSP No. setup

(1) Make sure that the unit is in the operation display mode.

If the unit is in the parameter setting display or setup setting display mode, press the [mode] key.

>> The display is then returned to the operation display.

(2) Make sure that the LSP No. is shown on the display No. 1 and the SP corresponding to this LSP No. is shown on the display No. 2. If other data is shown, press the [para] key several times.

If other data is shown, press the [para] key several times.

If other data is shown, press the [para] key several times.

>> Display the LSP No. on the display No. 1 and the SP corresponding to this LSP No. on the display No. 2.

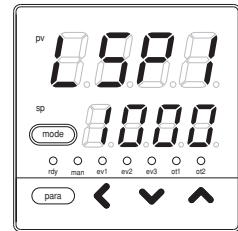

(3) Press the [<], [v], or [^] key to change the LSP No.

Setting range: 0 to LSP setting system group

>> When no keys are pressed for 2 sec. or longer, the flashing of the numeric value is stopped to set the currently displayed value.

! Handling Precautions

- When the setup setting [C30:LSP system group] is set at "1", [LSP No.] is not displayed.
- When the operation type of any of the internal contacts 1 to 3 is set at "LSP group selection", [LSP No.] cannot be changed.

■ SP setup in parameter setting display mode

- (1) In the operation display mode, keep the [para] key pressed for 2 sec. or longer.
 >> The unit then enters the parameter setting mode.

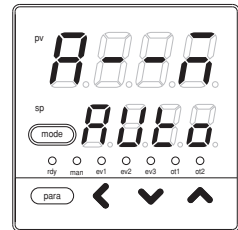

- (2) Press the [para] key several times.
 >> Display the setup setting [SP-1: SP of SP1 group].

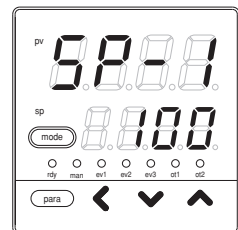

- (3) Press the [<], [v], or [^] key to change the set value in [SP-1].

Setting range: SP low limit to SP high limit

However, the PV input range low limit/high limit have already been set for the SP low limit/high limit.

>> When no keys are pressed for 2 sec. or longer, the flashing of the numeric value is stopped to set the currently displayed value.

- (4) Press the [mode] key.
 >> The display is returned to the operation display.

⚠ Handling Precautions

When the LSP groups are set up with the setup setting [C30: LSP system group], up to four groups, [SP-1], [SP-2], [SP-3], and [SP-4] can be used.

6 - 2 Operation Display other than SP

With "Simple configuration", the MV (manipulated variable) setting, heat MV (manipulated variable), cool MV (manipulated variable), AT progress, and CT (current transformer) inputs 1 and 2 are displayed.

■ MV (manipulated variable) display and setup

- (1) Make sure that the unit is in the operation display mode.

If the unit is in the parameter setting display or setup setting display mode, press the [mode] key.

>> The display is then returned to the operation display.

- (2) Press the [para] key several times.

>> Display [oUt] on the display No. 1 and the MV on the display No. 2. In the MANUAL mode, the 1st digit of the MV display starts flashing.

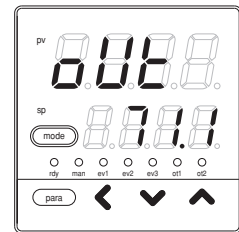

- (3) In the MANUAL mode, press the [<], [v], or [^] key to change the MV value.

Setting range: -10.0 to +110.0%

When using the time proportional output, a value ranging from - 10.0 to -0.1% is the same as 0.0%, that is, the output always becomes OFF.

Additionally, a value ranging from +100.1 to +110.0% is the same as 100.0%, that is, the output always becomes ON.

! Handling Precautions

- In the AUTO mode, the MV value is not changed even though the [<], [v], or [^] key is pressed.
- With "Standard configuration" or "High function configuration", it is possible to make the settings so that the MV is not displayed.

■ Heat MV (manipulated variable) and cool MV (manipulated variable) display

- (1) Make sure that the unit is in the operation display mode.
If the unit is in the parameter setting display or setup setting display mode, press the [mode] key.
>> The display is then returned to the operation display.

- (2) Press the [para] key several times.
>> Display [HEAt] on the display No. 1 and the heat MV on the display No. 2 or display [Cool] on the display No. 1 and the cool MV on the display No. 2.

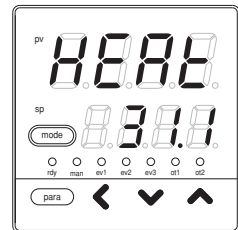

- (3) Even though the [<], [v], or [^] key is pressed, the heat MV and cool MV cannot be changed.

! Handling Precautions

With "Standard configuration" or "High function configuration", it is possible to make the settings so that the heat MV or cool MV is not displayed.

■ AT (auto tuning) progress display

- (1) Make sure that the unit is in the operation display mode.
If the unit is in the parameter setting display or setup setting display mode, press the [mode] key.
>> The display is then returned to the operation display.

- (2) Press the [para] key several times.
>> Display the PV value on the display No. 1, and [At] and progress No. on the display No. 2.
The progress No. becomes smaller as the AT is progressed.
When the AT is completed, the progress No. becomes "0".

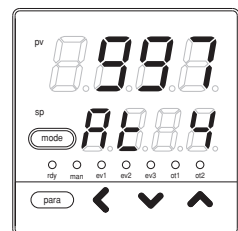

(When the progress No. is not "0", the No. may be skipped or returned depending on the AT calculation status.)

- (3) Even though the [<], [v], or [^] key is pressed, the AT progress cannot be changed.

! Handling Precautions

The display mode is changed to the AT progress display mode only when the AT is running in this unit.

■ CT (current transformer) input 1/2 current value display

(1) Make sure that the unit is in the operation display mode.

If the unit is in the parameter setting display or setup setting display mode, press the [mode] key.

>> The display is then returned to the operation display.

(2) Press the [para] key several times.

>> Display [Ct1] on the display No. 1 and the CT input 1 current value on the display No. 2, or display [Ct2] on the display No. 1 and the CT input 2 current value on the display No. 2.

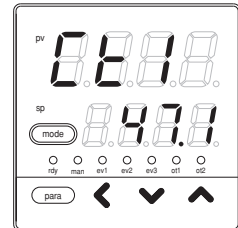

(3) Even though the [<], [v], or [^] key is pressed, the CT input1/2 values cannot be changed.

! Handling Precautions

- If the CT input current value cannot be updated when the CT type is set at "heater burnout detection" and the output specified for the CT output is OFF or ON for a short time, the flashing CT input current value is displayed.
- With "Standard configuration" or "High function configuration", it is possible to make the settings so that the CT input 1 or 2 is not displayed.

6 - 3 Mode

In "Simple configuration", AUTO/MANUAL mode selection, RUN/READY mode selection, AT (auto tuning) Stop/Start selection, release all DO (digital output) latches, and communication DI (digital input) 1 OFF/ON selection can be set.

However, the operation by the communication DI1 cannot be set only in "Simple configuration".

■ AUTO/MANUAL mode selection setup

- (1) In the operation display mode, keep the [para] key pressed for 2 sec. or longer.
 >> The parameter setting [A -- M: AUTO/MANUAL mode selection] is displayed.

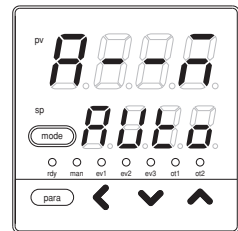

- (2) Press the [v], or [^] key to set the value you have selected from the following in [A -- M].

AUto: AUTO mode

MAN: MANUAL mode

- >> When no keys are pressed for 2 sec. or longer, the flashing of the numeric value is stopped to set the currently displayed value.

- (3) Press the [mode] key.

>> The display is returned to the operation display.

! Handling Precautions

- When [Ctrl: Control method] is set at [0: ON/OFF control], [A -- M] is not displayed.
- When the operation type of any of internal contacts 1 to 3 is set at "AUTO/MANUAL mode selection", [A -- M] cannot be changed.

■ RUN/READY mode selection setup

(1) In the operation display mode, keep the [para] key pressed for 2 sec. or longer.

>> The unit then enters the parameter setting mode.

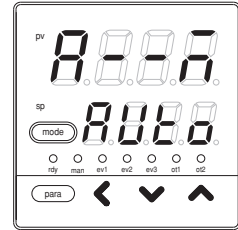

(2) In the parameter setting display mode, press the [para] key.

>> The parameter setting [r -- r:RUN/READY mode selection] is displayed.

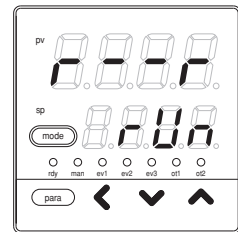

(3) Press the [v], or [^] key to set the value you have selected from the following in [r -- r].

rUn: RUN mode

rdy: READY mode

>> When no keys are pressed for 2 sec. or longer, the flashing of the numeric value is stopped to set the currently displayed value.

(4) Press the [mode] key.

>> The display is returned to the operation display.

! Handling Precautions

When the operation type of any of internal contacts 1 to 3 is set at "RUN/READY mode selection", [r -- r] cannot be changed.

■ AT (auto tuning) Stop/Start selection setup

(1) In the operation display mode, keep the [para] key pressed for 2 sec. or longer.

>> The unit then enters the parameter setting mode.

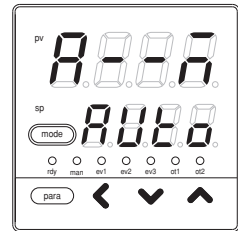

(2) Press the [para] key several times.

>> Display the parameter setting [At: AT Stop/Start selection].

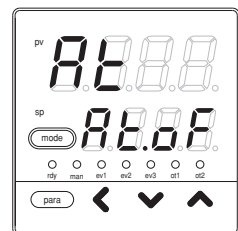

(3) Press the [v], or [^] key to set the value you have selected from the following in [At].

At.oF: AT stop

At.on: AT start

>> When no keys are pressed for 2 sec. or longer, the flashing of the numeric value is stopped to set the currently displayed value.

(4) Press the [mode] key.

>> The display is returned to the operation display.

! Handling Precautions

When the operation type of any of internal contacts 1 to 3 is set at “AT Stop/Start selection”, [At] cannot be changed.

When using the AT function,

☞ refer to 8-1 AT (auto tuning) function (on page 8-2).

■ Release all DO (digital output) latches setup

(1) In the operation display mode, keep the [para] key pressed for 2 sec. or longer.

>> The unit then enters the parameter setting mode.

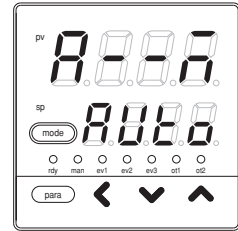

(2) Press the [para] key several times.

>> Display the parameter setting [do.Lt: Release all DO latches].

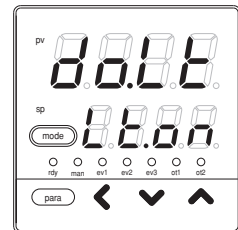

(3) Press the [v], or [^] key to set the value you have selected from the following in [do.Lt].

Lt.on: Latch continue

Lt.oF: Latch release

>> When no keys are pressed for 2 sec. or longer, the flashing of the numeric value is stopped to set the currently displayed value. When releasing the latch in the digital output process after setting [Lt.oF], the setting item is automatically changed to [Lt.on].

(4) Press the [mode] key.

>> The display is returned to the operation display.

■ Communication DI (digital input) 1 setup

(1) In the operation display mode, keep the [para] key pressed for 2 sec. or longer.

>> The unit then enters the parameter setting mode.

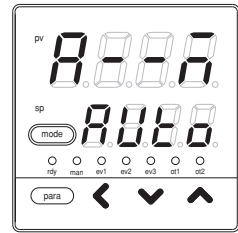

(2) Press the [para] key several times.

>> Display the parameter setting [C.dI1:
Communication DI 1] is displayed.

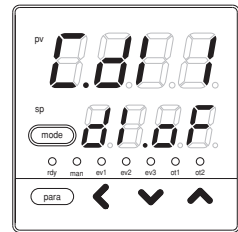

(3) Press the [v], or [^] key to set the value you have selected from the following in [C.dI1].

dl.oF: Communication dI1 OFF

dl.on: Communication dI1 ON

>> When no keys are pressed for 2 sec. or longer, the flashing of the numeric value is stopped to set the currently displayed value.

(4) Press the [mode] key.

>> The display is returned to the operation display.

6 - 4 PID

In this unit, the number of PID groups is one. When [Ctrl: Control method] is set at “0” (ON/OFF control), the PID cannot be set.

In "Simple configuration", P-1 (Proportional band), I-1 (Integral time), D-1 (Derivative time), rE-1 (Manual reset), P-1C (P (Proportional band) (cool)), I-1C (I (Integral time) (cool)), and d-1c (D (Derivative time) (cool)) can be set.

■ P-1 (proportional band) setup

- (1) In the operation display mode, keep the [para] key pressed for 2 sec. or longer.
 >> The unit then enters the parameter setting mode.

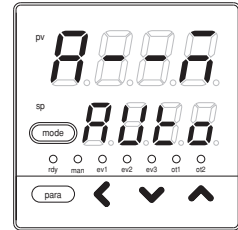

- (2) Press the [para] key several times.
 >> Display the parameter setting [P-1: Proportional band].

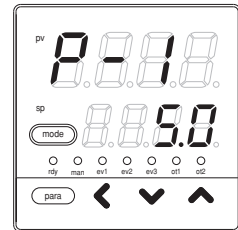

- (3) Press the [v], or [^] key to change the set value in [P-1].

Setting range: 0.1 to 999.9%

>> When no keys are pressed for 2 sec. or longer, the flashing of the numeric value is stopped to set the currently displayed value.

- (4) Press the [mode] key.
 >>The display is returned to the operation display.

⚠ Handling Precautions

When [Ctrl: Control method] is set at [0: ON/OFF control], [P-1] is not displayed.

■ I-1 (Integral time) setup

- (1) In the operation display mode, keep the [para] key pressed for 2 sec. or longer.

>> The unit then enters the parameter setting mode.

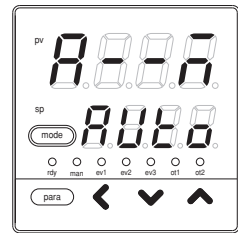

- (2) Press the [para] key several times.

>> Display the parameter setting [I-1: Integral time].

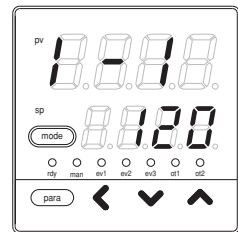

- (3) Press the [v], or [^] key to change the set value in [I-1].

Setting range: 0 to 9999s

>> When no keys are pressed for 2 sec. or longer, the flashing of the numeric value is stopped to set the currently displayed value.

- (4) Press the [mode] key.

The display is returned to the operation display.

! Handling Precautions

When [Ctrl: Control method] is set at [0: ON/OFF control], [I-1] is not displayed.

■ d-1 (Derivative time) setup

(1) In the operation display mode, keep the [para] key pressed for 2 sec. or longer.

>> The unit then enters the parameter setting mode.

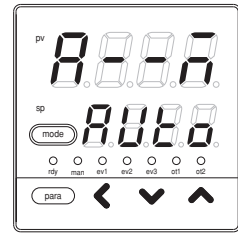

(2) Press the [para] key several times.

>> Display the parameter setting [d-1: Derivative time].

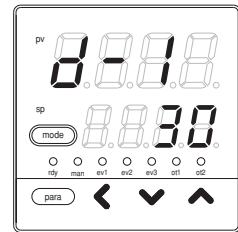

(3) Press the [v], or [^] key to change the set value in [d-1].

Setting range: 0 to 9999s

>> When no keys are pressed for 2 sec. or longer, the flashing of the numeric value is stopped to set the currently displayed value.

(4) Press the [mode] key.

>> The display is returned to the operation display.

! Handling Precautions

When [Ctrl: Control method] is set at [0: ON/OFF control], [d-1] is not displayed.

■ rE-1 (Manual reset) setup

(1) In the operation display mode, keep the [para] key pressed for 2 sec. or longer.

>> The unit then enters the parameter setting mode.

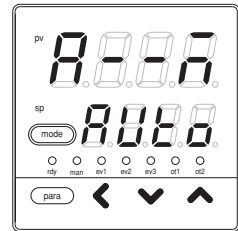

(2) Press the [para] key several times.

>> Display the parameter setting [rE-1: Manual reset].

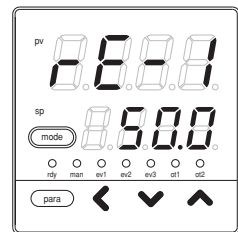

(3) Press the [v], or [^] key to change the set value in [rE-1].

Setting range: -10.0 to +110.0%

>> When no keys are pressed for 2 sec. or longer, the flashing of the numeric value is stopped to set the currently displayed value.

(4) Press the [mode] key.

>> The display is returned to the operation display.

! Handling Precautions

- When [Ctrl: Control method] is set at [0: ON/OFF control], [rE-1] is not displayed.
- When [C26: Heat/Cool control selection] is set at [0: disabled] and [I-1: Integral time] is set at a value other than "0", [rE-1] is not displayed.
- When [C26: Heat/Cool control selection] is set at [1: enabled] and both [I-1: Integral time] and [I-1c: I (integral time) (cool)] are set at a value other than "0", [rE-1] is not displayed.

■ P-1C (Proportional band - cool) setup

(1) In the operation display mode, keep the [para] key pressed for 2 sec. or longer.

>> The unit then enters the parameter setting mode.

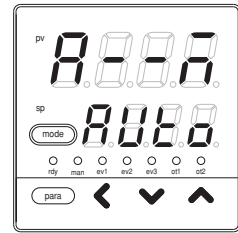

(2) Press the [para] key several times.

>> Display the parameter setting [P-1C: P (Proportional band) (cool)].

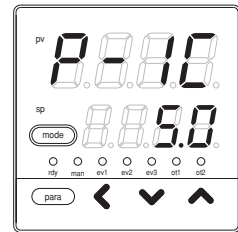

(3) Press the [v], or [^] key to change the set value in [P-1C].

Setting range: 0.1 to 999.9%

>> When no keys are pressed for 2 sec. or longer, the flashing of the numeric value is stopped to set the currently displayed value.

(4) Press the [mode] key.

>> The display is returned to the operation display.

! Handling Precautions

When [Ctrl: Control method] is set at [0: ON/OFF control] or [C26: Heat/Cool control selection] is set at [0: disabled], [P-1C] is not displayed.

■ I-1C (Integral time - cool) setup

(1) In the operation display mode, keep the [para] key pressed for 2 sec. or longer.

>> The unit then enters the parameter setting mode.

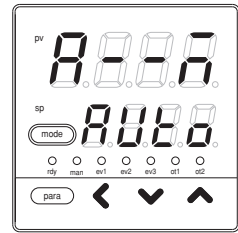

(2) Press the [para] key several times.

>> Display the parameter setting [I-1C: I (Integral time) (cool)].

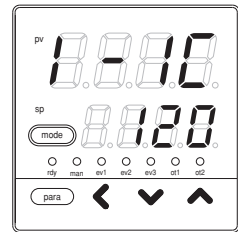

(3) Press the [v], or [^] key to change the set value in [I-1C].

Setting range: 0 to 9999s

>> When no keys are pressed for 2 sec. or longer, the flashing of the numeric value is stopped to set the currently displayed value.

(4) Press the [mode] key.

The display is returned to the operation display.

! Handling Precautions

When [Ctrl: Control method] is set at [0: ON/OFF control] or [C26: Heat/Cool control selection] is set at [0: disabled], [I-1C] is not displayed.

■ d-1C (Derivative time - cool) setup

(1) In the operation display mode, keep the [para] key pressed for 2 sec. or longer.

>> The unit then enters the parameter setting mode.

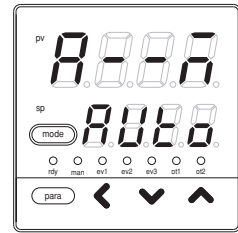

(2) Press the [para] key several times.

>> Display the parameter setting [d-1C: D (Derivative time) (cool)].

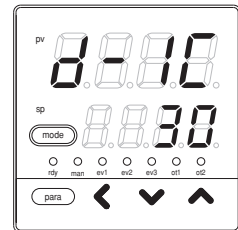

(3) Press the [v], or [^] key to change the set value in [d-1C].

Setting range: 0 to 9999s

>> When no keys are pressed for 2 sec. or longer, the flashing of the numeric value is stopped to set the currently displayed value.

(4) Press the [mode] key.

>> The display is returned to the operation display.

! Handling Precautions

When [Ctrl: Control method] is set at [0: ON/OFF control] or [C26: Heat/Cool control selection] is set at [0: disabled], [d-1C] is not displayed.

6 - 5 Other Parameter Setup

In "Simple configuration", the ON/OFF control differential, PV filter, PV bias, time proportional cycle time 1/2, MV low limit and high limit at AT (auto tuning), key lock, password display, and password 1A to 2B can be set.

■ ON/OFF control differential setup

- (1) In the operation display mode, keep the [para] key pressed for 2 sec. or longer.
>> The unit then enters the parameter setting mode.

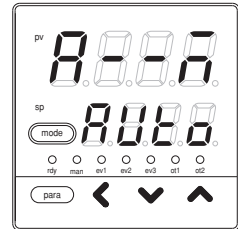

- (2) Press the [para] key several times.
>> Display the parameter setting [dIFF: ON/OFF control differential].

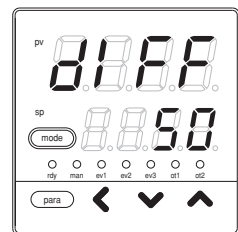

- (3) Press the [v], or [^] key to change the set value in [dIFF].

Setting range: 0 to 9999U

The decimal point is changed corresponding to the PV range.

>> When no keys are pressed for 2 sec. or longer, the flashing of the numeric value is stopped to set the currently displayed value.

- (4) Press the [mode] key.
>> The display is returned to the operation display.

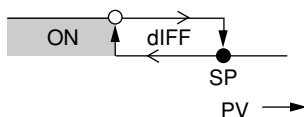

Heat control (Reverse action)

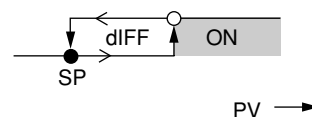

Cool control (Direct action)

- shows that the ON/OFF is changed at this value.
- shows that the ON/OFF is changed at a point that "1U" is added to this value.

⚠ Handling Precautions

When [Ctrl: Control method] is set at a value other than "0" (ON/OFF control), [dIFF] is not displayed.

■ PV filter setup

The PV filter (primary filter with the software) is activated to remove the noise from the PV input.

- (1) In the operation display mode, keep the [para] key pressed for 2 sec. or longer.
 >> The unit then enters the parameter setting mode.

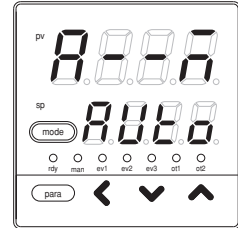

- (2) Press the [para] key several times.
 >> Display the parameter setting [FL: PV filter].

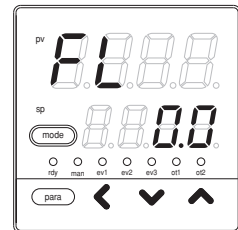

- (3) Press the [<], [v], or [^] key to change the set value in [FL].

Setting range: 0.0 to 120.0s

>> When no keys are pressed for 2 sec. or longer, the flashing of the numeric value is stopped to set the currently displayed value.

- (4) Press the [mode] key.
 >> The display is returned to the operation display.

■ PV bias setup

The PV bias is activated to correct the PV input error.

- (1) In the operation display mode, keep the [para] key pressed for 2 sec. or longer.
 >> The unit then enters the parameter setting mode.

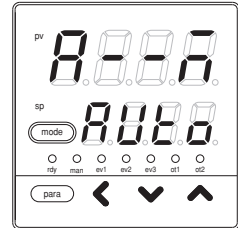

- (2) Press the [para] key several times.
 >> Display the parameter setting [bI: PV bias].

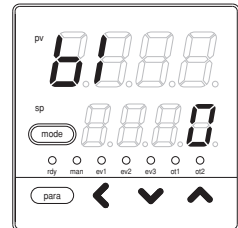

- (3) Press the [←], [∨], or [∧] key to change the set value in [bI].

Setting range: -1999 to + 9999U

The decimal point position is changed corresponding to the PV range.

>> When no keys are pressed for 2 sec. or longer, the flashing of the numeric value is stopped to set the currently displayed value.

- (4) Press the [mode] key.
 >> The display is returned to the operation display.

■ Time proportional cycle time 1/2 setup

(1) In the operation display mode, keep the [para] key pressed for 2 sec. or longer.

>> The unit then enters the parameter setting mode.

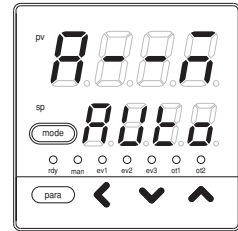

(2) Press the [para] key several times.

>> Display the parameter setting [Cy: Time proportional cycle time 1] or [Cy2: Time proportional cycle time 2].

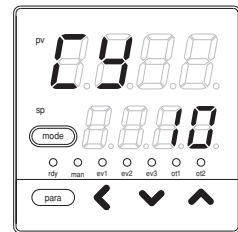

(3) Press the [<], [v], or [^] key to change the set value in [Cy].

Setting range: 5 to 120 sec. The output includes the relay output.

1 to 120 sec. The output does not include the relay output.

>> When no keys are pressed for 2 sec. or longer, the flashing of the numeric value is stopped to set the currently displayed value.

(4) Press the [mode] key.

>> The display is returned to the operation display.

ⓘ Handling Precautions

- When the heat/cool control is not used, the time proportional cycle time is set using [Cy], and [Cy2] is not displayed. When using the heat/cool control, the time proportional cycle time of MV (manipulated variable) on the heat side is set using [Cy] and the time proportional cycle time of MV (manipulated variable) on the cool side is set using [Cy2].
- When the time proportional cycle time setting of the relay output is less than 5 sec., the relay output is operated with time proportional cycle time of 5 sec.

■ MV low limit/high limit at AT (auto tuning)

- (1) In the operation display mode, keep the [para] key pressed for 2 sec. or longer.
 >> The unit then enters the parameter setting mode.

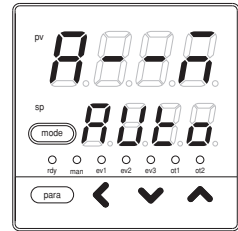

- (2) Press the [para] key several times.
 >> Display the parameter setting [At.oL: MV low limit at AT] or [At.oH: MV high limit at AT]. The Figure on the right shows that [At.oL: MV low limit at AT] is displayed.

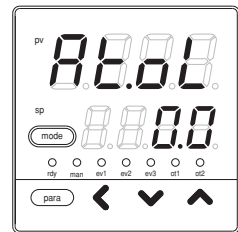

- (3) Press the [<], [v], or [^] key to change the set value in [At.oL] and [At.oH].

Setting range: -10.0 to +110.0%

- >> When no keys are pressed for 2 sec. or longer, the flashing of the numeric value is stopped to set the currently displayed value.

- (4) Press the [mode] key.
 >> The display is returned to the operation display.

! Handling Precautions

When [Ctrl: Control method] is set at [0: ON/OFF control], [At.oL] and [At.oH] are not displayed.

■ AT type setup

- (1) In the operation display mode, keep the [para] key pressed for 2 sec. or longer.

>> The unit then enters the parameter setting mode.

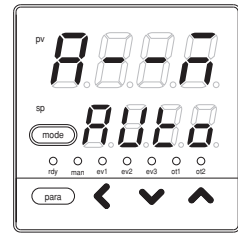

- (2) Press the [para] key several times.

>> Display the parameter setting [At.ty: AT type].

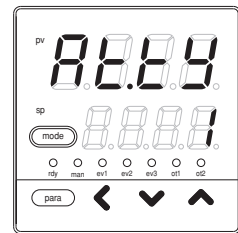

- (3) Press the [<], [v], or [^] key to set the value you have selected from the following in [At.ty].

0: Normal (Standard control characteristics)

1: Immediate response (Control characteristics immediately responding to external disturbance)

2: Stable (Control characteristics having less up/down fluctuation of PV)

>> When no keys are pressed for 2 sec. or longer, the flashing of the numeric value is stopped to set the currently displayed value.

- (4) Press the [mode] key.

>> The display is returned to the operation display.

! Handling Precautions

- The set value “1” (immediate response) is suitable for a process that the heater heat affects the PV directly and is intended for the adjustment aiming at the immediate response.
- The set value “2” (stable) is suitable for a process that the heater heat affects the PV indirectly and is intended for the adjustment aiming at the stability.
- When compared to the AT function of Azbil Corporation’s conventional model, the results similar to the SDC10 are obtained when the set value “1” (immediate response) is set and the results similar to the SDC20/21 are obtained when the set value “0” (normal) is used.

■ Key lock setup

- (1) In the operation display mode, keep the [para] key pressed for 2 sec. or longer.

>> The unit then enters the parameter setting mode.

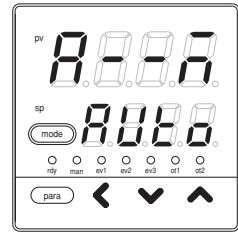

- (2) In the parameter setting display mode, keep the [para] key pressed for 2 sec. or longer.

>> The display is then changed to the setup setting display.

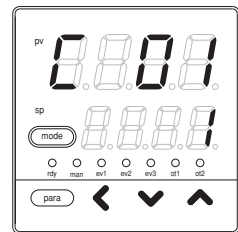

- (3) Press the [para] key several times.

>> Display the setup setting [Key lock].

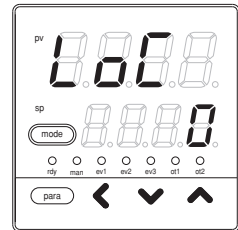

- (4) Press the [<], [v], or [^] key to select the set value in [LoC] from the following:

0: All settings are possible.

1: Mode, event, operation display, SP, UF, lock, manual MV, and mode key can be set.

2: Operation display, SP, UF, lock, manual MV, and mode key can be set.

3: UF, lock, manual MV, and mode key can be set.

>> When no keys are pressed for 2 sec. or longer, the flashing of the numeric value is stopped to set the currently displayed value.

- (5) Press the [mode] key.

>> The display is returned to the operation display.

! Handling Precautions

When two sets of passwords (1A and 1B, 2A and 2B) are met, the set value can be changed.

■ Password lock function

This controller has a password lock function using a password in addition to the key lock function. It offers a double security so that the key lock setting itself cannot be changed by unauthorized operators. In password lock function, the setting to disable the change in key lock function cannot be displayed.

The passwords are made by two groups of numerical values. Each value consists of 4 digits. The setting can be changed only when the two groups (1A and 1B, 2A and 2B) are matched. In order to prevent incorrect password setting, the password cannot be set if the setting value is set to 5 in the password display. In addition, the setting value of this password display is returned to zero (0) at every power supply ON.

● Password setup flow

Setting of password display

The status is changed to the one under which the password can be set.

Setting of passwords (1A, 2A)

When PS1A and PS2A are set, the PS1B is same as the PS1A, and the PS2A is same as the PS2B.

Setting of password (1B, 2B)

When the PS1B and the PS2B are set to the values different from the ones of PS1A and PS2A, the mode is changed to the password lock status and the setting cannot be made.

Cancellation of password lock

When the PS1B is set to the same value as the PS1A in the password setting and the PS2B is set to the same value as the PS2A, the password lock status is cancelled. In addition, when setting to the mode where the password setting cannot be made, set the setting value of PASS password display to the value other than 5.

■ Password display setup

- (1) In the operation display mode, keep the [para] key pressed for 2 sec. or longer.

>> The unit then enters the parameter setting mode.

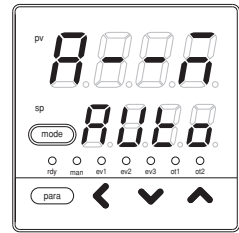

- (2) In the parameter setting display mode, keep the [para] key pressed for 2 sec. or longer.

>> The display is then changed to the setup setting display.

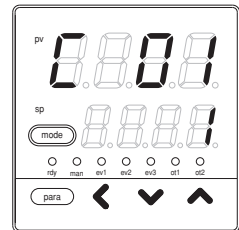

- (3) Press the [para] key several times.

>> Display the setup setting [PASS: Password display].

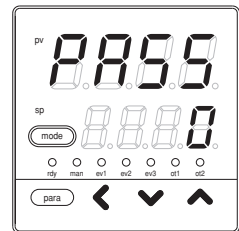

- (4) Press the [<], [v], or [^] key to change the set value in [PASS].

Setting range: 0 to 15

When “5” is set, the passwords 1A to 2B can be displayed. When the power is turned ON, the setting is returned to “0”.

>> When no keys are pressed for 2 sec. or longer, the flashing of the numeric value is stopped to set the currently displayed value.

- (5) Press the [mode] key.

>> The display is returned to the operation display.

! Handling Precautions

[PASS] limits to the conditions to display the passwords 1A, 2A, 1B and 2B, in order to prevent incorrect password setting.

■ Passwords (1A, 2A, 1B, 2B) setup

(1) In the operation display mode, keep the [para] key pressed for 2 sec. or longer.

>> The unit then enters the parameter setting mode.

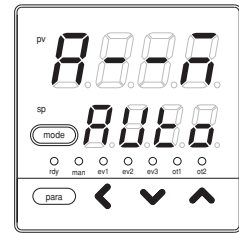

(2) In the parameter setting display mode, keep the [para] key pressed for 2 sec. or longer.

>> The display is then changed to the setup setting display.

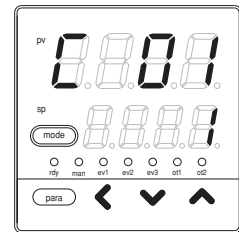

(3) Press the [para] key several times.

>> Display the setup setting [PS1A: Password 1A].

The same operation applies to the following passwords:

PS2A: Password 2A

PS1B: Password 1B

PS2B: Password 2B

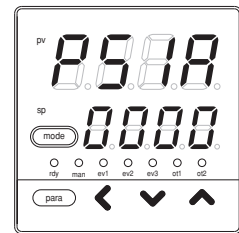

(4) Press the [<], [v], or [^] key to change the set value in [PS1A].

Setting range: 0000 to FFFF

The same operation applies to other passwords PS2A, PS1B, and PS2B.

>> When no keys are pressed for 2 sec. or longer, the flashing of the numeric value is stopped to set the currently displayed value.

As PS1A is set, the same value is set in PS1B. Accordingly, when PS2A is set, the same value is set in PS2B.

(5) Press the [mode] key.







>> The display is returned to the operation display.

! Handling Precautions

- Before setting the passwords 1A, 2A, 1B and 2B, determine two hexadecimal values to be used as passwords and take a memorandum of these passwords to record them.
- When other values are set for passwords 1B and 2B after the values to be used as passwords have been set for passwords 1A and 2A, the passwords 1A and 2A cannot be displayed and the key lock cannot be changed.
This status is called “password lock status”.
- The settings, which cannot be changed by the key lock, cannot be displayed in the password lock mode.

Chapter 7. LIST OF SIMPLE CONFIGURATION DISPLAY ITEMS

7 - 1 List of Operation Displays



| Display | Item | Contents | Initial value | Notes |
|--|---|---|---------------|--|
| Display No.1: PV Display No.2: SP | SP (Target value) | SP low limit (C07) to SP high limit (C08) | 0 | |
|  Display No.2: SP | LSP No. (1st digit: Value at the right end digit) | 1 to LSP system group (Max. 4) | 1 | Displayed when [LSP system group] (C30) is 2 or more. The display No. 2 shows the SP set value corresponding to the LSP No. |
|  | MV (Manipulated Variable) | -10.0 to 110.0% Setting is disabled in AUTO mode. (Numeric value does not flash.) Setting is enabled in MANUAL mode. (Numeric value flashes.) | — | In the ON/OFF control, "100.0" is displayed at ON and "0.0" is displayed at OFF. |
|  | Heat MV (Manipulated Variable) | Setting is disabled. | — | Displayed when using the heat cool control (C26=1). |
|  | Cool MV (Manipulated Variable) | Setting is disabled. | — | Displayed when using the heat/cool control (C26=1). |
| Display No. 1: PV  | AT progress display (1st digit = Numeric value at right end digit) | Setting is disabled. 1 - : During execution of AT (Value is decreased.) 0: Completion of AT | — | The display mode is changed to the AT progress display mode only when the AT is running in this unit. |
|  | CT (Current transformer) current value 1 | Setting is disabled. | — | Displayed when the optional model has two current transformer points. |

7 - 2 List of Parameter Setting Displays

| Display | Item | Contents | Initial value | Notes |
|---------|----------------------------|--|----------------|--|
| | AUTO/MANUAL mode selection | : AUTO mode : MANUAL mode | AUTO | Displayed when the control method is other than ON/OFF control (Ctrl ≠ 0). |
| | RUN/READY mode selection | : RUN mode : READY mode | RUN | |
| | AT Stop/Start selection | : AT stop : AT start | AT stop | Displayed when the control method is other than ON/OFF control (Ctrl ≠ 0). |
| | Release all DO latches | : Latch continue : Latch release | Latch continue | All DO latches such as control outputs (relay and voltage pulse) and events can be released. |
| | Communication DI1 | : OFF : ON | OFF | |
| | SP of LSP1 group | SP low limit (C07) to SP high limit (C08) | 0 | |
| | SP of LSP2 group | SP low limit (C07) to SP high limit (C08) | 0 | Displayed when [LSP system group] (C30) is "2" or more. |
| | SP of LSP3 group | SP low limit (C07) to SP high limit (C08) | 0 | Displayed when [LSP system group] (C30) is "3" or more. |
| | SP of LSP4 group | SP low limit (C07) to SP high limit (C08) | 0 | Displayed when [LSP system group] (C30) is "4" or more. |
| | Event 1 main setting | -1999 to +9999 The decimal point position may vary so that it meets the operation type. The above value becomes 0 to 9999 in some operation types. | 0 | Setting required by the event operation type is displayed. |
| | Event 1 sub setting | | 0 | |
| | Event 1 hysteresis | 0 to 9999 The decimal point position may vary so that it meets the operation type. | 5 | |
| | Event 2 main setting | Same as Event 1 main / sub setting | 0 | |
| | Event 2 sub setting | | 0 | |
| | Event 2 hysteresis | Same as Event 1 hysteresis | 5 | |

| Display | Item | Contents | Initial value | Notes |
|---------|--------------------------------|--|---------------|--|
| 0000 | Event 3 main setting | Same as Event 1 main / sub setting | 0 | |
| 0056 | Event 3 sub setting | | 0 | |
| 0089 | Event 3 hysteresis | Same as Event 1 hysteresis | 5 | |
| 0400 | Event 4 main setting | Same as Event 1 main / sub setting | 0 | |
| 0456 | Event 4 sub setting | | 0 | |
| 0489 | Event 4 hysteresis | Same as Event 1 hysteresis | 5 | |
| 0500 | Event 5 main setting | Same as Event 1 main / sub setting | 0 | |
| 0556 | Event 5 sub setting | | 0 | |
| 0589 | Event 5 hysteresis | Same as Event 1 hysteresis | 5 | |
| 0000 | Proportional band | 0.1 to 999.9% | 5.0 | Displayed when the control method is other than ON/OFF control (Ctrl ≠ 0). |
| 0000 | Integration time | 0 to 9999s | 120 | |
| 0000 | Derivative time | 0 to 9999s | 30 | |
| 0000 | Manual reset | -10.1 to +110.0% | 50.0 | Displayed when the control method is not the ON/OFF control (Ctrl ≠ 0) and the integration time (I-1) is 0 sec. |
| 0000 | P ((Proportional band) (cool)) | 0.1 to 999.9% | 5.0 | Displayed when the control method is not the ON/OFF control (Ctrl ≠ 0) and the heat/cool control is used (C26 = 1). |
| 0000 | I ((Integration time) (cool)) | 0 to 9999s | 120 | |
| 0000 | D ((Derivative time) (cool)) | 0 to 9999s | 30 | |
| 0000 | Control method | 0: ON/OFF control 1: Fixed PID 2: ST (Self-tuning) | 0 or 1 | The initial value is "0" when the control output 1 is the relay output. The initial value is "1" in other cases. |
| 0000 | MV low limit at AT | -10.0 to +110.0% | 0.0 | Displayed when the control method is other than ON/OFF control (Ctrl ≠ 0). |
| 0000 | MV high limit at AT | -10.0 to +110.0% | 100.0 | |
| 0000 | ON/OFF control differential | 0 to 9999 U | 5 | Displayed when the control method is the ON/OFF control (Ctrl = 0). |
| 0000 | PV filter | 0.0 to 120.0 s | 0.0 | |
| 0000 | PV bias | -1999 to +9999U | 0 | |
| 0000 | Time proportional cycle time 1 | 5 to 120s (when the output includes the relay output) 1 to 120s (when the output does not include the relay output) | 10 or 2 | When the output destination of the time proportional output 1 includes the relay output, the relay output is operated with time proportional cycle time of 5 sec. even though a value less than 5 sec. is set. |

Chapter 7. LIST OF SIMPLE CONFIGURATION DISPLAY ITEMS

| Display | Item | Contents | Initial value | Notes |
|---|---------------------------------------|--|---------------|---|
|  | Time proportional cycle time 2 (cool) | 5 to 120s (when the output includes the relay output) 1 to 120s (when the output does not include the relay output) | 10 or 2 | Displayed when the heat/cool control is used. When the output destination of the time proportional output 2 includes the relay output, the relay output is operated with time proportional cycle time of 5 sec. even though a value less than 5 sec. is set. |
|  | AT type | 0: Normal (Standard control characteristics) 1: Immediate response (Control characteristics immediately responding to the external disturbance.) 2: Stable (Control characteristics with less up/down fluctuation of PV) | 1 | Displayed when the control method is other than ON/OFF control (Ctrl ≠ 0). |

7 - 3 List of Setup Setting Displays



| Display | Item | Contents | Initial value | Notes |
|---------|---------------------------------|---|---------------|--|
| 0000 | PV input range type | When the PV input type is thermocouple: 1 to 6, 9 to 11, 13 to 21, 23 to 25 | 1 | For details, refer to the PV input range table (on page 5-3). |
| | | When the PV input type is RTD: 41 to 46, 51 to 54, 63, 64, 67, 68 | 41 | |
| | | When the PV input type is DC current/voltage: 84, 86 to 90 | 88 | |
| 0000 | Temperature unit | 0: Centigrade (°C) 1: Fahrenheit (°F) | 0 | Displayed when the PV input type is thermocouple or RTD. |
| 0000 | Decimal point position | 0: No decimal point 1 to 3: Digits after decimal point | 0 | Displayed when the PV input type (selected by the model number) is DC current/voltage, or when a thermocouple or RTD range with a decimal point is selected. |
| 0000 | PV input range low limit | When the PV input type is thermocouple or RTD, the setting is disabled and the input range low limit selected with the PV input type (C01) is displayed. | — | |
| | | When the PV input type is DC current/voltage, a value ranging from -1999 to +9999 is set. | 0 | |
| 0000 | PV input range high limit | When the PV input type is thermocouple or RTD, the setting is disabled and the input range high limit selected with the PV input type (C01) is displayed. | — | |
| | | When the PV input type is DC current/voltage, a value ranging from -1999 to +9999 is set. | 1000 | |
| 0000 | Control action (Direct/Reverse) | 0: Reverse action (Heat control) 1: Direct action (Cool control) | 0 | Displayed when the heat/cool control selection is not used (C26=0). |
| 0000 | Heat/Cool control selection | 0: Disabled. 1: Enabled. | 0 | Displayed when two control output points or event output is provided. |
| 0000 | Heat/Cool control deadband | -100.0 to +100.0% | 0.0 | Displayed when using the heat/cool control selection (C26=0). |
| 0000 | LSP system group | 1 to 4 | 1 | |
| 0000 | CT1 operation type | 0: Heater burnout detection 1: Current value measurement | 0 | Displayed when the optional model has two current transformer input points. |
| 0000 | CT1 output | 0: Control output 1 1: Control output 2 2: Event output 1 3: Event output 2 4: Event output 3 | 0 | Displayed when the optional model has two current transformer input points and the CT1 operation type is set at "heater burnout detection" (C36 = 0). |
| 0000 | CT1 measurement wait time | 30 to 300 ms. | 30 | Displayed when the optional model has two current transformer input points and the CT1 operation type is set at "heater burnout detection" (C36=0). |
| 0000 | CT2 operation type | 0: Heater burnout detection 1: Current value measurement | 0 | Displayed when the optional model has two current transformer input points. |
| 0000 | CT2 output | 0: Control output 1 1: Control output 2 2: Event output 1 3: Event output 2 4: Event output 3 | 0 | Displayed when the optional model has two current transformer input points and the CT2 operation type is set at "heater burnout detection" (C39 = 0). |

| Display | Item | Contents | Initial value | Notes |
|---------|-----------------------------|---|---------------|--|
| 00.40 | CT2 measurement wait time | 30 to 300 ms. | 30 | Displayed when the optional model has two current transformer input points and the CT2 operation type is set at "heater burnout detection" (C39=0). |
| 00.42 | Output 1 range | 1: 4 to 20 mA 2: 0 to 20 mA | 1 | Displayed when the control output 1 of the model is the current output. |
| 00.43 | Output 1 type | 0: MV 1: Heat MV (for heat/cool control) 2: Cool MV (for heat/cool control) 3: PV 4: PV value before bias 5: SP 6: Deviation 7: CT1 current value 8: CT2 current value 9: MFB (invalid on SDC15) 10: SP+MV 11: PV+MV | 0 | Displayed when the control output 1 of the model is the current output. The decimal point position of the output 1 low limit/high limit becomes 1 digit after the decimal point when the output 1 type is related to the MV and CT. When the output 1 type is related to the PV, SP, and deviation, the decimal point position becomes the same as that of the PV. |
| 00.44 | Output 1 scaling low limit | -1999 to +9999 (The decimal point position may vary depending on the output 1 type.) | 0.0 | |
| 00.45 | Output 1 scaling high limit | -1999 to +9999 (The decimal point position may vary depending on the output 1 type.) | 100.0 | |
| 00.46 | Control output 1 MV scaling | 0 to 9999 The decimal point position and unit are same as for PV. | 200 | If the controller model uses current output for control output 1 and if the control output 1 type is SP+MV or PV+MV, this setting is displayed. |
| 00.47 | Output 2 range | 1: 4 to 20 mA 2: 0 to 20 mA | 1 | Displayed when the control output 2 of the model is the current output. |
| 00.48 | Output 2 type | 0: MV 1: Heat MV (for heat/cool control) 2: Cool MV (for heat/cool control) 3: PV 4: PV value before bias 5: SP 6: Deviation 7: CT1 current value 8: CT2 current value 9: MFB (invalid on SDC15) 10: SP+MV 11: PV+MV | 3 | Displayed when the control output 2 of the model is the current output. The decimal point position of the output 2 input range low limit/high limit becomes 1 digit after the decimal point when the output 2 type is related to the MV and CT. When the output 2 type is related to the PV, SP, and deviation, the decimal point position becomes the same as that of the PV. |
| 00.49 | Output 2 scaling low limit | -1999 to +9999 (The decimal point position may vary depending on the output 2 type.) | 0 | |
| 00.50 | Output 2 scaling high limit | -1999 to +9999 (The decimal point position may vary depending on the output 2 type.) | 1000 | |
| 00.51 | Control output 2 MV scaling | 0 to 9999 The decimal point position and unit are same as for PV. | 200 | If the controller model uses current output for control output 2 and if the control output 2 type is SP+MV or PV+MV, this setting is displayed. |

⚠ Handling Precautions

- If ROM version 1 of the instrument information bank(1002) is prior to 2.04, SP+MV and PV+MV cannot be set in [Control output 1 type], [Control output 2 type], and [Auxiliary output type].
- If ROM version 1 of the instrument information bank(1002) is prior to 2.04, SP+MV and PV+MV cannot be set in [Control output 1 MV scaling], [Control output 2 MV scaling], and [Auxiliary output MV scaling].

| Display | Item | Contents | Initial value | Notes |
|---------|--|---|---------------|--|
| 0.000 | Communication mode | 0: CPL 1: MODBUS (ASCII format) 2: MODBUS (RTU format) | 0 | Displayed when the optional model has RS-485. |
| 0.000 | Station address | 0 to 127 Communication is disabled when "0" is set | 0 | Displayed when the optional model has RS-485. |
| 0.000 | Transmission speed | 0: 4800bps 1: 9600bps 2: 19200bps 3: 38400bps | 2 | Displayed when the optional model has RS-485. |
| 0.000 | Data format (Data length) | 0: 7 bits 1: 8 bits | 1 | Displayed when the optional model has RS-485 and the communication mode is not MODBUS (RTU) (C64 ≠ 2). |
| 0.000 | Data format (Parity) | 0: Even parity 1: Odd parity 2: No parity | 0 | Displayed when the optional model has RS-485. |
| 0.000 | Data format (Stop bit) | 0: 1 bit 1: 2 bits | 0 | Displayed when the optional model has RS-485. |
| 0.000 | [mode] key function | 0: Invalid 1: AUTO/MANUAL selection 2: RUN/READY selection 3: AT Stop/Start 4: LSP group selection 5: Release all DO latches 6: Invalid 7: Communication DI1 selection 8: Invalid | 0 | |
| 0.000 | User level | 0: Simple configuration 1: Standard configuration 2: High function configuration | 0 | |
| 0.000 | PV input failure (under range) type | 0: -10%FS 1: -5mV | 0 | If ROM version 1 of the instrument information bank is prior to 2.26, 0.00 cannot be selected. |









| Display | Item | Contents | Initial value | Notes |
|---|------------------------------------|--|---------------|-------|
|  | Operation type of internal event 1 | 0: No event 1: PV high limit 2: PV low limit 3: PV high/low limit 4: Deviation high limit 5: Deviation low limit 6: Deviation high/low limit 7: Deviation high limit (Final SP reference) 8: Deviation low limit (Final SP reference) 9: Deviation high/low limit (Final SP reference) 10: SP high limit 11: SP low limit 12: SP high/low limit 13: MV high limit 14: MV low limit 15: MV high/low limit 16: CT1 heater burnout/over-current 17: CT1 heater short-circuit 18: CT2 heater burnout/over-current 19: CT2 heater short-circuit 20: Loop diagnosis 1 21: Loop diagnosis 2 22: Loop diagnosis 3 23: Alarm (status) 24: READY (status) 25: MANUAL (status) 26: Invalid 27: During AT execution (status) 28: During SP ramp (status) 29: Control direct action (status) 30: During ST execution (status) 31: Invalid 32: Timer (status) 33: High and low limits of MFB value (Invalid in this unit) | 0 | |
|  | Internal event 1 | As described below. | 0000 | |
| | 1st digit: Direct/Reverse | 0: Direct 1: Reverse | 0 | |
| | 2nd digit: Standby | 0: None 1: Standby 2: Standby + Standby at SP change | 0 | |
| | 3rd digit: Operation at READY | 0: Continue 1: Forced OFF | 0 | |
| | 4th digit: Undefined | 0 | 0 | |

 Handling Precautions

- If ROM version 1 of the instrument information bank (~~1.002~~) is prior to 2.04, “33” cannot be set as [Internal Event configuration 1 operation type].

| Display | Item | Contents | Initial value | Notes |
|---------|--|--|---------------|--|
| | Operation type of internal event 2 | Same as operation type of internal event 1. | 0 | |
| | Internal event 2 1st digit: Direct/Reverse 2nd digit: Standby 3rd digit: Operation at READY 4th digit: Undefined | Same as internal event 1. | 0000 | |
| | Operation type of internal event 3 | Same as operation type of internal event 1. | 0 | |
| | Internal event 3 1st digit: Direct/Reverse 2nd digit: Standby 3rd digit: Operation at READY 4th digit: Undefined | Same as internal event 1. | 0000 | |
| | Operation type of internal event 4 | Same as operation type of internal event 1. | 0 | |
| | Internal event 4 1st digit: Direct/Reverse 2nd digit: Standby 3rd digit: Operation at READY 4th digit: Undefined | Same as internal event 1. | 0000 | |
| | Operation type of internal event 5 | Same as operation type of internal event 1. | 0 | |
| | Internal event 5 1st digit: Direct/Reverse 2nd digit: Standby 3rd digit: Operation at READY 4th digit: Undefined | Same as internal event 1. | 0000 | |
| | Operation type of internal contact 1 | 0: No function 1: LSP group selection (0/+1) 2: LSP group selection (0/+2) 3: LSP group selection (0/+4) 4: Invalid 5: Invalid 6: Invalid 7: RUN/READY selection 8: AUTO/MANUAL selection 9: Invalid 10: AT Stop/Start 11: ST disabled/enabled 12: Control action direct/reverse selection (As setting/opposite operation of setting) 13: SP RAMP enabled/disabled 14: PV Hold (No-hold/Hold) 15: PV maximum value hold (No-hold/Hold) 16: PV minimum value hold (No-hold/Hold) 17: Timer Stop/Start 18: Release all DO latches (Continue/Release) 19: Invalid 20: Invalid | 0 | For details, refer to the section, Internal contact operation type setup (on page 5-37). |

Chapter 7. LIST OF SIMPLE CONFIGURATION DISPLAY ITEMS

| Display | Item | Contents | Initial value | Notes |
|--|--------------------------------------|---|---------------|--|
|  | Operation type of internal contact 2 | Same as operation type of internal contact 1 | 0 | |
|  | Operation type of internal contact 3 | Same as operation type of internal contact 1 | 0 | |
|  | Key lock | 0: All settings are enabled. 1: Mode, event, operation display, SP, UF, lock, manual MV, and mode key can be set. 2: Operation display, SP, UF, lock, manual MV, and mode key can be set. 3: UF, lock, manual MV, and mode key can be set. | 0 | When two sets of passwords (1A and 1B, and 2A and 2B) are met, the settings can be made. Mode key setting, MV setting in the MANUAL mode, key lock, password display, and password 1A to 2B settings can be made when the key lock (LoC) is 0 to 3. |
|  | Password display | 0 to 15 5: Password 1A, 2A, 1B and 2B display | 0 | "0" is set whenever the power is turned ON. |
|  | Password 1A | 0000 to FFFF (hexadecimal value) | 0000 | Displayed when the password display (PASS) is "5" and two sets of passwords (1A and 1B, 2A and 2B) are met. |
|  | Password 2A | 0000 to FFFF (hexadecimal value) | 0000 | |
|  | Password 1B | 0000 to FFFF (hexadecimal value) | 0000 | Displayed when the password display (PASS) is "5". |
|  | Password 2B | 0000 to FFFF (hexadecimal value) | 0000 | |

Chapter 8. PID CONTROL TUNING

CAUTION



This unit incorporates the self-tuning function without use of control constant settings in addition to the ON/OFF control and conventional PID control. This self-tuning control monitors and studies the characteristics of the control subject even if the SP value is changed or external disturbance occurs in order to automatically calculate the control constants. This ensures stable control all the time.

With the control method [Ctrl] of the parameter setting, select a desired PID control tuning suitable for the required controllability or application.

0: ON/OFF control

The control is operated with the SP and differential settings ([dIFF]). The PID constants are not used.

1: Fixed PID

The control is operated with the fixed PID constants set by AT (auto tuning) or key operation.

2: ST (Self-tuning)

The PID constants are set automatically if the SP is changed or an external disturbance occurs.

8 - 1 AT (auto tuning) Function

The AT (auto tuning) function is used in the following cases:

- The PID constants are set automatically with the control method set at “Fixed PID” ([Ctrl] = 1).
- The PV rise is slow or overshoot is large in the control with the PID constants, which have been set automatically using the ST function.
- The PV rise becomes slow or overshoot becomes large with the control method set at ST ([Ctrl] = 1).

The AT function can be used when the control method is set at either “Fixed PID” ([Ctrl] = 1) or ST ([Ctrl] = 2).

■ Starting procedures

- (1) Make sure that the PV input or operation end (heater power, etc.) is controllable.
- (2) Make sure that the mode indicator [rdy] is off and the operation is in the RUN mode. If the indicator [rdy] is lit and the operation is in the READY mode, change the mode to the RUN mode.
With the default settings before shipment, when the [mode] key is kept pressed for 1 sec. or longer, the RUN/READY mode selection can be made.
- (3) Make sure that the mode indicator [man] is off and the operation is in the AUTO mode. If the indicator [man] is lit and the operation is in the MANUAL mode, change the mode to the AUTO mode.
With the default settings before shipment, the AUTO/MANUAL mode selection can be performed using the parameter setting, AUTO/MANUAL [A -- M].
- (4) Set the parameter setting [AT Stop/Start] to “AT start ([At] = [At.on])”.

■ Stopping procedures

The AT function is completed automatically. To stop the AT function, which is running, change the parameter setting [AT Stop/Start] to AT stop ([At] = [At.oF]). Additionally, the AT function is stopped when changing the READY mode to the MANUAL mode.

● Display during execution of AT

The decimal point at the 1st digit of the display No. 1 (right end digit) flashes twice repeatedly while the AT function is running. When the AT function is completed and the PID constants are changed, this LED goes off.

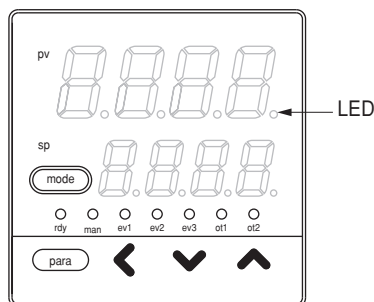

● Operation during execution of AT

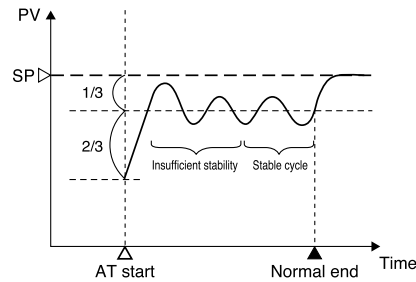

The AT function calculates the PID constants using the limit cycle.

- (1) When the AT function is started, a point, where the SP and PV deviations are split to “2:1”, is determined as ON/OFF change point of the MV (manipulated variable).
- (2) When the limit cycle is judged as stable, the PID constants are changed and the AT function is completed.

! Handling Precautions

- Before starting the AT function, put the PV input and/or operation end (heater power, etc.) in the controllable status.
- When the control method is set at “ON/OFF control” ([Ctrl] = 0), the AT function cannot be started. To operate the AT function, set the control method to “Fixed PID” ([Ctrl] = 1) or “ST” ([Ctrl] = 2).
- To start the AT, it is absolutely necessary that the operation is in the READY mode and AUTO mode, and no PV input errors occur.
- If the mode is changed to the READY mode or MANUAL mode or if the PV input error or power failure occurs during execution of the AT function, the AT function is stopped without changing of the PID constants.
- The number of limit cycles and period of time from the AT start to AT end may vary depending on the control subject.
- The MV ON and OFF are repeated several times during execution of the AT function to perform the limit cycle. (The OFF operation described here means MV limited by the MV low limit at AT ([At.oL]) or MV high limit at AT ([oL]). The default setting before shipment is “0%”. Additionally, the ON operation described here means MV limited by the MV high limit at AT ([At.oH]) or MV high limit at AT ([oH]). The default setting before shipment is “100%”. If this AT operation does not function correctly, take any of the following measures:
 - (1) Change the MV low limit at AT ([At.oL]) or MV high limit at AT ([At.oH]) to an appropriate value, and then start the AT function.
 - (2) Use the ST function.
 - (3) Set the PID constants manually without use of AT.
- Appropriate PID constants cannot be obtained depending on the control subject. If this happens, set the PID constants manually.
- The MV ON/OFF change point determined when the AT function is started does not change even though the SP is changed while the AT is running.

8 - 2 ST (Self-tuning) Function

When the following ST start conditions are satisfied with the control method set at ST ([Ctrl] = 2), the ST function is started automatically to change the PID constants.

(1) ST start by SP change

If the SP is changed in the RUN mode, the ST function is started.

However, if the SP change width is small or if the difference between the SP and PV is small, the ST is not started.

(2) ST start by deviation occurrence

If the difference between the SP and PV is large during control in the RUN mode, the ST is started. If the difference between the SP and PV is large when the READY mode is changed to the RUN mode, the ST is started.

If the difference between the SP and PV is large when the control is started in the RUN mode after the power has been turned ON, the ST is started.



Handling Precautions

- To start the ST, it is necessary that the integration time of the PID constant is not "0" ($[I - 1] \neq 0$) and the derivative time is not "0" ($[d - 1] \neq 0$).
- To start the ST, it is necessary that the mode is the RUN mode and AUTO mode.
- To set the SP change width or the reference value used to judge large/small difference between the SP and PV, it is necessary to set "High function configuration". However, the default settings before shipment apply to most control subjects.
- When using the heat/cool control, the ST cannot be used.

■ Starting procedures

- (1) Make sure that the PV input or operation end (heater power, etc.) is controllable.
- (2) Make sure that the mode indicator [rdy] is off and the operation is in the RUN mode. If the indicator [rdy] is lit and the operation is in the READY mode, change the mode to the RUN mode.
- (3) Make sure that the mode indicator [man] is off and the operation is in the AUTO mode. If the indicator [man] is lit and the operation is in the MANUAL mode, change the mode to the AUTO mode.
- (4) Set the control method of the parameter setting to ST ([Ctrl] = 2).
- (5) Set the SP.

If the ST is not started since the PV is close to the SP ($PV \approx SP$), use the SP value, which is greatly different from the PV value.

■ Stopping procedures

The ST is completed automatically. If it is necessary to stop the ST halfway during execution of the ST or not to start the ST during stopping of the ST, set the control method of the parameter setting to “Fixed PID” ([Ctrl] = 1). Additionally, if the mode is changed to the READY mode or MANUAL mode, the ST is also stopped.

● Display during execution of ST

The LED of the decimal point at the 1st digit (right end digit) of the display No. 1 is flashing while the ST is running.

When the ST is completed and PID constants are changed, this LED goes off.

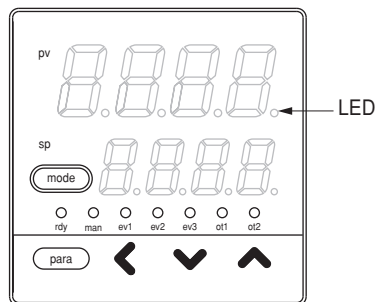

8 - 3 Precautions for ST (Self-tuning)

When using the ST function, the following cautions must be observed strictly:

- Before starting the ST function, put the PV input and operation end (heater power, etc.) in the controllable status.
- Before starting the ST function, set the PID constants so that the PID control can be performed correctly.
 - The default settings before shipment are that the proportional band [P-1] = 5.0%, integration time [I-1] = 120s, and derivative time [d-1] = 30s. These default settings apply to the PID control of almost all general control subjects.
 - When the integration time [I-1] = 0s, the ST is not started.
 - When the derivative time [d-1] = 0s, the ST is not started.
- To stop the control with the power to the controller kept turned ON, change the mode to the READY mode and stop the operation at the operation end (turn OFF the heater power). Additionally, to restart the control, start the operation at the operation end (turn ON the heater power), and then change the mode to the RUN mode.

! Handling Precautions

- If any cautions described above are not observed, the PID constants are changed to incorrect values when the ST is completed. This may cause poor control results.
- When the power to the controller is turned OFF while the ST is running (LED is flashing), the PID constants are not changed. Additionally, if the power is turned OFF immediately before the ST is completed, incorrect PID constant values are set.

If the PID constant values become incorrect, follow the steps below to reset them.

- (1) Return the PID constants to their default values. (Make the settings so that proportional band [P-1] = 5.0%, integration time [I-1] = 120s, and derivative time [d-1] = 30s.)
- (2) Start the ST, or set the PID constants using the AT function, and then start the ST.

● Control subject of interference system

There are adjacent control subjects in the horizontal and vertical directions. Each temperature change adversely affects the mutual ST functions and the response latency of the control may be delayed. In this case, the unit is operated with the control method set at "Fixed PID" ([Ctrl] = 1).

● Control subject producing external disturbance intermittently

If the customer's system produces the temperature drop intermittently, such as sealing of the wrapping machine, this may affect the ST adversely.

In this case, the unit is operated with the control method set at "Fixed PID" ([Ctrl] = 1).

Chapter 9. MAINTENANCE AND TROUBLESHOOTING

■ Maintenance

● Cleaning

When removing the dirt from the measuring instrument, wipe it off with a soft cloth rag. At this time, do not use any organic solvent, such as paint thinner or benzene.

● Part replacement

Do not replace any parts of this unit.

● Fuse replacement

When replacing the fuse connected to the electric wiring, always use the specified standard fuse.

| | |
|-----------------|----------------------|
| Standard | IEC127 |
| Shut-down speed | Slow-action type (T) |
| Rated voltage | 250V |
| Rated current | 0.2A |

■ Alarm display and corrective action

The following table shows the alarm displays and corrective actions if any failure occurs in this unit:

| Alarm code | Failure name | Cause | Corrective action |
|------------|--|--|---|
| AL01 | PV input failure (Over-range) | Sensor burnout, incorrect wiring, incorrect PV input type setting | Check the wiring. Check the PV input type setting. |
| AL02 | PV input failure (Under-range) | Sensor burnout, incorrect wiring, incorrect PV input type setting | |
| AL03 | CJ failure | Terminal temperature is faulty (thermocouple). | Use the unit at an ambient temperature meeting the operating conditions stated in the specification. |
| | PV input failure | Sensor burnout, incorrect wiring (RTD) | Check the wiring. |
| AL11 | CT input failure (over-range) (CT input 1 or 2, or both) | A current exceeding the upper limit of the display range was measured. The number of CT turns or the number of CT power wire loops is incorrectly set, or wiring is incorrect. | <ul style="list-style-type: none"> • Use a CT with the correct number of turns for the display range. • Reset the number of CT turns. • Reset the number of CT power wire loops. • Check the wiring. |
| AL70 | A/D conversion failure | A/D converter is faulty. | It is thought that the main body needs to be replaced. Contact the azbil Group or its dealer. |
| AL95 | Set data failure | Data is corrupted by noise. Power is shut-down while the data is being set. | Turn ON the power again. If the same alarm occurs after that, set the data (set data for AL95/97 and adjustment data for AL96/98) and turn ON the power again. If the same alarm occurs again even after the above steps have been taken, the main body needs to be replaced. Contact the azbil Group or its dealer. |
| AL96 | Adjustment data failure | Power is shut-down while the data is being set. Data is corrupted by noise. | |
| AL97 | Set data failure (RAM area) | Data is corrupted by noise. | |
| AL98 | Adjustment data failure (RAM area) | Data is corrupted by noise. | |
| AL99 | ROM failure | ROM (memory) is faulty. | Turn ON the power again. If the same alarm occurs again, the main body needs to be replaced. Contact the azbil Group or its dealer. |

⚠ Handling Precautions

- If ROM version 1 of the instrument information bank (AL02) is prior to 2.04, CT input failure (AL11) is not displayed.

■ **Operation in case of PV input failure**

(1) AL01, 02, or 03 occurs.

Control output: It is possible to make the settings so that the operation is continued or discontinued.

Other operation: Operation is continued.

(2) Alarm occurs in cases other than those shown above.

All operations are continued.

The following table shows the indications and alarms of this unit by the sensor type if PV input failure occurs:

● **Thermocouple**

| Failure status | Range No. | Indication value | Alarm code |
|---------------------|-----------|---|------------|
| Sensor burnout | | Upscale (110%FS) | AL01 |
| CJ failure | | PV having incorrect cold contact compensation | AL03 |
| Over-range, burnout | 19 (PLII) | 1365°C (105%FS) | AL01 |

● **RTD**

| Failure status | Range No. | Indication value | Alarm code |
|---|-------------|--------------------|------------|
| RTD burnout | | Upscale (110%FS) | AL01 |
| A-wire burnout | | Upscale (110%FS) | AL01 |
| B-wire burnout | | Upscale (110%FS) | AL01, AL03 |
| C-wire burnout | | Upscale (110%FS) | AL01, AL03 |
| 2- or 3-wire burnout | | Upscale (110%FS) | AL01, AL03 |
| A- and B-wire short-circuit | | Downscale (-10%FS) | AL02 |
| A- and C-wire short-circuit | | Downscale (-10%FS) | AL02 |
| A- and B-wire/A- and C-wire short-circuit | 41 (Pt100) | -235°C (-5%FS) | AL02 |
| A- and B-wire/A- and C-wire short-circuit | 42 (JPt100) | -235°C (-5%FS) | AL02 |

● **DC voltage/DC current**

| Failure status | Range No. | Indication value | Alarm code |
|----------------|----------------|----------------------------|------------|
| Burnout | 84 (0 to 1V) | Downscale (-3%FS) | AL02 |
| | 86 (1 to 5V) | Downscale (-10%FS) | AL02 |
| | 87 (0 to 5V) | Downscale (-3%FS) | AL02 |
| | 88 (0 to 10V) | Downscale (0%FS) | None |
| | 89 (0 to 20mA) | Indefiniteness (near 0%FS) | None |
| | 90 (4 to 20mA) | Downscale (-10%FS) | AL02 |

Chapter 10. DISPOSAL

When disposing of this unit, dispose of the unit properly as industrial waste according to the applicable laws and regulations specified by the local governmental office.

Chapter 11. SPECIFICATIONS

■ Specifications

● PV input

| | |
|--|--|
| Thermocouple: | K, J, E, T, R, S, B, N (JIS C1602-1995) PL II (Engelhard Industries Data (ITS90)) WRe5-26 (ASTM E988-96 (Reapproved 2002)) PR40-20 (Johnson Matthey Data) DIN U, DIN L (DIN 43710-1985) |
| Resistance temperature detector (RTD): | Pt100 (JIS C1604-1997) JPt100 (JIS C1604-1989) |
| DC voltage: | 0 to 1V, 1 to 5V, 0 to 5V, 0 to 10V |
| DC current: | 0 to 20mA, 4 to 20mA |
| Sampling cycle time: | 500ms |
| Indication accuracy: | $\pm 0.5\%FS \pm 1$ digit, $\pm 1\%FS \pm 1$ digit in the negative area of the thermocouple. $\pm 0.5\%FS \pm 2$ digits, or $\pm 1\%FS \pm 2$ digits in the negative area if the thermocouple range is displayed with a decimal point (Specified by the input conversion at an ambient temperature of $23 \pm 2^\circ C$) However, the accuracy of the B-thermocouple is $\pm 5\%FS$ at a temperature of $260^\circ C$ or less and $\pm 1\%FS$ at a temperature of 260 to $800^\circ C$. If ROM version 1 of the instrument information bank (1.002) is prior to 2.04, the value is $-180^\circ C$. |
| PV bias: | -1999 to +9999 or -199.9 to +999.9 |

• T/C input

| | |
|------------------------------------|--|
| Input bias current: | +0.2 μA (Flowed from the A terminal.) |
| Burnout indication: | Upscale + AL01 |
| Thermocouple or compensating wire: | 0.3 to 0.65mm diameter |
| Allowable input voltage: | -0.5 to +12V |

Note: When the dedicated loader cable is connected to the SDC15, the temperature characteristics of the controller may be affected, but control is not.

• RTD input

| | |
|------------------------------|---|
| Input bias current: | Approx. +1mA (Flowed from the A terminal.) |
| Burnout indication: | RTD burnout or A-wire burnout Upscale + AL01 B-wire burnout or C-wire burnout . . Upscale + AL01, AL03 2 or more wires burnout Upscale + AL01, AL03 |
| Allowable wiring resistance: | 10 Ω or less for range No.51 to 64 85 Ω or less for range other than above range |
| Effect of wiring resistance: | Max. $\pm 0.05\%FS/\Omega$ |

• DC voltage input

| | |
|---------------------|--|
| Input impedance: | Min. 1M Ω |
| Input bias current: | 0 to 1V range 1 μA (sucked to the A terminal) 0 to 5V, 1 to 5V range 3.5 μA (sucked to the A terminal) 0 to 10V range 7 μA (sucked to the A terminal) |
| Burnout indication: | Downscale + AL02 However, the burnout cannot be detected in a range of 0 to 10V. |

• DC current input

| | |
|--------------------------|--|
| Input impedance: | Max. 100 Ω |
| Burnout indication: | Downscale + AL02 However, the burnout cannot be detected in a range of 0 to 20mA. |
| Allowable input current: | Max. 30mA |
| Allowable input voltage: | Max. 4V (a higher voltage might cause device failure) |

● **Control output**

• **Relay output**

Output rating: Control output 1 NO side 250Vac/30Vdc, 3A (resistance load)
 Control output 2 NC side 250Vac/30Vdc, 1A (resistance load)
 Life: 50,000 cycles or more on NO side
 100,000 cycles or more on NC side
 Min. open/close specifications: 5V, 100mA
 Min. open time
 close time: 250ms

• **Voltage pulse output (For SSR drive)**

Open voltage: 19Vdc±15%
 Internal resistance: 82Ω±0.5%
 Allowable current: Max. 24mAdc
 OFF leak current: Max. 100μA
 Min. OFF time/ON time: 1ms when the time proportional cycle time is less than 10s.
 250ms when the time proportional cycle time is more than 10s.

• **Current output**

Output type: 0 to 20mAdc or 4 to 20mAdc (current output)
 Allowance load resistance: Max. 600Ω
 Output accuracy: ±0.5%FS (under standard conditions)
 However, ±1.0%FS in a range of 0 to 1mA.

● **Event relay output**

Number of output points: 0 to 3 points (This may vary depending on the model.)
 Output type: SPST contact 3 points, Common 2 points, Each individual point
 Output rating: 250Vac/30Vdc, 2A (Resistance load)
 Service life: 100,000 cycles or more
 Min. open/close specifications: 5V, 10mA (Reference value)

● **Digital input**

Number of input points: 2 points
 Input type: No-voltage contact or open collector
 Allowable ON contact resistance: Max. 250Ω
 Allowable OFF contact resistance: Min.100 kΩ
 Allowable ON-state residual voltage: Max. 1.0V
 Open terminal voltage: 5.5Vdc ± 1V
 ON terminal voltage: Approx. 7.5mA (at short-circuit), Approx. 5.0mA (at contact resistance of 250Ω)
 Minimum hold time: 1s or more

● **Current transformer input**

Number of input points: 2 points
 Input object: Current transformer with 100 to 4,000 turns (availability is by 100-turn units)
 Optional unit Model No.: QN206A* (800 turns, hole diameter: 5.8 mm)
 Optional unit Model No.: QN212A* (800 turns, hole diameter: 12mm)
 * Not UL-certified.
 Current measurement lower limit: 0.4Aac (800 turns, 1 time)
 Formula; Number of turns ÷ (2000 x number of power wire loops)
 Current measurement upper limit: 50.0Aac (800 turns, 1 time)
 Formula; Number of turns ÷ (16 x number of power wire loops)
 Allowable measured current: 70.0Aac (800 turns, 1 time)
 Formula; Number of turns ÷ (16 x number of power wire loops) x 1.4

| | |
|----------------------------|---|
| Display range lower limit: | 0.0Aac |
| Display range upper limit: | 70.0Aac (800 turns, 1 time) Formula; Number of turns ÷ (16 x number of power wire loops) x 1.4 |
| Display accuracy: | ±5%FS |
| Display resolution: | 0.1Aac |

- **RS-485 communication**

| | |
|-----------------------------|--|
| Transmission line: | 3-wire method |
| Transmission speed: | 4800, 9600, 19200, 38400 bps |
| Communication distance: | Max. 500m |
| CPL/MODBUS: | Half duplex, start/stop synchronization method |
| Communication protocol: | In conformity with CPL and MODBUS |
| Number of connection units: | Max. 31 units |
| Terminating resistor: | Connection prohibited. |

- **Loader communication**

| | |
|---------------------|-------------------------------|
| Transmission line: | 3-wire method |
| Transmission speed: | Fixed at 19200 bps. |
| Recommended cable: | Included with the SLP-C35J50. |

- **Isolation between input and output**

Portions enclosed by solid lines are insulated from other signals.

| | | | |
|----------------------|------------------|------------------|----------------|
| Power supply | Internal circuit | Control output 1 | |
| PV input | | Control output 2 | |
| CT input 1 | | Event output 1 * | |
| CT input 2 | | | |
| Loader communication | | | |
| Digital input 1 | | Event output 2 * | |
| Digital input 2 | | | |
| RS-485 communication | | | |
| | | | Event output 3 |

Whether or not inputs and outputs are provided may vary depending on the model.

* In case of the independent contacts, the output 1 and the output 2 are isolated.

- **Environment conditions**

- **Standard conditions**

| | |
|-----------------------|---|
| Ambient temperature: | 23±2°C |
| Ambient humidity: | 60±5%RH |
| Power supply voltage: | AC power model, 105Vac±1%, 50/60Hz±1Hz DC power model, 24Vac±1%, 50/60Hz±1Hz 24Vdc±5% |
| Vibration: | 0m/s ² |
| Shock: | 0m/s ² |
| Mounting angle: | (Reference plane) ±3° |

- **Operating conditions**

| | |
|-----------------------|--|
| Ambient temperature: | 0 to 50°C (0 to 40°C for tight-mounting) |
| Ambient humidity: | 10 to 90%RH (No condensation allowed.) |
| Power supply voltage: | AC power model, 85 to 264Vac, 50/60Hz±2Hz (Rating: 100 to 240Vac, 50/60Hz) DC power model, 21.6 to 26AVac, 50/60Hz±2Hz/21.6 to 52.8Vdc (Rating: 24Vac, 50/60Hz 24 to 48Vdc) |
| Vibration: | 0 to 2m/s ² (10 to 60Hz for 2 hrs. in each of the X-, Y-, and Z-direction) |
| Shock: | 0 to 10m/s ² |
| Mounting angle: | (Reference plane) ±10° |

• **Transportation conditions**

Ambient temperature: -20 to +70°C
 Ambient humidity: 10 to 95%RH (No condensation allowed.)

● **Other specifications**

Degrees of protection: Front panel of the unit conforms to IP66/NEMA 4X.
 (Individual panel mounting with attached gaskets)
 (NEMA4: Equivalent, but non-UL certified)

Power consumption: AC power model, Max. 12VA (8VA at 100Vac and 12VA at 264Vac)
 (When using the functions similar to those of Azbil Corporation's SDC10, the power consumption is 6VA at 100Vac and 9VA at 264Vac.)
 DC power model, Max. 7VA (24Vac), Max. 5W (24 to 48Vdc)

Altitude: 2000m or less

Insulation resistance: Between power supply terminal and secondary terminal, 500Vdc, 20MΩ or more

Dielectric strength: AC power model, Between power supply terminal and secondary terminal, 1500Vac for 1 min.
 DC power model, Between power supply terminal and secondary terminal, 500Vac for 1min.

Inrush current at power ON: AC power model, Max. 20A
 DC power model, Max. 20A

Mass: Panel mounting type Approx. 150g (including mounting bracket)
 Socket mounting type Approx. 200g (including socket)

Terminal screw tightening torque: Panel mounting type 0.4N·m or less
 Socket mounting type 0.78 to 0.98N·m or less

Applicable standards: CE; EN61010-1,
 EN61326-1 (For use in industrial locations)
 During EMC testing, the reading or output may fluctuate by ±10%FS.

Over-voltage category: Category II (IEC60364-4-443, IEC60664-1)

Allowable pollution degree: Pollution degree 2

Decoration sheet material/color: Polyester film/Dark gray (DK546)

Case material/color: Reformed PPE/Light gray (DIC650)

Non-detected power failure time: AC power model, Max. 20ms
 DC power model, no power failure allowed

■ **Accessories and optional parts**

| Name | Model No. |
|---|--------------------------|
| Mounting bracket (For C15T) | 81409651-001 (Accessory) |
| Gasket | 81409657-001 (Accessory) |
| Current transformer (800 turns, Hole diameter: 5.8mm) | QN206A* |
| Current transformer (800 turns, Hole diameter: 12mm) | QN212A* |
| Socket (For C15S) | 81446391-001 |
| Hard cover | 81446442-001 |
| Soft cover | 81446443-001 |
| Terminal cover | 81446898-001 |
| Smart Loader Package | SLP-C35J50 |
| L-shaped plug adaptor | 81441057-001 |

* Not UL-certified.

Appendix

Glossary

Abbreviations are used in the descriptions, tables, and figures in this manual. The following shows the main abbreviations:

| | |
|-----|--|
| AT | Auto Tuning |
| CT | Current Transformer |
| DI | Digital Input |
| DO | Digital Output (Control outputs of relay and voltage pulse, and event output) |
| EV | Event |
| LSP | Local Set Point. The meaning of LSP and SP is same in case of the SDC15. |
| MFB | Motor Feed Back. This indicates the feed back of motor opening which is used for position proportional control. (This controller does not have MFB function.) |
| MV | Manipulated Variable |
| PV | Process Variable |
| RSP | Remote Set Point. This is the set point which is set by the analog input from an external device. (This controller does not have RSP function.) |
| SP | Set Point |
| ST | Self-Tuning |
| U | Unit. This indicates the minimum digit of the selected PV input range with industrial unit (°C, Pa, l/min., etc.). 1U = 1°C in a range of -200 to +200°C. 1U = 0.1°C in a range of 0.0 to 200.0°C. Additionally, 1U = 0.01 when the DC voltage input is scaled to 0.00 to 10.00. Furthermore, 0.1U means 1/10 of 1U. |

Index

-Number-

- 3-wire system..... 4-5
- 5-wire system..... 4-6

-A-

- Accessories..... 1-3
- Alarm..... 5-18
- Alarm display..... 9-1
- Analog output process..... 2-1
- Applicable standards..... 11-3
- AT function..... 8-2
- AT progress display..... 6-5
- AT start..... 8-2
- AT Stop/Start..... 6-9
- AT type..... 6-24
- Auto tuning..... 6-9
- AUTO/MANUAL mode..... 6-7

-C-

- CE marking..... 1-1
- Centigrade..... 5-4
- Communication mode setup..... 5-30
- Communication status..... 1-5
- Connection of communication..... 4-5
- Console..... 1-4, 2-2
- Constant current type..... 4-7
- Continuous output..... 5-26
- Control action..... 5-18
- Control action (Direct/Reverse) setup..... 5-8
- Control method setup..... 5-7
- Control output..... 2-1
- Control subject of interference system..... 8-6
- Control subject producing external disturbance... 8-6
- Cool MV..... 6-5
- CR filter..... 4-9
- Crimp type terminal lug..... 4-4
- CT input..... 5-24
- CT input display..... 6-6
- CT output..... 5-24
- CT output setup..... 5-25
- CT type..... 5-24
- CT wait time before measurement setup..... 5-26
- Current transformer..... 1-3
- Current transformer display..... 6-6
- Current transformer input..... 2-1

-D-

- Data format setup..... 5-33, 5-34, 5-35
- Data setting procedures..... 2-3
- Data length setup..... 5-33
- Decimal point position setup..... 5-5
- Dedicated cable..... 1-5
- Deviation high limit..... 5-13
- Deviation high/low limit..... 5-13
- Deviation low limit..... 5-13
- Derivative time..... 6-14
- Derivative time - Cool setup..... 6-18
- DI assignment..... 5-39
- Digital input..... 2-1, 4-5, 5-36, 5-39, 6-11
- Digital output..... 6-10
- Digital output process..... 2-1
- DIN rail..... 3-6
- During AT..... 5-18
- During SP ramp..... 5-18

-E-

- Event Direct/Reverse setup..... 5-20
- Event hysteresis setup..... 5-23
- Event main setting setup..... 5-21
- Event operation..... 5-13
- Event operation type setup..... 5-19
- Event output..... 2-1
- Event sub-setting setup..... 5-22
- External dimensions..... 3-2
- External resistor..... 4-8

-F-

- Fahrenheit..... 5-4
- Fuse..... 9-1

-G-

- Gang-mounting..... 3-2
- Gasket..... 1-3, 3-3

-H-

- Hard cover..... 1-3, 3-4
- Heat MV..... 6-5
- Heat/Cool control dead band setup..... 5-10
- Heat/Cool control selection setup..... 5-9
- Heater burnout..... 5-14

-I-

IEC directive 1-1

Immediate response 6-24

Installation category..... 11-3

Installation place..... 3-1

Integral time - Cool setup..... 6-17

Integral time setup 6-13

Internal contact operation type 5-39

Internal event..... 5-13, 5-19, 5-20, 5-21, 5-22

Isolation..... 11-3

-J-

Just-FiTTER..... 1-1

-K-

Key lock setup..... 6-25

-L-

Line filter 4-10

Loader connector..... 1-5

Loop diagnosis 5-15, 5-16, 5-17

Lower display 1-5, 2-2

LSP No. setup 6-2

LSP system group setup..... 5-12

-M-

Manual reset..... 6-15

Mode indicator..... 1-5

[mode] key function..... 5-37

[mode] key operating procedures..... 2-5

Mode selection 6-7, 6-8

Model selection table..... 1-2

Mounting bracket 3-3

Mounting procedures..... 3-3

Multi-function configuration..... 1-5

MV 6-4

MV at auto tuning..... 6-23

MV low limit..... 5-14

MV low limit/high limit at AT 6-23

MV high/low limit 5-14

MV high limit 5-14

MV scaling range 5-30

-N-

Noise preventive measures..... 4-10

Normal..... 6-24

Number of connectable units..... 4-7

-O-

ON/OFF control differential setup..... 6-19

Operation mode..... 2-6

Operation display 7-1

Optional parts..... 1-3

Output range setup 5-27

Output scaling low limit setup 5-29

Output scaling high limit setup..... 5-29

Output type setup 5-28

-P-

Password display setup..... 6-27

Password lock function..... 6-26

Password setup 6-28

Panel mount type 1-2, 1-6

Parameter setting display 7-7

Parameter setting display mode 5-2

Parity setup..... 5-35

Phase angle control..... 4-2

Proportional band - Cool setup..... 6-16

Proportional band setup 6-12

PID 6-12

PID control tuning 8-1

PV bias 6-21

PV filter..... 6-20

PV high limit..... 5-13

PV high/low limit..... 5-13

PV input..... 2-1

PV input range high limit setup 5-6

PV input range low limit setup 5-6

PV input range table..... 5-3

PV low limit..... 5-13

PV range type setup 5-2

-R-

RationalLOOP..... 1-1

Resistor type..... 4-10

RUN/READY mode..... 6-8

-S-

| | |
|----------------------------|---------------|
| Sampling cycle time..... | 11-1 |
| Self-tuning function..... | 8-4 |
| Setup setting display..... | 7-5 |
| Simple configuration..... | 2-1 |
| Socket..... | 3-2 |
| Socket mounting type..... | 1-2, 1-6, 3-2 |
| Socket part..... | 1-6 |
| Soft cover..... | 1-3, 3-5 |
| SP high/low limit..... | 5-14 |
| SP high limit..... | 5-13 |
| SP low limit..... | 5-14 |
| SP setup..... | 6-1 |
| SSR..... | 4-7 |
| ST function..... | 8-4 |
| ST setting standby..... | 5-18 |
| Stable..... | 6-24 |
| Stand-alone mounting..... | 3-2 |
| Station address setup..... | 5-31 |
| Stop bit setup..... | 5-36 |
| Stopper..... | 3-2, 3-6 |

-T-

| | |
|-----------------------------------|---------------|
| Terminal assignment label..... | 4-2 |
| Terminal cover..... | 1-3, 4-2 |
| Terminal part..... | 1-6 |
| Terminating resistor..... | 4-2, 4-5, 4-6 |
| Temperature unit setup..... | 5-4 |
| Tightening torque..... | 11-3 |
| Time proportional cycle time..... | 6-22 |
| Transmission speed setup..... | 5-33 |

-U-

| | |
|-----------------------|----------|
| Upper display..... | 1-5, 2-2 |
| User level setup..... | 5-38 |

-V-

| | |
|--------------------------------|-----|
| Voltage between terminals..... | 4-7 |
|--------------------------------|-----|

-W-

| | |
|--------------------------|-----|
| Waterproof mounting..... | 3-3 |
|--------------------------|-----|

Revision History

| Printed date | Manual Number | Edition | Revised pages | Description |
|--------------|---------------|-------------|---|--|
| July 2003 | CP-SP-1147E | 1st Edition | | |
| Dec. 2003 | | 2nd Edition | | Overall revision. |
| Dec. 2004 | | 3rd Edition | 1-6,4-2 4-7 11-1 11-4 | Panel mount type The tightening torque of the terminal screw 0.4N•m or less→0.4 to 0.6N•m changed. 1. Yamatake's PGM10N/PGM10F series added. A standard of temperature sensor about input type added. •RTD input Allowable wiring resistance, Effect of wiring resistance added. •DC voltage input Input impedance added. ●Non-detected power failure time added. |
| May 2006 | | 4th Edition | Cover, v 3-2 3-3 3-4 4-5 4-11 5-3 5-18 5-28 5-30 5-31 to 5-40 7-1 7-6 7-8 7-10 9-1 11-1 11-2 11-4 | Manual name changed. Handling precautions item added. Plate thickness: more than 2mm→9mm or less changed. Handling precautions item added. Handling precautions item added. Wiring diagram of ■Connection of open collector output to digital input changed. Section 4-2 Recommended Cables added. PV range tables totally changed. Set value of operation type 33 added. Explanation added. ■MV scaling range added. Old 5-30 to 5-39 pages. Display Ct2 deleted. C43 contents 10, 11 added. C46, C51 added. Handling Precautions added. Display E1.C1 Contents 33 added. Handling Precautions added. Old 7-9 page. ■Alarm displays and corrective action AL11 added. Handling Precautions added. Indication accuracy explanation added. Diameter of the applicable thermocouple or compensating wire added. Allowable input current added. ●Current transformer input changed. Dust-proof and drip-proof performance to degrees of protection changed. |
| Oct. 2007 | | 5th Edition | i v 1-3 5-3 11-1 11-4 | APPLICABLE STANDARDS: EN61326-1→EN61326 changed. Description on SDC15 Quick Reference Guide added. L-shaped plug adaptor added. ●PV input range table (Thermocouple): 7 of C01 set value deleted. Allowable input voltage added on DC current input. Applicable standards: EN61326-1→EN61326 changed. |
| Apr. 2012 | | 6th Edition | | Company name changed. |

| Printed date | Manual Number | Edition | Revised pages | Description |
|--------------|---------------|-------------|---|---|
| Nov. 2013 | CP-SP-1147E | 7th Edition | i, 3-1 i, 1-1, 11-4 3-1 4-2 5-3 5-11 7-5 11-1 End of the manual | Specifications of common mode voltage to the ground were changed. In the description of standards compliance, EN61326 was changed to EN 61326-1. A location was added to "Installation place." Wiring Precautions were changed. The "PV input range table (Thermocouple)" was changed. Note 3 was added. Handling Precaution was added. Descriptions of the figures were changed. The note for "C04" was changed. Specifications for PV input were changed. A note was added to the specifications for T/C input. Terms and Conditions were changed (to version No. AA511A-014-03). |
| Mar. 2014 | | 8th Edition | 1-3, 11-2, 11-4 4-10 | A note was added to the specifications for current transformer input. Azbil Corporation's line filter model No. was changed. |
| Jan. 2016 | | 9th Edition | Cover i i, 11-4 1-2, 5-3, 7-5, 11-1 1-2 1-3, 11-4 11-4 End of the manual | A notice saying "Not for use in Japan" was added. 200mA was changed to 0.2A. EQUIPMENT CONDITIONS was changed. Applicable standards was changed. Input type PR40-20 was added. "Model selection table" table was changed. Mounting bracket model No. was changed. Degrees of protection was changed. Terms and Conditions were changed (to version No. AA511A-014-06). |
| | | | | |

Terms and Conditions

We would like to express our appreciation for your purchase and use of Azbil Corporation's products. You are required to acknowledge and agree upon the following terms and conditions for your purchase of Azbil Corporation's products (system products, field instruments, control valves, and control products), unless otherwise stated in any separate document, including, without limitation, estimation sheets, written agreements, catalogs, specifications and instruction manuals.

1. Warranty period and warranty scope

1.1 Warranty period

Azbil Corporation's products shall be warranted for one (1) year from the date of your purchase of the said products or the delivery of the said products to a place designated by you.

1.2 Warranty scope

In the event that Azbil Corporation's product has any failure attributable to azbil during the aforementioned warranty period, Azbil Corporation shall, without charge, deliver a replacement for the said product to the place where you purchased, or repair the said product and deliver it to the aforementioned place.

Notwithstanding the foregoing, any failure falling under one of the following shall not be covered under this warranty:

- (1) Failure caused by your improper use of azbil product (noncompliance with conditions, environment of use, precautions, etc. set forth in catalogs, specifications, instruction manuals, etc.);
- (2) Failure caused for other reasons than Azbil Corporation's product;
- (3) Failure caused by any modification or repair made by any person other than Azbil Corporation or Azbil Corporation's subcontractors;
- (4) Failure caused by your use of Azbil Corporation's product in a manner not conforming to the intended usage of that product;
- (5) Failure that the state-of-the-art at the time of Azbil Corporation's shipment did not allow Azbil Corporation to predict; or
- (6) Failure that arose from any reason not attributable to Azbil Corporation, including, without limitation, acts of God, disasters, and actions taken by a third party.

Please note that the term "warranty" as used herein refers to equipment-only-warranty, and Azbil Corporation shall not be liable for any damages, including direct, indirect, special, incidental or consequential damages in connection with or arising out of Azbil Corporation's products.

2. Ascertainment of suitability

You are required to ascertain the suitability of Azbil Corporation's product in case of your use of the same with your machinery, equipment, etc. (hereinafter referred to as "Equipment") on your own responsibility, taking the following matters into consideration:

- (1) Regulations and standards or laws that your Equipment is to comply with.
- (2) Examples of application described in any documents provided by Azbil Corporation are for your reference purpose only, and you are required to check the functions and safety of your Equipment prior to your use.
- (3) Measures to be taken to secure the required level of the reliability and safety of your Equipment in your use

Although azbil is constantly making efforts to improve the quality and reliability of Azbil Corporation's products, there exists a possibility that parts and machinery may break down.

You are required to provide your Equipment with safety design such as fool-proof design, *1 and fail-safe design*2 (anti-flame propagation design, etc.), whereby preventing any occurrence of physical injuries, fires, significant damage, and so forth. Furthermore, fault avoidance,*3 fault tolerance,*4 or the like should be incorporated so that the said Equipment can satisfy the level of reliability and safety required for your use.

*1. A design that is safe even if the user makes an error.

*2. A design that is safe even if the device fails.

*3. Avoidance of device failure by using highly reliable components, etc.

*4. The use of redundancy.

3. Precautions and restrictions on application

Azbil Corporation's products other than those explicitly specified as applicable (e.g. azbil Limit Switch For Nuclear Energy) shall not be used in a nuclear energy controlled area (radiation controlled area).

Any Azbil Corporation's products shall not be used for/with medical equipment.

The products are for industrial use. Do not allow general consumers to install or use any Azbil Corporation's product.

However, azbil products can be incorporated into products used by general consumers. If you intend to use a product for that purpose, please contact one of our sales representatives.

In addition,

you are required to conduct a consultation with our sales representative and understand detail specifications, cautions for operation, and so forth by reference to catalogs, specifications, instruction manual, etc. in case that you intend to use azbil product for any purposes specified in (1) through (6) below.

Moreover, you are required to provide your Equipment with fool-proof design, fail-safe design, anti-flame propagation design, fault avoidance, fault tolerance, and other kinds of protection/safety circuit design on your own responsibility to ensure reliability and safety, whereby preventing problems caused by failure or nonconformity.

- (1) For use under such conditions or in such environments as not stated in technical documents, including catalogs, specification, and instruction manuals
- (2) For use of specific purposes, such as:
 - * Nuclear energy/radiation related facilities
[For use outside nuclear energy controlled areas] [For use of Azbil Corporation's Limit Switch For Nuclear Energy]
 - * Machinery or equipment for space/sea bottom
 - * Transportation equipment
[Railway, aircraft, vessels, vehicle equipment, etc.]
 - * Antidisaster/crime-prevention equipment

- * Burning appliances
 - * Electrothermal equipment
 - * Amusement facilities
 - * Facilities/applications associated directly with billing
- (3) Supply systems such as electricity/gas/water supply systems, large-scale communication systems, and traffic/air traffic control systems requiring high reliability
 - (4) Facilities that are to comply with regulations of governmental/public agencies or specific industries
 - (5) Machinery or equipment that may affect human lives, human bodies or properties
 - (6) Other machinery or equipment equivalent to those set forth in items (1) to (5) above which require high reliability and safety
4. Precautions against long-term use

Use of Azbil Corporation's products, including switches, which contain electronic components, over a prolonged period may degrade insulation or increase contact-resistance and may result in heat generation or any other similar problem causing such product or switch to develop safety hazards such as smoking, ignition, and electrification. Although acceleration of the above situation varies depending on the conditions or environment of use of the products, you are required not to use any Azbil Corporation's products for a period exceeding ten (10) years unless otherwise stated in specifications or instruction manuals.
 5. Recommendation for renewal

Mechanical components, such as relays and switches, used for Azbil Corporation's products will reach the end of their life due to wear by repetitious open/close operations. In addition, electronic components such as electrolytic capacitors will reach the end of their life due to aged deterioration based on the conditions or environment in which such electronic components are used. Although acceleration of the above situation varies depending on the conditions or environment of use, the number of open/close operations of relays, etc. as prescribed in specifications or instruction manuals, or depending on the design margin of your machine or equipment, you are required to renew any Azbil Corporation's products every 5 to 10 years unless otherwise specified in specifications or instruction manuals. System products, field instruments (sensors such as pressure/flow/level sensors, regulating valves, etc.) will reach the end of their life due to aged deterioration of parts. For those parts that will reach the end of their life due to aged deterioration, recommended replacement cycles are prescribed. You are required to replace parts based on such recommended replacement cycles.
 6. Other precautions

Prior to your use of Azbil Corporation's products, you are required to understand and comply with specifications (e.g., conditions and environment of use), precautions, warnings/cautions/notices as set forth in the technical documents prepared for individual Azbil Corporation's products, such as catalogs, specifications, and instruction manuals to ensure the quality, reliability, and safety of those products.
 7. Changes to specifications

Please note that the descriptions contained in any documents provided by azbil are subject to change without notice for improvement or for any other reason. For inquires or information on specifications as you may need to check, please contact our branch offices or sales offices, or your local sales agents.
 8. Discontinuance of the supply of products/parts

Please note that the production of any Azbil Corporation's product may be discontinued without notice. For repairable products, we will, in principle, undertake repairs for five (5) years after the discontinuance of those products. In some cases, however, we cannot undertake such repairs for reasons, such as the absence of repair parts. For system products, field instruments, we may not be able to undertake parts replacement for similar reasons.
 9. Scope of services

Prices of Azbil Corporation's products do not include any charges for services such as engineer dispatch service. Accordingly, a separate fee will be charged in any of the following cases:

 - (1) Installation, adjustment, guidance, and attendance at a test run
 - (2) Maintenance, inspection, adjustment, and repair
 - (3) Technical guidance and technical education
 - (4) Special test or special inspection of a product under the conditions specified by you

Please note that we cannot provide any services as set forth above in a nuclear energy controlled area (radiation controlled area) or at a place where the level of exposure to radiation is equivalent to that in a nuclear energy controlled area.

azbil

Azbil Corporation
Advanced Automation Company

1-12-2 Kawana, Fujisawa
Kanagawa 251-8522 Japan

URL: <http://www.azbil.com>

Specifications are subject to change without notice. (09)

1st edition: July 2003 (A)
9th edition: Jan. 2016 (F)