

**Operating Manual  
for  
1LX7\_\_\_-J\_\_\_  
with Increased-Safety Conduit  
and  
1LX7\_\_\_-R\_\_\_  
with Increased-Safety Packing  
Gas/ Vapour Explosion-Proof  
Limit Switches for Outdoor Applications,  
Compliant with IEC Explosion-Proof Standards  
(Ex d e IIC T6)**

**Thank you for purchasing this product.**

**Please be sure to read and understand this manual before use to ensure safety and effectiveness.**

**After installation, keep this manual for handy reference.**

**Azbil Corporation**

#### **NOTICE**

---

Be sure that the user receives this manual before the product is used.

Copying or duplicating this user's manual in part or in whole is forbidden. The information and specifications in this manual are subject to change without notice.

Considerable effort has been made to ensure that this manual is free from inaccuracies and omissions. If you should find an error or omission, please contact the azbil Group.

In no event is Azbil Corporation liable to anyone for any indirect, special or consequential damages as a result of using this product.

---

© 2012-2013 Azbil Corporation All Rights Reserved.

# Conventions Used in This Manual

---

- To prevent injury to the operator and others, and to prevent property damage, the following types of safety precautions are indicated:



Warnings are indicated when mishandling this product might result in death or serious injury.



Cautions are indicated when mishandling this product might result in minor injury to the user, or physical damage to the product.

- In describing the product, this manual uses the icons and conventions listed below.



Use caution when handling the product.



The indicated action is prohibited.



Be sure to follow the indicated instructions.

## **Handling Precautions:**

Handling Precautions indicate items that the user should pay attention to when handling the 1LX7.



## **Note:**

Notes indicate information that might benefit the user.



This indicates the item or page that the user is requested to refer to.

(1), (2), (3):

Numbers within parentheses indicate steps in a sequence or parts of an explanation.

# Safety Precautions

Safety precautions are intended to ensure the safe and correct use of this product, to prevent injury to the operator and others, and to prevent damage to property. Be sure to observe these safety precautions. Please make sure you understand the safety guidelines before reading the rest of this manual.

The use of this product in a manner not specified by the manufacturer will impair its built-in safety features.

## **WARNING**



This limit switch must be used within the specifications shown on page 1, which are specified for its certification for the Explosion-proof Construction of Electric Equipment and Devices. Otherwise, a serious accident could result.



To maintain explosion-proof performance, do not disassemble the limit switch, except for removing the cover when wiring, or changing the direction of the lever or head. Otherwise it will not satisfy explosion-proof specifications.

## **CAUTION**



The environmental conditions for the safe use of this limit switch in hazardous atmospheres are described in the product specification sheet. Use this limit switch within the allowable ranges for each characteristic as stated in the specifications.



Check the limit switch periodically to make sure that it is operating normally.



If the cover or exterior of the limit switch has some abnormality (dent, large crack or tiny cracks, etc.) replace the switch immediately. Failure to do so may result in an ineffective seal or loss of explosion-proof performance.



Wiring should comply with guidelines for explosion-proof electrical installations in general industrial use.

# Contents

---

## Conventions Used in This Manual Safety Precautions

<b>Chapter 1. Overview</b> .....	1
■ <b>Features</b> .....	1
⚠ <b>Applicable laws and standards</b> .....	1
<b>Chapter 2. Names of Parts</b> .....	2
■ <b>Appearance and structure of the limit switch</b> .....	2
■ <b>Composition of model numbers</b> .....	2
⚠ <b>Chapter 3. Installation and Adjustment</b> .....	3
■ <b>Installation</b> .....	4
■ <b>How to change the lever direction</b> .....	6
⚠ <b>How to change the head direction</b> .....	6
⚠ <b>Chapter 4. Wiring</b> .....	7
<b>Chapter 5. Adjustment</b> .....	10
■ <b>Points to check before beginning operation</b> .....	10
■ <b>Adjustment</b> .....	10
⚠ <b>Chapter 6. Maintenance and Inspection</b> .....	11
■ <b>Check points for maintenance</b> .....	12
<b>Chapter 7. Specifications</b> .....	13

⚠ This symbol indicates the presence of safety instructions.



# Chapter 1. Overview

## ■ Features

- Increased-safety explosion-proof limit switch incorporates an internal switch with a flameproof structure.
- Compliant with IEC explosion-proof standards (technical standard).
- Two-circuit double-break internal switch
- Can be used in hydrogen gas atmospheres.
- IP67 protective structure, suitable for outdoor use.

## ■ Applicable laws and standards

### **WARNING**



This limit switch must be used within the specifications shown below, which are specified for its certification for the Explosion-proof Construction of Electric Equipment and Devices. Otherwise, a serious accident could result.

1. This limit switch is explosion-protected electrical equipment certified by the Technology Institution of Industrial Safety (TIIS) in accordance with “Recommended Practice for Explosion-Protected Electrical installations in General Industries” (year 2008 guidelines, conforming to international standards).
2. Explosion-proof structure: d e  
(d: Flameproof type)  
(e: Increased-safety type)
3. Group and temperature class: IIC T6
4. Hazardous area classification: Gas atmospheres in Zone 1 and Zone 2 hazardous areas
5. Operating temperature: -10 to +60 °C
6. Operating humidity: 45 to 85 % RH
7. Storage temperature: -10 to +60 °C (standard type)  
-10 to +100 °C (H type)  
-40 to +60 °C (L type)  
-10 to +60 °C (if stored with the conduit section plug inserted)
8. Storage humidity: Max. 98 % RH (if stored with conduit section plug inserted)
9. Protective structure: IP54/IP67
10. Example of explosive gas group classification

Recommended Practice for Explosion-Protected Electrical Installations in General Industries (Explosion-proof, 1985)

Temperature class	T1	T2	T3	T4	T5	T6	
Explosive gas group classification	Over 450 °C	Over 301 °C to 450 °C incl.	Over 201 °C to 300 °C incl.	Over 136 °C to 200 °C incl.	Over 101 °C to 135 °C incl.	Over 86 °C to 100 °C incl.	
Group of explosion-proof electrical equipment	II	IIA	Acetone Ammonia Ethyl acetate Benzene Carbon monoxide Methane Methanol Propane Toluene	Ethanol Chloroethylene Butyl acetate Ethylbenzene Dimethylamine Propylene propan-1-ol Butane Methyl methacrylate	Octane Hexane Cyclohexane Butyl chloride Pentane 1-octanol Gasoline Kerosene Naphtha	Acetaldehyde Trimethylamine	Ethyl nitrite
		IIB	Acrylonitrile Hydrogen cyanide Cyclopropane Coke oven gas	Ethyl acrylate Ethylene Ethylene oxide 1,3-butadiene	Acrylic aldehyde Crotonaldehyde Dimethyl ether Tetrahydrofuran	Ethyl methyl ether Diethyl ether Dibutyl ether Tetrafluoroethylene	
	IIC	Hydrogen	Acetylene			Carbon disulfide	Nitric acid

Note. Switches classified as IIC T6 can be used in the gas or steam atmospheres listed inside the bold lines.

# Chapter 2. Names of Parts

## ■ Appearance and structure of the limit switch

External force applied to the limit switch is channeled successively to the lever, shaft, plunger, and internal switch, opening or closing the electric circuit. The lever on the limit switch rotates both to the left and to the right. The structure and names of parts are shown below.

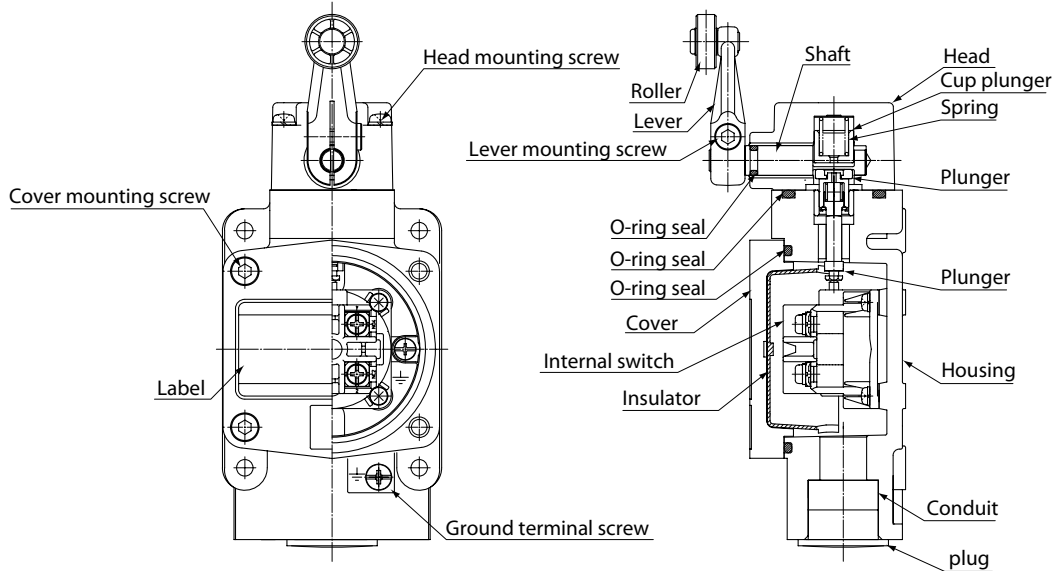

Example : 1LX7001-R

## ● 2PA-JEX \_\_\_ PM explosion-proof packing connector (for 1LX7 \_\_\_ -R \_\_\_ increased-safety packing type limit switch)

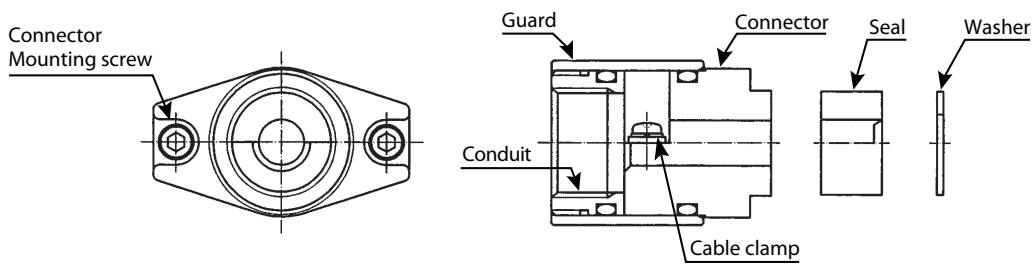

## ■ Composition of model numbers

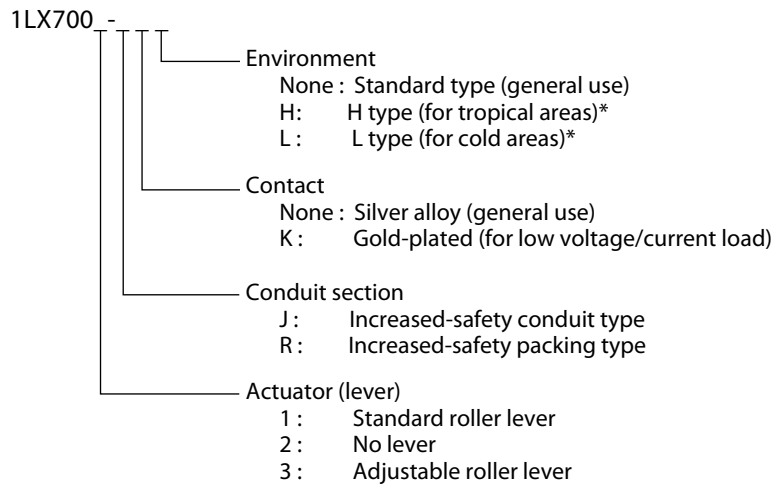

\*See page 1 for temperature and humidity.











# Chapter 3. Installation and Adjustment

This section describes how to install the limit switch.

## **WARNING**

-  Do not use the switch leaving the cover or conduit section open. Doing so may cause explosion resulting in a serious accident.

## **CAUTION**

-  Do not remove the cover or plug from the limit switch before wiring. If dust or liquid enters the switch, poor operation, poor electrical contact, or insulation failure may result.
-  After wiring is complete, do not leave the limit switch with its cover off. If dust or liquid enters the switch, poor operation, poor electrical contact, or insulation failure may result.
-  Before using for the first time, keep the whole limit switch protected with a dustproof, water-proof sheet to prevent cement and/or paint from adhering to the switch, as this may cause lever malfunction.
-  Do not leave the limit switch in an atmosphere containing gases (H<sub>2</sub>S, SO<sub>x</sub> etc.) that can adversely affect the contacts and/or other materials. Exposure to such gases can cause contact failure.
-  Do not allow the limit switch seals to come into contact with solvents (benzene, kerosene, alcohol, etc.) that may adversely affect them. Contact may lead to poor functioning or insulation failure.
-  Do not stand on the limit switch, place heavy objects on it, or strike it. Never apply a force 5 times greater than the operating force (O.F.) to the switch lever. Failure to observe these precautions may result in mechanical problems.
-  Before using a sealing agent, locking agent, etc. on the conduit joint, make sure that it will not generate fumes that will damage the contacts.
-  Make use of heat insulating material, a shielding plate, etc., in mounting the limit switch so that its temperature will not exceed the working temperature range as a result of radiant heat or heat conduction.
-  Take appropriate protective countermeasures if the limit switch is installed in a location subject to continuous vibration or impact.

## ■ Installation

### ● Installation

Make sure that the material, thickness, and shape of the surface on which the limit switch is mounted provide sufficient strength so that the operating force of the limit switch does not change the shape of the surface.

When installing the limit switch, use a washer or the like to prevent it from coming loose. See the table below for the tightening torque.

Mounting direction	Screw size	Tightening torque
Front mounting	M5 (hexagon socket head cap screw)	5 to 6 N·m
Back mounting	M6 (hexagon socket head cap screw)	5 to 6 N·m

### ● Attaching the lever

See the table below for the tightening torque of lever mounting screw.

Screw size	Tightening torque
M5 (hexagon socket head cap screw)	4 to 5.2 N·m

### ● Connecting 2PA-JEX\_\_\_ PM explosion-proof packing type connector (for 1LX7\_\_\_-R\_\_ increased-safety packing type limit switch)

Choose an explosion-proof packing connector from the 2PA-JEX series, making sure that is the correct size for the outer diameter of the cable.

See the table below for the tightening torque of connector mounting screws.

Screw size	Tightening torque
M5 (hexagon socket head cap screw)	5 to 6 N·m

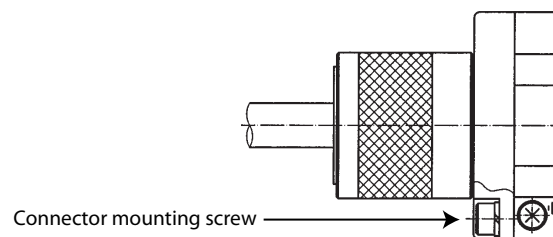

### ❗ Handling precautions

- If the explosion-proof packing connector is not the correct size for the outer diameter of the cable, explosion-proof performance cannot be maintained.
- Refer to the specifications sheet for details on the handling of explosion-proof packing connectors.

### ● Sealing fitting (for 1LX7\_\_\_-J\_\_ increased-safety conduit type limit switch)

Use the dedicated nipple and sealing fitting.

### ❗ Handling precautions

- See the AD specifications sheet, AD17024E.

● **Dog speed and angle**

- When the dog speed is less than 0.5 m/s (low speed)  
When the lever is vertical, select the dog angle ( $\alpha$ ) that corresponds to the dog's velocity from the table below.

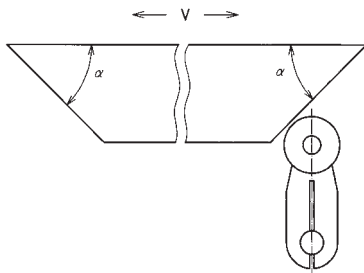

Dog angle at low speed

Dog angle ( $\alpha$ )	Maximum dog speed (V)
30°	0.40 m/s
45°	0.25 m/s
60°	0.10 m/s
75°	0.07 m/s
90°	0.05 m/s

- If  $0.5 \text{ m/s} \leq V \leq 2 \text{ m/s}$  (high speed)  
Select the dog angle ( $\alpha$ ) and the set angle for the lever ( $\theta$ ) from the table below, according to the velocity (V) of the dog.

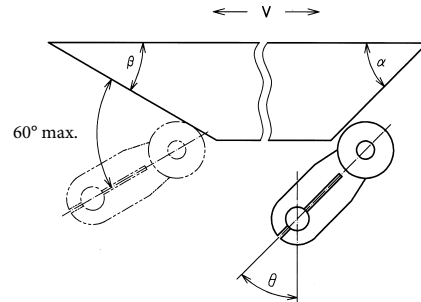

A double action of the lever can be prevented if the dog angle ( $\beta$ ) at the back end is maintained at 15 to 30°.

Dog angle and set angle at high speed

Dog angle ( $\alpha$ )	Set angle ( $\theta$ )	Maximum dog velocity (V)
45°	45°	0.50 m/s
40°	50°	0.60 m/s
30 to 35°	55 to 60°	1.30 m/s
15 to 25°	65 to 75°	2.00 m/s

The allowable operating speed of the product is specified in the specifications sheet.

● **About the dog**

The roughness or hardness of the dog's surface significantly affects the operating life of the switch. The following specifications are recommended.

Surface roughness	Vickers hardness
About Ra 6.3	About Hv 450

❗ **Handling precautions**

- If grease is applied to the sliding parts of the roller, dog, etc., they will move more smoothly.

❗ **Handling precautions**

- The dog should not touch any object other than the roller.

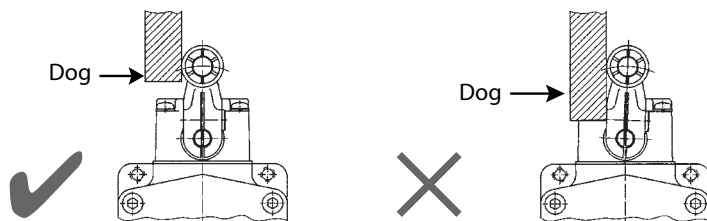

The dog touches not only the roller but also other parts.

- The full width of the roller should make contact with the dog.

● **Overtravel and force**

To ensure reliable operation, set overtravel (O.T.) between 1/3 to 2/3 of the specified value.

❗ **Handling precautions**

- Do not apply excessive force (5 times the O.F. or more) to the lever beyond the operating limit position. Doing so may cause malfunction.

■ **How to change the lever direction**

● **Procedure**

- (1) Loosen the lever mounting screw.
- (2) Reverse the lever and fit it into position firmly.
- (3) Tighten the lever mounting screw according to the table below.

Screw size	Tightening torque
M5 (hexagon socket head cap screw)	4 to 5.2 N·m

❗ **Handling precautions**

- Do not tighten beyond the specified torques. Overtightening may damage screw threads.

■ **How to change the head direction**

● **Procedure**

- (1) Remove the four head mounting screws.

❗ **Handling precautions**

- The O-ring attached to this unit may come off when the head assembly is removed.  
Be sure to put it back in its original position, or sealing performance will be lost.

- (2) Change the head direction.  
When viewing the front of the cover, the head direction can be changed 90° to the left or right, or 180°.
- (3) Tighten the head mounting screws according to the table below.

Screw size	Tightening torque
M4 (pan-head screw with spring washer)	1.3 to 1.7 N·m

# Chapter 4. Wiring

## ⚠ WARNING



Before wiring, turn the equipment power off.  
Depending on the supply voltage, failure to do so may result in an electric shock.

## ⚠ CAUTION



Wiring should comply with guidelines for explosion-proof electrical installations in general industrial use.



Securely attach the cover so that it tightly contacts the housing.  
If the cover is not well tightened the limit switch will not be effectively sealed.



Be sure to ground the limit switch, using either the internal ground screw or an external one.



Do not use silicone rubber wire, silicone adhesive, or grease that contains silicone.  
They can cause contact failure of electrical contacts.



For connection to a wiring conduit with G1/2 pipe thread, screw in to a depth of at least 5 threads and secure with a lock nut. If waterproofing is required, apply sealant to the screw threads. For explosion-proofing, be sure to use a sealing fitting to connect the conduit to the switch, and apply sealing compound.

For waterproof applications, use liquid gasket or other sealant on the conduit threads.



Use wires or cables that can withstand at least 70 °C.

### ⚠ Handling precautions

- Be sure to select wire or cable that is appropriate for the application environment.
- When wiring the terminal block, use wires or cables whose nominal cross-sectional area is 0.5–1.5 mm<sup>2</sup> (20–16 AWG) with M4 crimp terminals having insulating sleeves (made by J.S.T. Mfg. Co., Ltd., or equivalent).
- See the figure below for the size of the ring crimp terminal.

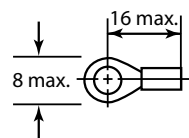
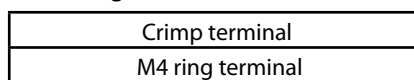

- Make sure that wires and crimp terminals with insulating sleeves do not touch the cover.
- Be sure to bend the insulated crimp terminals down. Otherwise, the cover will not close properly.
- Make sure that electric wires do not touch the plunger. If they do, poor performance could result.
- When installing flexible piping, make sure that the electric wires inside do not twist.

● **Removing the cover**

Remove the hexagon socket head cap screws ( M5 ) with a hexagon wrench ( 4 mm ).

● **Wiring the limit switch**

**⚠ CAUTION**

⚠ To wire the limit switch correctly, refer to the user's manual or to the specifications sheet.

- See the table below for the tightening torque of terminal screws.

Screw size	Tightening torque
M4 (pan-head screw with square washer)	1.3 to 1.7 N·m

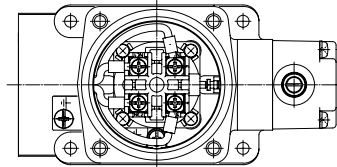

Typical wire routing

- **Terminal tensile strength**  
After wiring do not pull the wire or cable in the direction of the conduit with a force (in N) that is more than 10 times the cable diameter (in mm).  
For other directions, do not pull with a force of 98 N or more.

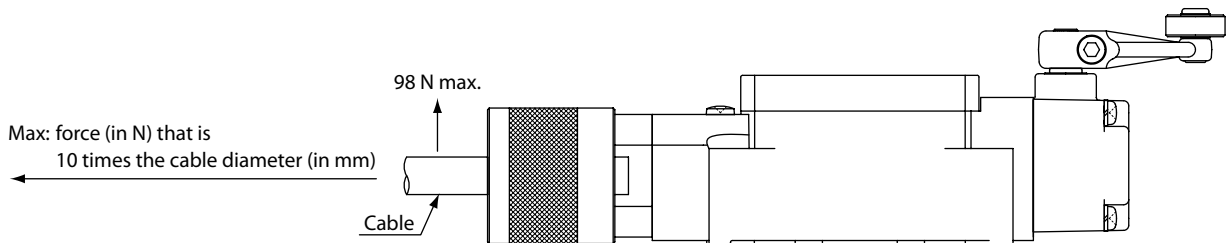

**⚠ Handling precautions**

- Do not exceed the values given for pulling force, which is the same for both single wire and two or more stranded wires.

### ● Attaching the cover

After wiring, attach the cover.

Tighten the four cover mounting screws evenly and diagonally.

See the table below for the tightening torque.

Screw size	Tightening torque
M5 (hexagon socket head cap screw)	5 to 6 N·m

### ! Handling precautions

- When attaching the cover, make sure that it does not touch wires or terminals and does not pinch the wiring insulation.
- Do not tighten beyond the specified torques. Overtightening may strip screw threads of the housing.

### ● Continuity tester

For a continuity check for the limit switch, use a tester whose measuring current is 100 mA or less.

### ● Connecting an explosion-proof packing type connector (for 1LX7 \_\_\_-R\_\_ increased-safety packing type limit switch)

For details on explosion-proof packing connector, see the specifications sheet.

### ● Mounting a sealing fitting (for 1LX7 \_\_\_-J\_\_ increased-safety conduit type limit switch)

For details on the dedicated nipple and sealing fitting, see the AD specifications sheet, AD17024E.

# Chapter 5. Adjustment

## ■ Points to check before beginning operation

Check the following before using the limit switch.

- (1) Wiring is correct.
- (2) The limit switch mounting screws, lever mounting screws, and cover mounting screws are not loose.
- (3) The conduit joint is well sealed using a sealed connector or flexible piping.

## ■ Adjustment

- (1) To adjust the limit switch's operating position, adjust the dog position or the mounting position of the limit switch.
- (2) To ensure reliable operation, set overtravel (O.T.) between 1/3 to 2/3 of the specified value.

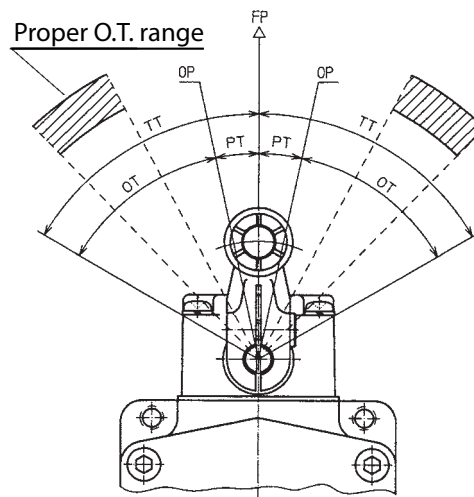

## ❗ Handling precautions

- Do not apply excessive force (5 times the O.F. or more) to the lever beyond the operating limit position. Doing so may cause malfunction.
- Do not attempt to move the lever beyond the operating limit.
- Adjustment is also possible by changing the mounting position of the lever. However this method cannot be used repeatedly because the knurled pattern of the shaft bites into the lever.



# Chapter 6. Maintenance and Inspection

## **WARNING**



This limit switch must be used within the specifications shown on page 1, which are specified for its certification for the Explosion-proof Construction of Electric Equipment and Devices. Otherwise, a serious accident could result.

## **CAUTION**



After inspecting the limit switch, firmly tighten the cover and conduit. Insufficient tightening because of corrosion, etc., not only results in the loss of sealing and insulating performance, but also compromises the switch's explosion-proofing.



Except for the lever, the parts of this limit switch cannot be replaced.



To ensure safe use the limit switch must be inspected periodically. Adjust the frequency of inspection depending on the service conditions.

### ■ Check points for maintenance

The table below shows check points for maintenance of the limit switch. Generally the service life of the limit switch is five years. However the service life varies depending on the application environment.

#### ● Tools for inspection

- Screwdriver
- Tester
- Insulation resistance tester
- Hexagon wrench

No.	Check item	Check points	How to check	Countermeasures	Frequency
1.	Roller lever	<ul style="list-style-type: none"> <li>• Operating position</li> <li>• Slippage of position</li> <li>• Loose mounting screws</li> <li>• Roller rotation</li> </ul>	<ul style="list-style-type: none"> <li>• Check for loose lever mounting screws, poor roller rotation, and damage.</li> </ul>	<ul style="list-style-type: none"> <li>• If mounting screws are loose, tighten them. (Tightening torques are shown in chapter 3.)</li> <li>• In other cases, replace the limit switch.</li> </ul>	Every inspection for loose screws and every 6 months for others
2	Head	<ul style="list-style-type: none"> <li>• Loose head mounting screws</li> <li>• External damage</li> </ul>	<ul style="list-style-type: none"> <li>• Visually check for loose head mounting screws.</li> <li>• Check for external damage to the head.</li> </ul>	<ul style="list-style-type: none"> <li>• If mounting screws are loose, tighten them. (Tightening torques are shown in chapter 3.)</li> <li>• In other cases, replace the limit switch.</li> </ul>	Every inspection or every 6 months
3	Cover	<ul style="list-style-type: none"> <li>• Loose cover mounting screws</li> <li>• External damage</li> </ul>	<ul style="list-style-type: none"> <li>• Visually check for loose cover mounting screws.</li> <li>• Check for external damage to the cover.</li> </ul>	<ul style="list-style-type: none"> <li>• If mounting screws are loose, tighten them. (Tightening torques are shown in chapter 4.)</li> <li>• In other cases, replace the limit switch.</li> </ul>	Every inspection for loose screw and every 6 months for othes
4	Housing	<ul style="list-style-type: none"> <li>• External damage</li> </ul>	<ul style="list-style-type: none"> <li>• Visually check for external damage.</li> </ul>	<ul style="list-style-type: none"> <li>• Replace the limit switch.</li> </ul>	Every 2 years
5	Terminal box (internal switch)	<ul style="list-style-type: none"> <li>• Electrical continuity</li> </ul>	<ul style="list-style-type: none"> <li>• Check all terminals with a continuity tester.</li> </ul>	<ul style="list-style-type: none"> <li>• Replace the limit switch.</li> </ul>	Every inspection or every 6 months
		<ul style="list-style-type: none"> <li>• Insulation</li> </ul>	<ul style="list-style-type: none"> <li>• Check all terminals with an insulation resistance tester.</li> </ul>	<ul style="list-style-type: none"> <li>• Replace the limit switch.</li> </ul>	Every inspection or every 6 months
		<ul style="list-style-type: none"> <li>• Loose screws</li> <li>• Corrosion</li> </ul>	<ul style="list-style-type: none"> <li>• Check for loose terminal screws, damage, rust, etc.</li> </ul>	<ul style="list-style-type: none"> <li>• If mounting screws are loose, tighten them. (Tightening torques are shown in chapter 4.)</li> </ul>	Every inspection or every 6 months
6	Operation	<ul style="list-style-type: none"> <li>• Operation check</li> </ul>	<ul style="list-style-type: none"> <li>• Check the overtravel.</li> </ul>	<ul style="list-style-type: none"> <li>• Readjust the overtravel.</li> </ul>	Every inspection or every 6 months
			<ul style="list-style-type: none"> <li>• Check that the roller lever moves smoothly by moving it by hand.</li> </ul>	<ul style="list-style-type: none"> <li>• Replace the limit switch.</li> </ul>	Every inspection or every 6 months
7	Explosion-proof packing type connector	<ul style="list-style-type: none"> <li>• Loose connector</li> </ul>	<ul style="list-style-type: none"> <li>• Check for loose connector.</li> </ul>	<ul style="list-style-type: none"> <li>• Tighten the connector.</li> </ul>	Every inspection or every 6 months
		<ul style="list-style-type: none"> <li>• Loose cables</li> </ul>	<ul style="list-style-type: none"> <li>• Check for loose cables.</li> </ul>	<ul style="list-style-type: none"> <li>• Tighten the connector.</li> </ul>	Every inspection or every 6 months
8	Nipple and sealing fitting	<ul style="list-style-type: none"> <li>• Loose nipple and loose sealing fitting</li> </ul>	<ul style="list-style-type: none"> <li>• Check for loose nipple and loose sealing fitting.</li> </ul>	<ul style="list-style-type: none"> <li>• Tighten the nipple and/or the sealing fitting.</li> </ul>	Every inspection or every 6 months

Note. Except for the lever, the parts of this limit switch cannot be replaced. Replace the entire switch.

# Chapter 7. Specifications

---

For the detailed specifications for the limit switch, see the specifications sheet.

The relevant specifications sheet numbers are shown below. To acquire them, please contact the azbil Group or a sales representative.

Model No.	Spec. No.
1LX700_ _ _ _	AD15804E
2PA-JEX_ _ _ PM	AD17216E
2PA-JEXN_ _	AD17024E

**-Memo-**

---

# Revision History of CP-SP-1318E

Printed	Edn.	Revised pages	Description
June 2012	1		
July 2013	2		Overall revision. 2nd ed = 3th Jp ed.

# Terms and Conditions

We would like to express our appreciation for your purchase and use of Azbil Corporation's products. You are required to acknowledge and agree upon the following terms and conditions for your purchase of Azbil Corporation's products (system products, field instruments, control valves, and control products), unless otherwise stated in any separate document, including, without limitation, estimation sheets, written agreements, catalogs, specifications and instruction manuals.

## 1. Warranty period and warranty scope

### 1.1 Warranty period

Azbil Corporation's products shall be warranted for one (1) year from the date of your purchase of the said products or the delivery of the said products to a place designated by you.

In the case of products that Azbil Corporation has repaired for a fee, the repaired part only shall be warranted for three (3) months from the time of delivery to the location designated by the customer.

### 1.2 Warranty scope

In the event that Azbil Corporation's product has any failure attributable to azbil during the aforementioned warranty period, Azbil Corporation shall, without charge, deliver a replacement for the said product to the place where you purchased, or repair the said product and deliver it to the aforementioned place.

Notwithstanding the foregoing, any failure falling under one of the following shall not be covered under this warranty:

- (1) Failure caused by your improper use of azbil product (noncompliance with conditions, environment of use, precautions, etc. set forth in catalogs, specifications, instruction manuals, etc.);
- (2) Failure caused for other reasons than Azbil Corporation's product;
- (3) Failure caused by any modification or repair made by any person other than Azbil Corporation or Azbil Corporation's subcontractors;
- (4) Failure caused by your use of Azbil Corporation's product in a manner not conforming to the intended usage of that product;
- (5) Failure that the state-of-the-art at the time of Azbil Corporation's shipment did not allow Azbil Corporation to predict; or
- (6) Failure that arose from any reason not attributable to Azbil Corporation, including, without limitation, acts of God, disasters, and actions taken by a third party.

Please note that the term "warranty" as used herein refers to equipment-only-warranty, and Azbil Corporation shall not be liable for any damages, including direct, indirect, special, incidental or consequential damages in connection with or arising out of Azbil Corporation's products.

## 2. Ascertainment of suitability

You are required to ascertain the suitability of Azbil Corporation's product in case of your use of the same with your machinery, equipment, etc. (hereinafter referred to as "Equipment") on your own responsibility, taking the following matters into consideration:

- (1) Regulations and standards or laws that your Equipment is to comply with.
- (2) Examples of application described in any documents provided by Azbil Corporation are for your reference purpose only, and you are required to check the functions and safety of your Equipment prior to your use.
- (3) Measures to be taken to secure the required level of the reliability and safety of your Equipment in your use

Although azbil is constantly making efforts to improve the quality and reliability of Azbil Corporation's products, there exists a possibility that parts and machinery may break down.

You are required to provide your Equipment with safety design such as fool-proof design,\*1 and fail-safe design\*2 (anti-flame propagation design, etc.), whereby preventing any occurrence of physical injuries, fires, significant damage, and so forth. Furthermore, fault avoidance,\*3 fault tolerance,\*4 or the like should be incorporated so that the said Equipment can satisfy the level of reliability and safety required for your use.

\*1. A design that is safe even if the user makes an error.

\*2. A design that is safe even if the device fails.

\*3. Avoidance of device failure by using highly reliable components, etc.

\*4. The use of redundancy.

## 3. Precautions and restrictions on application

Azbil Corporation's products other than those explicitly specified as applicable (e.g. azbil Limit Switch For Nuclear Energy) shall not be used in a nuclear energy controlled area (radiation controlled area).

Any Azbil Corporation's products shall not be used for/with medical equipment.

The products are for industrial use. Do not allow general consumers to install or use any Azbil Corporation's product.

However, azbil products can be incorporated into products used by general consumers. If you intend to use a product for that purpose, please contact one of our sales representatives.

In addition,

you are required to conduct a consultation with our sales representative and understand detail specifications, cautions for operation, and so forth by reference to catalogs, specifications, instruction manual, etc. in case that you intend to use azbil product for any purposes specified in (1) through (6) below.

Moreover, you are required to provide your Equipment with fool-proof design, fail-safe design, anti-flame propagation design, fault avoidance, fault tolerance, and other kinds of protection/safety circuit design on your own responsibility to ensure reliability and safety, whereby preventing problems caused by failure or nonconformity.

- (1) For use under such conditions or in such environments as not stated in technical documents, including catalogs, specification, and instruction manuals
- (2) For use of specific purposes, such as:
  - \* Nuclear energy/radiation related facilities  
[For use outside nuclear energy controlled areas] [For use of Azbil Corporation's Limit Switch For Nuclear Energy]
  - \* Machinery or equipment for space/sea bottom

- \* Transportation equipment  
[Railway, aircraft, vessels, vehicle equipment, etc.]
  - \* Antidisaster/crime-prevention equipment
  - \* Burning appliances
  - \* Electrothermal equipment
  - \* Amusement facilities
  - \* Facilities/applications associated directly with billing
- (3) Supply systems such as electricity/gas/water supply systems, large-scale communication systems, and traffic/air traffic control systems requiring high reliability
  - (4) Facilities that are to comply with regulations of governmental/public agencies or specific industries
  - (5) Machinery or equipment that may affect human lives, human bodies or properties
  - (6) Other machinery or equipment equivalent to those set forth in items (1) to (5) above which require high reliability and safety
4. Precautions against long-term use
 

Use of Azbil Corporation's products, including switches, which contain electronic components, over a prolonged period may degrade insulation or increase contact-resistance and may result in heat generation or any other similar problem causing such product or switch to develop safety hazards such as smoking, ignition, and electrification. Although acceleration of the above situation varies depending on the conditions or environment of use of the products, you are required not to use any Azbil Corporation's products for a period exceeding ten (10) years unless otherwise stated in specifications or instruction manuals.
  5. Recommendation for renewal
 

Mechanical components, such as relays and switches, used for Azbil Corporation's products will reach the end of their life due to wear by repetitious open/close operations. In addition, electronic components such as electrolytic capacitors will reach the end of their life due to aged deterioration based on the conditions or environment in which such electronic components are used. Although acceleration of the above situation varies depending on the conditions or environment of use, the number of open/close operations of relays, etc. as prescribed in specifications or instruction manuals, or depending on the design margin of your machine or equipment, you are required to renew any Azbil Corporation's products every 5 to 10 years unless otherwise specified in specifications or instruction manuals. System products, field instruments (sensors such as pressure/flow/level sensors, regulating valves, etc.) will reach the end of their life due to aged deterioration of parts. For those parts that will reach the end of their life due to aged deterioration, recommended replacement cycles are prescribed. You are required to replace parts based on such recommended replacement cycles.
  6. Other precautions
 

Prior to your use of Azbil Corporation's products, you are required to understand and comply with specifications (e.g., conditions and environment of use), precautions, warnings/cautions/notices as set forth in the technical documents prepared for individual Azbil Corporation's products, such as catalogs, specifications, and instruction manuals to ensure the quality, reliability, and safety of those products.
  7. Changes to specifications
 

Please note that the descriptions contained in any documents provided by azbil are subject to change without notice for improvement or for any other reason. For inquires or information on specifications as you may need to check, please contact our branch offices or sales offices, or your local sales agents.
  8. Discontinuance of the supply of products/parts
 

Please note that the production of any Azbil Corporation's product may be discontinued without notice. For repairable products, we will, in principle, undertake repairs for five (5) years after the discontinuance of those products. In some cases, however, we cannot undertake such repairs for reasons, such as the absence of repair parts. For system products, field instruments, we may not be able to undertake parts replacement for similar reasons.
  9. Scope of services
 

Prices of Azbil Corporation's products do not include any charges for services such as engineer dispatch service. Accordingly, a separate fee will be charged in any of the following cases:

    - (1) Installation, adjustment, guidance, and attendance at a test run
    - (2) Maintenance, inspection, adjustment, and repair
    - (3) Technical guidance and technical education
    - (4) Special test or special inspection of a product under the conditions specified by you

Please note that we cannot provide any services as set forth above in a nuclear energy controlled area (radiation controlled area) or at a place where the level of exposure to radiation is equivalent to that in a nuclear energy controlled area.



---

**Azbil Corporation**  
Advanced Automation Company

1-12-2 Kawana, Fujisawa  
Kanagawa 251-8522 Japan

URL: <http://www.azbil.com>

*Specifications are subject to change without notice.* (09)

1st edition: June 2012 (V)  
2nd edition: July 2013 (F)