

AT9000 Advanced Transmitter

Remote-sealed type of Differential Pressure Transmitters

OVERVIEW

AT9000 Advanced Transmitter is a microprocessor-based smart transmitter that features high performance and excellent stability. Capable of measuring gas, liquid, and vapor, and liquid levels, it transmits 4 to 20 mA DC analog and digital signals according to the measured differential pressure.

It can also execute two-way communications between the communicator, thus facilitating self-diagnosis, range resetting, and automatic zero/span adjustment.

SFN, HART® and FOUNDATION Fieldbus are available.

* Refer to SS2-GTX00Z-0100 for FOUNDATION Fieldbus type for the items marked with [★].



FEATURES

Excellent stability and high performance

- Long-term stability is proven in 500,000 installations worldwide.
- Unique characterization and composite semiconductor sensors realize excellent temperature and static pressure characteristics.

A diverse lineup

- A diverse flange lineup, ranging from 1/2 inch (15 mm) to 4 inches (100mm), is available to meet user requirements.
- A wide range of models, including those for general purposes, high-temperature, and high temperature and high-vacuum service, is available to meet user requirements. In addition, the working temperature range of regular type has been expanded to 180 °C maximum to allow you greater freedom instrumentation.
- A wide variety of corrosion-resistant materials for wetted parts is also available.

Function to correct the temperature of the fill fluid of the capillary section

Changes in the density of the fill fluid caused by temperature fluctuations are calculated, and the output is corrected accordingly. This function substantially reduces (to 1/5 - 1/10) the effect of seasonal fluctuations in temperature.

Remote communication

- Two-way communication using digital output facilitates self-diagnosis, range resetting, automatic zero adjustment, and other operations.

China RoHS

This device is used in the Oil & Gas, Petrochemical, Chemical, Pulp & Paper, Food & Beverage, Machinery, Steel/Metal & Mining, and Automobile industries and therefore does not fall under the China RoHS Legislation.

If this device is used in semiconductor manufacturing equipment, labeling on the device and documents for the China RoHS may be required. If such documents are required, consult an Azbil Corp. representative.

HART® is a registered trademark of the FieldComm Group.

FOUNDATION™ is a trademark of the FieldComm Group.

PRODUCT APPROVALS [☆]**FM Explosionproof for Division System/
Flameproof for Zone System (Code F1)**

Explosionproof for Class I, Division 1, Groups A, B, C and D; Class I, Zone 1, AEx d IIC

Dust-Ignitionproof for Class II, III, Division 1, Groups E, F and G

T5 $-40\text{ °C} \leq T_{amb} \leq +85\text{ °C}$

Hazardous locations

Indoor/Outdoor Type 4X, IP67

Factory sealed, conduit seal not required for Division applications

Caution - Use supply wires suitable for 5 °C above surrounding ambient

FM Intrinsic Safety (Code F2)

IS/I, II, III/1/ABCDEFGH/T4; $-40\text{ °C} \leq T_{amb} \leq +60\text{ °C}$;
80395278, 80395279, 80395280; Entity; TYPE 4X; IP67

I/0/AEx ia/IIC/T4; $-40\text{ °C} \leq T_{amb} \leq +60\text{ °C}$; 80395278,
80395279, 80395280; Entity; TYPE 4X; IP67

Entity Parameters: V_{max} (U_i)=30 Volts, I_{max} (I_i)=100 mA,
 P_i =1 W, C_i =10 nF, L_i =0.5 mH

FM Nonincendive (Code F5)

NI/I/2/ABCD/T4; $-40\text{ °C} \leq T_{amb} \leq +60\text{ °C}$; 80395494; NIFW;
TYPE 4X; IP67

NI/I/2/IIC/T4; $-40\text{ °C} \leq T_{amb} \leq +60\text{ °C}$; 80395494; NIFW;
TYPE 4X; IP67

S/II, III/1/EFG/T4; $-40\text{ °C} \leq T_{amb} \leq +60\text{ °C}$;
80395494; NIFW; TYPE 4X; P67

Nonincendive Field Wiring Parameters:

V_{max} (U_i)=30 Volts, C_i =10 nF, L_i =0.5 mH

Combination of F1, F2 and F5 (Code F6)**ATEX Flameproof (Code A1)**

 0344

 KEMA 08ATEX0004

II 1/2 G Ex d IIC T6 $T_{process}=85\text{ °C}$
 $-30\text{ °C} \leq T_{amb} \leq +75\text{ °C}$ IP66/67

II 1/2 G Ex d IIC T5 $T_{process}=100\text{ °C}$
 $-30\text{ °C} \leq T_{amb} \leq +80\text{ °C}$ IP66/67

II 1/2 G Ex d IIC T4 $T_{process}=110\text{ °C}$
 $-30\text{ °C} \leq T_{amb} \leq +80\text{ °C}$ IP66/67

II 2 D Ex tD A21 IP66/67 T85 $T_{process}=85\text{ °C}$
 $-30\text{ °C} \leq T_{amb} \leq +75\text{ °C}$

II 2 D Ex tD A21 IP66/67 T100 $T_{process}=100\text{ °C}$
 $-30\text{ °C} \leq T_{amb} \leq +75\text{ °C}$

II 2 D Ex tD A21 IP66/67 T110 $T_{process}=110\text{ °C}$
 $-30\text{ °C} \leq T_{amb} \leq +75\text{ °C}$

Caution - Use supply wires suitable for 5 °C above surrounding ambient

ATEX Intrinsic Safety (Code A2)

 0344

 KEMA 07ATEX0200 X

II 1 G Ex ia IIC T4 $T_{process}=105\text{ °C}$
 $-30\text{ °C} \leq T_{amb} \leq +60\text{ °C}$ IP66/67

Electrical Parameters: U_i =30 V, I_i =93 mA, P_i =1 W, C_i =5 nF,
 L_i =0.5 mH

II 1 D Ex iaD 20 IP66/67 T105 $T_{process}=105\text{ °C}$
 $-30\text{ °C} \leq T_{amb} \leq +60\text{ °C}$

NEPSI Flameproof (Code N1)

Ex d IIC T6 DIP A21 T_A 85 °C $T_{process}=80\text{ °C}$
 $-30\text{ °C} \leq T_{amb} \leq +75\text{ °C}$

Ex d IIC T5 DIP A21 T_A 100 °C $T_{process}=95\text{ °C}$
 $-30\text{ °C} \leq T_{amb} \leq +80\text{ °C}$

Ex d IIC T4 DIP A21 T_A 115 °C $T_{process}=110\text{ °C}$
 $-30\text{ °C} \leq T_{amb} \leq +80\text{ °C}$

ENCLOSURE TYPE IP66/67

NEPSI Intrinsic Safety (Code N2)

Ex ia IIC T4 $T_{process}=105\text{ °C}$
 $-30\text{ °C} \leq T_{amb} \leq +60\text{ °C}$

Enclosure IP66/67

Electrical Parameters: U_i =30 V, I_i =100 mA, P_i =1 W,
 C_i =13 nF, L_i =0.5 mH

NEPSI Type n (Code N5)

Ex nL IIC T4 $T_{process}=110\text{ °C}$
 $-30\text{ °C} \leq T_{amb} \leq +60\text{ °C}$

Enclosure IP66/67

Electrical Parameters: U_i =30 V, I_i =100 mA, P_i =1 W,
 C_i =13 nF, L_i =0.5 mH

IECEX Flameproof (Code E1)

Certificate No. IECEX KEM 08.0001
Ga/Gb Ex d IIC T6 $T_{process}=85\text{ °C}$
 $-30\text{ °C} \leq T_{amb} \leq +75\text{ °C}$ IP66/67

Ga/Gb Ex d IIC T5 $T_{process}=100\text{ °C}$
 $-30\text{ °C} \leq T_{amb} \leq +80\text{ °C}$ IP66/67

Ga/Gb Ex d IIC T4 $T_{process}=110\text{ °C}$
 $-30\text{ °C} \leq T_{amb} \leq +80\text{ °C}$ IP66/67

Ex tD A21 IP66/67 T85 $T_{process}=85\text{ °C}$
 $-30\text{ °C} \leq T_{amb} \leq +75\text{ °C}$

Ex tD A21 IP66/67 T100 $T_{process}=100\text{ °C}$
 $-30\text{ °C} \leq T_{amb} \leq +75\text{ °C}$

Ex tD A21 IP66/67 T110 $T_{process}=110\text{ °C}$
 $-30\text{ °C} \leq T_{amb} \leq +75\text{ °C}$

Caution - Use supply wires suitable for 5 °C above surrounding ambient

IECEX Intrinsic Safety (Code E2)

IECEX KEM 07.0058X

Zone 0 Ex ia IIC T4 $T_{process}=105\text{ °C}$
 $-30\text{ °C} \leq T_{amb} \leq +60\text{ °C}$ IP66/67

Electrical Parameters: U_i =30 V, I_i =93 mA, P_i =1 W, C_i =5 nF,
 L_i =0.5 mH

Ex iaD 20 IP66/67 T105 $T_{process}=105\text{ °C}$
 $-30\text{ °C} \leq T_{amb} \leq +60\text{ °C}$

IKOSHA Flameproof (Code K1)

Ex d II C T6 T_{process}=85 °C

-30 °C ≤ T_{amb} ≤ +75 °C

Ex d II C T5 T_{process}=100 °C

-30 °C ≤ T_{amb} ≤ +80 °C

Ex d II C T4 T_{process}=110 °C

-30 °C ≤ T_{amb} ≤ +80 °C

EMC Conformity [★]

EN 61326-1 (industrial electromagnetic environment)

EN 61326-2-3

FUNCTIONAL SPECIFICATIONS

Type of protection

NEMA 3 and 4X

IEC IP66/67

Measuring span/Setting range/Working pressure range

	Measuring Span	Setting Range	Working Pressure Range
GTX 35R	2.5 to 100 kPa {250 to 10160 mmH ₂ O}	-100 to +100 kPa {-10160 to +10160 mmH ₂ O}	Up to flange rating*
GTX 40R	35 to 700 kPa {0.35 to 7 kgf/cm ² }	-100 to +700 kPa {-1 to +7 kgf/cm ² }	

Note) For negative pressures, see Figure 1, Figure 2 and Figure 3.

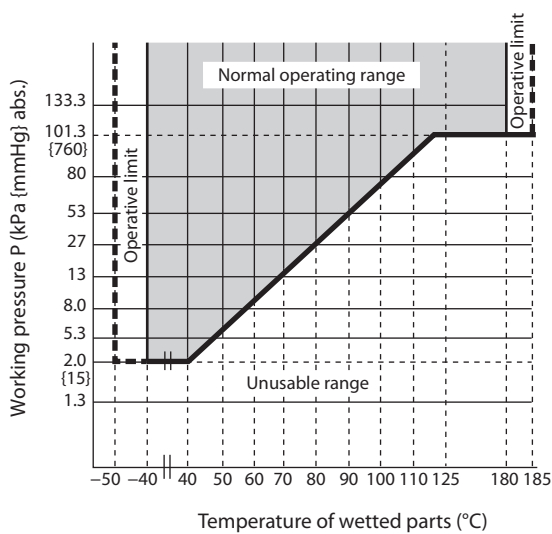

Figure 1. Working pressure and temperature of wetted parts section (for general purpose models)

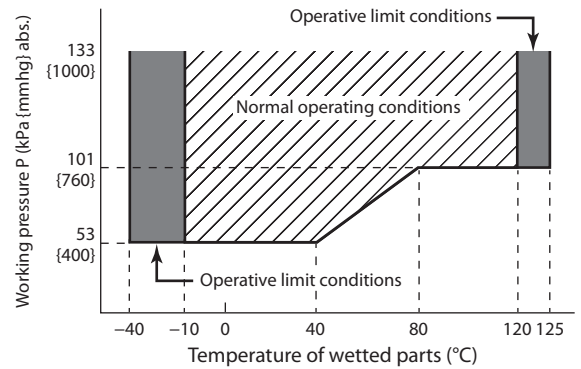
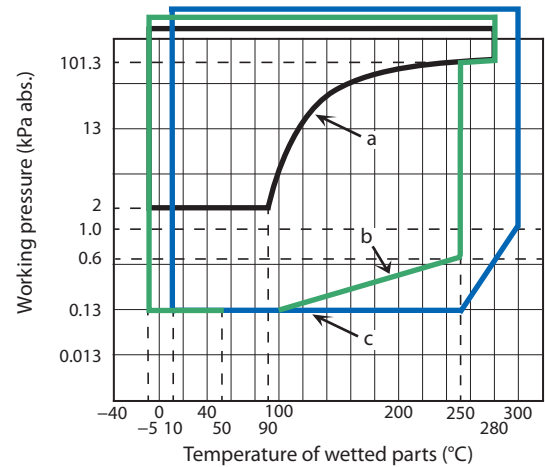

Figure 2. Working pressure and temperature wetted parts section (for oxygen and chlorine service)



a. For high temperature b. For high temperature and vacuum, c. For high temperature and high vacuum

Figure 3. Working pressure temperature of wetted parts section (For high temperature/high temperature and vacuum/high temperature and high vacuum)

Power Supply [★]

12.5 to 42 V DC

Limited to 12.5 to 30 V DC for intrinsic safety, Type n, Non-incendive types

Power Supply voltage and load resistance characteristics [★]

See Figure 4.

Limited to Load resistance: 250 to 1345 Ω for SFN or DE communication. 250 to 600 Ω for HART communication. Power supply voltage: 12.5 to 30 V DC for intrinsic safety, Type n, Nonincendive types

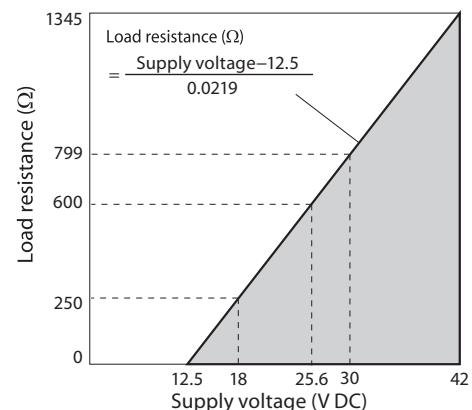

Figure 4. Supply voltage vs. load resistance characteristics

Note) For communication with a communicator, a load resistance of 250 Ω or more is necessary.

Output [☆]

Analog output (4 to 20 mA DC) with DE protocol
 Analog output (4 to 20 mA DC) with HART protocol
 Digital output (DE protocol)

Output signal [☆]

3.6 to 21.6 mA
 3.8 to 20.5 mA (NAMUR NE43 compliant)

Failure Alarm [☆]

Upper: 21.6 mA or more
 Lower: 3.6 mA or less

Table 1. Ambient temperature limits/Temperature ranges of wetted parts: Flange size: 4 inches (100 mm), 3 inches (80 mm), 2 inches (50 mm), 1 1/2 inches (40 mm)

		Temperature range (°C) *1 *4				
		Regular type	High-temp. models	High-temp. Vacuum models	High-temp. High Vacuum models	Oxygen and Chlorine models
Wetted parts section	Normal operating range	-40 to +180	-5 to +280 *5	-5 to +280 *5	10 to 300 *5	-10 to +120
	Operative limit range	-50 to +185	-10 to +310 *6	-10 to +310 *6	-10 to +310 *6	-40 to +125
Ambient temperature *2 Flange size: Flush diaphragm type 3 inches (80 mm) Extended diaphragm type 4 inches (100 mm)	Normal operating range	-30 to +75	-5 to +55	-5 to +55	10 to 55	-10 to +75
	Operative limit range	-50 to +80	-10 to +60	-10 to +60	-10 to +60	-40 to +80
Ambient temperature *2 Flange size: Flush diaphragm type 2 inches (50 mm)/ 1.5 inch (40 mm) Extended diaphragm type 3 inches (80 mm)/ 2 inches (50 mm)	Normal operating range	-15 to +65	-5 to +45	-5 to +55	10 to 55	-10 to +75
	Operative limit range	-30 to +80	-10 to +55	-10 to +60	-10 to +60	-40 to +80
Specific gravity of fill liquid *3		0.935	1.07	1.07	1.09	1.87

Note) *1. See the working pressures and temperatures of the wetted parts section in Figure 1, Figure 2 and Figure 3.

*2. Ambient temperatures of the transmitter itself

*3. Approximate values at the temperature of 25 °C

*4. Note that if the operating temperature falls below the lower limit of the normal operating range, the response of the transmitter becomes slower.

*5. When the wetted parts material is tantalum, the upper limit is 180 °C.

*6. When the wetted parts material is tantalum, the upper limit is 200 °C.

Table 2. Ambient temperature limits/Temperature ranges of wetted parts: Flange size: 3/4 inches (20 mm), 1/2 inches (15 mm)

		Temperature range (°C) *1 *4			
		Regular type	High-temp. models	Oxygen and chlorine models	Fast response models
Wetted parts section	Normal operating range	-40 to +180	-5 to +280	-10 to +120	-40 to +120
	Operative limit range	-50 to +185	-10 to +310	-40 to +125	-50 to +125
Ambient temperature *2	Normal operating range	-15 to +65	-5 to +45	-10 to +75	-15 to +65
	Operative limit range	-30 to +80	-10 to +55	-40 to +80	-30 to +80
Specific gravity of fill liquid *3		0.935	1.07	1.87	0.873

Note) *1. See the working pressures and temperatures of the wetted parts section in Figure 1, Figure 2, and Figure 3.

*2. Ambient temperatures of the transmitter itself.

*3. Approximate values at the temperature of 25 °C.

*4. Note that if the operating temperature falls below the lower limit of the normal operating range, the response of the transmitter becomes slower.

For Explosion proof models with digital indicators, which have to be used within the following ranges

Normal operating condition

-20 to +70 °C

Operative limit

-30 to +80 °C

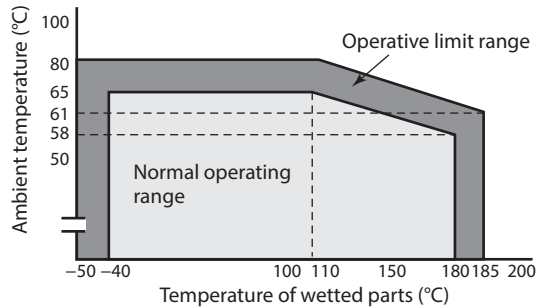

Figure 5. Ambient temperature and temperature of wetted parts section (for general purpose models)

Flange diameter:

- Flush diaphragm 2 inches (50 mm)/1 1/2 inch (40 mm)
- Extended diaphragm 3 inches (80 mm)/2 inches (50 mm)

Note) When the fill liquid is for general purposes, make sure before using your transmitter that the conditions in both Figure 1, Figure 5 and Figure 6 are met.

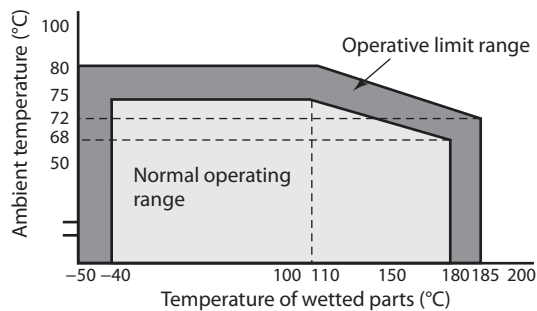

Figure 6. Ambient temperature and temperature of wetted parts section (for general purpose models)

Flange diameter:

- Flush diaphragm 3 inches (80 mm)
- Extended diaphragm 4 inches (100 mm)

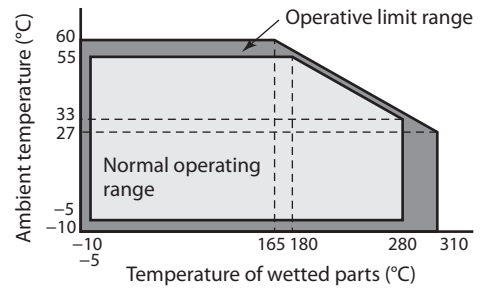

Figure 7. Ambient temperature and temperature of wetted parts section (for high temperature and vacuum 2, 3 m)

Flange diameter:

- Flush diaphragm 2 inches (50 mm)/1 1/2 inch (40 mm)

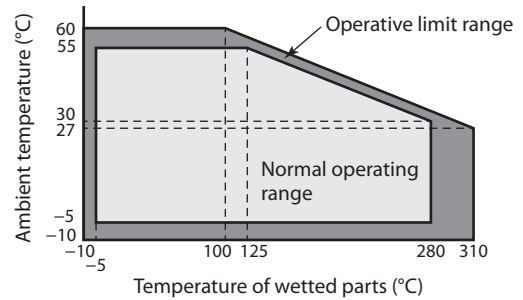

Figure 8. Ambient temperature and temperature of wetted parts section (for high temperature and vacuum 4, 5 m)

Flange diameter:

- Flush diaphragm 2 inches (50 mm)/1 1/2 inch (40 mm)

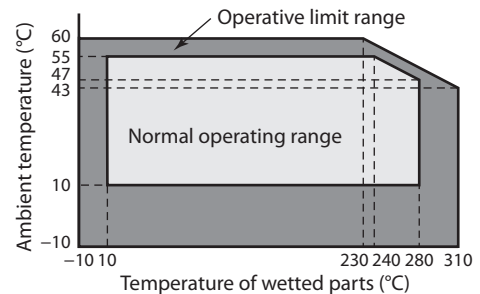

Figure 9. Ambient temperature and temperature of wetted parts section (for high temperature and high vacuum 2, 3 m)

Flange diameter:

- Flush diaphragm 2 inches (50 mm)/1 1/2 inch (40 mm)

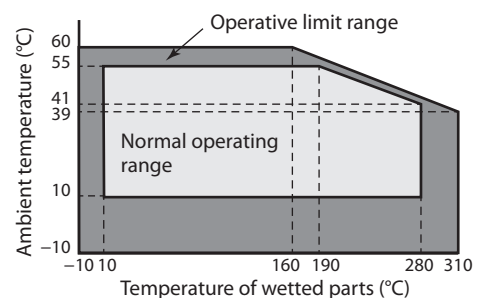

Figure 10. Ambient temperature and temperature of wetted parts section (for high temperature and high vacuum 4, 5 m)

Flange diameter:

- Flush diaphragm 2 inches (50 mm)/1 1/2 inch (40 mm)

Ambient humidity limits

5 to 100 % RH

Stability against supply voltage change

±0.005 % FS/V

Response time [★]

Approx. 700 ms (ref. value, with 5 m of ordinary capillaries, at room temp.)

Damping time [★]

Selectable from 0 to 128 sec. (HART)

Selectable from 0 to 32 sec. in ten stages (SFN)

Zero Stability

±0.5 % of URL per 10 year

Lightning protection [★]

Applicable Standards; IEC 61000-4-5

Peak value of current surge (80/20 μ sec.): 6000 A

Indicator

The digital LCD indicator (optional) shows the output in percentage or in engineering units. Range for engineering unit is from -99999 to 99999 when set at the factory, and from -19999 to 19999 when using the communicator. Specify the following items when placing order with engineering units,

- Pressure range
- Engineering unit of pressure
- Method of display, either linear or square-root.

These data may be set or changed using the communicator.

OPTIONAL SPECIFICATIONS**FEP protective film**

Use FEP protective films when corrosive fluids are used or to inhibition migration from metal diaphragms.

Working temperature range

0 to 110 °C

Working pressure range

Atmospheric pressure to flange rating (up to JIS10K, ANSI/JPI 150) (Not usable under negative pressure)

Oil free finish

The transmitter is shipped with oil-free wetted parts.

External zero/span adjustment function

The transmitter can be easily adjusted to zero or span in the field.

Indicator must be selected to enable this option.

Fieldbus type does not have span adjustment.

Elbow

This is an adaptor for changing the electrical conduit connection port from the horizontal to the vertical direction, if required by wiring conditions in the field. One or two elbows may be used as needed.

Conformance to SI units

We deliver transmitters set to any SI units as specified.

Safety Transmitter

Select this option to be used as a component of Safety Instrument System (SIS).

AT9000 is complied with IEC61508, certified according to Safety Integrity Level 2 (SIL-2)

This option is not applicable for FOUNDATION Fieldbus type, DE communication type, external zero/span adjustment (option A2), and Alarm output (option Q7).

Alarm Output (contact output)

Contact output is prepared as alarm output when alarm (Output Alarm/Sensor Temp. Alarm) condition is detected. It can be set to or Normally Close.

Contact output type : One open collector (NPN)

Contact rating: 30 V DC max., 30 mA DC max.

Residual voltage at output ON: 3.0 V max.

Operating mode: Normally Open (default)

Normally Close is not recommended.

When this option is selected, CHECK terminals for current check cannot be used.

This option is not applicable for FOUNDATION Fieldbus type, and with intrinsic safety, Type n, Nonincendive types.

Advanced diagnostics [★]

This option is applicable for FOUNDATION Fieldbus type. Refer to SS2-GTX00Z-0100.

Custom calibration

Calibrate for the specified pressure range at the factory.

PHYSICAL SPECIFICATIONS

Materials

Fill fluid

Silicone oil for general purpose and high-temperature vacuum models

Fluorine oil for oxygen and chlorine models

For specific gravity, refer to Table 1 on page 4 .

Center body

316 SST

Transmitter case

Aluminum alloy, CF8M (Equivalent to 316 SST)

Meter body cover

SCS14A (Equivalent to 316 SST)

Bolts and nuts (for fastening meter body cover)

Carbon steel (SNB7), 304 SST, 630 SST

O-ring

NBR

For wetted parts

SCS14A (316L SST for diaphragm only)

ASTM B575 (Hastelloy C-276 equivalent), Tantalum, 316L SST

Flange materials

304 SST, 316 SST, 316L SST

Mounting Bracket

Bracket

304 SST

U-bolt and nuts

304 SST

Paint

Standard: Baked acrylic paint

Corrosion-proof: Baked urethane paint

Color

Housing: Silver N-8.2

Cap: azbil bordeaux 2.5R 2.25/5

Capillary section

Capillary tube length

2, 3, 4, 5, 6, 7, 8, 9 and 10 m

2, 3, 4 and 5 m when flange diameter is flush diaphragm

2 inches (50 mm)/1 1/2 inch (40 mm)

3/4 inches (20 mm), 1/2 inches (15 mm)

extended diaphragm

3 inches (80 mm)/2 inches (50 mm)

Capillary tube material

316 SST

Armored tube material

304 SST

Coating (optional)

Olefin coating to improve corrosion resistance

(Not applicable for high-temperature/Vacuum service type and High-temperature/High-vacuum service type.)

Weight

Approx. 20.0 kg (Including ANSI 150# - 3 inches flange and capillary 5 m long)

INSTALLATION

Electrical connection

1/2 NPT internal thread, M20 internal thread.

Grounding

Resistance 100 Ω max.

Mounting

Direct mounting on the process side

Using 2-inch pipe mounting brackets: Mount the transmitter on a horizontal or vertical 2-inch pipe.

Process connection

Flange (both higher and lower pressure sides)

Flush diaphragm

JIS 10K, 20K, 30K and 63K: 40, 50, 80 mm(RF) equivalents

ANSI/JPI 150, 300 and 600: 1 1/2, 2, 3 inches (RF) equivalents

ANSI/JPI 150 and 300: 1/2, 3/4 inches (RF) equivalents

Extended diaphragm

JIS 10K, 20K and 30K: 50, 80, 100 mm(RF) equivalents

ANSI/JPI 150, 300 and 600: 2, 3 inches (RF) equivalents

ANSI/JPI 150 and 300: 4 inches (RF) equivalents

Flange standard

JIS; JIS B 2220 (2004)

ANSI; ANSI B 16.5 (1988)

JPI; JPI-7S-15-93

TRANSMITTER HANDLING NOTES

To get the most from the performance this transmitter can offer, please use it properly noting the points mentioned below. Before using it, please read the Instruction Manual.

Transmitter installation notes

WARNING

- When installing the transmitter, ensure that gaskets do not protrude from connecting points into the process (such as adapter flange connection points and connecting pipes and flanges). Failure to do so may cause a leak of process fluid, resulting in harm from burns, etc. In addition, if the process fluid contains toxic substances, take safety measures such as wearing goggles and a mask to prevent contact with the skin and eyes and to prevent inhalation.
- Use the transmitter within the operating ranges stated in the specifications (for explosion-proofing, pressure rating, temperature, humidity, voltage, vibration, shock, mounting direction, atmosphere, etc.). Using the transmitter outside the operating conditions may cause device failure or fire, resulting in a harmful physical risk of burning or the like.
- When performing wiring work in explosion-proof areas, follow the work method specified in the explosion-proof guidelines.

CAUTION

- After installation, do not use the transmitter as a foothold or put your weight on it. Doing so may cause damage.
- Be careful not to hit the glass indicator with tools etc. This could break the glass and cause injury.
- The transmitter is heavy. Wear safety shoes and take care when installing it.
- Impact to transmitter can damage sensor module.

Wiring notes

WARNING

- To avoid shocks, do not perform electrical wiring work with wet hands or with live wires.

CAUTION

- Do wiring work properly in conformance with the specifications. Wiring mistakes may result in malfunction or irreparable damage to the instrument.
- Use a power supply that conforms to the specifications. Use of an improper power supply may result in malfunction or irreparable damage to the instrument.
- Use a power supply with overcurrent protection for this instrument.

Handling precautions for HART specification devices

- If you need to operate with a secondary host (HART communicator, etc.), set the communication interval of the primary host (DCS, device management system) to 8 seconds or more, or suspend communication from the primary host. If the primary host repeats HART communication within 8 seconds, the request from the secondary host may not be received (communication may not be possible).
- If electrical noise in the environment prevents HART communications with the host, take countermeasures such as separating the signal cables from the source of the noise, improving the grounding, changing to shielded signal cables, etc. Even if noise interferes with HART communications, the 4–20 mA analog signal will be unaffected and can be used for control.
- If this product is being operated in multidrop mode, there is a limit to the number of devices that can be used. If you are using multidrop mode, please consult with us.

To use the remote seal type transmitter correctly

A various accuracy regulation and notes of the remote seal type transmitter are as follows.

A. Standard accuracy

Linearity in constant ambient temperature and constant static pressure is shown. (Refer to “PERFORMANCE SPECIFICATIONS” on page 11)

B. Ambient temperature characteristics

Accuracy by the ambient temperature change in the main body under constant static pressure is shown. (Refer to “PERFORMANCE SPECIFICATIONS” on page 11)

C. Static pressure characteristics

Accuracy by the static pressure change under constant ambient temperature is shown. (Refer to “PERFORMANCE SPECIFICATIONS” on page 11)

D. Wetted parts temperature characteristics

Zero shift is shown, when the temperature fluctuate of process wetted parts of an upper flange and lower flange changes.

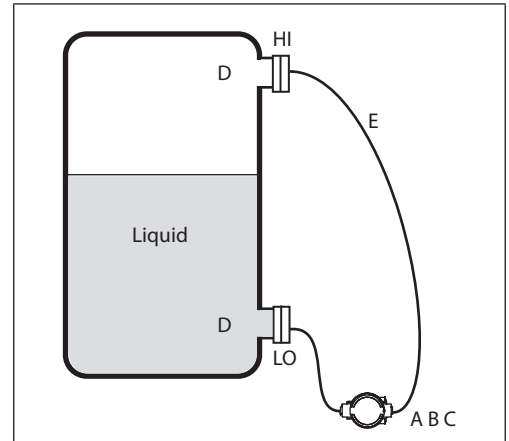

Flange type	3 inches flush diaphragm flange 4 inches Extended diaphragm flange	2 inches flush diaphragm flange 3 inches Extended diaphragm flange	1 1/2 inch flush diaphragm flange 2 inches extended diaphragm flange 1/2 inch flush diaphragm flange
Wetted parts temperature characteristics (total shift of setting ranges)	$\pm \left\{ \left(600 + \frac{2L}{50} \right) \times \frac{1}{55} \times \frac{\Delta T}{1000x} \right\} \%$	$\pm \left\{ (5 + 0.008L) \times \frac{\Delta T}{200x} \right\} \%$	$\pm \left\{ (5 + 0.008L) \times \frac{\Delta T}{100x} \right\} \%$

x : Shown for each item are the percentage ratio for x (kPa), which is the greatest value of either the upper range value (URV)*1, the lower range value (LRV)*2 or the span.

L : Flange length (mm) (In case, standard flange; $L=0$ mm)

ΔT : Temperature difference between upper flange and lower flange.

E. Temperature characteristics of capillary tube

An integrated shift is shown, when temperatures difference is generated between the upper flange side capillary tube and the lower range capillary tube by the influence of the radiant heat and the sun light in the process.

Note) Take into account the shift when the transmitter is in the following conditions.

- One side of the capillary tube is in the sun and the other side of the capillary tube is in the shade.
- Radiant heat in the process hits one side of the capillary tube.

When a temperature difference is large between the upper flange side capillary tube and the lower flange side capillary tube, take the following typical measures against the differences.

- Arrangement of the capillary tubes
- Use of moistunizing material
- Use of shielding plates against the radiant heat

Flange type	3 inches flush diaphragm flange 4 inches Extended diaphragm flange	2 inches flush diaphragm flange 3 inches Extended diaphragm flange	1 1/2 inch flush diaphragm flange 2 inches extended diaphragm flange
Fill fluid	Regular/High temp./ High-temp. and vacuum/High-temp. and high-vacuum		
Temperature characteristics of capillary (total shift of setting ranges)	$\pm \left(1.6 \times \frac{\Delta l \times \Delta T}{x} \right) \%$	$\pm \left(3.0 \times \frac{\Delta l \times \Delta T}{x} \right) \%$	$\pm \left(7.1 \times \frac{\Delta l \times \Delta T}{x} \right) \%$

Flange type	1/2 inch and 3/4 inch flush diaphragm flanges		
Flange selection	1, 3	5	6
Fill fluid	Regular/High temp.		
Temperature characteristics of capillary (total shift of setting ranges)	$\pm \left(7.1 \times \frac{\Delta l \times \Delta T}{x} \right) \%$	$\pm \left(1.2 \times \frac{\Delta l \times \Delta T}{x} \right) \%$	$\pm \left(0.7 \times \frac{\Delta l \times \Delta T}{x} \right) \%$

x : Shown for each item are the percentage ratio for x (kPa), which is the greatest value of either the upper range value (URV)*1, the lower range value (LRV)*2 or the span.

L : Length of capillary tube with temperature difference.

ΔT : Temperature difference between upper flange and lower flange.

Note) *1. URV denotes the process value for 100 % (20 mA DC) output.

*2. LRV denotes the process value for 0 % (4 mA DC) output.

F. Temperature correction function of capillary part.

The change in the density (ρ) of fill fluid is operated. As a result, the output correction is done.

[Setting method]

The height (L) between flanges of the tank is set. Please specify it when you understand height beforehand. It is not possible to set it before shipping when height is not specified. Please apply the minus to the setting of height (L) when you set up a high pressure side under the tank.

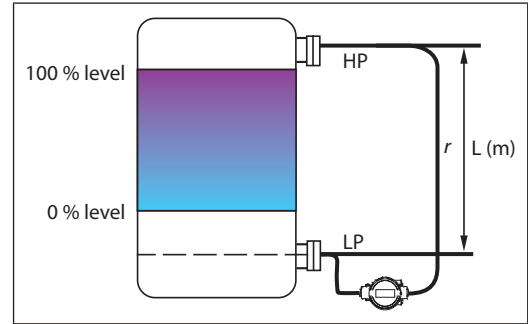

G. Installation position of Remote-sealed differential pressure transmitters.

Azbil Corporation is recommended to set up the main body of the transmitter from a lower flange downward when the transmitter is set up to the sealed tank. Please meet the following requirements when it is necessary to set up the transmitter by all means in the middle of the tank.

$$Po + ((-\rho'h)/102) \geq P \quad (1 \text{ kpa} = 102 \text{ mmH}_2\text{O})$$

$$\therefore (h \leq (Po - P)(102/\rho'))$$

- P : Permissible pressure lower bound value of the transmitter (kPa abs.)
- ρ' : Fill fluid gravity of the transmitter
- Po : Pressure in tank (kPa abs.)
- h : Distance from a lower flange (mm)

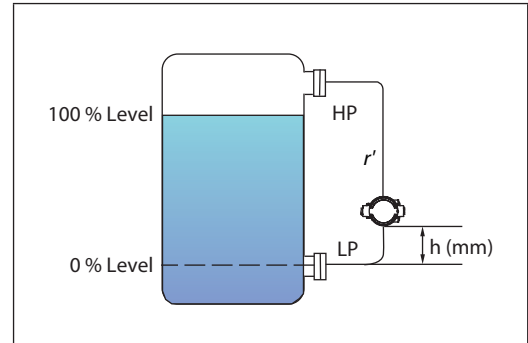

	Fill fluid gravity ρ'	Permissible pressure lower bound value P (kPa abs.)	Temperature range of wetted parts (°C)
Regular service	0.935	2	-40 to +40
High temp.	1.07	2	-5 to +90
High-temp. and vacuum	1.07	0.1333	-5 to +100
High-temp and high-vacuum	1.09	0.1333	10 to 250
Oxygen, Chlorine	1.87	54	-10 to +40

PERFORMANCE SPECIFICATIONS

Max working pressure

- Note) 1. Max. working pressure depends on flange rating, flange materials and operating temperature. Please refer to the following data.
 Operating range of temperature depends on specification of transmitters.
2. Max. working pressure depends on the smaller value of either 1.5 MPa or following data.
3. Max. working pressure depends on the smaller value of either 10 MPa or following data.

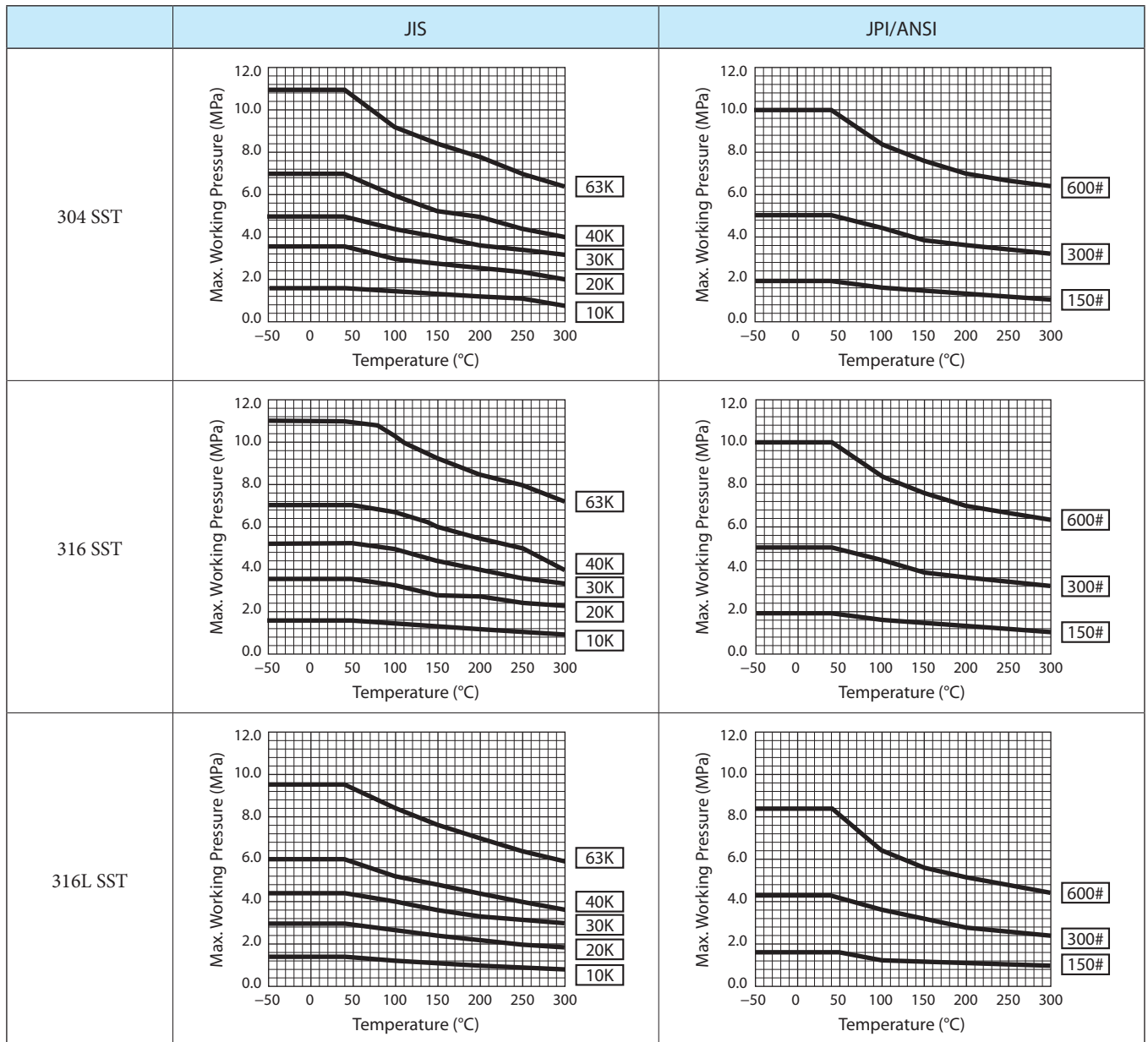

Reference accuracy

Shown for each item are the percentage ratio for x (kPa), which is the greatest value of either the upper range value (URV)*¹, the lower range value (LRV)*² or the span.

Model GTX35R (for regular type/high-temperature service/oxygen service)

Material of wetted parts: 316 SST, 316L SST

Flange size: Flush diaphragm 3 inches (80 mm) Extended diaphragm 4 inches (100 mm)

Reference accuracy * ⁴		±0.2 %	(For $x \geq 12.5$ kPa (1250 mmH ₂ O))
		$\pm \left(0.05 + 0.15 \times \frac{12.5}{x} \right) \%$	(For $x < 12.5$ kPa (1250 mmH ₂ O))
Ambient Temperature effect (Shift from the set range) Change of 30 °C (Range from -5 to +55 °C)	Combined shift	±0.71 %	(For $x \geq 25$ kPa (2500 mmH ₂ O))
		$\pm \left(0.38 + 0.33 \times \frac{25}{x} \right) \%$	(For $x < 25$ kPa (2500 mmH ₂ O))
Static pressure effect (Shift from the set range) Change of 7 MPa (70 kgf/cm ²)	Zero shift	$\pm \left(0.03 + 0.72 \times \frac{25}{x} \right) \%$	x : kPa
	Combined shift	±1.00 %	(For $x \geq 25$ kPa (2500 mmH ₂ O))
		$\pm \left(0.03 + 0.97 \times \frac{25}{x} \right) \%$	(For $x < 25$ kPa (2500 mmH ₂ O))

Model GTX40R (for regular type/high-temperature service/oxygen service)

Material of wetted parts: 316 SST, 316L SST

Flange size: Flush diaphragm 3 inches (80 mm) Extended diaphragm 4 inches (100 mm)

Reference accuracy * ³ * ⁴		±0.2 %	(For $x \geq 210$ kPa (2.1 kgf/cm ²))
		$\pm \left(0.05 + 0.15 \times \frac{210}{x} \right) \%$	(For $x < 210$ kPa (2.1 kgf/cm ²))
Ambient Temperature effect (Shift from the set range) Change of 30 °C * ³ (Range from -5 to +55 °C)	Combined shift	±0.71 %	(For $x \geq 210$ kPa (2.1 kgf/cm ²))
		$\pm \left(0.38 + 0.33 \times \frac{210}{x} \right) \%$	(For $x < 210$ kPa (2.1 kgf/cm ²))
Static pressure effect (Shift from the set range) Change of 7 MPa (70 kgf/cm ²)	Zero shift	$\pm \left(0.03 + 0.47 \times \frac{700}{x} \right) \%$	x : kPa
	Combined shift	$\pm \left(0.03 + 0.72 \times \frac{700}{x} \right) \%$	x : kPa

Model GTX35R (for regular type/high-temperature service/oxygen service) (for option "M5", 0.1 mm thickness diaphragm)

Material of wetted parts: 316 SST, 316L SST

Flange size: Flush diaphragm 3 inches (80 mm) Extended diaphragm 4 inches (100 mm)

Reference accuracy * ⁴		±0.4 %	(For $x \geq 12.5$ kPa (1250 mmH ₂ O))
		$\pm \left(0.1 + 0.3 \times \frac{12.5}{x} \right) \%$	(For $x < 12.5$ kPa (1250 mmH ₂ O))
Ambient Temperature effect (Shift from the set range) Change of 30 °C (Range from -5 to +55 °C)	Combined shift	±2.84 %	(For $x \geq 25$ kPa (2500 mmH ₂ O))
		$\pm \left(1.52 + 1.32 \times \frac{25}{x} \right) \%$	(For $x < 25$ kPa (2500 mmH ₂ O))
Static pressure effect (Shift from the set range) Change of 7 MPa (70 kgf/cm ²)	Zero shift	$\pm \left(0.06 + 1.44 \times \frac{25}{x} \right) \%$	x : kPa
	Combined shift	±2.00 %	(For $x \geq 25$ kPa (2500 mmH ₂ O))
		$\pm \left(0.06 + 1.94 \times \frac{25}{x} \right) \%$	(For $x < 25$ kPa (2500 mmH ₂ O))

*1. URV denotes the process value for 100 % (20 mA DC) output.

*2. LRV denotes the process value for 0 % (4 mA DC) output.

*3. Within a range of $URV \geq 0$ and $LRV \geq 0$.

*4. Reference accuracy at calibrated condition.

Model GTX35R (for regular type/high-temperature/oxygen/chlorine service)

Material of wetted parts: ASTM B575 (Hastelloy C-276 equivalent), Tantalum

Flange size: Flush diaphragm 3 inches (80 mm)

Reference accuracy *4		±0.4 %	(For $x \geq 12.5$ kPa (1250 mmH ₂ O))
		$\pm \left(0.25 + 0.15 \times \frac{12.5}{x} \right)$ %	(For $x < 12.5$ kPa (1250 mmH ₂ O))
Ambient Temperature effect (Shift from the set range) Change of 30 °C (Range from -5 to +55 °C)	Combined shift	±1.36 %	(For $x \geq 25$ kPa (2500 mmH ₂ O))
		$\pm \left(0.69 + 0.67 \times \frac{25}{x} \right)$ %	(For $x < 25$ kPa (2500 mmH ₂ O))
Static pressure effect (Shift from the set range) Change of 7 MPa (70 kgf/cm ²)	Zero shift	±1.5 %	(For $x \geq 25$ kPa (2500 mmH ₂ O))
		$\pm \left(1.5 \times \frac{25}{x} \right)$ %	(For $x < 25$ kPa (2500 mmH ₂ O))
	Combined shift	±2.0 %	(For $x \geq 25$ kPa (2500 mmH ₂ O))
		$\pm \left(2.0 \times \frac{25}{x} \right)$ %	(For $x < 25$ kPa (2500 mmH ₂ O))

Model GTX40R (for regular type/high-temperature/oxygen/chlorine service)

Material of wetted parts: ASTM B575 (Hastelloy C-276 equivalent), Tantalum

Flange size: Flush diaphragm 3 inches (80 mm)

Reference accuracy *3 *4		±0.2 %	(For $x \geq 210$ kPa (2.1 kgf/cm ²))
		$\pm \left(0.05 + 0.15 \times \frac{210}{x} \right)$ %	(For $x < 210$ kPa (2.1 kgf/cm ²))
Ambient Temperature effect (Shift from the set range) Change of 30 °C *3 (Range from -5 to +55 °C)	Combined shift	±1.75 %	(For $x \geq 210$ kPa (2.1 kgf/cm ²))
		$\pm \left(1.00 + 0.75 \times \frac{210}{x} \right)$ %	(For $x < 210$ kPa (2.1 kgf/cm ²))
Static pressure effect (Shift from the set range) Change of 7 MPa (70 kgf/cm ²)	Zero shift	$\pm \left(0.75 \times \frac{700}{x} \right)$ %	x: kPa
	Combined shift	$\pm \left(1.00 \times \frac{700}{x} \right)$ %	x: kPa

Model GTX40R (for regular type/high-temperature service/oxygen service) (For option "M5", 0.1 mm thickness diaphragm)

Material of wetted parts: 316 SST, 316L SST

Flange size: Flush diaphragm 3 inches (80 mm)

Reference accuracy *3 *4		±0.4 %	(For $x \geq 210$ kPa (2.1 kgf/cm ²))
		$\pm \left(0.1 + 0.3 \times \frac{210}{x} \right)$ %	(For $x < 210$ kPa (2.1 kgf/cm ²))
Ambient Temperature effect (Shift from the set range) Change of 30 °C *3 (Range from -5 to +55 °C)	Combined shift	±2.84 %	(For $x \geq 210$ kPa (2.1 kgf/cm ²))
		$\pm \left(1.52 + 1.32 \times \frac{210}{x} \right)$ %	(For $x < 210$ kPa (2.1 kgf/cm ²))
Static pressure effect (Shift from the set range) Change of 7 MPa (70 kgf/cm ²)	Zero shift	$\pm \left(0.06 + 0.94 \times \frac{700}{x} \right)$ %	x: kPa
	Combined shift	$\pm \left(0.06 + 1.44 \times \frac{700}{x} \right)$ %	x: kPa

*3. Within a range of $URV \geq 0$ and $LRV \geq 0$.

*4. Reference accuracy at calibrated condition.

Model GTX35R (for regular type/high-temperature service/oxygen service)

Material of wetted parts: 316 SST, 316L SST

Flange size: Flush diaphragm 2 inches (50 mm) Extended diaphragm 3 inches (80 mm)

Reference accuracy *4		±0.2 %	(For x≥12.5 kPa (1250 mmH ₂ O))
		$\pm (0.05+0.15 \times \frac{12.5}{x}) \%$	(For x<12.5 kPa (1250 mmH ₂ O))
Ambient Temperature effect (Shift from the set range) Change of 30 °C (Range from -5 to +55 °C)	Combined shift	±0.88 %	(For x≥25 kPa (2500 mmH ₂ O))
		$\pm (0.55+0.33 \times \frac{25}{x}) \%$	(For x<25 kPa (2500 mmH ₂ O))
Static pressure effect (Shift from the set range) Change of 7 MPa (70 kgf/cm ²)	Zero shift	$\pm (0.03+1.44 \times \frac{25}{x}) \%$	x: kPa
	Combined shift	±1.97 %	(For x≥25 kPa (2500 mmH ₂ O))
		$\pm (0.03+1.94 \times \frac{25}{x}) \%$	(For x<25 kPa (2500 mmH ₂ O))

Model GTX35R (for regular type/oxygen service), (capillary length up to 3 m)

Material of wetted parts: 316 SST, 316L SST

Flange size: Flush diaphragm 1 1/2 inch (40 mm), 3/4 inches (20 mm), 1/2 inches (15 mm)

Flange type code “1, 3”

Reference accuracy *4		±0.3 %	(For x≥12.5 kPa (1250 mmH ₂ O))
		$\pm (0.15+0.15 \times \frac{12.5}{x}) \%$	(For x<12.5 kPa (1250 mmH ₂ O))
Ambient Temperature effect (Shift from the set range) Change of 30 °C (Range from -5 to +55 °C)	Combined shift	±0.88 %	(For x≥25 kPa (2500 mmH ₂ O))
		$\pm (0.55+0.33 \times \frac{25}{x}) \%$	(For x<25 kPa (2500 mmH ₂ O))
Static pressure effect (Shift from the set range) Change of 7 MPa (70 kgf/cm ²)	Zero shift	$\pm (0.03+1.44 \times \frac{25}{x}) \%$	x: kPa
	Combined shift	±1.97 %	(For x≥25 kPa (2500 mmH ₂ O))
		$\pm (0.03+1.94 \times \frac{25}{x}) \%$	(For x<25 kPa (2500 mmH ₂ O))

Model GTX35R (for regular type/oxygen service), (capillary length 4 m and 5 m)

Model GTX35R (for high-temperature service)

Material of wetted parts: 316 SST, 316L SST

Flange size: Flush diaphragm 1 1/2 inch (40 mm), 3/4 inches (20 mm), 1/2 inches (15 mm)

Reference accuracy *4		±0.3 %	(For x≥12.5 kPa (1250 mmH ₂ O))
		$\pm (0.15+0.15 \times \frac{12.5}{x}) \%$	(For x<12.5 kPa (1250 mmH ₂ O))
Ambient Temperature effect (Shift from the set range) Change of 30 °C (Range from -5 to +55 °C)	Combined shift	±6.54%	(For x≥25 kPa (2500 mmH ₂ O))
		$\pm (6.21+0.33 \times \frac{25}{x}) \%$	(For x<25 kPa (2500 mmH ₂ O))
Static pressure effect (Shift from the set range) Change of 7 MPa (70 kgf/cm ²)	Zero shift	±2.7 %	(For x≥25 kPa (2500 mmH ₂ O))
		$\pm (2.7 \times \frac{25}{x}) \%$	(For x<25 kPa (2500 mmH ₂ O))
	Combined shift	±3.5%	(For x≥25 kPa (2500 mmH ₂ O))
		$\pm (3.5 \times \frac{25}{x}) \%$	(For x<25 kPa (2500 mmH ₂ O))

*3. Within a range of URV≥0 and LRV≥0.

*4. Reference accuracy at calibrated condition.

Model GTX35R (for regular type/high-temperature service/oxygen service)

Material of wetted parts: 316 SST, 316L SST

Flange size: Extended diaphragm 2 inches (50 mm)

Reference accuracy *4		±0.3 %	(For $x \geq 12.5$ kPa (1250 mmH ₂ O))
		$\pm \left(0.15 + 0.15 \times \frac{12.5}{x} \right) \%$	(For $x < 12.5$ kPa (1250 mmH ₂ O))
Ambient Temperature effect (Shift from the set range) Change of 30 °C (Range from -5 to +55 °C)	Combined shift	±6.54 %	(For $x \geq 25$ kPa (2500 mmH ₂ O))
		$\pm \left(6.21 + 0.33 \times \frac{25}{x} \right) \%$	(For $x < 25$ kPa (2500 mmH ₂ O))
Static pressure effect (Shift from the set range) Change of 7 MPa (70 kgf/cm ²)	Zero shift	±2.7 %	(For $x \geq 25$ kPa (2500 mmH ₂ O))
		$\pm \left(2.7 \times \frac{25}{x} \right) \%$	(For $x < 25$ kPa (2500 mmH ₂ O))
	Combined shift	±3.5 %	(For $x \geq 25$ kPa (2500 mmH ₂ O))
		$\pm \left(3.5 \times \frac{25}{x} \right) \%$	(For $x < 25$ kPa (2500 mmH ₂ O))

Model GTX35R (for regular type/high-temperature/oxygen/chlorine service)

Material of wetted parts: ASTM B575 (Hastelloy C-276 equivalent), Tantalum

Flange size: Flush diaphragm 2 inches (50 mm), 1 1/2 inch (40 mm), 3/4 inches (20 mm), 1/2 inches (15 mm)

Flange type code "1, 3"

Reference accuracy *4		±0.4 %	(For $x \geq 12.5$ kPa (1250 mmH ₂ O))
		$\pm \left(0.25 + 0.15 \times \frac{12.5}{x} \right) \%$	(For $x < 12.5$ kPa (1250 mmH ₂ O))
Ambient Temperature effect (Shift from the set range) Change of 30 °C (Range from -5 to +55 °C)	Combined shift	±6.54 %	(For $x \geq 25$ kPa (2500 mmH ₂ O))
		$\pm \left(5.87 + 0.67 \times \frac{25}{x} \right) \%$	(For $x < 25$ kPa (2500 mmH ₂ O))
Static pressure effect (Shift from the set range) Change of 7 MPa (70 kgf/cm ²)	Zero shift	±6.00 %	(For $x \geq 25$ kPa (2500 mmH ₂ O))
		$\pm \left(6.00 \times \frac{25}{x} \right) \%$	(For $x < 25$ kPa (2500 mmH ₂ O))
	Combined shift	±7.00 %	(For $x \geq 25$ kPa (2500 mmH ₂ O))
		$\pm \left(7.00 \times \frac{25}{x} \right) \%$	(For $x < 25$ kPa (2500 mmH ₂ O))

Model GTX35R (for low temperature/fast response service)

Material of wetted parts: 316 SST

Flange size: Flush diaphragm 3/4 inches (20 mm), 1/2 inches (15 mm) Flange type code "1, 3"

Reference accuracy *4		±0.3 %	(For $x \geq 12.5$ kPa (1250 mmH ₂ O))
		$\pm \left(0.15 + 0.15 \times \frac{12.5}{x} \right) \%$	(For $x < 12.5$ kPa (1250 mmH ₂ O))
Ambient Temperature effect (Shift from the set range) Change of 30 °C (Range from -5 to +55 °C)	Combined shift	±6.54 %	(For $x \geq 25$ kPa (2500 mmH ₂ O))
		$\pm \left(5.87 + 0.67 \times \frac{25}{x} \right) \%$	(For $x < 25$ kPa (2500 mmH ₂ O))
Static pressure effect (Shift from the set range) Change of 7 MPa (70 kgf/cm ²)	Zero shift	±2.7 %	(For $x \geq 25$ kPa (2500 mmH ₂ O))
		$\pm \left(2.7 \times \frac{25}{x} \right) \%$	(For $x < 25$ kPa (2500 mmH ₂ O))
	Combined shift	±3.5 %	(For $x \geq 25$ kPa (2500 mmH ₂ O))
		$\pm \left(3.5 \times \frac{25}{x} \right) \%$	(For $x < 25$ kPa (2500 mmH ₂ O))

*3. Within a range of URV ≥ 0 and LRV ≥ 0 .

*4. Reference accuracy at calibrated condition.

Model GTX40R (for regular type/high-temperature service/oxygen service)

Material of wetted parts: 316 SST, 316L SST

Flange size: Flush diaphragm 2 inches (50 mm), 1 1/2 inch (40 mm), 3/4 inches (20 mm), 1/2 inches (15 mm)

Flange type code "1, 3"

Extended diaphragm 3 inches (80 mm), 2 inches (50 mm)

Reference accuracy *3 *4		$\pm 0.2 \%$	(For $x \geq 210$ kPa (2.1 kgf/cm ²))
		$\pm \left(0.05 + 0.15 \times \frac{210}{x} \right) \%$	(For $x < 210$ kPa (2.1 kgf/cm ²))
Ambient Temperature effect (Shift from the set range) Change of 30 °C *3 (Range from -5 to +55 °C)	Combined shift	$\pm 1.53 \%$	(For $x \geq 210$ kPa (2.1 kgf/cm ²))
		$\pm \left(1.2 + 0.33 \times \frac{210}{x} \right) \%$	(For $x < 210$ kPa (2.1 kgf/cm ²))
Static pressure effect (Shift from the set range) Change of 7 MPa (70 kgf/cm ²)	Zero shift	$\pm \left(0.03 + 0.47 \times \frac{700}{x} \right) \%$	x: kPa
	Combined shift	$\pm \left(0.03 + 0.72 \times \frac{700}{x} \right) \%$	x: kPa

Model GTX40R (for regular type/high-temperature/oxygen/chlorine service)

Material of wetted parts: ASTM B575 (Hastelloy C-276 equivalent), Tantalum

Flange size: Flush diaphragm 2 inches (50 mm), 1 1/2 inch (40 mm)

Reference accuracy *3 *4		$\pm 0.2 \%$	(For $x \geq 210$ kPa (2.1 kgf/cm ²))
		$\pm \left(0.05 + 0.15 \times \frac{210}{x} \right) \%$	(For $x < 210$ kPa (2.1 kgf/cm ²))
Ambient Temperature effect (Shift from the set range) Change of 30 °C *3 (Range from -5 to +55 °C)	Combined shift	$\pm 3.0 \%$	(For $x \geq 210$ kPa (2.1 kgf/cm ²))
		$\pm \left(2.2 + 0.8 \times \frac{210}{x} \right) \%$	(For $x < 210$ kPa (2.1 kgf/cm ²))
Static pressure effect (Shift from the set range) Change of 7 MPa (70 kgf/cm ²)	Zero shift	$\pm \left(0.75 \times \frac{700}{x} \right) \%$	x: kPa
	Combined shift	$\pm \left(1.0 \times \frac{700}{x} \right) \%$	x: kPa

Model GTX35R (for high temperature and vacuum/high temperature and high vacuum)

Material of wetted parts: 316 SST, 316L SST

Flange size: Flush diaphragm 3 inches (80 mm) Extended diaphragm 4 inches (100 mm)

Reference accuracy *4		$\pm 0.3 \%$	(For $x \geq 12.5$ kPa (1250 mmH ₂ O))
		$\pm \left(0.15 + 0.15 \times \frac{12.5}{x} \right) \%$	(For $x < 12.5$ kPa (1250 mmH ₂ O))
Ambient Temperature effect (Shift from the set range) Change of 30 °C (Range from -5 to +55 °C)	Combined shift	$\pm 1.36 \%$	(For $x \geq 25$ kPa (2500 mmH ₂ O))
		$\pm \left(0.69 + 0.67 \times \frac{25}{x} \right) \%$	(For $x < 25$ kPa (2500 mmH ₂ O))
Static pressure effect (Shift from the set range) Change of 7 MPa (70 kgf/cm ²)	Zero shift	$\pm 1.5 \%$	(For $x \geq 25$ kPa (2500 mmH ₂ O))
		$\pm \left(1.5 \times \frac{25}{x} \right) \%$	(For $x < 25$ kPa (2500 mmH ₂ O))
	Combined shift	$\pm 2.0 \%$	(For $x \geq 25$ kPa (2500 mmH ₂ O))
		$\pm \left(2.0 \times \frac{25}{x} \right) \%$	(For $x < 25$ kPa (2500 mmH ₂ O))

*3. Within a range of $URV \geq 0$ and $LRV \geq 0$.

*4. Reference accuracy at calibrated condition.

Model GTX40R (for high temperature and vacuum/high temperature and high vacuum)

Material of wetted parts: 316 SST, 316L SST

Flange size: Flush diaphragm 3 inches (80 mm) Extended diaphragm 4 inches (100 mm)

Reference accuracy *3 *4		±0.2 %	(For $x \geq 210$ kPa (2.1 kgf/cm ²))
		$\pm \left(0.05 + 0.15 \times \frac{210}{x} \right) \%$	(For $x < 210$ kPa (2.1 kgf/cm ²))
Ambient Temperature effect (Shift from the set range) Change of 30 °C *3 (Range from -5 to +55 °C)	Combined shift	±1.67 %	(For $x \geq 210$ kPa (2.1 kgf/cm ²))
		$\pm \left(1.00 + 0.67 \times \frac{210}{x} \right) \%$	(For $x < 210$ kPa (2.1 kgf/cm ²))
Static pressure effect (Shift from the set range) Change of 7 MPa (70 kgf/cm ²)	Zero shift	$\pm \left(0.75 \times \frac{700}{x} \right) \%$	x : kPa
	Combined shift	$\pm \left(1.00 \times \frac{700}{x} \right) \%$	x : kPa

Model GTX35R (for high temperature and vacuum/high temperature and high vacuum)

Material of wetted parts: ASTM B575 (Hastelloy C-276 equivalent), Tantalum

Flange size: Flush diaphragm 3 inches (80 mm)

Reference accuracy *4		±0.4 %	(For $x \geq 12.5$ kPa (1250 mmH ₂ O))
		$\pm \left(0.25 + 0.15 \times \frac{12.5}{x} \right) \%$	(For $x < 12.5$ kPa (1250 mmH ₂ O))
Ambient Temperature effect (Shift from the set range) Change of 30 °C (Range from -5 to +55 °C)	Combined shift	±3.0 %	(For $x \geq 25$ kPa (2500 mmH ₂ O))
		$\pm \left(2.33 + 0.67 \times \frac{25}{x} \right) \%$	(For $x < 25$ kPa (2500 mmH ₂ O))
Static pressure effect (Shift from the set range) Change of 7 MPa (70 kgf/cm ²)	Zero shift	±1.5 %	(For $x \geq 25$ kPa (2500 mmH ₂ O))
		$\pm \left(1.5 \times \frac{25}{x} \right) \%$	(For $x < 25$ kPa (2500 mmH ₂ O))
	Combined shift	±2.0 %	(For $x \geq 25$ kPa (2500 mmH ₂ O))
		$\pm \left(2.0 \times \frac{25}{x} \right) \%$	(For $x < 25$ kPa (2500 mmH ₂ O))

Model GTX40R (for high temperature and vacuum/high temperature and high vacuum)

Material of wetted parts: ASTM B575 (Hastelloy C-276 equivalent), Tantalum

Flange size: Flush diaphragm 3 inches (80 mm)

Reference accuracy *3 *4		±0.2 %	(For $x \geq 210$ kPa (2.1 kgf/cm ²))
		$\pm \left(0.05 + 0.15 \times \frac{210}{x} \right) \%$	(For $x < 210$ kPa (2.1 kgf/cm ²))
Ambient Temperature effect (Shift from the set range) Change of 30 °C *3 (Range from -5 to +55 °C)	Combined shift	±1.75 %	(For $x \geq 210$ kPa (2.1 kgf/cm ²))
		$\pm \left(1.00 + 0.75 \times \frac{210}{x} \right) \%$	(For $x < 210$ kPa (2.1 kgf/cm ²))
Static pressure effect (Shift from the set range) Change of 7 MPa (70 kgf/cm ²)	Zero shift	$\pm \left(0.75 \times \frac{700}{x} \right) \%$	x : kPa
	Combined shift	$\pm \left(1.00 \times \frac{700}{x} \right) \%$	x : kPa

*3. Within a range of URV ≥ 0 and LRV ≥ 0 .

*4. Reference accuracy at calibrated condition.

Model GTX35R (for high temperature and vacuum/high temperature and high vacuum)

Material of wetted parts: 316 SST, 316L SST

Flange size: Flush diaphragm 2 inches (50 mm), Extended diaphragm 3 inch (80 mm)

Reference accuracy *4		$\pm 0.3 \%$	(For $x \geq 12.5$ kPa (1250 mmH ₂ O))
		$\pm \left(0.15 + 0.15 \times \frac{12.5}{x} \right) \%$	(For $x < 12.5$ kPa (1250 mmH ₂ O))
Ambient Temperature effect (Shift from the set range) Change of 30 °C (Range from -5 to +55 °C)	Combined shift	$\pm 4.0 \%$	(For $x \geq 25$ kPa (2500 mmH ₂ O))
		$\pm \left(3.33 + 0.67 \times \frac{25}{x} \right) \%$	(For $x < 25$ kPa (2500 mmH ₂ O))
Static pressure effect (Shift from the set range) Change of 7 MPa (70 kgf/cm ²)	Zero shift	$\pm 6.0 \%$	(For $x \geq 25$ kPa (2500 mmH ₂ O))
		$\pm \left(6.0 \times \frac{25}{x} \right) \%$	(For $x < 25$ kPa (2500 mmH ₂ O))
	Combined shift	$\pm 7.0 \%$	(For $x \geq 25$ kPa (2500 mmH ₂ O))
		$\pm \left(7.0 \times \frac{25}{x} \right) \%$	(For $x < 25$ kPa (2500 mmH ₂ O))

Model GTX35R (for high temperature and vacuum/high temperature and high vacuum)

Material of wetted parts: 316 SST, 316L SST

Flange size: Flush diaphragm 1 1/2 inches (40 mm), Extended diaphragm 2 inches (50 mm)

Reference accuracy *4		$\pm 0.3 \%$	(For $x \geq 12.5$ kPa (1250 mmH ₂ O))
		$\pm \left(0.15 + 0.15 \times \frac{12.5}{x} \right) \%$	(For $x < 12.5$ kPa (1250 mmH ₂ O))
Ambient Temperature effect (Shift from the set range) Change of 30 °C (Range from -5 to +55 °C)	Combined shift	$\pm 6.54 \%$	(For $x \geq 25$ kPa (2500 mmH ₂ O))
		$\pm \left(5.87 + 0.67 \times \frac{25}{x} \right) \%$	(For $x < 25$ kPa (2500 mmH ₂ O))
Static pressure effect (Shift from the set range) Change of 7 MPa (70 kgf/cm ²)	Zero shift	$\pm 6.0 \%$	(For $x \geq 25$ kPa (2500 mmH ₂ O))
		$\pm \left(6.0 \times \frac{25}{x} \right) \%$	(For $x < 25$ kPa (2500 mmH ₂ O))
	Combined shift	$\pm 7.0 \%$	(For $x \geq 25$ kPa (2500 mmH ₂ O))
		$\pm \left(7.0 \times \frac{25}{x} \right) \%$	(For $x < 25$ kPa (2500 mmH ₂ O))

Model GTX40R (for high temperature and vacuum/high temperature and high vacuum)

Material of wetted parts: 316 SST, 316L SST

Flange size: Flush diaphragm 2 inches (50 mm), Extended diaphragm 3 inches (80 mm)

Reference accuracy *3 *4		$\pm 0.2 \%$	(For $x \geq 210$ kPa (2.1 kgf/cm ²))
		$\pm \left(0.05 + 0.15 \times \frac{210}{x} \right) \%$	(For $x < 210$ kPa (2.1 kgf/cm ²))
Ambient Temperature effect (Shift from the set range) Change of 30 °C *3 (Range from -5 to +55 °C)	Combined shift	$\pm 1.87 \%$	(For $x \geq 210$ kPa (2.1 kgf/cm ²))
		$\pm \left(1.2 + 0.67 \times \frac{210}{x} \right) \%$	(For $x < 210$ kPa (2.1 kgf/cm ²))
Static pressure effect (Shift from the set range) Change of 7 MPa (70 kgf/cm ²)	Zero shift	$\pm \left(0.75 \times \frac{700}{x} \right) \%$	x: kPa
	Combined shift	$\pm \left(1.0 \times \frac{700}{x} \right) \%$	x: kPa

*3. Within a range of URV ≥ 0 and LRV ≥ 0 .

*4. Reference accuracy at calibrated condition.

Model GTX40R (for high temperature and vacuum/high temperature and high vacuum)

Material of wetted parts: 316 SST, 316L SST

Flange size: Flush diaphragm 1 1/2 inches (40 mm), Extended diaphragm 2 inch (50 mm)

Reference accuracy *4		±0.2 %	(For $x \geq 12.5$ kPa (1250 mmH ₂ O))
		$\pm \left(0.05 + 0.15 \times \frac{12.5}{x} \right) \%$	(For $x < 12.5$ kPa (1250 mmH ₂ O))
Ambient Temperature effect (Shift from the set range) Change of 30 °C (Range from -5 to +55 °C)	Combined shift	±2.87 %	(For $x \geq 25$ kPa (2500 mmH ₂ O))
		$\pm \left(2.2 + 0.67 \times \frac{25}{x} \right) \%$	(For $x < 25$ kPa (2500 mmH ₂ O))
Static pressure effect (Shift from the set range) Change of 7 MPa (70 kgf/cm ²)	Zero shift	$\pm \left(0.75 \times \frac{700}{x} \right) \%$	x : kPa
	Combined shift	$\pm \left(1.0 \times \frac{700}{x} \right) \%$	x : kPa

Model GTX35R (for high temperature and vacuum/high temperature and high vacuum)

Material of wetted parts: ASTM B575 (Hastelloy C-276 equivalent), Tantalum

Flange size: Flush diaphragm 2 inches (50 mm), 1 1/2 inch (40 mm)

Reference accuracy *4		±0.4 %	(For $x \geq 12.5$ kPa (1250 mmH ₂ O))
		$\pm \left(0.25 + 0.15 \times \frac{12.5}{x} \right) \%$	(For $x < 12.5$ kPa (1250 mmH ₂ O))
Ambient Temperature effect (Shift from the set range) Change of 30 °C (Range from -5 to +55 °C)	Combined shift	±6.54 %	(For $x \geq 25$ kPa (2500 mmH ₂ O))
		$\pm \left(5.87 + 0.67 \times \frac{25}{x} \right) \%$	(For $x < 25$ kPa (2500 mmH ₂ O))
Static pressure effect (Shift from the set range) Change of 7 MPa (70 kgf/cm ²)	Zero shift	±6.00 %	(For $x \geq 25$ kPa (2500 mmH ₂ O))
		$\pm \left(6.00 \times \frac{25}{x} \right) \%$	(For $x < 25$ kPa (2500 mmH ₂ O))
	Combined shift	±7.00 %	(For $x \geq 25$ kPa (2500 mmH ₂ O))
		$\pm \left(7.00 \times \frac{25}{x} \right) \%$	(For $x < 25$ kPa (2500 mmH ₂ O))

Model GTX40R (for high temperature and vacuum/high temperature and high vacuum)

Material of wetted parts: ASTM B575 (Hastelloy C-276 equivalent), Tantalum

Flange size: Flush diaphragm 2 inches (50 mm), 1 1/2 inch (40 mm)

Reference accuracy *3 *4		±0.2 %	(For $x \geq 210$ kPa (2.1 kgf/cm ²))
		$\pm \left(0.05 + 0.15 \times \frac{210}{x} \right) \%$	(For $x < 210$ kPa (2.1 kgf/cm ²))
Ambient Temperature effect (Shift from the set range) Change of 30 °C *3 (Range from -5 to +55 °C)	Combined shift	±3.0 %	(For $x \geq 210$ kPa (2.1 kgf/cm ²))
		$\pm \left(2.2 + 0.8 \times \frac{210}{x} \right) \%$	(For $x < 210$ kPa (2.1 kgf/cm ²))
Static pressure effect (Shift from the set range) Change of 7 MPa (70 kgf/cm ²)	Zero shift	$\pm \left(0.75 \times \frac{700}{x} \right) \%$	x : kPa
	Combined shift	$\pm \left(1.0 \times \frac{700}{x} \right) \%$	x : kPa

*3. Within a range of URV \geq 0 and LRV \geq 0.

*4. Reference accuracy at calibrated condition.

Model GTX35R (for regular type/high temperature service)

Material of wetted parts: 316 SST

Flange size: Flush diaphragm 3/4 inches (20 mm), 1/2 inch (15 mm) Flange type code "6"

Reference accuracy *4		±0.2 %	(For $x \geq 12.5$ kPa (1250 mmH ₂ O))
		$\pm \left(0.05 + 0.15 \times \frac{12.5}{x} \right) \%$	(For $x < 12.5$ kPa (1250 mmH ₂ O))
Ambient Temperature effect (Shift from the set range) Change of 30 °C (Range from -5 to +55 °C)	Combined shift	±0.77 %	(For $x \geq 25$ kPa (2500 mmH ₂ O))
		$\pm \left(0.38 + 0.39 \times \frac{25}{x} \right) \%$	(For $x < 25$ kPa (2500 mmH ₂ O))
Static pressure effect (Shift from the set range) Change of 7 MPa (70 kgf/cm ²)	Zero shift	±1.23 %	(For $x \geq 25$ kPa (2500 mmH ₂ O))
		$\pm \left(1.23 \times \frac{25}{x} \right) \%$	(For $x < 25$ kPa (2500 mmH ₂ O))
	Combined shift	±1.65 %	(For $x \geq 25$ kPa (2500 mmH ₂ O))
		$\pm \left(1.65 \times \frac{25}{x} \right) \%$	(For $x < 25$ kPa (2500 mmH ₂ O))

Model GTX35R (for regular type/high temperature service)

Material of wetted parts: 316 SST

Flange size: Flush diaphragm 3/4 inches (20 mm), 1/2 inch (15 mm) Flange type code "5"

Reference accuracy *4		±0.2 %	(For $x \geq 12.5$ kPa (1250 mmH ₂ O))
		$\pm \left(0.05 + 0.15 \times \frac{12.5}{x} \right) \%$	(For $x < 12.5$ kPa (1250 mmH ₂ O))
Ambient Temperature effect (Shift from the set range) Change of 30 °C (Range from -5 to +55 °C)	Combined shift	±0.81 %	(For $x \geq 25$ kPa (2500 mmH ₂ O))
		$\pm \left(0.38 + 0.43 \times \frac{25}{x} \right) \%$	(For $x < 25$ kPa (2500 mmH ₂ O))
Static pressure effect (Shift from the set range) Change of 7 MPa (70 kgf/cm ²)	Zero shift	±1.47 %	(For $x \geq 25$ kPa (2500 mmH ₂ O))
		$\pm \left(1.47 \times \frac{25}{x} \right) \%$	(For $x < 25$ kPa (2500 mmH ₂ O))
	Combined shift	±1.97 %	(For $x \geq 25$ kPa (2500 mmH ₂ O))
		$\pm \left(1.97 \times \frac{25}{x} \right) \%$	(For $x < 25$ kPa (2500 mmH ₂ O))

Model GTX35R (for regular type/high temperature service)

Material of wetted parts: ASTM B575 (Hastelloy C-276 equivalent)

Flange size: Flush diaphragm 3/4 inches (20 mm), 1/2 inch (15 mm) Flange type code "5"

Reference accuracy *4		±0.3 %	(For $x \geq 12.5$ kPa (1250 mmH ₂ O))
		$\pm \left(0.05 + 0.25 \times \frac{12.5}{x} \right) \%$	(For $x < 12.5$ kPa (1250 mmH ₂ O))
Ambient Temperature effect (Shift from the set range) Change of 30 °C (Range from -5 to +55 °C)	Combined shift	$\pm \left(1.0 + 1.05 \times \frac{25}{x} \right) \%$	
Static pressure effect (Shift from the set range) Change of 7 MPa (70 kgf/cm ²)	Zero shift	±6.00 %	(For $x \geq 25$ kPa (2500 mmH ₂ O))
		$\pm \left(6.00 \times \frac{25}{x} \right) \%$	(For $x < 25$ kPa (2500 mmH ₂ O))
	Combined shift	±7.00 %	(For $x \geq 25$ kPa (2500 mmH ₂ O))
		$\pm \left(7.00 \times \frac{25}{x} \right) \%$	(For $x < 25$ kPa (2500 mmH ₂ O))

*3. Within a range of URV \geq 0 and LRV \geq 0.

*4. Reference accuracy at calibrated condition.

MODEL SELECTION**Model GTX35R (Remote-sealed type for standard differential pressure)****Model GTX40R (Remote-sealed type for high differential pressure)****Flush 3 inches flange type for regular/high temperature/oxygen/chlorine service**

Model No.: GTX_ _R - Selection I (I II III IV V VI VII VIII IX) - Selection II (I II III IV V VI) - Option

Basic Model No.

Measuring span	2.5 to 100 kPa (250 to 10,160 mmH ₂ O)	GTX35R	Flush flange type 3 inches (80 mm)
	35 to 700 kPa (0.35 to 7 kgf/cm ²)	GTX40R	

Selection I

I	Output	4 to 20 mA (SFN Communication)	A	
		4 to 20 mA (HART5 Communication)	B	
		FOUNDATION Fieldbus communication	C	
		Digital output (DE communication) *3	D	
		4 to 20 mA (HART7 Communication)	F	
II	Fill fluid	Regular type (Silicone oil)	A	
		For high temperature service (Silicone oil)	B	
		For oxygen service (Fluorine oil)	H	
		For chlorine service (Fluorine oil) *2	J	
III	Wetted parts material	316 SST (Diaphragm: 316L SST)	A	
		ASTM B575 (Equivalent to Hastelloy C-276)	B	
		Tantalum *1	C	
		316L SST	D	
IV	Flange rating	ANSI150	A1	
		ANSI300	A2	
		ANSI600	A3	
		JIS10K	J1	
		JIS20K	J3	
		JIS30K	J4	
		JIS63K	J6	
		JPI150	P1	
		JPI300	P2	
		JPI600	P3	
V	Flange size	3 in./80 A	F	
VI	Flange type	Flush type	A	
VII	Flange material/bolt and nut material	Flange	Bolt and nut	
		304 SST	304 SST	A
		304 SST	630 SST	C
		304 SST	Carbon steel	D
		316 SST	304 SST	E
		316 SST	630 SST	G
		316 SST	Carbon steel	H
		316L SST	304 SST	J
		316L SST	630 SST	L
316L SST	Carbon steel	M		
VIII	Gasket face finish	None, Standard JISRa3.2 (12.5S)	A	
IX	Capillary length	2 m	02	
		3 m	03	
		4 m	04	
		5 m	05	
		6 m	06	
		7 m	07	
		8 m	08	
		9 m	09	
		10 m	10	
		2 m (with Olefin Cover)	A2	
		3 m (with Olefin Cover)	A3	
		4 m (with Olefin Cover)	A4	
		5 m (with Olefin Cover)	A5	
		6 m (with Olefin Cover)	A6	
		7 m (with Olefin Cover)	A7	
8 m (with Olefin Cover)	A8			
9 m (with Olefin Cover)	A9			
10 m (with Olefin Cover)	A0			

*1. In case "Tantalum" is used for diaphragm material and in case of "For high-temperature service", normal operating temperature of wetted parts is -10 to +180 deg.C

*2. In case code J is selected, code C "Tantalum" of Wetted parts material should be selected.

*3. Not applicable for the combination with code A2 "With external Zero/Span adjustment", Q1 "Safety Transmitter", and Q2 "NAMUR NE43 Compliant Output signal limits" of Option.

Model GTX35R (Remote-sealed type for standard differential pressure)
Model GTX40R (Remote-sealed type for high differential pressure)

Extended 4 inches flange type for regular/high temperature/oxygen/chlorine service

Model No.: GTX__R - Selection I (I II III IV V VI VII VIII IX) - Selection II (I II III IV V VI) - Option

Basic Model No.

Measuring span	2.5 to 100 kPa (250 to 10,160 mmH ₂ O)	GTX35R	Extended flange type 4 inches (100 mm)
	35 to 700 kPa (0.35 to 7 kgf/cm ²)	GTX40R	

Selection I

I	Output	4 to 20 mA (SFN Communication)	A	
		4 to 20 mA (HART5 Communication)	B	
		FOUNDATION Fieldbus communication	C	
		Digital output (DE communication) *2	D	
		4 to 20 mA (HART7 Communication)	F	
II	Fill fluid	Regular type (Silicone oil)	A	
		For high temperature service (Silicone oil) *1	B	
		For oxygen service (Fluorine oil)	H	
III	Wetted parts material	316 SST (Diaphragm: 316L SST)	A	
		316L SST *3 *4	D	
IV	Flange rating	ANSI150	A1	
		ANSI300 *1	A2	
		JIS10K	J1	
		JIS20K	J3	
		JIS30K *3 *4	J4	
		JPI150	P1	
		JPI300 *1	P2	
V	Flange size	4 in./100 A	G	
VI	Flange type	Extended Length 50 mm	B	
		Extended Length 100 mm	C	
		Extended Length 150 mm *4	D	
		Extended Length 200 mm *4	E	
		Extended Length 250 mm *1 *4	F	
		Extended Length 300 mm *1 *4	G	
VII	Flange material/bolt and nut material	Flange	Bolt and nut	
		304 SST	304 SST	A
		304 SST	630 SST	C
		304 SST	Carbon steel	D
		316 SST	304 SST	E
		316 SST	630 SST	G
		316 SST	Carbon steel	H
		316L SST	304 SST	J
		316L SST	630 SST	L
316L SST	Carbon steel	M		
VIII	Gasket face finish	None, Standard JISRA3.2 (12.5S)	A	
IX	Capillary length	2 m	02	
		3 m	03	
		4 m	04	
		5 m	05	
		6 m	06	
		7 m	07	
		8 m	08	
		9 m	09	
		10 m	10	
		2 m (with Olefin Cover)	A2	
		3 m (with Olefin Cover)	A3	
		4 m (with Olefin Cover)	A4	
		5 m (with Olefin Cover)	A5	
		6 m (with Olefin Cover)	A6	
		7 m (with Olefin Cover)	A7	
		8 m (with Olefin Cover)	A8	
		9 m (with Olefin Cover)	A9	
		10 m (with Olefin Cover)	A0	

*1. In case Fill Fluid: For high-temperature service and Flange Rating: ANSI300 and Wetted Parts material: 316L SST, Extended length of flange 250/300 mm are not available.

*2. Not applicable for the combination with code A2 “With external Zero/Span adjustment”, Q1 “Safety Transmitter”, and Q2 “NAMUR NE43 Compliant Output signal limits” of Option.

*3. In case Fill Fluid: For high-temperature service, not applicable for the combination with wetted parts material “316L” and Flange Type “JIS30K”.

*4. In case Fill Fluid: Regular type or for oxygen service and Flange rating: JIS30K and wetted parts material: 316L SST, Extension length of Flange 150/200/250/300 mm are not available.

Model GTX35R (Remote-sealed type for standard differential pressure)
Model GTX40R (Remote-sealed type for high differential pressure)

Flush 2 inches, 1 1/2 inches flange type for regular/high temperature/oxygen/chlorine service

Model No.: GTX_ _R - Selection I (I II III IV V VI VII VIII IX) - Selection II (I II III IV V VI) - Option

Basic Model No.

Measuring span	2.5 to 100 kPa (250 to 10,160 mmH ₂ O)	GTX35R	Flush flange type 2 inches (50 mm), 1 1/2 inches (40 mm)
	35 to 700 kPa (0.35 to 7 kgf/cm ²)	GTX40R	

Selection I

I	Output	4 to 20 mA (SFN Communication)	A	
		4 to 20 mA (HART5 Communication)	B	
		FOUNDATION Fieldbus communication	C	
		Digital output (DE communication) *5	D	
		4 to 20 mA (HART7 Communication)	F	
II	Fill fluid	Regular type (Silicone oil)	A	
		For high temperature service (Silicone oil)	B	
		For oxygen service (Fluorine oil)	H	
		For chlorine service (Fluorine oil) *4	J	
III	Wetted parts material	316 SST (Diaphragm: 316L SST)	A	
		ASTM B575 (Equivalent to Hastelloy C-276)	B	
		Tantalum *1 *2	C	
		316L SST	D	
IV	Flange rating	ANSI150	A1	
		ANSI300	A2	
		ANSI600	A3	
		JIS10K	J1	
		JIS20K	J3	
		JIS30K	J4	
		JIS63K	J6	
		JPI150	P1	
		JPI300	P2	
		JPI600	P3	
V	Flange size	1 1/2 in./40 A	D	
		2 in./50 A	E	
VI	Flange type	Flush type	A	
VII	Flange material/bolt and nut material	Flange	Bolt and nut	
		304 SST	304 SST	A
		304 SST	630 SST	C
		304 SST	Carbon steel	D
		316 SST	304 SST	E
		316 SST	630 SST	G
		316 SST	Carbon steel	H
		316L SST	304 SST	J
		316L SST	630 SST	L
316L SST	Carbon steel	M		
VIII	Gasket face finish	None, Standard JISRa3.2 (12.5S)	A	
IX	Capillary length	2 m	02	
		3 m	03	
		4 m *3	04	
		5 m *3	05	
		2 m (with Olefin Cover)	A2	
		3 m (with Olefin Cover)	A3	
		4 m (with Olefin Cover) *3	A4	
5 m (with Olefin Cover) *3	A5			

*1. In case "Tantalum" is used for diaphragm material and in case of "For high-temperature service", normal operating temperature of wetted parts is -10 to +180 deg.C.

*2. In case: Basic Model is GTX35R, and Tantalum is used for diaphragm material and Flange size is "Flush Diaphragm 1 1/2 in./40 mm", minimum Span will be 10 kPa.

*3. Specifications for Capillary Length 4 m and 5 m are as follows;

a. Temperature effect and Static pressure effect will be 1.5 times of those of High-temperature service.

b. Ambient temperature range for Regular service: -10 to +55 deg.C, Temperature of wetted parts: -30 to +110 deg.C.

c. Ambient temperature range for Oxygen service: -10 to +55 deg.C, Temperature of wetted parts: -10 to +110 deg.C.

d. In the case, Ambient temperature is 40 deg.C, the highest wetted parts temperature for High-temp service (4 m) will be 280 deg.C.

e. In the case, Ambient temperature is 38 deg.C, the highest wetted parts temperature for High-temp service (5 m) will be 280 deg.C.

*4. In case code J is selected, code C "Tantalum" of Wetted parts material should be selected.

*5. Not applicable for the combination with code A2 "With external Zero/Span adjustment", Q1 "Safety Transmitter", and Q2 "NAMUR NE43 Compliant Output signal limits" of Option.

Model GTX35R (Remote-sealed type for standard differential pressure)
Model GTX40R (Remote-sealed type for high differential pressure)

Extended 3 inches, 2 inches flange type for regular/high temperature/oxygen/chlorine service

Model No.: GTX__R - Selection I (I II III IV V VI VII VIII IX) - Selection II (I II III IV V VI) - Option

Basic Model No.

Measuring span	2.5 to 100 kPa (250 to 10,160 mmH ₂ O)	GTX35R	Extended flange type 3 inches (80 mm), 2 inches (50 mm)
	35 to 700 kPa (0.35 to 7 kgf/cm ²)	GTX40R	

Selection I

I	Output	4 to 20 mA (SFN Communication)	A	
		4 to 20 mA (HART5 Communication)	B	
		FOUNDATION Fieldbus communication	C	
		Digital output (DE communication) *4	D	
		4 to 20 mA (HART7 Communication)	F	
II	Fill fluid	Regular type (Silicone oil)	A	
		For high temperature service (Silicone oil)	B	
		For oxygen service (Fluorine oil)	H	
III	Wetted parts material	316 SST (Diaphragm: 316L SST)	A	
		316L SST	D	
IV	Flange rating	ANSI150	A1	
		ANSI300	A2	
		JIS10K	J1	
		JIS20K	J3	
		JIS30K	J4	
		JPI150	P1	
		JPI300	P2	
V	Flange size	2 in./50 A	E	
		3 in./80 A	F	
VI	Flange type	Extended Length 50 mm	B	
		Extended Length 100 mm	C	
		Extended Length 150 mm	D	
		Extended Length 200 mm *3	E	
		Extended Length 250 mm *3	F	
VII	Flange material/bolt and nut material	Flange	Bolt and nut	
		304 SST	304 SST	A
		304 SST	630 SST	C
		304 SST	Carbon steel	D
		316 SST	304 SST	E
		316 SST	630 SST	G
		316 SST	Carbon steel	H
		316L SST	304 SST	J
		316L SST	630 SST	L
316L SST	Carbon steel	M		
VIII	Gasket face finish	None, Standard JISRa3.2 (12.5S)	A	
IX	Capillary length	2 m	02	
		3 m	03	
		4 m	04	
		5 m	05	
		2 m (with Olefin Cover)	A2	
		3 m (with Olefin Cover)	A3	
		4 m (with Olefin Cover) *1	A4	
5 m (with Olefin Cover) *1	A5			

*1. Specifications for Capillary Length 4 m and 5 m are as follows;

- a. Temperature characteristics and Static pressure effect will be 1.5 times of those of High-temperature service.
- b. Ambient temperature range for Regular service: -10 to +55 deg.C, Temperature of wetted parts: -30 to +110 deg.C.
- c. Ambient temperature range for Oxygen service: -10 to +55 deg.C, Temperature of wetted parts: -10 to +110 deg.C.
- d. In the case, Ambient temperature is 40 deg.C, the highest wetted parts temperature for High-temp service (4 m) will be 280 deg.C.
- e. In the case, Ambient temperature is 38 deg.C, the highest wetted parts temperature for High-temp service (5 m) will be 280 deg.C.

*3. In case Fill Fluid: For high-temperature service and Wetted Parts material: 316L SST, Extension length of Flange 200/250/300 mm are not available.

*4. Not applicable for the combination with code A2 "With external Zero/Span adjustment", Q1 "Safety Transmitter", and Q2 "NAMUR NE43 Compliant Output signal limits" of Option.

Model GTX35R (Remote-sealed type for standard differential pressure)
Model GTX40R (Remote-sealed type for high differential pressure)

Combination extended 4 inches: flush 3 in. flange type for regular/high temperature/oxygen service

Model No.: GTX_ _R - Selection I (I II III IV V VI VII VIII IX) - Selection II (I II III IV V VI) - Option

Basic Model No.

Measuring span	2.5 to 100 kPa (250 to 10,160 mmH ₂ O)	GTX35R	Combination: 3 in. flush: 4 in. extended flange
	35 to 700 kPa (0.35 to 7 kgf/cm ²)	GTX40R	

Selection I

I	Output	4 to 20 mA (SFN Communication)	A	
		4 to 20 mA (HART5 Communication)	B	
		FOUNDATION Fieldbus communication	C	
		Digital output (DE communication) *3	D	
		4 to 20 mA (HART7 Communication)	F	
II	Fill fluid	Regular type (Silicone oil) *4	A	
		For high temperature service (Silicone oil) *1 *4	B	
		For oxygen service (Fluorine oil) *5	H	
III	Wetted parts material	316 SST (Diaphragm: 316L SST)	A	
		316L SST *1 *4 *5	D	
IV	Flange rating	ANSI150	A1	
		ANSI300 *1	A2	
		JIS10K	J1	
		JIS20K	J3	
		JIS30K *4 *5	J4	
		JPI150	P1	
		JPI300 *1	P2	
V	Flange size	Combination 3" flush:4" extended flange	R	
VI	Flange type	Extended Length 50 mm	B	
		Extended Length 100 mm	C	
		Extended Length 150 mm *5	D	
		Extended Length 200 mm *5	E	
		Extended Length 250 mm *1 *5	F	
		Extended Length 300 mm *1 *5	G	
VII	Flange material/bolt and nut material	Flange	Bolt and nut	
		304 SST	304 SST	A
		304 SST	630 SST	C
		304 SST	Carbon steel	D
		316 SST	304 SST	E
		316 SST	630 SST	G
		316 SST	Carbon steel	H
		316L SST	304 SST	J
		316L SST	630 SST	L
		316L SST	Carbon steel	M
VIII	Gasket face finish	None, Standard JISRa3.2 (12.5S)	A	
IX	Capillary length	2 m	02	
		3 m	03	
		4 m	04	
		5 m	05	
		6 m	06	
		7 m	07	
		8 m	08	
		9 m	09	
		10 m	10	
		2 m (with Olefin Cover)	A2	
		3 m (with Olefin Cover)	A3	
		4 m (with Olefin Cover)	A4	
		5 m (with Olefin Cover)	A5	
		6 m (with Olefin Cover)	A6	
		7 m (with Olefin Cover)	A7	
		8 m (with Olefin Cover)	A8	
9 m (with Olefin Cover)	A9			
10 m (with Olefin Cover)	A0			

*1. In case Fill Fluid: For high-temperature service and Flange Rating: ANSI/JPI300 and Wetted Parts material: 316L SST, Extended length of flange 250/300 mm are not available.

*2. Not applicable for "For high temperature service", code B of Fill Fluid.

*3. Not applicable for the combination with code A2 "With external Zero/Span adjustment", Q1 "Safety Transmitter", and Q2 "NAMUR NE43 Compliant Output signal limits" of Option.

*4. In case Fill Fluid: For high-temperature service, not applicable for the combination with wetted parts material "316L" and Flange Type "JIS30K".

*5. In case Fill Fluid: Regular type or for oxygen service and Flange rating: JIS30K and wetted parts material: 316L SST, Extension length of Flange 150/200/250/300 mm are not available.

Model GTX35R (Remote-sealed type for standard differential pressure)
Model GTX40R (Remote-sealed type for high differential pressure)

Combination extended 3 inches: flush 2 in. flange type for regular/high temperature/oxygen service

Model No.: GTX__R - Selection I (I II III IV V VI VII VIII IX) - Selection II (I II III IV V VI) - Option

Basic Model No.

Measuring span	2.5 to 100 kPa (250 to 10,160 mmH ₂ O)	GTX35R	Combination 2 in. flush and 3 in. extended flange
	35 to 700 kPa (0.35 to 7 kgf/cm ²)	GTX40R	

Selection I

I	Output	4 to 20 mA (SFN Communication)	A	
		4 to 20 mA (HART5 Communication)	B	
		FOUNDATION Fieldbus communication	C	
		Digital output (DE communication) *1	D	
		4 to 20 mA (HART7 Communication)	F	
		II	Fill fluid	Regular type (Silicone oil)
		For high temperature service (Silicone oil)	B	
		For oxygen service (Fluorine oil)	H	
III	Wetted parts material	316 SST (Diaphragm: 316L SST)	A	
		316L SST	D	
IV	Flange rating	ANSI150	A1	
		ANSI300	A2	
		JIS10K	J1	
		JIS20K	J3	
		JIS30K	J4	
		JPI150	P1	
		JPI300	P2	
V	Flange size	Combination 2 in. flush and 3 in. extended flange	P	
VI	Flange type	Extended Length 50 mm	B	
		Extended Length 100 mm	C	
		Extended Length 150 mm	D	
		Extended Length 200 mm	E	
		Extended Length 250 mm	F	
		Extended Length 300 mm	G	
VII	Flange material/bolt and nut material	Flange	Bolt and nut	
		304 SST	304 SST	A
		304 SST	630 SST	C
		304 SST	Carbon steel	D
		316 SST	304 SST	E
		316 SST	630 SST	G
		316 SST	Carbon steel	H
		316L SST	304 SST	J
		316L SST	630 SST	L
		316L SST	Carbon steel	M
VIII	Gasket face finish	None, Standard JISRa3.2 (12.5S)	A	
IX	Capillary length	2 m	02	
		3 m	03	
		4 m	04	
		5 m	05	
		2 m (with Olefin Cover)	A2	
		3 m (with Olefin Cover)	A3	
		4 m (with Olefin Cover)	A4	
		5 m (with Olefin Cover)	A5	

*1. Not applicable for the combination with code A2 "With external Zero/Span adjustment", Q1 "Safety Transmitter", and Q2 "NAMUR NE43 Compliant Output signal limits" of Option.

**Model GTX35R (Remote-sealed type for standard
Model GTX40R (Remote-sealed type for high differential pressure)**

Flush 3 inches flange type for high temperature vacuum, high temperature high vacuum service

Model No.: GTX_ _R - Selection I (I II III IV V VI VII VIII IX) - Selection II (I II III IV V VI) - Option

Basic Model No.

Measuring span	2.5 to 100 kPa (250 to 10,160 mmH ₂ O)	GTX35R	Flush flange type 3 inches (80 mm)
	35 to 700 kPa (0.35 to 7 kgf/cm ²)	GTX40R	

Selection I

I	Output	4 to 20 mA (SFN Communication)	A	
		4 to 20 mA (HART5 Communication)	B	
		FOUNDATION Fieldbus communication	C	
		Digital output (DE communication) *2	D	
		4 to 20 mA (HART7 Communication)	F	
II	Fill fluid	For high temperature vacuum service (Silicone oil)	C	
		For high temperature high vacuum service (Silicone oil)	D	
III	Wetted parts material	ASTM B575 (Equivalent to Hastelloy C-276)	B	
		Tantalum *1	C	
		316L SST	D	
IV	Flange rating	ANSI150	A1	
		ANSI300	A2	
		ANSI600	A3	
		JIS10K	J1	
		JIS20K	J3	
		JIS30K	J4	
		JIS63K	J6	
		JPI150	P1	
		JPI300	P2	
		JPI600	P3	
V	Flange size	3 in./80 A	F	
VI	Flange type	Flush type	A	
VII	Flange material/bolt and nut material	Flange	Bolt and nut	
		304 SST	304 SST	A
		304 SST	630 SST	C
		304 SST	Carbon steel	D
		316 SST	304 SST	E
		316 SST	630 SST	G
		316 SST	Carbon steel	H
		316L SST	304 SST	J
		316L SST	630 SST	L
316L SST	Carbon steel	M		
VIII	Gasket face finish	None, Standard JISRa3.2 (12.5S)	A	
IX	Capillary length	2 m	02	
		3 m	03	
		4 m	04	
		5 m	05	
		6 m	06	
		7 m	07	
		8 m	08	
		9 m	09	
	10 m	10		

*1. In case "Tantalum" is used for diaphragm material, and in case of "For high-temperature service", normal operating temperature of wetted parts is -10 to +180 deg.C.

*2. Not applicable for the combination with code A2 "With external Zero/Span adjustment", Q1 "Safety Transmitter", and Q2 "NAMUR NE43 Compliant Output signal limits" of Option.

Model GTX35R (Remote-sealed type for standard differential pressure)
Model GTX40R (Remote-sealed type for high differential pressure)

Extended 4 inches flange type for high temperature vacuum, high temperature high vacuum service

Model No.: GTX__R - Selection I (I II III IV V VI VII VIII IX) - Selection II (I II III IV V VI) - Option

Basic Model No.

Measuring span	2.5 to 100 kPa (250 to 10,160 mmH ₂ O)	GTX35R	Extended flange type 4 inches (100 mm)
	35 to 700 kPa (0.35 to 7 kgf/cm ²)	GTX40R	

Selection I

I	Output	4 to 20 mA (SFN Communication)	A	
		4 to 20 mA (HART5 Communication)	B	
		FOUNDATION Fieldbus communication	C	
		Digital output (DE communication) *2	D	
		4 to 20 mA (HART7 Communication)	F	
II	Fill fluid	For high temperature vacuum service (Silicone oil)	C	
		For high temperature high vacuum service (Silicone oil)	D	
III	Wetted parts material	316 SST (Diaphragm: 316L SST)	A	
		316L SST *1 *3	D	
IV	Flange rating	ANSI150	A1	
		ANSI300 *1	A2	
		JIS10K	J1	
		JIS20K	J3	
		JIS30K *3	J4	
		JPI150	P1	
V	Flange size	JPI300 *1	P2	
		4 in./100 A	G	
VI	Flange type	Extended Length 50 mm	B	
		Extended Length 100 mm	C	
		Extended Length 150 mm	D	
		Extended Length 200 mm *1	E	
		Extended Length 250 mm *1	F	
VII	Flange material/bolt and nut material	Extended Length 300 mm *1	G	
		Flange	Bolt and nut	
		304 SST	304 SST	A
		304 SST	630 SST	C
		304 SST	Carbon steel	D
		316 SST	304 SST	E
		316 SST	630 SST	G
		316 SST	Carbon steel	H
		316L SST	304 SST	J
316L SST	630 SST	L		
VIII	Gasket face finish	316L SST	M	
		None, Standard JISRa3.2 (12.5S)	A	
IX	Capillary length	2 m	02	
		3 m	03	
		4 m	04	
		5 m	05	
		6 m	06	
		7 m	07	
		8 m	08	
		9 m	09	
		10 m	10	

*1. In case "ANSI/JPI300" is used for Flange Rating and "316L SST" is used for wetted parts material, not available for Extended length 200/250/300 mm.

*2. Not applicable for the combination with code A2 "With external Zero/Span adjustment", Q1 "Safety Transmitter", and Q2 "NAMUR NE43 Compliant Output signal limits" of Option.

*3. Not applicable for the combination with wetted parts material "316L SST" and Flange rating "JIS30K".

Model GTX35R (Remote-sealed type for standard differential pressure)
Model GTX40R (Remote-sealed type for high differential pressure)

Flush 2 inches, 1 1/2 inches flange type for high temperature vacuum, high temperature high vacuum service

Model No.: GTX_ _R - Selection I (I II III IV V VI VII VIII IX) - Selection II (I II III IV V VI) - Option

Basic Model No.

Measuring span	2.5 to 100 kPa (250 to 10,160 mmH ₂ O)	GTX35R	Flush flange type 2 inches (50 mm), 1 1/2 inches (40 mm)
	35 to 700 kPa (0.35 to 7 kgf/cm ²)	GTX40R	

Selection I

I	Output	4 to 20 mA (SFN Communication)	A	
		4 to 20 mA (HART5 Communication)	B	
		FOUNDATION Fieldbus communication	C	
		Digital output(DE communication) *2	D	
		4 to 20 mA (HART7 Communication)	F	
II	Fill fluid	For high temperature vacuum service (Silicone oil)	C	
		For high temperature high vacuum service (Silicone oil)	D	
III	Wetted parts material	ASTM B575 (Equivalent to Hastelloy C-276)	B	
		Tantalum *1	C	
		316L SST	D	
IV	Flange rating	ANSI150	A1	
		ANSI300	A2	
		ANSI600	A3	
		JIS10K	J1	
		JIS20K	J3	
		JIS30K	J4	
		JIS63K	J6	
		JPI150	P1	
		JPI300	P2	
		JPI600	P3	
V	Flange size	1 1/2 in./40 A	D	
		2 in./50 A	E	
VI	Flange type	Flush type	A	
VII	Flange material/bolt and nut material	Flange	Bolt and nut	
		304 SST	304 SST	A
		304 SST	630 SST	C
		304 SST	Carbon steel	D
		316 SST	304 SST	E
		316 SST	630 SST	G
		316 SST	Carbon steel	H
		316L SST	304 SST	J
		316L SST	630 SST	L
316L SST	Carbon steel	M		
VIII	Gasket face finish	None, Standard JISRa3.2 (12.5S)	A	
IX	Capillary length	2 m	02	
		3 m	03	
		4 m	04	
		5 m	05	

*1. In case "Tantalum" is used for diaphragm material and in case of "For high-temperature service", normal operating temperature of wetted parts is -10 to +180 deg.C

*2. Not applicable for the combination with code A2 "With external Zero/Span adjustment", Q1 "Safety Transmitter", and Q2 "NAMUR NE43 Compliant Output signal limits" of Option.

Model GTX35R (Remote-sealed type for standard differential pressure)
Model GTX40R (Remote-sealed type for high differential pressure)

Extended 3 inches, 2 inches flange type for high temperature vacuum, high temperature high vacuum service

Model No.: GTX_ _R - Selection I (I II III IV V VI VII VIII IX) - Selection II (I II III IV V VI) - Option

Basic Model No.

Measuring span	2.5 to 100 kPa (250 to 10,160 mmH ₂ O)	GTX35R	Extended flange type 3 inches (80 mm), 2 inches (50 mm)
	35 to 700 kPa (0.35 to 7 kgf/cm ²)	GTX40R	

Selection I

I	Output	4 to 20 mA (SFN Communication)	A	
		4 to 20 mA (HART5 Communication)	B	
		FOUNDATION Fieldbus communication	C	
		Digital output (DE communication) *1	D	
		4 to 20 mA (HART7 Communication)	F	
II	Fill fluid	For high temperature vacuum service (Silicone oil)	C	
		For high temperature high vacuum service (Silicone oil)	D	
III	Wetted parts material	316 SST (Diaphragm: 316L SST)	A	
		316L SST	D	
IV	Flange rating	ANSI150	A1	
		ANSI300	A2	
		JIS10K	J1	
		JIS20K	J3	
		JIS30K	J4	
		JPI150	P1	
		JPI300	P2	
V	Flange size	2 in./50 A	E	
		3 in./80 A	F	
VI	Flange type	Extended Length 50 mm	B	
		Extended Length 100 mm	C	
		Extended Length 150 mm	D	
VII	Flange material/bolt and nut material	Flange	Bolt and nut	
		304 SST	304 SST	A
		304 SST	630 SST	C
		304 SST	Carbon steel	D
		316 SST	304 SST	E
		316 SST	630 SST	G
		316 SST	Carbon steel	H
		316L SST	304 SST	J
		316L SST	630 SST	L
316L SST	Carbon steel	M		
VIII	Gasket face finish	None, Standard JISRa3.2 (12.5S)	A	
IX	Capillary length	2 m	02	
		3 m	03	
		4 m	04	
		5 m	05	

*1. Not applicable for the combination with code A2 "With external Zero/Span adjustment", Q1 "Safety Transmitter", and Q2 "NAMUR NE43 Compliant Output signal limits" of Option.

Model GTX35R (Remote-sealed type for standard differential pressure)
Model GTX40R (Remote-sealed type for high differential pressure)

Flush 3/4 inches, 1/2 inches flange type for regular/high temperature/oxygen/chlorine service

Model No.: GTX_ _R - Selection I (I II III IV V VI VII VIII IX) - Selection II (I II III IV V VI) - Option

Basic Model No.

Measuring span	2.5 to 100 kPa (250 to 10,160 mmH ₂ O)	GTX35R	Flush flange type 3/4 inches (20 mm), 1/2 inches (15 mm)
	35 to 700 kPa (0.35 to 7 kgf/cm ²)	GTX40R	

Selection I

I	Output	4 to 20 mA (SFN Communication)	A	
		4 to 20 mA (HART5 Communication)	B	
		FOUNDATION Fieldbus communication	C	
		Digital output (DE communication) *7	D	
		4 to 20 mA (HART7 Communication)	F	
II	Fill fluid	Regular type (Silicone oil)	A	
		For high temperature service (Silicone oil)	B	
		For oxygen service (Fluorine oil)	H	
III	Wetted parts material	316 SST (Diaphragm:316L SST)	A	
		ASTM B575 (Equivalent to Hastelloy C-276) *5	B	
		316L SST *6	D	
IV	Flange rating	No flange	XX	
V	Flange size	For small size flange	X	
VI	Flange type	For small flange type with adapter, rear connection to capillary *1	1	
		For small flange type with no adapter, rear connection to capillary	3	
		For small flange type, corrosion resistant model with adapter, rear connection to capillary *1 *2 *3	5	
		For small flange type, high model with adapter, rear connection to capillary *1 *2 *4	6	
VII	Flange material/bolt and nut material	Flange	Bolt and nut	
		No flange	304 SST	1
		No flange	630 SST	3
		No flange	Carbon steel	4
VIII	Gasket face finish	None, Standard JISR3.2 (12.5S)	A	
IX	Capillary length	2 m	02	
		3 m	03	
		4 m	04	
		5 m	05	
		2 m (with Olefin Cover)	A2	
		3 m (with Olefin Cover)	A3	
		4 m (with Olefin Cover)	A4	
5 m (with Olefin Cover)	A5			

*1. Small flange mounting kit model (HF-) should be selected.

*2. The combination with model: SDR (Elliptical Tube Flowmeter) is not available.

*3. In case code 5 is selected, wetted parts material 316 SST or ASTM B575 should be selected.

*4. In case code 6 is selected, wetted parts material 316 SST should be selected.

*5. Not applicable for code 6 of Flange type.

*6. Not applicable for code 5 and 6 of Flange type.

*7. Not applicable for the combination with code A2 "With external Zero/Span adjustment", Q1 "Safety Transmitter", and Q2 "NAMUR NE43 Compliant Output signal limits" of Option.

Model GTX35R (Remote-sealed type for standard differential pressure)

Flush 3/4 inches, 1/2 inches flange type for low temperature/fast response service Silicone oil

Model No.: GTX__R - Selection I (I II III IV V VI VII VIII IX) - Selection II (I II III IV V VI) - Option

Basic Model No.

Measuring span	2.5 to 100 kPa (250 to 10,160 mmH ₂ O)	GTX35R	Flush flange type 3/4 inches (20 mm), 1/2 inches (15 mm)
----------------	---	--------	--

Selection I

I	Output	4 to 20 mA (SFN Communication)	A	
		4 to 20 mA (HART5 Communication)	B	
		FOUNDATION Fieldbus communication	C	
		Digital output (DE communication) *1	D	
		4 to 20 mA (HART7 Communication)	F	
II	Fill fluid	For low temperature/Fast response service	F	
III	Wetted parts material	316 SST (Diaphragm: 316L SST)	A	
IV	Flange rating	No flange	XX	
V	Flange size	For small size flange model	X	
VI	Flange type	For small flange type with adapter, rear connection to capillary *2	1	
		For small flange type with no adapter, rear connection to capillary	3	
VII	Flange material/bolt and nut material	Flange	Bolt and nut	
		No flange	304 SST	1
		No flange	630 SST	3
		No flange	Carbon steel	4
VIII	Gasket face finish	None, Standard JISRa3.2 (12.5S)	A	
IX	Capillary length	2 m	02	
		3 m	03	
		4 m	04	
		5 m	05	
		2 m (with Olefin Cover)	A2	
		3 m (with Olefin Cover)	A3	
		4 m (with Olefin Cover)	A4	
		5 m (with Olefin Cover)	A5	

*1. Not applicable for the combination with code A2 “With external Zero/Span adjustment”, Q1 “Safety Transmitter”, and Q2 “NAMUR NE43 Compliant Output signal limits” of Option.

*2. Small flange mounting kit model (HF-) should be selected.

Model No.: GTX__R - Selection I (I II III IV V VI VII VIII IX) - Selection II (I II III IV V VI) - Option

Selection II

			—	
I	Electric connection	1/2 NPT, Watertight	A	
		M20, Watertight *3	B	
II	Explosion proof [★] *4	None		XX
		FM Explosionproof for Division system/Flameproof for Zone system		F1
		FM Intrinsic safety		F2
		FM Nonincendive		F5
		Combination of code F1, F2, and F5		F6
		ATEX Flameproof		A1
		ATEX Intrinsic safety		A2
		IECEX Flameproof		E1
		IECEX Intrinsic safety		E2
		NEPSI Flameproof		N1
		NEPSI Intrinsic safety		N2
		NEPSI Type n		N5
	KOSHA Flameproof *5		K1	
III	Built-in indicating smart meter	None		X
		With indicator	A	
IV	Paint *7	Standard		X
		None (316 stainless steel housing)		E
		Corrosion-proof (Urethane)		H
V	Failure alarm	UP Scale		A
		DOWN scale		B
		None (for FOUNDATION Fieldbus) *8		X
VI	Mounting Bracket	None		X
		304 SST (Flat Form)		6
		Direct mounting kit *9		D

*3. Not applicable for the combination with code F1, F6 of Explosion proof.

*4. For FOUNDATION Fieldbus type. Refer to SS2-GTX00Z-0100.

*5. Not applicable for the combination with code E of Paint.

*6. In case the code C “FOUNDATION Fieldbus communication” of output is selected, code A2 of Option code should be selected.

*7. In case code X or D is selected, the material of transmitter case is aluminum alloy.

*8. In case this code is selected, code C of Output should be selected.

*9. Not applicable for the combination with B, C, or D of Fill Fluid.

Model No.: GTX_ _R - Selection I (I II III IV V VI VII VIII IX) - Selection II (I II III IV V VI) - Option

Option

		—
No options		XX
With external Zero/Span adjustment (With external ZERO adjustment only for FOUNDATION Fieldbus)*8 *9		A2
One elbow (left) *3 *4 *7		G1
One elbow (right) *3 *4 *7		G2
2 elbows *3 *5 *7		G3
Oil and water free finish		K1
Oil free finish *1		K3
Au Plating Diaphragm		L1
316 SST (Parts in contact with atmosphere) *11 *12 *13		P8
Safety Transmitter *2 *9 *14		Q1
NAMUR NE43 Compliant Output Signal Limits: 3.8 to 20.5 mA (Output 21.6 mA/selected upper limit, 3.6 mA/selected lower limit) *9 *14		Q2
Alarm Output (contact output) *10 *14		Q7
Advanced diagnostics *15		Q8
Custom calibration		R1
Test report		T1
Mill certificate		T2
Traceability certificate		T4
NACE certificate *6		T5
Non SI Unit		W1

- *1. No need to select when Fill Fluid code H, or J is selected.
- *2. Not applicable for the combination with code A2, or Q7 of Option.
- *3. Not applicable for the combination with code A, or B of Process installation.
- *4. Not applicable for the combination with code F1, F6 of Explosion proof.
- *5. Not applicable for any Explosion proof. Please select code XX "None" of Explosion proof.
- *6. Applicable for "ASTM B575", code B of Material (center body).
- *7. Not applicable for the combination with code B "M20, Watertight" electrical connection.
- *8. Not applicable for the combination with code X "None" of Indicator. Please select "With indicator".
- *9. Not applicable for the combination with code D "Digital output (DE communication)" and F "4 to 20 mA (HART7 Communication)" of output.
- *10. Not applicable for the combination with code F2, F5, F6, N2, N5, E2, and A2 of Explosion proof.
- *11. In case code P8 is selected, code D of Bolt/nut should be selected.
- *12. In case code P8 is selected, code E of Paint should be selected.
- *13. In case code P8 is selected, code X or 2 of Mounting bracket should be selected.
- *14. Not applicable for the combination with code C "Digital output (FOUNDATION Fieldbus communication)" of output.
- *15. Not applicable for the combination with code A "4 to 20 mA (SFN Communication)", B "4 to 20 mA (HART5 Communication)", and D "Digital output (DE communication)" of output.

Small flange type mounting kit (Adapter flange)

			HF -	I	II	III	IV	V	-	VI	
I	Adapter flange quantity	For DP remote (2 pieces) *2 *5	E								
		For high performance DP remote (2 pieces) *4 *6 *7	W								
II	Flange size	1/2 in.		1							
		3/4 in.		2							
III	Flange rating	JIS10K				A					
		JIS20K				C					
		JIS30K				D					
		ANSI150				G					
		ANSI300 *3				H					
		JPI150				N					
		JPI300				P					
IV	Adapter material	SCS14A or 316 SST					2				
V	Bolt/nut material	304 SST						2			
		630 SST						3			
VI	Option	None								X	
		Oil and water finish *1								1	
		Oil free finish *1									2
		Long Vent/Drain Plug									3
		Assembled with transmitter									4

*1. When this option is selected, the same option for transmitter must be selected.

*2. 630 SST Bolt/nut material should be selected.

*3. Refer to the specification sheet for the working pressure range.

*4. The combination with Model: SDR is not available.

*5. Select this code when flange type code "1" is selected in the transmitter selection.

*6. Select this code when flange type code "5" or "6" is selected in the transmitter selection.

*7. 304 SST Bolt/nut material should be selected.

DIMENSION

Model GTX35R/GTX40R

Unit: mm

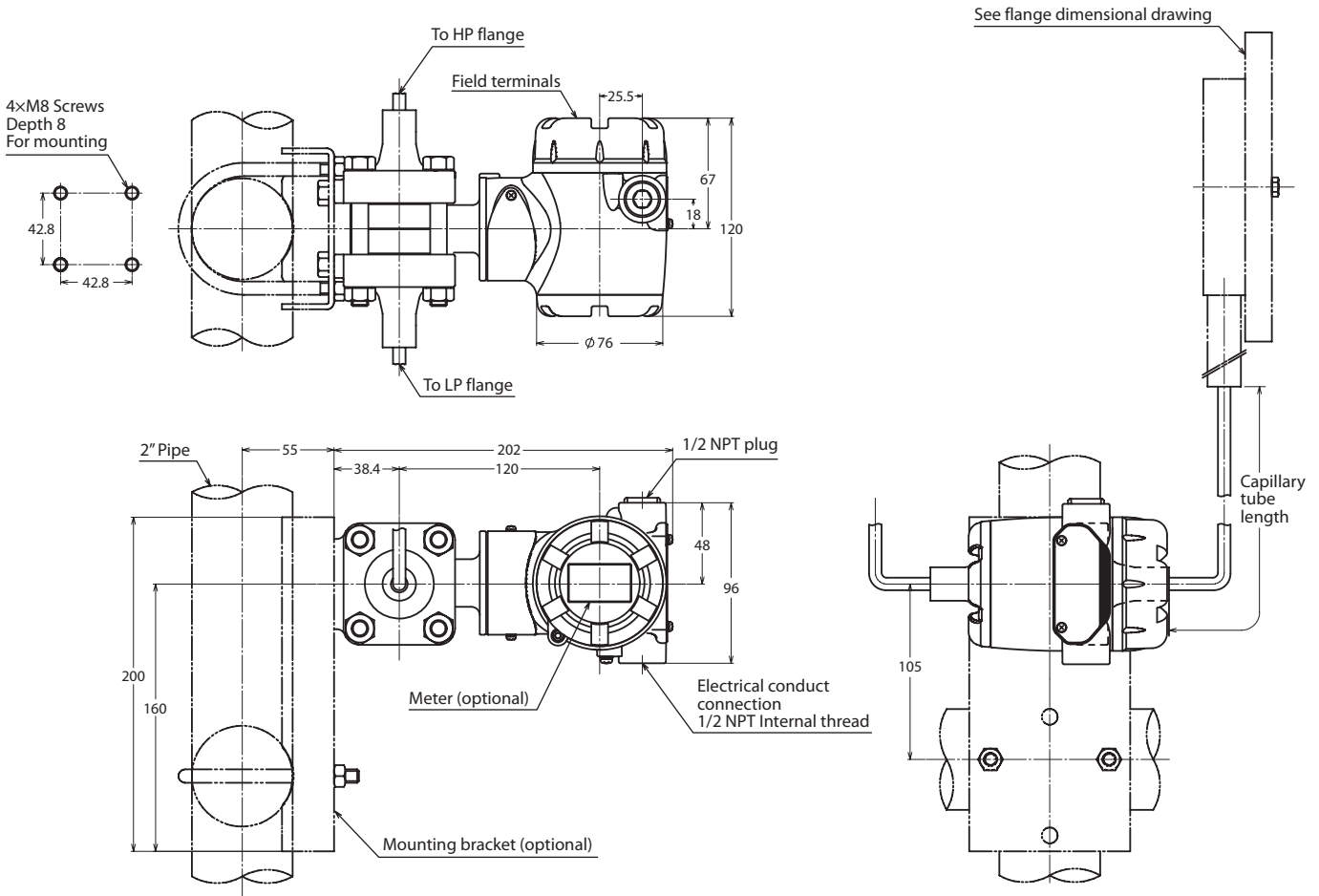

- Note) 1. To prevent vibration, you are recommended to fasten the capillary tube mid-length.
 2. Select a gasket that will not contact the diaphragm after it is tightened.
 3. When the suppression is larger than one half of the measuring span, the higher pressure side and the lower pressure side of the process connection end flange are opposite to those shown in the figure above. When using the transmitter to measure liquid levels, connect at H and L marks on the meter body as shown in the right figure.

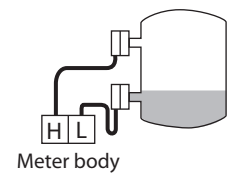

TERMINAL CONNECTION

(Not applicable for Fieldbus. See SS2-GTX00Z-0100 for Fieldbus.)

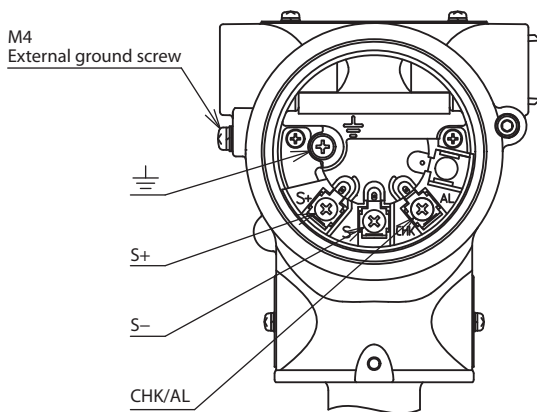

Table 1: Terminal connection

Symbol	Details
S+	Power supply and output signal +
S-	Power supply and output signal -/Check meter -
CHK/AL	Check meter +
⏏	Ground

Table 2: Terminal connection (option "Q7": Alarm output)

Symbol	Details
S+	Power supply and output signal +
S-	Power supply and output signal -
CHK/AL	Alarm +
⏏	Ground/Alarm -

Table of flush diaphragm flange dimensions

Unit: mm

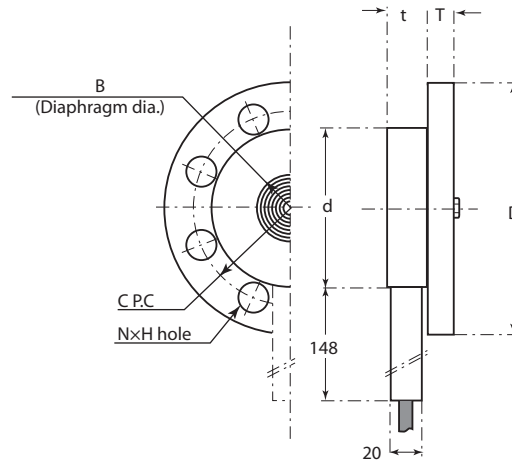

Rating	Flange rating	D	T	C	N	H	d
1 1/2 inch (40 mm)	JIS 10K-40 mm	140	16	105	4	19	81
	JIS 20K-40 mm	140	18	105	4	19	
	JIS 30K-40 mm	160	22	120	4	23	
	ANSI 150-1 1/2 inch	127	18	98.6	4	16	
	ANSI 300-1 1/2 inch	155	21	114.3	4	22	
	ANSI 600-1 1/2 inch	155	22.5	114.3	4	22	
	JPI 150-1 1/2 inch	127	18	98.6	4	16	
	JPI 300-1 1/2 inch	155	21	114.3	4	22	
2 inches (50 mm)	JIS 10K-50 mm	155	16	120	4	19	99
	JIS 20K-50 mm	155	18	120	8	19	
	JIS 30K-50 mm	165	22	130	8	19	
	ANSI 150-2 inches	152	19.5	120.6	4	19	
	ANSI 300-2 inches	165	22.5	127	8	19	
	ANSI 600-2 inches	165	25.5	127	8	19	
	JPI 150-2 inches	152	19.5	120.6	4	19	
	JPI 300-2 inches	165	22.5	127	8	19	
3 inches (80 mm)	JIS 10K-80 mm	185	18	150	8	19	129.5
	JIS 20K-80 mm	200	22	160	8	23	
	JIS 30K-80 mm	210	28	170	8	23	
	ANSI 150-3 inches	190	24	152.4	4	19	
	ANSI 300-3 inches	210	28.5	168.1	8	22	
	ANSI 600-3 inches	210	32	168.1	8	22	
	JPI 150-3 inches	190	24	152.4	4	19	
	JPI 300-3 inches	210	28.5	168.1	8	22	
JPI 600-3 inches	210	32	168.1	8	22		

Diaphragm Diameter

Selection Code			Description			φB	t
Flange size	Wetted Parts	Fill Fluid	Flange Size	Wetted Parts	Fill Fluid		
D	A,C,D	A,B,C D,H,J	1 1/2* (40A)	SUS316	***	43	25
				Tantalum			
	SUS316L						
B	A,B,H,J C,D	ASTM B575**	***	43	26.7		
E	A,C,D	A,B,C D,H,J	2* (50A)	SUS316	***	62	25
				Tantalum			
	SUS316L						
B	A,B,H,J C,D	ASTM B575**	***	43	26.7		
F	A,B,C,D	A,B,C D,H,J	3B (80A)	SUS316	***	95	25
				ASTM B575** Tantalum SUS316L			

** Hastelloy C-276 equivalent

*** Fill Fluid :

A: Regular type (Silicone oil)

B: High temperature service (Silicone oil)

C: High temperature vacuum service (Silicone oil)

D: High temperature high vacuum service (Silicone oil)

H: Oxygen service (Fluorine oil)

J: Chlorine service (Fluorine oil)

Table of extended diaphragm flange dimensions

Unit: mm

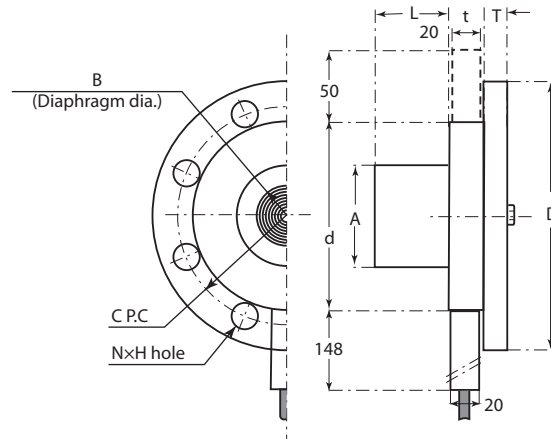

Rating	Flange rating	D	T	C	N	H	d	A	t	B	L
2 inches (50 mm)	JIS 10K - 50 mm	155	16	120	4	19	99	47±1	25	43	50
	JIS 20K - 50 mm	155	18	120	8	19					100
	JIS 30K - 50 mm	165	22	130	8	19					150
	ANSI 150 - 2 inches	152	19.5	120.6	4	19					200
	ANSI 300 - 2 inches	165	22.5	127	8	19					250
	ANSI 600 - 2 inches	165	25.5	127	8	19					300
	JPI 150 - 2 inches	152	19.5	120.6	4	19					
	JPI 300 - 2 inches	165	22.5	127	8	19					
3 inches (80 mm)	JIS 10K - 80 mm	185	18	150	8	19	129.5	69±1	25	62	
	JIS 20K - 80 mm	200	22	160	8	23					
	JIS 30K - 80 mm	210	28	170	8	23					
	ANSI 150 - 3 inches	190	24	152.4	4	19					
	ANSI 300 - 3 inches	210	28.5	168.1	8	22					
	ANSI 600 - 3 inches	210	32	168.1	8	22					
	JPI 150 - 3 inches	190	24	152.4	4	19					
	JPI 300 - 3 inches	210	28.5	168.1	8	22					
4 inches (100 mm)	JIS 10K - 100 mm	210	18	175	8	19	157	95±1	23	90.4	
	JIS 20K - 100 mm	225	24	185	8	23					
	JIS 30K - 100 mm	240	32	195	8	25					
	ANSI 150 - 4 inches	229	24	190.5	8	19					
	ANSI 300 - 4 inches	254	32	200.2	8	22					
	JPI 150 - 4 inches	229	24	190.5	8	19					
	JPI 300 - 4 inches	254	32	200.2	8	22					

Model GTX35R/40R

Unit: mm

1/2 or 3/4 inch flange adapter assembly drawing

Model HF - W _ _ _ _ - _

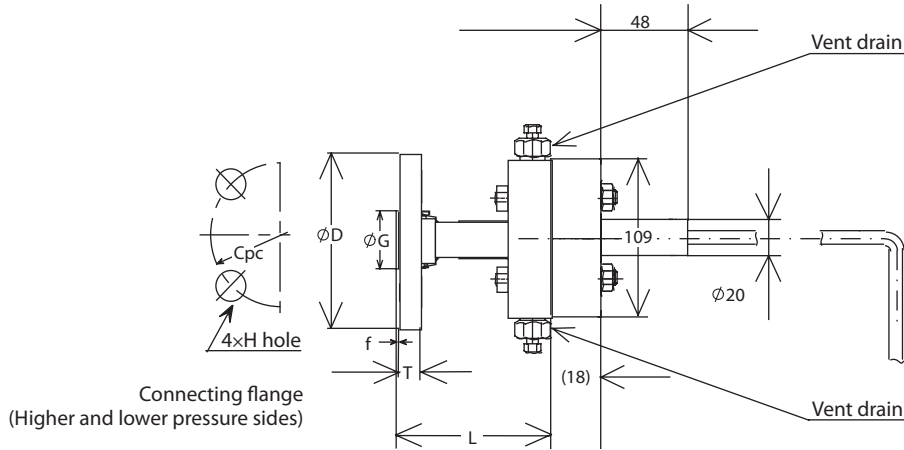

Table 4. Table of flange dimensions

Flange standard	φD	φG	T	f	C	H	L
JIS 10K - 15 mm (1/2 inch)	95	51	12	1	70	15	102
JIS 20K - 15 mm (1/2 inch)	95	51	14	1	70	15	102
JIS 30K - 15 mm (1/2 inch)	115	55	18	1	80	19	107
ANSI 150 - 15 mm (1/2 inch)	89	35.1	11.5	1.6	60.5	16	99
ANSI 300 - 15 mm (1/2 inch)	95	35.1	14.5	1.6	66.5	16	105
JPI 150 - 15 mm (1/2 inch)	89	35.1	11.5	1.6	60.5	16	99
JPI 300 - 15 mm (1/2 inch)	95	35.1	14.5	1.6	66.5	16	105
JIS 10K - 20 mm (3/4 inch)	100	56	14	1	75	15	103
JIS 20K - 20 mm (3/4 inch)	100	56	16	1	75	15	103
JIS 30K - 20 mm (3/4 inch)	120	60	18	1	85	19	107
ANSI 150 - 20 mm (3/4 inch)	99	42.9	13	1.6	69.8	16	103
ANSI 300 - 20 mm (3/4 inch)	117	42.9	16	1.6	82.6	19	112
JPI 150 - 20 mm (3/4 inch)	99	42.9	13	1.6	69.8	16	103
JPI 300 - 20 mm (3/4 inch)	117	42.9	16	1.6	82.6	19	112

Please read "Terms and Conditions" from the following URL before ordering and use.
<http://www.azbil.com/products/factory/order.html>

Specifications are subject to change without notice.



Azbil Corporation
 Advanced Automation Company

1-12-2 Kawana, Fujisawa
 Kanagawa 251-8522 Japan
 URL: <http://www.azbil.com/>

1st edition: May 2008
 22nd edition: Mar. 2018

No part of this publication may be reproduced or duplicated without the prior written permission of Azbil Corporation.